

SONY

BETAMOVIE

BMC-110

OPERATING INSTRUCTIONS

Before operating the unit, please read this manual thoroughly, and retain it for future reference.



AVOID HIGH TEMPERATURES

Do not leave in a place exposed to direct sunlight, inside a closed car in the summer time or near heat sources.

This unit can be used with any video cassette tapes having the mark **B**.

WARNING

To prevent fire or shock hazard, do not expose the unit to rain or moisture.

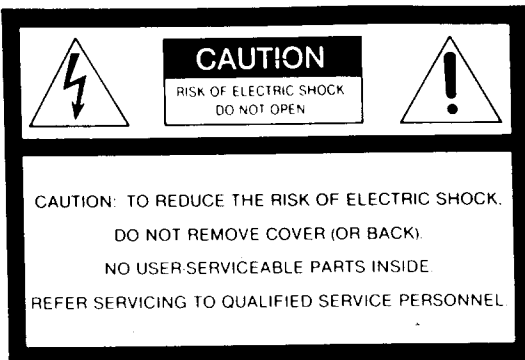

This symbol is intended to alert the user to the presence of uninsulated "dangerous voltage" within the product's enclosure that may be of sufficient magnitude to constitute a risk of electric shock to persons.



This symbol is intended to alert the user to the presence of important operating and maintenance (servicing) instructions in the literature accompanying the appliance.

This equipment generates and uses radio frequency energy and if not installed and used properly, that is, in strict accordance with the manufacturer's instructions, may cause interference to radio and television reception. It has been type tested and found to comply with the limits for a Class B computing device in accordance with the specifications in Subpart J of Part 15 of FCC Rules, which are designed to provide reasonable protection against such interference in a residential installation. However, there is no guarantee that interference will not occur in a particular installation. If this equipment does cause interference to radio or television reception, which can be determined by turning the equipment off and on, the user is encouraged to try to correct the interference by one or more of the following measures:

- reorient the receiving antenna
- relocate this equipment with respect to the receiver
- move this equipment away from the receiver
- plug the ac power adaptor into a different outlet so that adaptor and receiver are on different branch circuits.

If necessary, the user should consult the dealer or an experienced radio/television technician for additional suggestions. The user may find the following booklet prepared by the Federal Communications Commission helpful:

"How to Identify and Resolve Radio-TV Interference Problems".

This booklet is available from the U.S. Government Printing Office, Washington, DC 20402, Stock No. 004-000-00345-4.

LOCATION AND FUNCTION OF PARTS AND CONTROLS

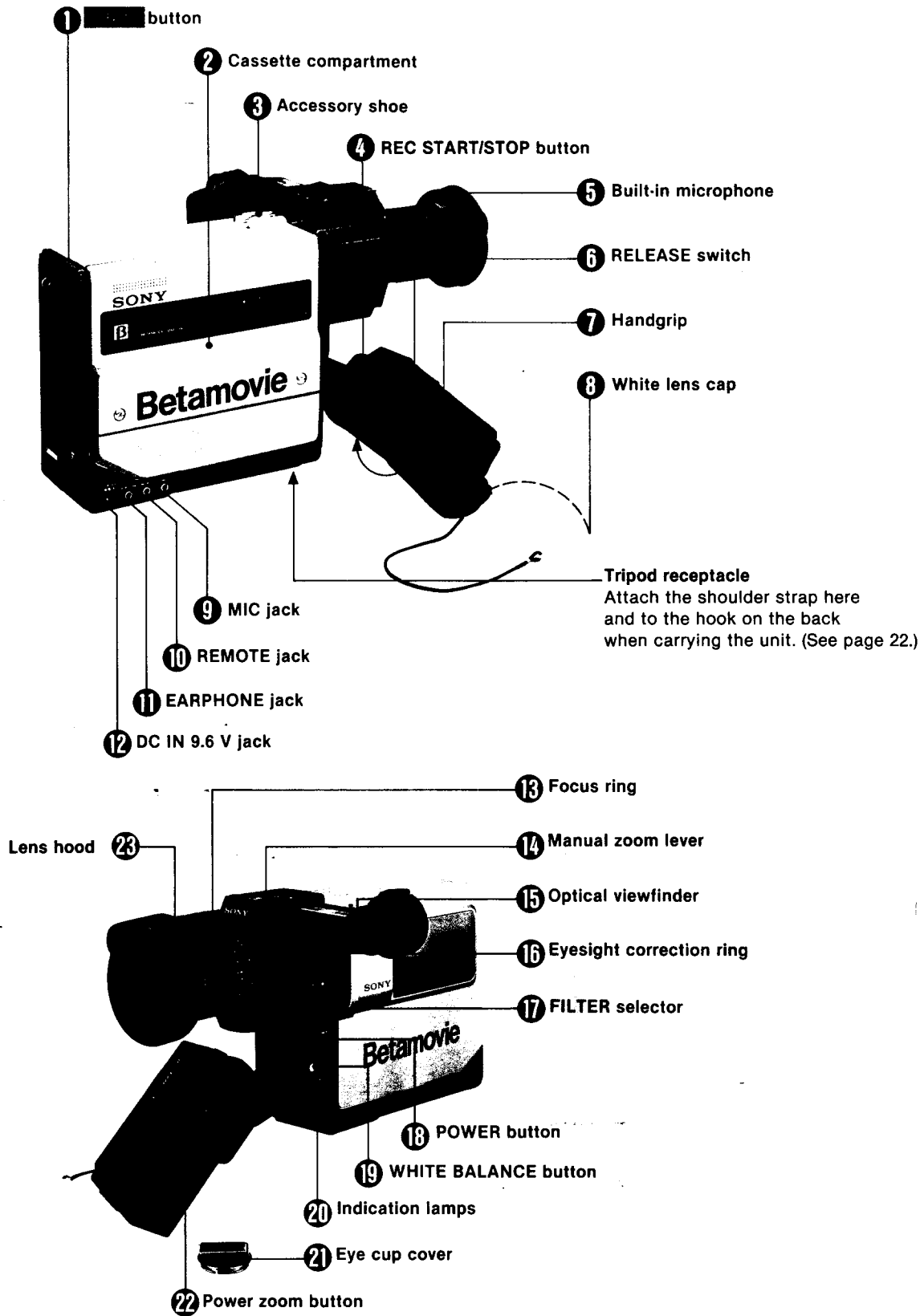

1 EJECT button

Slide down to open the cassette compartment. (p. 7)

The button does not operate when the power is not supplied or the battery power is exhausted.

2 Cassette compartment

Insert the cassette here. (p. 4)

If a cassette is not loaded, no function except the  button will work.

3 Accessory shoe

For attachment of an external microphone (with a SAD-100 external microphone shoe). (p. 21)

4 REC START/STOP button

Press to start recording, press again to stop. (p. 6)

5 Built-in microphone

Sound is recorded simultaneously with video taping. (p. 18)

6 RELEASE switch

Slide to unlock the hand grip. Hand grip angle can be set in one of three positions. (p. 5)

7 Hand grip

Comfortable grip that also holds the battery pack. (p. 4)

8 White lens cap

Snap onto the hand grip belt when shooting. Place on the lens hood when the unit is not in use, or to adjust the white balance.

9 MIC jack

For connection of an external microphone. The built-in microphone is automatically disconnected. (p. 32)

10 REMOTE jack

For connection of an optional Betamovie Commander to control the unit from a distance. (p. 20)

11 EARPHONE jack

For connection of the supplied earphone to monitor the sound being recorded. (p. 6)

12 DC IN 9.6 V jack

For connection of an ac power adaptor or car battery cord. The internal battery power is automatically disconnected. (p. 13)

13 Focus ring

Turn the ring to focus while looking through the viewfinder. (p. 11)

14 Manual zoom lever

Use the zoom lever to turn the zoom ring manually between W(wide-angle) and T(telephoto) positions. (p. 18)

For close-ups, turn the knob of the lever in the direction of arrow, then turn the lever counter-clockwise until the ring is in the **MACRO** position. (p. 19)

15 Optical viewfinder

Place your right eye here so that the lens' full field of view can be seen.

It is possible to focus the lens with the power off. The letter lamps inside the viewfinder indicate all the information necessary for operation.

W: Lights steady when the white balance needs adjustment. (p. 9)

Blinks during adjustment.

T: same as the TAPE/BATT indication lamp. (item 20)

C: same as the CAUTION indication lamp. (item 20).

L: Lights when the light level is too low. (p. 8)

16 Eyesight correction ring

Adjust to your eyesight to assure good focus. (p. 10)

Be sure to adjust when shooting for the first time.

17 FILTER selector

Set to the proper position in accordance with prevailing light conditions. (p. 8)

: Sunlight (outdoors or indoors)

: Incandescent lamps, fluorescent lamps or photo-flood lamps (indoors)

18 POWER button

Press to adjust the white balance or to set the standby mode for immediate recording starts. (p. 7) The **STANDBY** lamp will light.

Press again and the lamp goes off.

19 WHITE BALANCE button

Press to adjust the white balance with the white lens cap on, after setting the **FILTER** selector. (p. 9)

20 Indication lamps

TAPE/BATT : Lights steady when the tape is running.

Blinks when the battery is exhausted. Replace the battery pack. (p. 12)

DEW : Lights when moisture has condensed inside the unit. Eject the cassette and let the Betamovie sit until the moisture evaporates. The unit can be used again if the light does not come on when the cassette is reinserted. (p. 14)

CAUTION : Blinks when the video head becomes clogged or dirty. Clean the video head with a Sony L-25CL video head cleaning cassette. (p. 17, 25)

Lights steady when the unit is out of order. Contact the nearest Sony dealer or local Sony service facility.

21 Eye cup cover

Attach to the viewfinder eye cup when remotely controlling the unit. (p. 20)

Attach to the shoulder strap when not in use.

22 Power zoom button

Press for smooth power zooming between the W(wide-angle) and T(telephoto) positions. (p. 18)

23 Lens hood

Usually attached to the Betamovie. Remove when shooting close-ups or using an optional filter. (p. 19, 35)

RECORDING

Operation is easy and practice shooting will help you to become familiar with the procedures.

Preparations

1 Install a charged battery pack, NP-11 (supplied). p.12

- 1 Slide the **RELEASE** switch up to bring down the hand grip.
- 2 Turn the **BATTERY** knob to **OPEN**, and open the lid.
- 3 Insert a battery, close the lid and turn the knob to **CLOSE**.

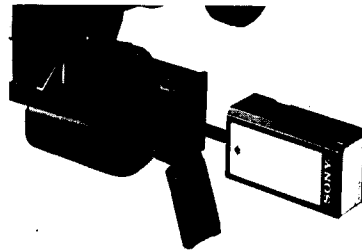
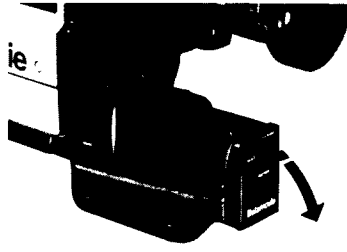
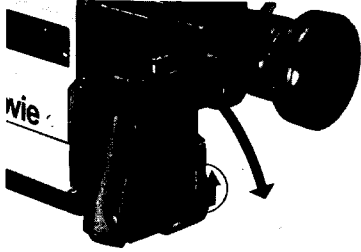

2 Install a cassette (with the safety tab). p.13

- 1 Slide the **EJECT** button down to pop up the compartment lid.
- 2 Insert a cassette with the round window to the right and push down to settle.
- 3 Press the upper left side of the compartment lid to close.

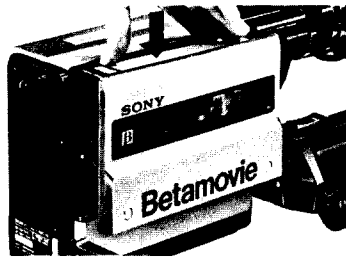
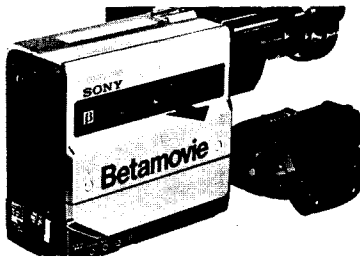

The letter lamps inside the viewfinder

The lamps blink or light steady to indicate all the information necessary for operation.

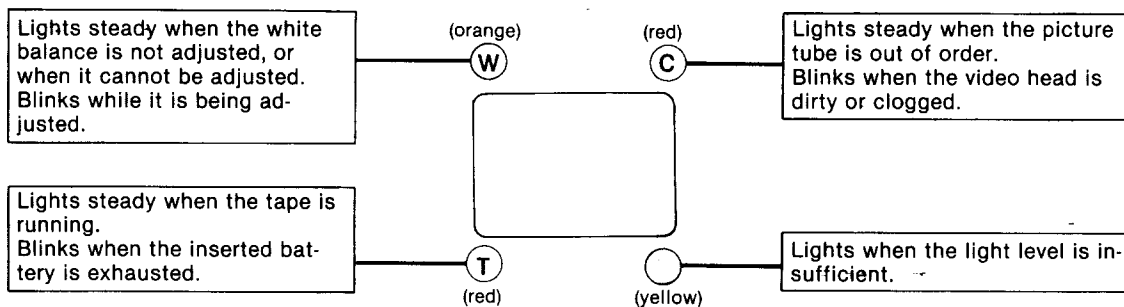

All the lamps light up at first when the **POWER** or **REC START/STOP** button is pressed.

Operation Betamovie is only for recording.
For tape duplication, two other VCRs are required.

1 Set to the standby mode.

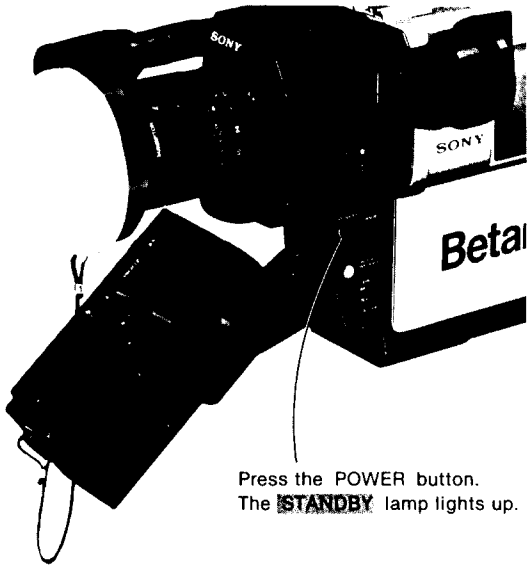

2 Adjust the white balance.

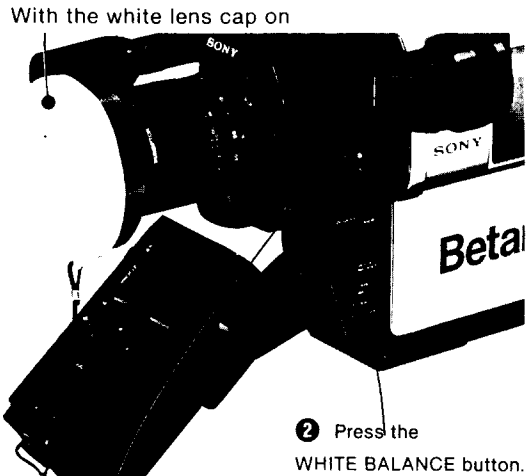

1 Set the FILTER selector according to the prevailing light condition.

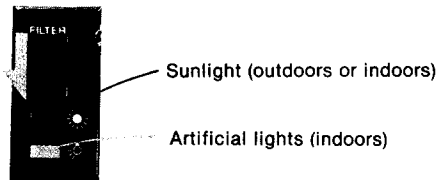

The "W" goes off when adjusted.
In the viewfinder

When you press the WHITE BALANCE button immediately after pressing the POWER button, the white balance may sometimes not adjust. In that case, press the WHITE BALANCE button again.



1 Lock the hand grip into a position.

Hand grip
Select a convenient angle.

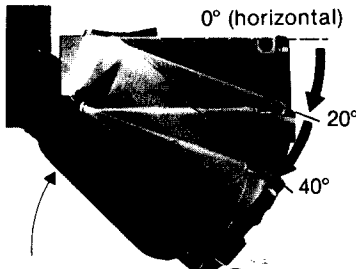

- 1** Slide the **RELEASE** switch to unlock and bend.
- 2** Release to lock at the desired angle.

2 Place your right hand under the grip belt and grasp the grip.

Grip belt
Adjust the length. (A tight belt makes operation easier.)

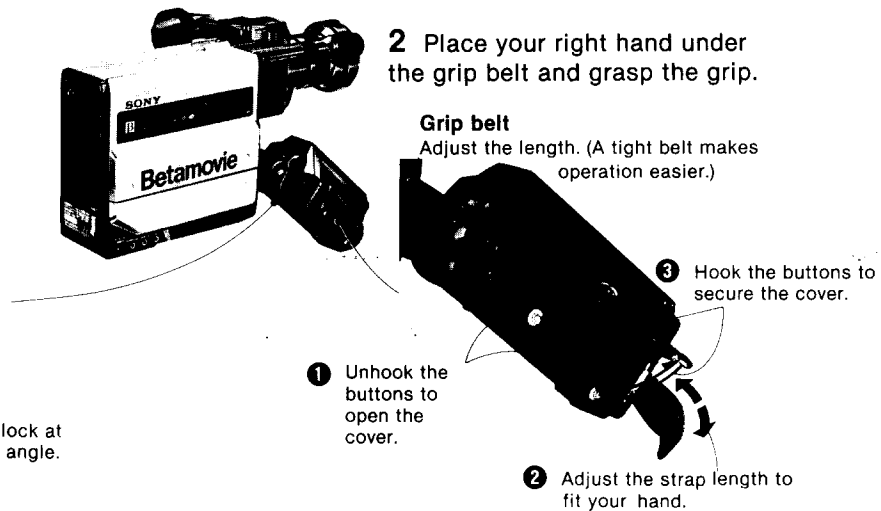

3 Focus

Adjust the eyesight correction ring to your eye, when using for the first time or after another person. (See page 10.)

Remove the white lens cap.

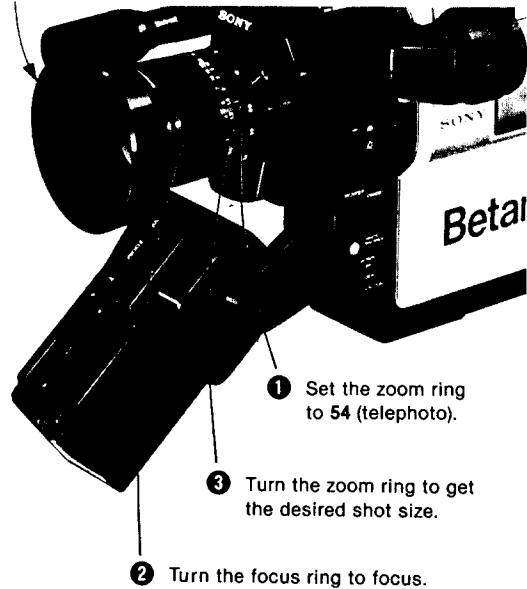

4 Start recording

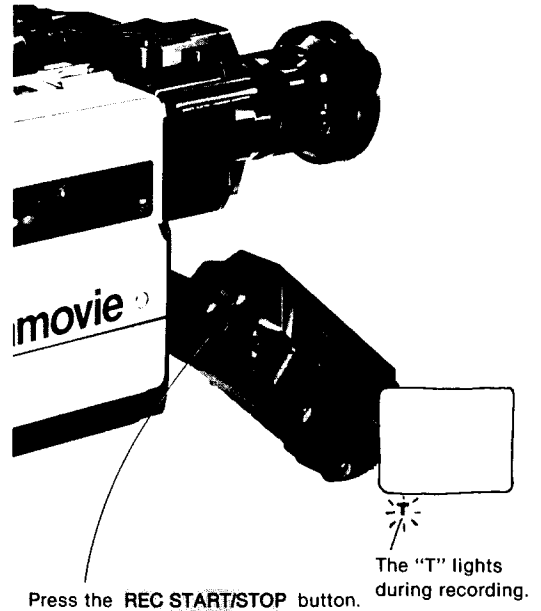

To stop recording momentarily

Press the REC START/STOP button again.

The **STANDBY** lamp is lit.

The unit is automatically turned off (the **STANDBY** lamp goes off) when it is in the standby mode over 3 minutes.

Monitoring the sound being recorded.

Plug the supplied eaphone into the **EARPHONE** jack and listen during recording.



3 Put the Betamovie on your shoulder, and put your right eye on the viewfinder eye cup.

Viewfinder

Fold down into operating position.

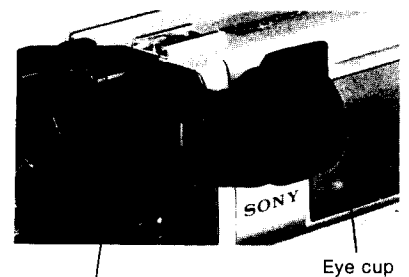
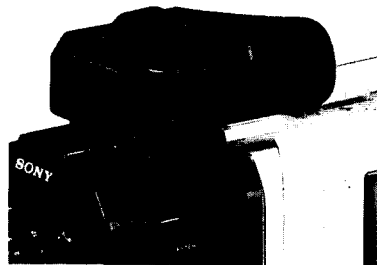

Lock into position securely.

Resting the Betamovie on your shoulder helps to keep it steady for shooting.

To start recording again

Press the **REC START/STOP** button again.

While the **STANDBY** lamp is lit....

Recording starts immediately.

After the **STANDBY** lamp goes off....

Recording starts after about 3 seconds.*

*It takes about 3 seconds for the picture tube warm-up before recording.

When you wish to start recording immediately, press the **POWER** button to set the Beta movie in the standby mode (the **STANDBY** lamp is lit.)

The battery power is also consumed in the standby mode as much as in the recording mode.

Smooth recordings can be made even if the recording is stopped and started again, unless the cassette is taken out.

5 Remove the recorded cassette.

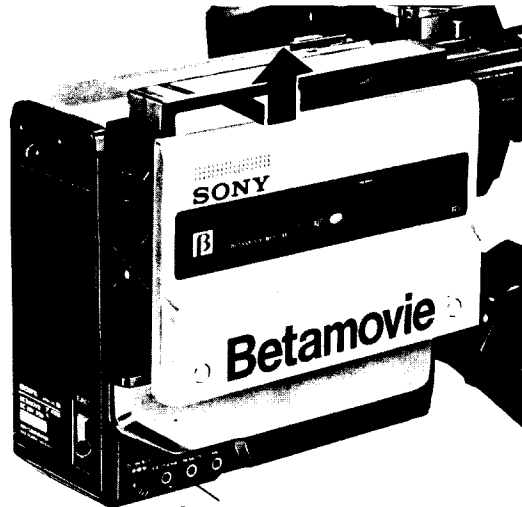

Press the **EJECT** button.

If the battery power is exhausted and the compartment lid cannot be opened, replace with a charged battery or connect with an ac power adaptor.

Run the tape for about 25 seconds at the beginning of a cassette before starting recording. Otherwise you may miss the starting point during playback when the tape is played back on video cassette recorders.

For "once-only" events such as weddings etc., it is strongly recommended to have a trial run to check that everything is working perfectly.

Take out the battery pack.

Hold the unit with the hand grip lid pointing up to open the battery compartment. Never point the lid downward as the battery pops out.

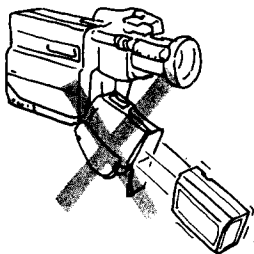

Charge the battery for the next use.

Playback of the tape

A video cassette recorder and a TV are required.

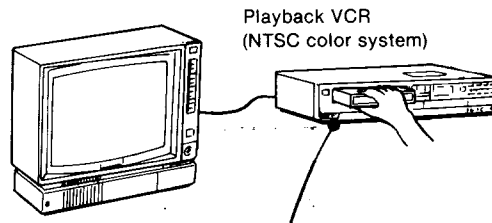

If streaks or snow appear on the TV screen, adjust the **TRACKING** control of the VCR for the best possible picture.

For details, refer to the instruction manual of the VCR.

THREE POINTS TO CONSIDER WHEN SHOOTING

POINT 1

LIGHTING AND LIGHT DIRECTION

Is the subject sufficiently lighted? Actually, because the Betamovie uses Sony's SMF Trinicon® tube, recording can be done without special lighting. But for the best results, there are times when additional lighting is necessary.

When the light level is too low, the letter "L" will light in the viewfinder; increase the light level as necessary. The warning indicator will go out when the light level is satisfactory.

(For further details, refer to the section entitled "Lighting" in the HINTS FOR BETTER RECORDING section, page 31.)

In the viewfinder



Generally, recording should be done with the sun at your back (front-lighting). This will illuminate the subject naturally and provide the best results from the very beginning of your recording.

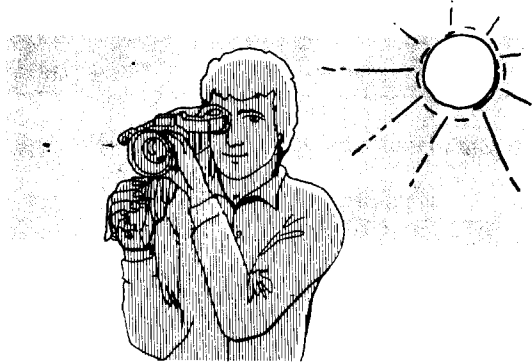

It is also possible to record with the sun behind your subject (back-lighting), but this technique is more likely to produce less than satisfactory results until you become proficient. Front-lighting usually provides better results unless you're trying to create special effects.

For further details, refer to the section "Brightness levels" in the HINTS FOR BETTER RECORDING section on page 35.

POINT 2

WHITE BALANCE

Because Betamovie uses an optical viewfinder, the image you see in it is usually the same color as that of the subject. This is not always the case with the image being recorded, however, because of the fact that the color of the subject can be affected by the color temperature of the ambient light. The human eye has the ability to adapt to this situation, but a video camera does not. So to compensate for light temperature variations, the white balance control is used.

(See "Color temperature" in the HINTS FOR BETTER RECORDING on page 35.)

White balance adjustment

First, set the FILTER to the appropriate ambient light position, depending on the most dominant light source.



(blue) Recording outdoors in sunlight

(yellow) Recording indoors in incandescent or fluorescent light

If the camera is indoors but the subject being recorded is in a window or outdoors, set the switch to the ☀ position.

Recording indoors, but with sunlight as the dominant light source.

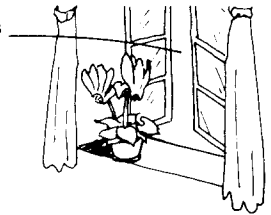
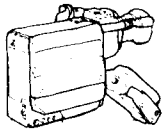

With the FILTER set and the white lens cap in place on the lens hood, aim the lens at a light source (indoors) or a subject from a distance of at least two meters (outdoors). Then merely press the **WHITE BALANCE** button and the white balance will be perfectly adjusted automatically.

When adjusting white balance outdoors, more accurate adjustment can be made by setting the white balance in accordance with the light conditions the subject will be taped under. For example, if the subject will be taped in sunlight, **put the white lens cap on the lens hood** and point the camera toward the sun. If the subject will be taped in shadows, white balance should also be adjusted in shadows. When white balance adjustment is completed the "W" lamp in the viewfinder will go off.

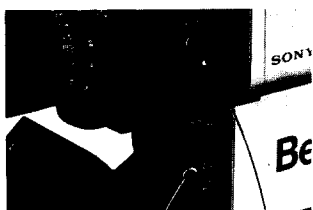

Two

One

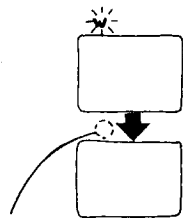

Adjustment completed

Cautions on white balance adjustment

Losing white balance adjustment

The white balance adjustment is preserved for about 30 minutes after the power is turned off. If the power is off for more than 30 minutes, or if the FILTER selector position is changed, the white balance adjustment will be lost and the "W" lamp will light when the power is turned on. Set the white balance adjustment again as outlined above.

"W" lamp stays on after the WHITE BALANCE button is pushed.

- Adjustment cannot be made because of insufficient light (the "L" lamp will also light.)
- Adjustment cannot be made because of the presence of certain types of light, such as neon signs or tunnel lights.

Even if the "W" lamp does not go off, the white balance is nearly perfectly adjusted by the position of the FILTER selector, so recording is still possible.

Changing light sources

Because lighting remains basically the same for a given source, the white balance adjustment does not need to be changed very often. However, if a major light source change is made, such as from outdoor to indoor shooting, the white balance will have to be readjusted.

POINT 3

FOCUS

The first time you use the Betamovie, or if somebody else has been using the Betamovie, be sure to set the focus of the eyesight correction ring to your eyesight before recording.

Eyesight adjustment

To properly use the optical viewfinder, it is first necessary to set the eyesight adjustment.

The distance of optimum vision varies from person to person, and the eyesight correction ring is incorporated to compensate for this. If this adjustment is not correct for the user, it is likely that the recorded images will not be in focus.

Using a subject

1. Set the zoom ring to 54 (telephoto) and the focus ring to ∞ (infinity).
2. Center a distant subject (at least 150 meters away) in the viewfinder.
3. Turn the eyesight correction ring until the clearest image of the subject is obtained.

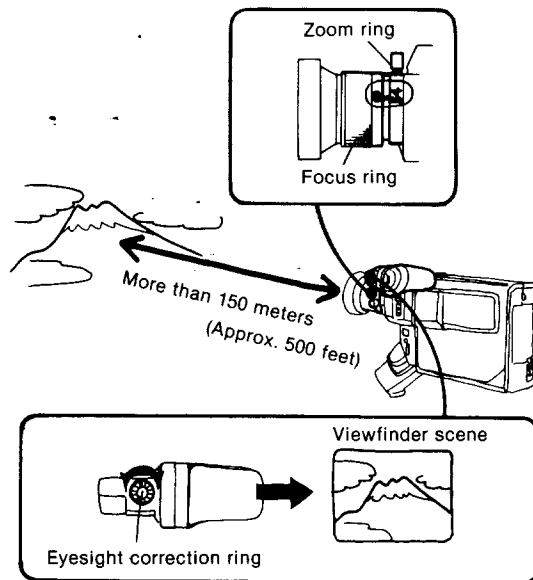

Using the viewfinder frame

When a subject cannot be taken from a distance, such as in a room, etc.

1. Aim the Betamovie at a brightly-lit solid color object.
2. Turn the eyesight correction ring until the viewfinder frame is in focus.

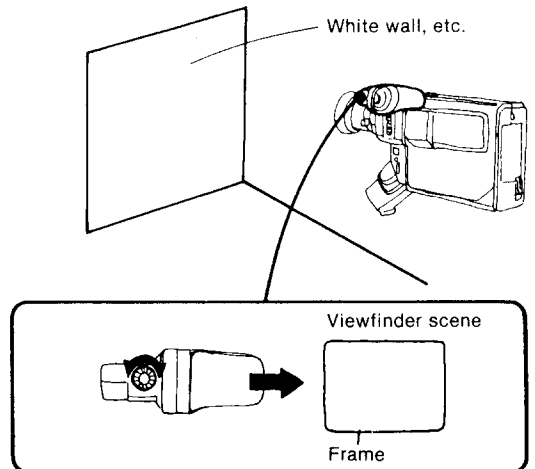

You will find it useful to remember the setting of the eyesight correction ring so that you can easily reset it should the position be changed.

It does not matter how many times the ring is rotated to the left or right: the only thing that matters is the position of the mark on the ring.

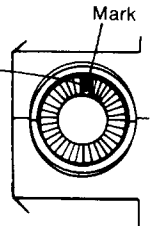

Focusing

For proper focusing, always be sure that the eyesight adjustment is correct before recording.

To focus, first make the subject as large as possible in the viewfinder by using the telephoto lens setting. After the focus is set, the subject will remain in perfect focus regardless of the zoom setting.

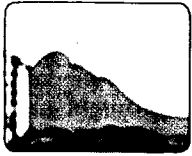

Turn the zoom ring all the way to the right to make the subject as large as possible in the viewfinder.

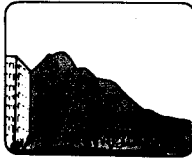

Focus by turning the focus ring.



Set the desired shot length using the zoom ring.

Focusing with the lens in wide angle can lead to shots being out of focus.

This is because the focusing field is wider in wide angle than in telephoto, making it harder to achieve sharp focus.

Some helpful hints

- When shooting a scene with lots of movement in bright light, set the focal length to 2 m and the zoom to wide angle. The scene will remain in good focus regardless of the movement of the subject.
- If you don't have time to set the focus properly, set it to the closest approximate position and set the lens at wide angle to avoid out-of-focus shots.
- When shooting in low light situations, such as indoors, the depth of field for proper focus becomes very shallow. For best results, set the focus in telephoto (54 on the lens' focal length indicator) and shoot at wide angles (between 30-9).

NECESSITIES FOR RECORDING

POWER SOURCE **Select one of the three depending on the situation**

Anywhere

BATTERY PACK (supplied)

A battery pack contributes best to the portability and compactness of the Betamovie.

The operating time is one hour with a supplied NP-11 on continuous use.

Be sure to charge the battery pack before every use.

How to charge

The AC-M110 ac power adaptor (supplied) is required.

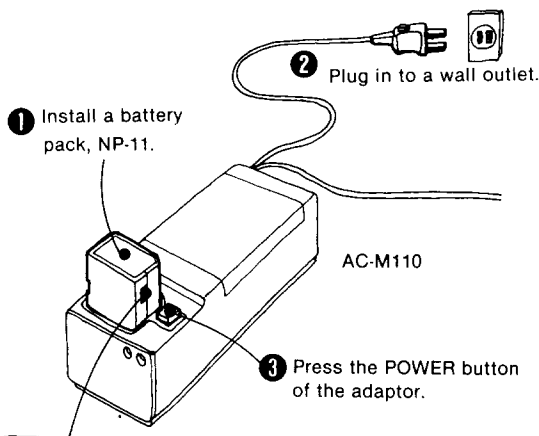

When the battery has been fully charged

Set the FULL/EMP indicator to **FULL**.

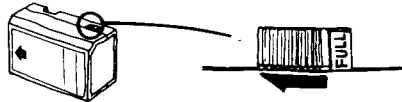

- If the battery pack is not fully charged or if it is used in a cold place, the operating time is shortened.
- The battery power is being used even in the standby mode. For outdoor shooting, you should carry extra battery packs to provide 2 or 3 times of the recording time you anticipate.

When to replace a battery pack

When the battery is being exhausted, the TAPE/BATT lamp or the "T" lamp in the viewfinder begins to blink slowly (1/1 sec.). Take the battery pack out and charge it or replace it with a charged one.

If you continue to use the exhausted battery, the unit is automatically turned off and recording stops. Then the lamp keeps blinking quickly (5/1 sec.) for about 30 seconds.

If a charged battery is replaced after the lamp has stopped blinking, the lamp might start blinking again. If this happens, take the battery out and insert it again.

When the battery is exhausted

Set the FULL/EMP indicator to **EMP**.

The indicator will tell you at a glance the condition of battery.

To recognize a battery pack

Attach the supplied numbering decal from **1** to **5** on your battery packs.

CASSETTE

VIDEO CASSETTE TAPES (optional)

Select a cassette according to the recording time.

(The tape speed of the Betamovie is **II**.)

| Cassette used | Recording time |
|---------------|----------------|
| L-125 | 30 min. |
| L-250 | 1 hr. |
| L-500 | 2 hr. |
| L-750 | 3 hr. |
| L-830 | 3 hr. 20 min. |

The cassette safety tab on the bottom

When a new recording is made on a previously recorded cassette, the previous recording will be automatically erased.

To avoid erasing a recording

Break off the safety tab using a screwdriver or similar object.



To re-record on a cassette which has had its safety tab removed

Cover the hole with a piece of plastic tape.

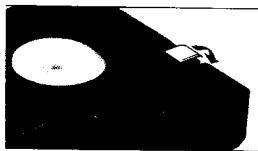

Make sure that a cassette to be recorded has a safety tab or a piece of tape over the opening.

With a wall outlet

AC POWER ADAPTOR (supplied)

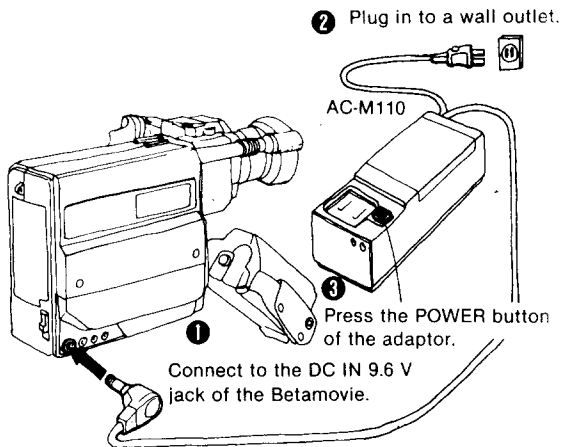

- When an adaptor is connected to the Betamovie, the internal battery power is automatically disconnected.
- If a battery pack is installed in the adaptor, power will not be supplied to the Betamovie through the adaptor cable.

In a car

CAR BATTERY CORD (optional)

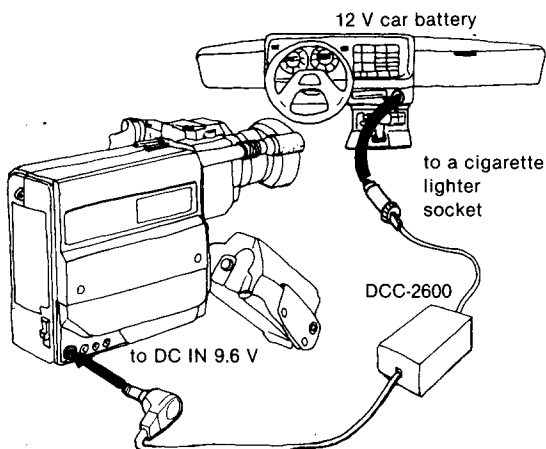

For details, refer to the instruction manual of the DCC-2600.

NOTES ON MOISTURE CONDENSATION

If the Betamovie is brought directly from a cold to a warm location, moisture may condense on the drum assembly inside the unit. In this condition, the tape may have a tendency to adhere to the head drum.

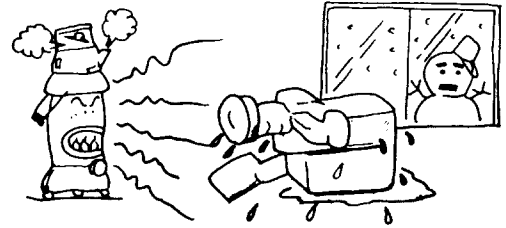

To prevent possible damage under these circumstances, the recorder is furnished with a moisture sensor. If moisture is present, the sensor will activate to prevent operation and the DEW lamp will light. No function button except the [REDACTED] button will work.

Moisture on the lens

If the image you see in the viewfinder is blurred with moisture, turn off the Betamovie and wait until the moisture evaporates. The DEW lamp does not light.



Beta

Slight moisture condensation

Vapor is apt to condense in low temperatures (around 0°C or 32°F), and may cause a condition of moisture condensation but not enough to cause the DEW lamp to light. The picture on a tape recorded under these conditions may be distorted.

If the DEW lamp lights, moisture has condensed inside the unit.



Eject the cassette and let the Betamovie sit until the moisture evaporates.

The DEW lamp is lit for about 30 seconds and goes off.

When to use

The Betamovie can be used again if the light does not come on when a cassette is inserted. If the cassette pops out when inserted, leave the unit for another while since the moisture has not yet evaporated.

How to record with smooth transitions between scenes

If a cassette is ejected and reinserted during recording, a blank part is produced between the pre-recorded portion and the next one. This is because the tape moves forward on cassette ejection and insertion.

To eliminate the blank part, rewind the tape back the same distance as the tape has moved forward. In this way, the next recording overlaps the end of the pre-recording eliminating the blank space and providing a smooth recording transition.

The length to rewind

It depends on the cassette type, the remaining amount of the tape or the playback VCR, but is approximately 35–40 cm (14–16 inches).

How to rewind the tape back

1. While pressing the lock lever on the back of the cassette with a pencil or similar object, open the cassette lid.

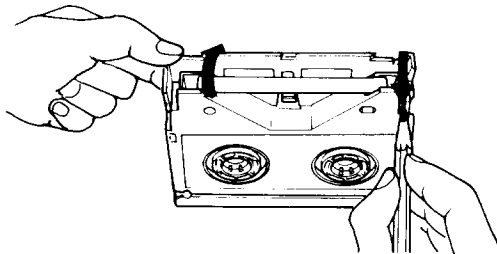

2. Turn the cassette reels clockwise, in turn to rewind the tape with the lid open.

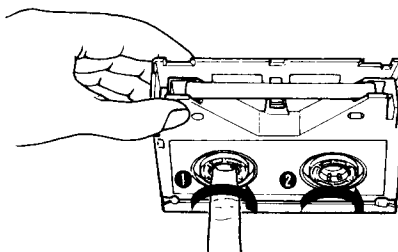

3. Make sure that the tape is in the right position without slack, then close the lid.

The tape should be above.

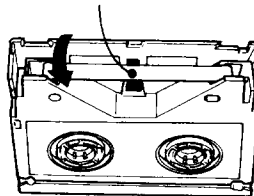

Never touch the tape directly with your fingers.

Notes

- When a new recording is made on the re-rewound tape, the last part of the pre-recording may be erased. (10 seconds at max.)
- During playback, color bars may appear on the overlapped part of the pre-recording and the next recording.

IMPORTANT REMINDERS

Avoid high temperatures

The Betamovie is equipped with a 1/2-inch SMF Tricon tube.

To maintain the performance of the SMF Tricon tube, do not leave it or continuously use it in the following locations.

- In places over 40°C (104°F) for operation
- **In places over 50°C (122°F) for storage**
- Locations exposed to direct sunlight or strong bright lights
- Inside a car with doors and windows closed or a car trunk
- Locations near heat sources

Avoid burning the pickup tube

If a strong bright light enters the pickup tube, it may cause severe damage to the tube. For protection, attach the white lens cap when it is not in use.

- Never point the camera directly into the sun or bright lights
- Avoid continuous shooting of lamps or of a subject in a strong light
- Avoid prolonged exposure to a subject even in a dim light with dark background
- Place the white lens cap on the lens hood on cassette insertion and ejection

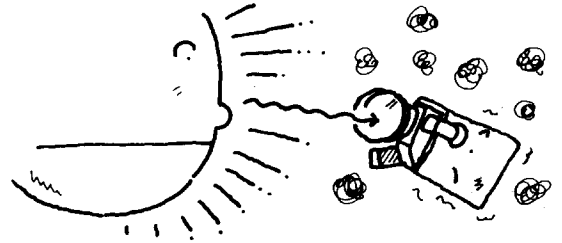

When a light leaves a trail on the playback picture, the tube may be suspected of having burn damage. A slight burning is cured when it is left with the power off for a night. If the burning still remains, contact the nearest Sony dealer or local authorized Sony service facility.

When the Betamovie has not been used for a long period of time

Operate the Betamovie for a few minutes at least once every 6 months. While test shooting use the zoom and focus ring too. Otherwise the Tricon tube and the internal units may deteriorate through disuse.

VIDEO HEAD CLEANING

After the Betamovie has been used for an extended period of time, the video head may become contaminated and require cleaning. The Betamovie is furnished with a video head detector and the lamp lights to indicate when to clean.

If the **CAUTION** or "C" lamp inside the viewfinder blinks at the beginning of the recording, when the **REC START/STOP** button is pressed, the video head may be contaminated or clogged.

Repeat starting and stopping recording by pressing the **REC START/STOP** button several times, and the lamp may stop blinking. Then you can start recording as usual. When the lamp keeps blinking, proceed as follows:

Clean the video head with the Sony L-25CL video head cleaning cassette (optional). For details about cleaning, refer to the instructions furnished with the cleaning cassette.

If the lamp still blinks even after cleaning, contact the nearest Sony dealer or local Sony service facility.

USEFUL CONVENIENCE FUNCTIONS

Sound recording (Simultaneous audio/video)

Sound is recorded simultaneously with the video portion through the built-in microphone. Because this mic is a uni-directional type, precise recording of the scene's subject is possible.

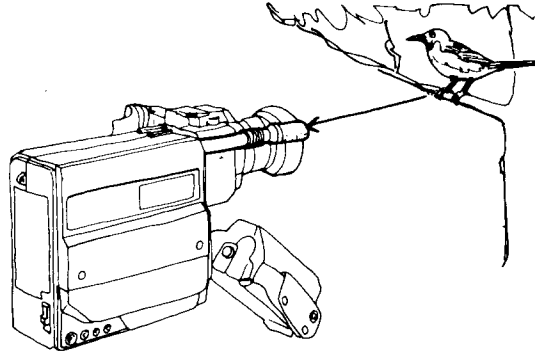

Betamovie monaural sound recording.

When to use an external microphone

The built-in mic is convenient for isolating the subject to achieve satisfactory recording under most conditions. However, if you are concerned about extraneous sounds being recorded, such as Betamovie operation or wind noises, using one of the various types of external mics available will allow you to achieve superior results.

(See HINTS FOR BETTER RECORDING on page 32.)

The scene during recording (Zooming)

Zooming allows you to change the size of the subject in the scene, allowing you to emphasize it or define it as part of a larger scene. Betamovie allows convenient zooming in two ways—by hand, using the zoom lever, or automatically, using the power zoom button.

When zooming by hand, move the zoom lever manually.

When power zooming, push either the T (telephoto) or W (wide-angle) side of the power zoom button, and the zoom ring will move automatically.

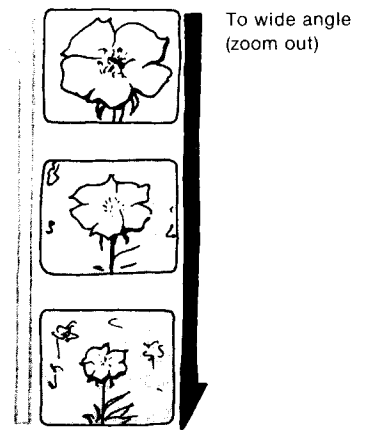

Hand-controlled zooming

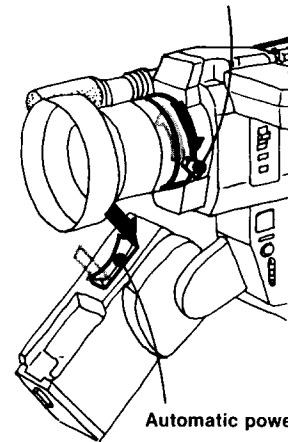

For more details on the use and effects of zooming, refer to HINTS FOR BETTER RECORDING, page 29.

Close-ups (macro)

During normal recording, the closest the Betamovie can get to the subject and stay in focus is about 80 cm to 1 m. Use of the macro function, however, allows the Betamovie to approach the subject almost to the lens, so that even tiny objects can literally fill the screen for dramatic close-up effects. This allows you to discover aspects of the subject that would otherwise be "impossible".

1. Turn the manual zoom lever to the **MACRO** position.
2. Select the subject size in the scene by changing the distance between the subject and lens.
3. Focus by turning the zoom lever.

Turn the knob in the direction of the arrow, then turn the zoom ring.

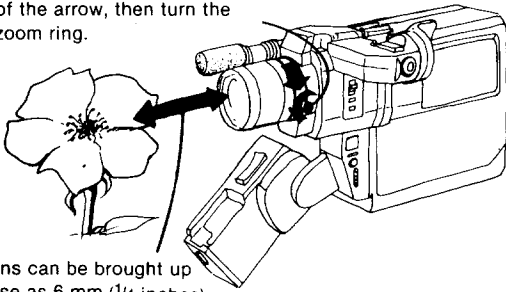

The lens can be brought up as close as 6 mm (1/4 inches) of the subject.

How to remove the lens hood

Because the camera will be positioned very close to the subject, the lens hood should be removed.

Place the palm of your hand on the lens hood and turn in a counter-clockwise direction.

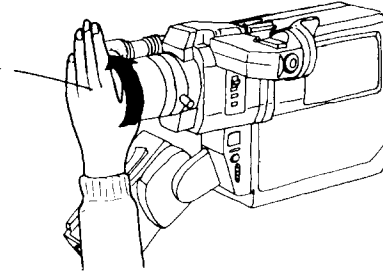

Notes on macro recording

- When shooting in macro, the depth of field is very shallow, so pay careful attention to eyesight adjustment and focus.
- Zooming is not possible during macro recording. To change the size of the subject, move the lens closer or further away from it.

ACCESSORIES

4 types of power sources

NP-11 battery pack (supplied)

Delivers 1 hour of operating time. Rechargeable and easy to carry.

AC-M110 ac power adaptor (supplied)

Permits use of AC household current and recharges NP-11 in 1 hour.

DCC-2600 car battery cord

Turns your car battery into a power source.

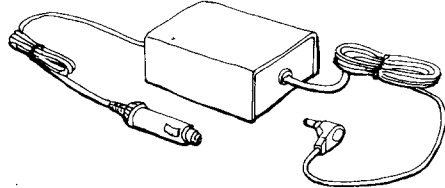

BP-400 battery belt (available in Spring)

Delivers about 4 hours of operating time while worn around your waist. Rechargeable with the supplied charger.

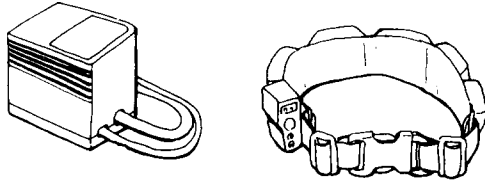

LC-710 Betamovie system case (available in early Spring)

Allows you to carry Betamovie, an ac power adaptor, two battery packs, two video cassette tapes and other useful accessories.

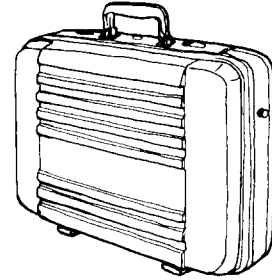

Remote control operation

RM-81 Betamovie Commander

Allows you to start and stop recording from a distance.

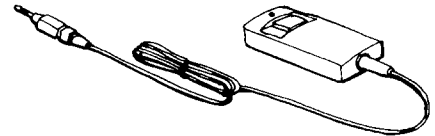

Protective holders for outdoor use

LC-720 Betamovie carrying case

Allows you to carry Betamovie and two battery packs.

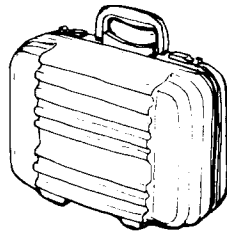

LC-810 Betamovie jacket

Protects Betamovie outdoors.

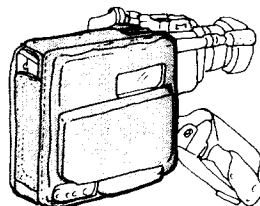

To cut the interfering light through the eye cup

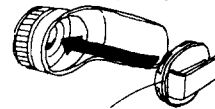

Attach the supplied eye cup cover.

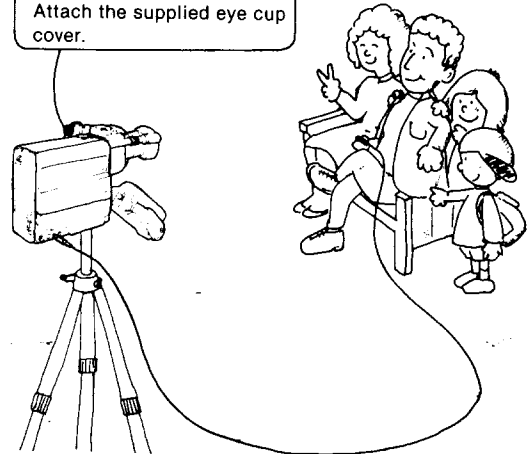

Sound recording

ECM-K100 electret condenser microphone
— supercardioid

Picks up a specific sound source while cutting the extraneous surrounding sound. A size AA battery (IEC designation R6) is used as a power source.

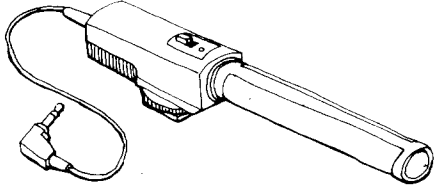

ECM-Z300 electret condenser microphone — zoom
Picks up sounds from a large area to a more restricted frontal area. A 9 V battery, size 6J22 (IEC designation) is used as a power source.

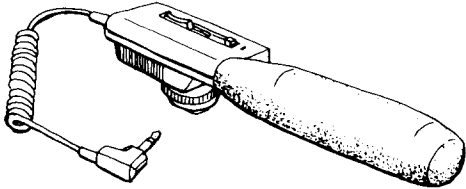

SAD-100 external microphone shoe

Recommended when mounting an external microphone, in order to reduce the operational sounds and vibrations from the Betamovie.

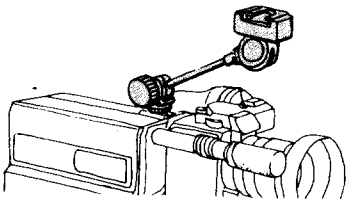

Cassette rewinding/erasing

BE-V50 video cassette rewinder/eraser

Useful for rewinding any Beta cassette tape to its beginning and quick/easy erasing of a recorded tape.

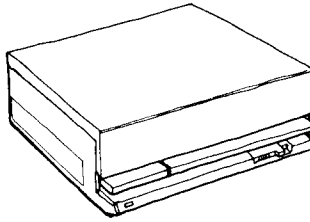

Stable shooting

VCT-150K tripod for video cameras

Heavy duty tripod for stable picture taping with smooth, well-balanced panning and tilting. Supplied with versatile carrying bag.

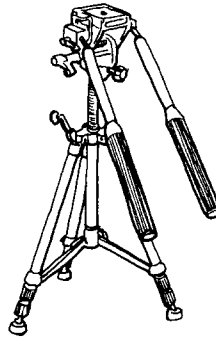

Cleaning

L-25CL video head cleaning cassette

Insert and run the tape for 30 seconds, so that the head will be cleaned.

For details refer to the instruction manual provided with the tape.



PRECAUTIONS

On safety

- Operate the unit only on 9.6 V dc. Use the power source recommended for this unit.
- Do not allow any solid object or liquid fall into the cabinet. It may cause a malfunction of the unit.



- Should any problem persist, have the unit checked by qualified personnel before operating it any further.

On operation

- Do not grab the lens ring or the viewfinder when carrying. When an excessive pressure is applied, it may cause a malfunction.
- Avoid rough handling or mechanical shock to the unit. Be particularly careful of the lens.

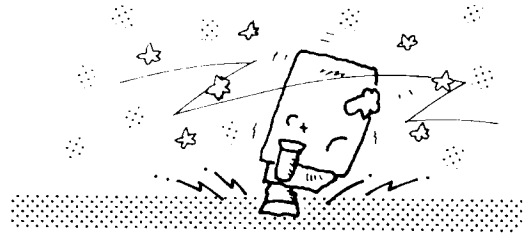

- Do not apply excessive force to the microphone, to prevent possible damage.
- Remove the cassette when the unit is not to be used for a long period of time. If a cassette is left inside, the tape may adhere to the head drum.
- When shooting in the rain, do not let the rain leak into the unit.
- When shooting by the beach, be careful not to let sea water or sand get into the unit.

When carrying

Attach a supplied shoulder strap to the Betamovie.

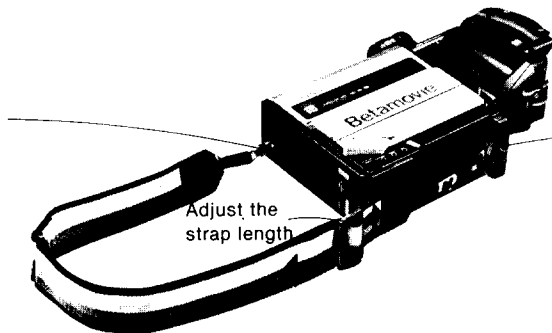
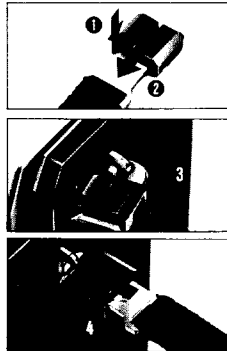

Fasten the screw.

On installation

- Allow adequate air circulation to prevent internal heat build-up.
- Do not install the unit near heat sources such as radiators or air ducts or in a place subject to direct sunlight, excessive dust, mechanical vibration or shock.



- Keep the unit and cassette tapes away from equipment with strong magnets, for example, a microwave oven or a large loud-speaker.

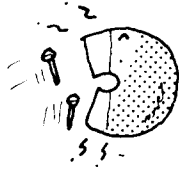

- Avoid placing the unit in places where it is exposed to radio-activity such as X-rays. This may damage the lens and electronic components.



- Never leave the unit in a closed car subjected to direct sunlight, nor point directly to the source of bright light. The picture tube may deteriorate and the plastics inside may warp.

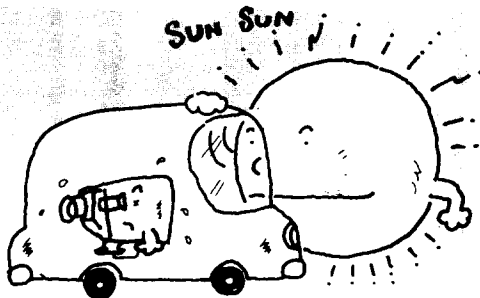

On cleaning

Clean the cabinet with a dry, soft cloth, or a soft cloth lightly moistened with a mild detergent solution.

Do not use any type of solvent, such as alcohol or benzine, because a solvent may damage the finish.

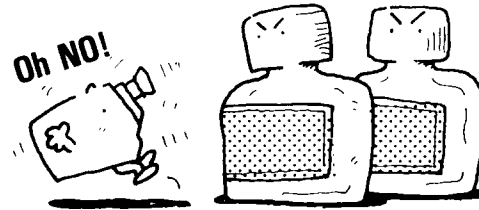

SPECIFICATIONS

System

| | |
|----------------------------|--|
| Video recording system | Rotary double-azimuth single-head, Helical scanning FM system |
| Usable cassettes | Cassettes having the mark B |
| Tape speed | 2.0 cm/sec. (18II) |
| Maximum recording time | 3 hours 20 min. (18II) (with L-830 video cassette) |
| Audio frequency response | 50–8,000 Hz (18II) (using an external microphone) |
| Pickup tube | 1/2-inch SMF Tricon tube |
| Lens | Combined 6x power zoom lens f9 mm (F1.2)–54 mm (F1.4) with macro Filter diameter: 52 mm |
| Color temperature selector | Built-in 2-step filter (3200°K/5500°K) |
| Minimum illumination | 28 lux |
| Illumination range | 28 lux to 100,000 lux (2.6 to 9294 footcandles), automatic sensitivity and iris |

Inputs and outputs

| | |
|------------------|---------------------------------------|
| DC IN 9.6 V jack | 9.6 V dc |
| EARPHONE jack | Minijack, –26 dBs, 8-ohm impedance |
| REMOTE jack | Minijack |
| MIC jack | Minijack, –65 dBs, Low impedance |

General

| | |
|-----------------------|---|
| Power requirements | 9.6 V dc |
| Power consumption | 9.5 W |
| Operating temperature | 0°C to 40°C (32°F to 104°F) |
| Dimensions | Approx. 125 × 220 × 357 mm (w/h/d) (w/h/d) (5 × 8 ³ / ₄ × 14 ¹ / ₈ inches) when packed |
| Weight | 2.48 kg (5 lb 7 oz) Betamovie only |
| Viewfinder | TTL optical system, Eyesight correction adjustable (+2 – –4 DP) |
| Microphone | Built-in electret condenser mic |
| Accessories supplied | Eye cup cover...1 Shoulder strap...1 Earphone...1 Decal...1 NP-11 battery pack...1 AC-M110 ac power adaptor...1 |

Design and specifications are subject to change without notice.

TROUBLE CHECKS

If you think you have a problem, double-check before calling the serviceman. You may have overlooked something relatively simple.

| Symptom | Cause | Procedure |
|--|---|--|
| The STANDBY lamp does not light even when the POWER button is pressed. | <ul style="list-style-type: none"> ● No cassette is inserted. ● The inserted battery pack is exhausted. ● The cassette safety tab is removed. ● The tape is at its end. | <ul style="list-style-type: none"> ● Insert a cassette. ● Take it out and charge, or replace with a charged one. ● Cover the hole, or insert a cassette with a safety tab. ● Rewind the tape on a VCR, or replace with a new cassette. |
| The function buttons cannot be activated. A cassette cannot be inserted. | <ul style="list-style-type: none"> ● The DEW lamp is lit. | <ul style="list-style-type: none"> ● Eject the cassette and let the unit sit until the moisture evaporates. |
| The tape does not run when the REC START/STOP button is pressed. | <ul style="list-style-type: none"> ● The tape is stuck to the head drum. ● The tape is at its end. | <ul style="list-style-type: none"> ● Eject the cassette and insert it again. ● Rewind the tape on a VCR, or replace with a new cassette. |
| The CAUTION or "C" lamp in the viewfinder blinks. | <ul style="list-style-type: none"> ● The video head may be contaminated or clogged. | <ul style="list-style-type: none"> ● Repeat pressing the REC START/STOP button several times. If the lamp still blinks, use an optional Sony L-25CL video head cleaning cassette. If the blinking persists, contact the nearest Sony dealer or local Sony service facility. |
| The CAUTION or "C" lamp in the viewfinder is lit. | <ul style="list-style-type: none"> ● The unit has not been used for a long period of time. ● While the cassette is being inserted or ejected. | <ul style="list-style-type: none"> ● Run the tape for a while, and the lamp may go out. If the lamp continues to light for more than 5 minutes, contact the nearest Sony dealer or local Sony service facility. |
| The white balance cannot be adjusted. (The "W" lamp in the viewfinder stays on.) | <ul style="list-style-type: none"> ● Light is insufficient. (The "L" lamp in the viewfinder is also lit.) ● Under certain types of light. | <ul style="list-style-type: none"> ● Add lighting. ● Recording can be made. |
| The cassette cannot be ejected. | <ul style="list-style-type: none"> ● The internal battery power is exhausted. ● The power connection is not properly made. | <ul style="list-style-type: none"> ● Replace with a charged battery pack. ● Connect an ac power adaptor or a car battery cord firmly. Turn on the ac power adaptor. |
| The playback picture is not clear. | <ul style="list-style-type: none"> ● Focusing was not properly done. | <ul style="list-style-type: none"> ● Set the eyesight adjustment before focusing. |
| Another image appears in the center of the playback picture. | <ul style="list-style-type: none"> ● The light went through the viewfinder when recording from a distance. | <ul style="list-style-type: none"> ● Attach the eye cup cover to the viewfinder eye cup when remotely controlling the unit. |

HINTS FOR BETTER RECORDING

The key to success—practice makes perfect!

Record over and over using the same tape...
see what you've recorded on TV as soon as you're finished...
these are just two of the advantages of video recording.
The more you use your Betamovie, the better you'll get!
Once you've mastered each phase of operation,
you can polish your skills in camerawork and equipment use...
You'll actually be able to see the improvement as you progress!
In this section, we'd like to introduce some basic techniques
to help bring more enjoyment to your video recording.
With Betamovie, recording life around you has never been easier!

Contents

Basic camerawork

- 27 Getting stable pictures
- 28 Three frequently used shots
- 30 Sizing the scene
- 30 Scene length

For more effective production

- 31 Lighting
- 32 Sound recording
- 33 Scripts and effects

Adding a professional touch

- 34 Dubbing/Easy editing/Superimposing

Understanding light—for better results

BASIC CAMERA WORK

Getting stable pictures—starts with a correct stance

For hand-held shots, shooting position is the key.

Using these two basic positions as a reference, practice shooting positions until you find the stance which provides the easiest shooting and best results.

Basic shooting positions

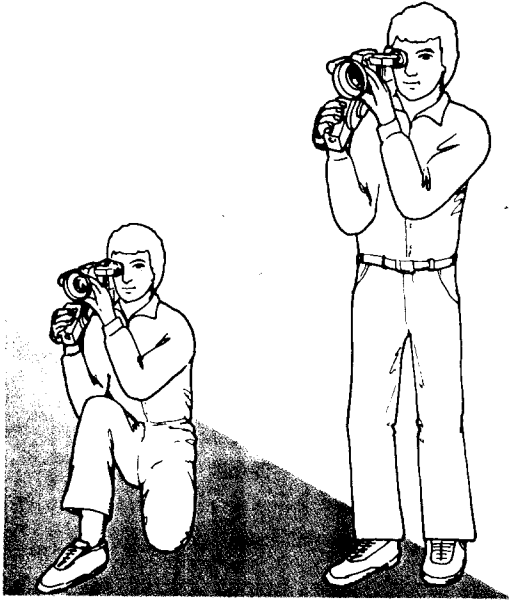

- When kneeling, placing one knee on the ground provides the best stability.

- Place the right eye firmly against the viewfinder eye cup.
- For hand-held shots, put the Betamovie on your shoulder and assume a comfortable, stable position. Make sure the unit does not move.
- Relax your shoulders.
- Put your right elbow firmly against your side to help stabilize the Betamovie.
- If you are going to move the unit while recording, keep both eyes open as much as possible.
- Stand firmly with your feet comfortably apart.

Leaning against something firm such as a wall or tree will also provide extra stability.

Use a tripod or monopod if possible

If you have a tripod for your still camera, it can also be used with Betamovie. Choose a sturdy one.

If a tripod is not available, try placing the camera on a tabletop, wall, or any other flat surface of suitable height.

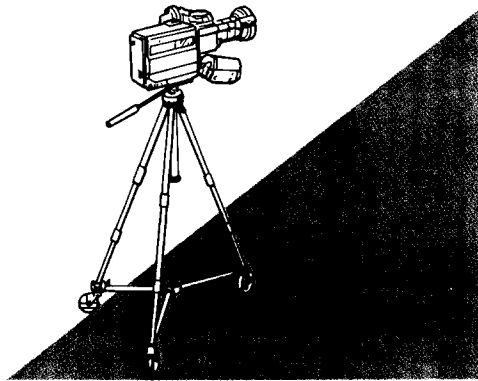

Keeping the horizontal plane level

Even if camera work is smooth and stable, shots can be tilted or off axis horizontally.

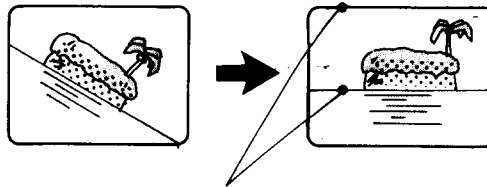

The horizontal plane can be easily determined by using the viewfinder frame as a reference.

Three frequently used shots

These three types of shots will bring additional action and movement to your scenes when properly used.
For greatest effect, it is advisable that they not be overused.

Panning — moving the camera horizontally

For emphasizing the grandeur of a scene, and for including all of the scenery in a single continuous shot.

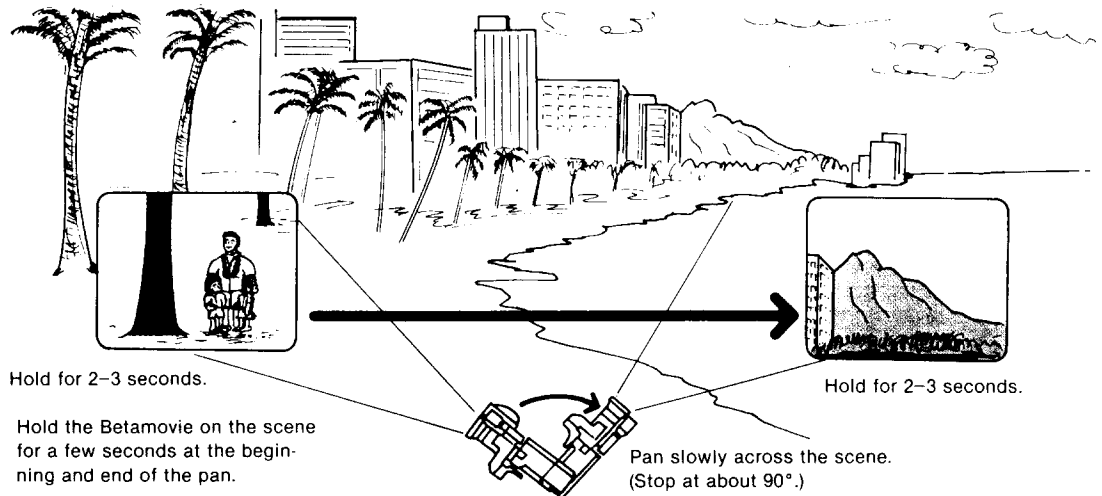

For professional-looking pans

1. First, stand so that you face in the direction where the pan will end.
2. Without moving your feet, rotate your upper body so that your Betamovie faces the direction where the scene will begin.
3. Start shooting. Rotate your body slowly to the point where the pan will stop.

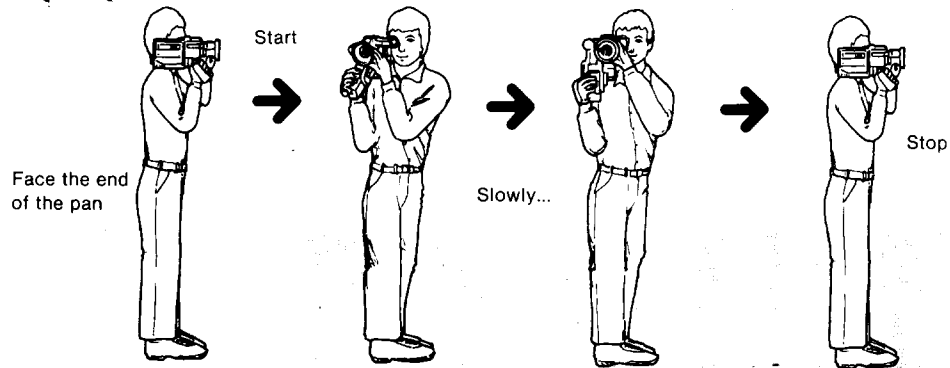

The best panning speed is one that will allow you to explain the scene during playback.

Repeated pans of the same scene should be avoided.

If you can hold your breath during panning and zooming, camera shake can be minimized, and you can concentrate more easily on the scene.

Tilting —moving the camera vertically

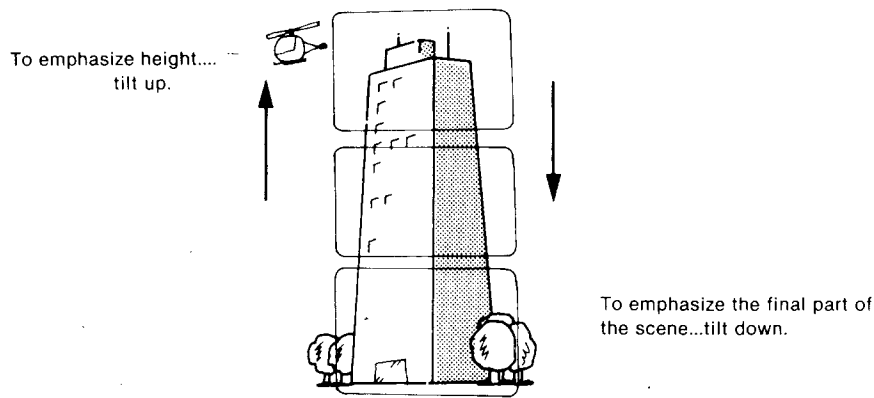

Tilting shots with Betamovie should be slightly faster than pans.

Zooming —changing the size of the subject

To draw attention to something specific...zoom in.

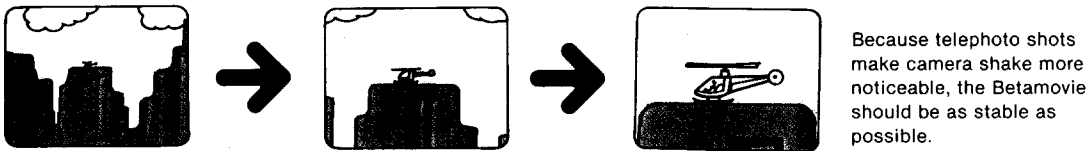

To end the shot by making the circumstances surrounding the scene understood...zoom out.

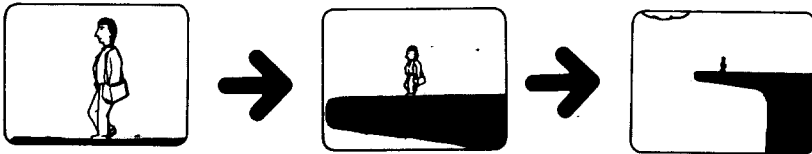

When the power auto zoom is used, zoom speed is constant and smooth for easier viewing. **When the manual zoom lever is used**, zooming speed can be chosen to meet the requirements of the shot. For example, if the lever is turned rapidly, an effective visual “shock” can be obtained. Keep in mind, however, that this can be easily overdone.

Sizing the scene

—mixing long, medium and close-up shots

Continuous use of long shots or close-ups will give your productions a monotonous “flat” impression. To avoid this, it is important to consider exactly what it is that you wish to “say” with every shot. Indeed, it is possible to change the impression that any subject makes merely by changing the way it’s shot.

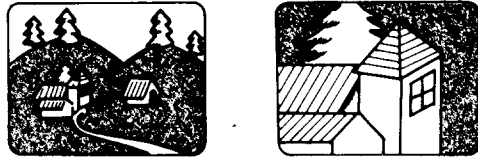

You don’t have to change the subject to alter the scene—you can achieve a different effect by changing the size of the subject itself within the scene.

Framing people

Basic shots for properly framing people are shown below.

Experience has shown that shots that frame people differently than this do not have as pleasant an effect.

Leaving some space above the head makes the scene appear more natural.

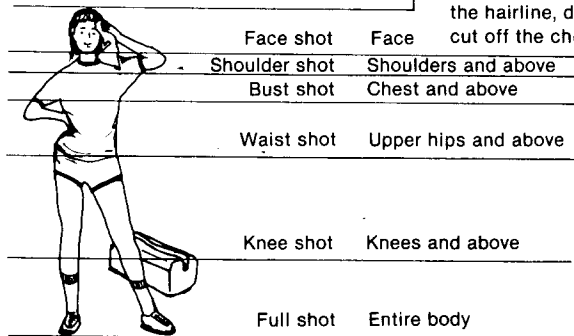

Even if you cut off the hairline, don’t cut off the chin.



Close-up
Emphasize something specific



When shooting a profile, leave space in front of the face to create a “sight line.”

Scene length

—not too long, not too short

While there’s no hard-and-fast rule, it is generally advisable to make each scene 6–7 seconds in length.

A succession of short scenes can tire the viewer, while long, single scenes can become boring.

Cutting according to the narration

Cut the scene when the narration is finished.

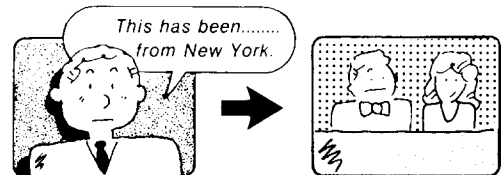

Cutting according to the subject

Make long shots longer...and close-ups shorter.

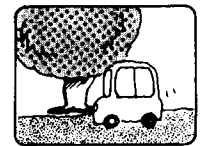
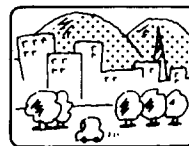

Because long shots have more to see in them than close-ups, show them longer so the viewer may understand what’s there.

Make interesting shots and shots in which the subject is constantly moving longer.

Make static shots shorter

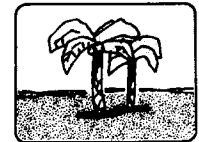

Shoot as if you were watching the playback. That is, it’s helpful to occasionally imagine your commentary of the scene even as you’re shooting it!

FOR MORE EFFECTIVE PRODUCTION

By polishing your skills at video and audio recording, and by shooting original productions based on your own scripts, you'll be able to enjoy video "movies" all the more...

Lighting—For the sharpest pictures, you need the best light

For the most brilliant color in your color scenes, a sufficient light level must be maintained. If shooting is done indoors or under other circumstances where light is insufficient, lights must be used for best results.

What kind of light is best? Choosing the right lights

Photography lamps or halogen lamps are recommended.

For lighting of a wide area for easy use—**reflector flood light**

For special lighting effects—**reflector spotlight**

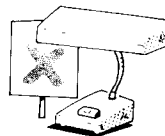

- Because Betamovie uses a Saticon-type tube, fluorescent lights can cause flickering in the scene.
- Don't use a combination of too many different types of lights. Since their color temperatures will vary, the subject's color will not be correct. (For more details, refer to the section entitled "Color temperature" on page 35.)

Lighting the subject

The number of lights and their angle to the subject can make a significant difference in lighting effectiveness.

With a single light:

Locate it above and to one side of the subject. With just one light, contrast is unavoidably enhanced.

To eliminate shadows, another light should be added.

With two lights:

Locate one light above and to one side of the subject, and the second to the side of the subject in such a position that the shadows are illuminated.

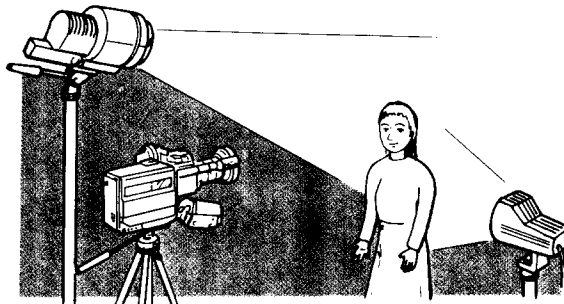

If contrast is too strong when lights are used, point a light at the ceiling or reflect it off a white paper to add soft fill-in light.

Handle lights with care!

- Do not attach lights or floodlights to the accessory shoe as these can cause damage to the body.
- Lights become extremely hot during use—do not touch them!

For instructions on proper use of lights, carefully read the instruction manuals that accompany them.

Sound recording—making sound enhance the scene

Without changing the location, it is possible to get different sound just by changing the type of microphone used.

Should unwanted peripheral noise or operation noise be a cause of concern, use of an external microphone will allow you to record just the sound you want.

The built-in mic is automatically cut off when an external mic is connected to the MIC jack.

For best results when using an external mic, use of the optional SAD-100 external microphone shoe is recommended.

For isolating sounds in the direction the Betamovie is aimed—**uni-directional mic (built-in)**

For recording a narrower field—**supercardioid mic (external)**

For recording field width in accordance with the lens' focal length—**zoom mic (external)**

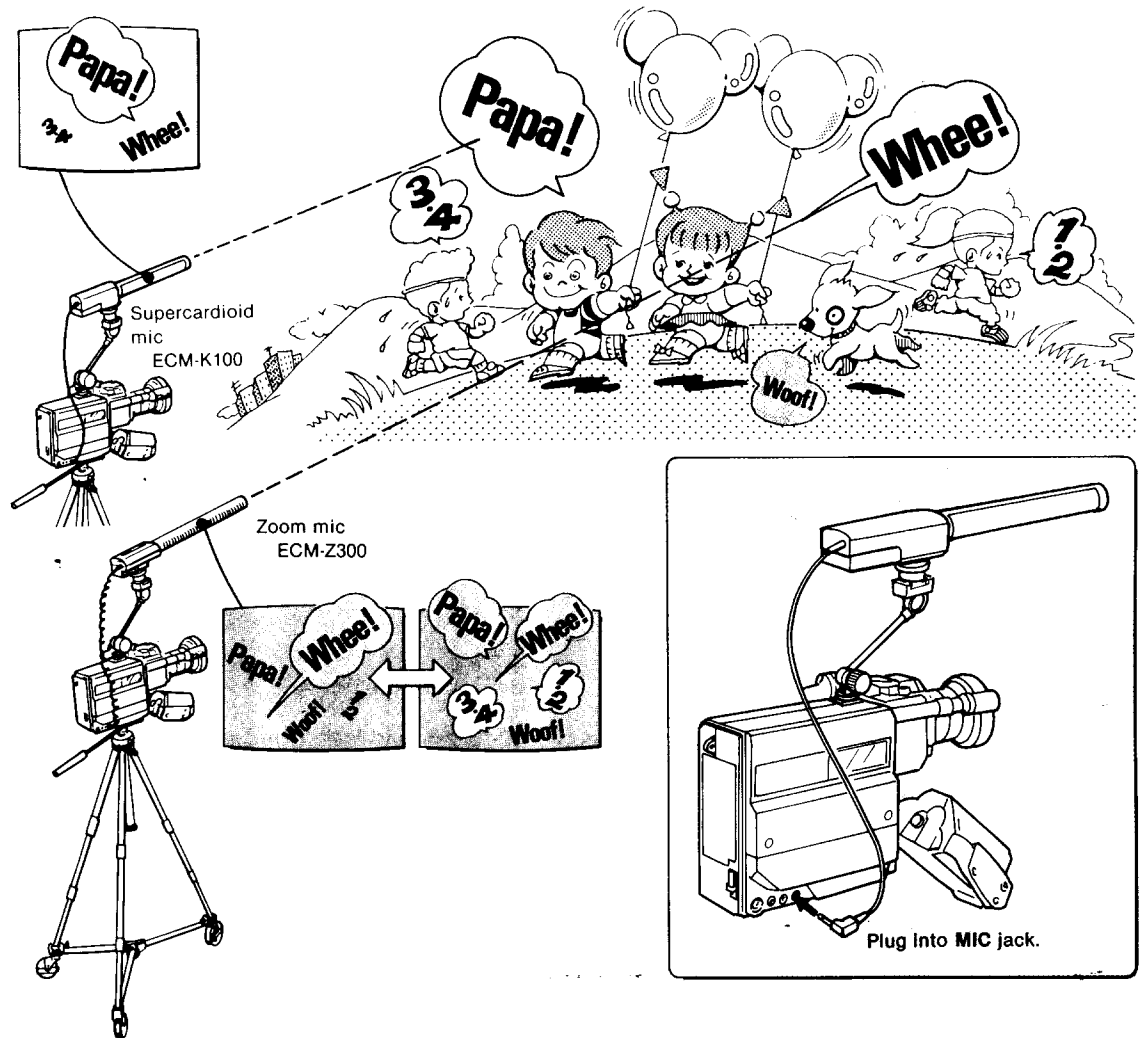

For optimum recording quality, locate the mic as close as possible to the subject.

Scripts and effects—shooting with a plan

To make a first-class production, it is important to decide contents and sequence of shooting in advance.

The first step, then, is to sketch out a simple memo based on the time-tested “five W’s of journalism” (who, what, where, when, why, how).

With this in mind, you can soon be skillfully producing programs of the many exciting events that happen around you, such as sports matches, graduations, birthday parties, weddings, picnics, camping trips, and other special events.

Writing the script

After the theme has been chosen, think about the progression of scenes and jot down a general overall concept on paper. This will be your rough script. As you progress to making a scenario with rough sketches drawn in, each scene will take final shape and the actual shooting should go smoothly. When writing the script, it is helpful to scout the location where shooting will take place, and, in the event of school activities or weddings, to obtain a copy of the program in advance, if possible.

Writing the scenario

| Baseball Tournament page 1... | | Even regular paper can be used |
|-------------------------------|---|--------------------------------|
| 5 sec. Title | Baseball | Write in the narration |
| 10 sec. Zoom out Frame out | Me—“Today’s my day!” | |
| 6 sec. Cut in | Inserting a cut to highlight the season can often be effective | |
| 30 sec. Cut out Panning | Mom—“Here we are at Z Field, where the action is ready to begin.” | |
| 2 min. | 10 sec. | |
| 2 min. 15 sec. Zoom in | Mom—“Come on, Joe!” | |

SE (Sound Effect)—Background music and sound effects

Recording time

Frame out—indicates spot where the scene will change

Camerawork

Draw simple outline sketches in a TV frame

During actual shooting, there are times when following the script exactly is impossible. When this happens, you’ll just have to be flexible and improvise. Take special care when recording sound simultaneously, as it is not unusual for the conversation to drift off course even when the visual side is going according to the script!

Making titles

Inserting a title to introduce your program can do much to enhance interest.

Leave a white “frame” around the visual.



Use high-quality art paper, and draw the visual in water colors, crayon, or other easy-to-use media.

★Paper size should be somewhat larger than the space required for the visual.

Starring...Me
Camera...Pop
Announcer...Mom
Date...Month, Day, Year
Place...Z Field

★Make the title boards called for in the script before shooting.



To record events that occur during shooting, take art paper and some color felt pens, etc., for handy use.

Title boards are art paper on which titles, pictures, etc., are drawn to be shot as part of the program.

Shooting titles—it’s easy!

Have someone hold them...



Lean against or hang from a wall...

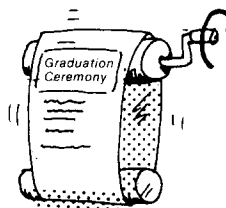

Make a simple reel...

ADDING A PROFESSIONAL TOUCH

Dubbing in the narration or music after shooting:

Dubbing

For dubbing, you need a TV monitor and VCR with an audio dubbing function and a sound source such as a tape recorder or microphone.

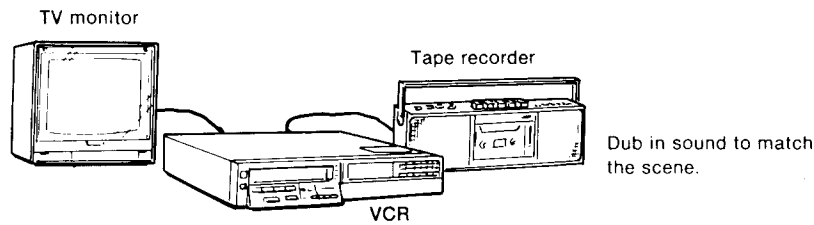

When the overdub is added, the previously recorded sound will be erased.

To edit out unwanted scenes and leave the best cuts in tact:

Easy editing

Two VCRs (one for playback, one for recording) and a TV monitor are required.

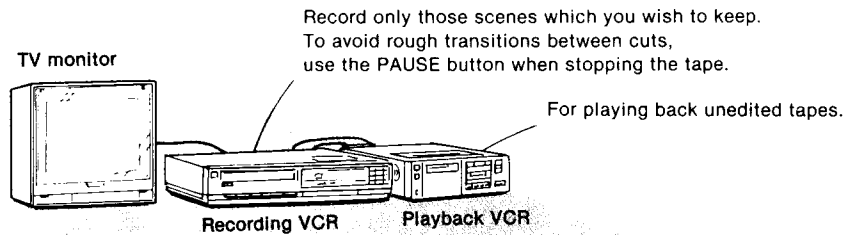

You can also create "theme" tapes by taking appropriate sections from previously recorded tapes.

Avoid repeated editing as picture quality will deteriorate. Each time a tape is copied, some of the original quality is lost.

To add titles or pictures:

Superimposing

A color superimposer, two VCRs (one for playback, one for recording) and a TV monitor are required.

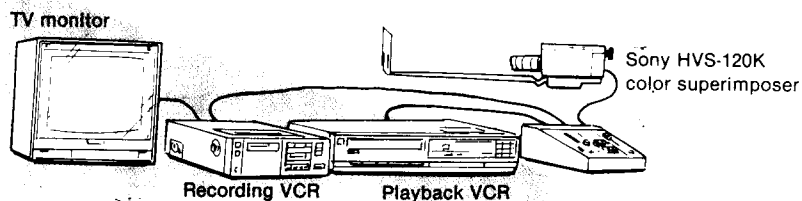

Colors of titles and illustrations can be selected using the superimposer.

UNDERSTANDING LIGHT—FOR BETTER RESULTS

Brightness levels

The single greatest influence on picture quality is the brightness level. Using the following chart as a reference, take a few minutes to familiarize yourself with brightness levels to improve your recording.

When to use an ND filter

Exceptionally bright scenes such as sunny days at the beach in summer or on snow fields in winter will look "washed out" when recorded. To make these scenes recorded naturally, an ND filter is required. (Refer to the chart). Three types are available—ND2, ND4, ND8—which reduce the exposure level to 1/2, 1/4, and 1/8, respectively. Select filters to match the lens diameter of 52 mm.

| ND filter required | Unit: lux | |
|-------------------------|-----------|---|
| | | Snow-covered mountains Snow fields Sandy beach, clear day in summer |
| Normal recording | 100,000 | Clear day, mid-day (100,000) Clear day, mid-afternoon (35,000) Overcast day, mid-day (32,000) |
| | 10,000 | Overcast day, one hour after sunrise (2,000) Office lit by fluorescent lamps, near window (1,000) |
| | 1,000 | Clear day, one hour before sunset (1,000) Department store counter (500~700) Station wicket (650) |
| Video light recommended | 500 | Office lit by fluorescent lamps (400~500) Room lit by two 30 W fluorescent lamps (300) |
| | 100 | Subway station platform (300) Arcade at night (150~200) |
| Video light required | 10 | Theater lobby (15~35) Candle light (10~15) |

Color temperature—how it affects white balance adjustment

If the temperature of an object continues to increase, it will eventually begin giving off light. At this time, there is a fixed relationship between the object's temperature and its "light color." The temperature of the object radiating the light is expressed in absolute temperature (°K). This is also known as the color temperature, which in turn stands for "light color." As color temperature increases, the light color changes from red to yellow to white to blue.

