

# USER MANUAL

# *ProLite*

## LCD Monitor

ENGLISH

DEUTSCH

FRANCAIS

NEDERLANDS

### *ProLite E1908WSV*

Thank you very much for choosing the iiyama LCD monitor.

We recommend that you take a few minutes to read carefully through this brief but comprehensive manual before installing and switching on the monitor. Please keep this manual in a safe place for your future reference.





## Dear user, we congratulate you on the purchase of your iiyama LCD.

All iiyama LCD monitors comply with the ISO13406-2 standard for pixel defects.

For details on warranty and locally used pixel policies that apply directly after installation of your product please check the iiyama website.

In case of a defect, please call your local support hotline.

Country	Phone Number	Country	Phone Number
Austria	+49 1805 44 92 62	Latvia	0 7408838
Belgium	+31 30 240 80 20	Lithuania	0 37 328442; 0 52 2101160
Bulgaria	0 2 9880300	Norway	+45 96 360 374
Czech Republik	220 121 432	Poland	0 801 449262
Denmark	0 96 360 374	Portugal	800 834 196
Estonia	0 6671796	Romania	0 21 210 38 09 33
Finland	0 9 56186130	Russia, Kaliningrad	0 4012631061
France	0 825 828 936	Slovak Republik	0 244 648 151
Germany	0 1805 44 92 62	Spain	902 014 909
Great Britain	0 870 224 95 95	Sweden	0 13 20 14 20
Greece	0 210 289 2000	The Netherlands	0 900-6664867
Hungary	06 1 814 8080; 06 1 340 9951	Ukraine	0 44 458 38 70
Italy	+49 1805 44 92 62		

### Things to check before you call the iiyama information line

- | if the power cable is connected securely and turned on?
- | if the display has been turned on?
- | if the signal cable is connected securely and the correct input selected?
- | if the computer has been restarted with the display connected?
- | if the graphics card is correctly installed with the latest drivers possible?
- | if the correct native resolution has been selected via 'Display Properties'?
- | If the R/G/B signal configuration is correct?
- | if the displays On Screen Menu is shown?
- | if the correct brightness and contrast settings have been set?
- | if given display tolerances and compatibility have been considered?
- | if via the On Screen Menu you have performed a Factory Reset/Recall?

If you have checked all of the above and there is still no picture, call our information line for assistance in your country.

### Before reporting the screen defect, please prepare the following information/evidence:

- | model number \*
- | purchase receipt and serial number \*
- | short description of the defect

### Important Note:

If there is no fault found in the collected equipment after inspection, the transferring party shall incur charges for transport and administration.

\* see the identification plate on the back of the case.

## CE MARKING DECLARATION OF CONFORMITY

This LCD monitor complies with the requirements of the EC Directive 89/336/EEC "EMC Directive" and 73/23/EEC "Low Voltage Directive" as amended by Directive 93/68/EEC.

The electro-magnetic susceptibility has been chosen at a level that gives correct operation in residential areas, business and light industrial premises and small-scale enterprises, inside as well as outside of the buildings. All places of operation are characterised by their connection to the public low voltage power supply system.

- 
- We reserve the right to change specifications without notice.
  - All trademarks used in this user manual are the property of their respective owners.
  - As an ENERGY STAR® Partner, iiyama has determined that this product meets the ENERGY STAR® guidelines for energy efficiency.

# TABLE OF CONTENTS

FOR YOUR SAFETY .....	1
SAFETY PRECAUTIONS .....	1
SPECIAL NOTES ON LCD MONITORS .....	3
CUSTOMER SERVICE .....	3
CLEANING .....	3
BEFORE YOU OPERATE THE MONITOR .....	4
FEATURES .....	4
CHECKING THE CONTENTS OF THE PACKAGE .....	4
FITTING AND REMOVAL OF BASE .....	5
CONTROLS AND CONNECTORS .....	6
CONNECTING YOUR MONITOR .....	7
COMPUTER SETTING .....	8
ADJUSTING THE VIEWING ANGLE .....	8
OPERATING THE MONITOR .....	9
ADJUSTMENT MENU CONTENTS .....	10
SCREEN ADJUSTMENTS .....	16
POWER MANAGEMENT FEATURE .....	19
TROUBLE SHOOTING .....	20
APPENDIX .....	22
SPECIFICATIONS .....	22
DIMENSIONS .....	23
COMPLIANT TIMING .....	23



LAMP(S) INSIDE THIS PRODUCT CONTAIN MERCURY AND MUST BE RECYCLED OR DISPOSED OF ACCORDING TO LOCAL, STATE OR FEDERAL LAWS.

For disposal or recycling information, please contact your local authorities or the Electronic Industries Alliance ([www.eiae.org](http://www.eiae.org)).

This information is only for U.S.A..



We recommend recycling of used product. Please contact your dealer or iiyama service center. Recycle information is obtained via the Internet, using the address: <http://www.iiyama.com>

You can access the Web page of different countries from there.

# FOR YOUR SAFETY

## SAFETY PRECAUTIONS

### WARNING

#### **STOP OPERATING THE MONITOR WHEN YOU SENSE TROUBLE**

If you notice any abnormal phenomena such as smoke, strange sounds or fumes, unplug the monitor and contact your dealer or iiyama service center immediately. Further use may be dangerous and can cause fire or electric shock.

#### **NEVER REMOVE THE CABINET**

High voltage circuits are inside the monitor. Removing the cabinet may expose you to the danger of fire or electric shock.

#### **DO NOT PUT ANY OBJECT INTO THE MONITOR**

Do not put any solid objects or liquids such as water into the monitor. In case of an accident, unplug your monitor immediately and contact your dealer or iiyama service center. Using the monitor with any object inside may cause fire, electric shock or damage.

#### **INSTALL THE MONITOR ON A FLAT, STABLE SURFACE**

The monitor may cause an injury if it falls or is dropped.

#### **DO NOT USE THE MONITOR NEAR WATER**

Do not use where water may be splashed or spilt onto the monitor as it may cause fire or electric shock.

#### **OPERATE UNDER THE SPECIFIED POWER SUPPLY**

Be sure to operate the monitor only with the specified power supply. Use of an incorrect voltage will cause malfunction and may cause fire or electric shock.

#### **PROTECT THE CABLES**

Do not pull or bend the power cable and signal cable. Do not place the monitor or any other heavy objects on the cables. If damaged, the cables may cause fire or electric shock.

#### **ADVERSE WEATHER CONDITIONS**

It is advisable not to operate the monitor during a heavy thunder storm as the continual breaks in power may cause malfunction. It is also advised not to touch the plug in these circumstances as it may cause electric shock.

## CAUTION

### INSTALLATION LOCATION

Do not install the monitor where sudden temperature changes may occur, or in humid, dusty or smoky areas as it may cause fire, electric shock or damage. You should also avoid areas where the sun shines directly on the monitor.

### DO NOT PLACE THE MONITOR IN A HAZARDOUS POSITION

The monitor may topple and cause injury if not suitably located. Please also ensure that you do not place any heavy objects on the monitor, and that all cables are routed such that children may not pull the cables and possibly cause injury.

### MAINTAIN GOOD VENTILATION

Ventilation slots are provided to keep the monitor from overheating. Covering the slots may cause fire. To allow adequate air circulation, place the monitor at least 10 cm (or 4 inches) from any walls. Do not remove the tilt stand when operating the monitor. Ventilation slots on the back of the cabinet will be blocked and the monitor may overheat if the stand is removed. This may cause fire or damage. Operating the monitor on its back, side, upside down or on a carpet or any other soft material may also cause damage.

### DISCONNECT THE CABLES WHEN YOU MOVE THE MONITOR

When you move the monitor, turn off the power switch, unplug the monitor and be sure the signal cable is disconnected. If you do not disconnect them, it may cause fire or electric shock.

### UNPLUG THE MONITOR

If the monitor is not in use for a long period of time it is recommended that it is left unplugged to avoid accidents.

### HOLD THE PLUG WHEN DISCONNECTING

To disconnect the power cable or signal cable, always pull it by the plug. Never pull on the cable itself as this may cause fire or electric shock.

### DO NOT TOUCH THE PLUG WITH WET HANDS

Pulling or inserting the plug with wet hands may cause electric shock.

### WHEN YOU INSTALL THE MONITOR ON YOUR COMPUTER

Be sure the computer is strong enough to hold the weight of the monitor, otherwise, you may damage your computer.

### DO NOT PUT FLOPPY DISKS NEAR THE SPEAKERS

Magnetically recorded data, such as on a floppy disk, may become corrupted by the magnetic field produced by the speakers if the disks are placed on or near the speakers.

## OTHERS

### ERGONOMIC RECOMMENDATIONS

To eliminate eye fatigue, do not operate the monitor against a bright background or in a dark room. For optimal viewing comfort, the monitor should be just below eye level and 40-60 cm (16-24 inches) away from your eyes. When using the monitor over a prolonged time, a ten minute break every hour is recommended as looking at the screen continuously can cause eye strain.

## SPECIAL NOTES ON LCD MONITORS

The following symptoms are normal with LCD monitors and do not indicate a problem.

### NOTE

- When you first turn on the LCD monitor, the picture may not fit in the display area because of the type of computer that is used. In this case, adjust the picture position to the correct position.
- Due to the nature of the backlight, the screen may flicker during initial use. Turn off the Power Switch and then turn it on again to make sure the flicker disappears.
- You may find slightly uneven brightness on the screen depending on the desktop pattern you use.
- Due to the nature of the LCD screen, an afterimage of the previous screen may remain after switching the image, when the same image is displayed for hours. In this case, the screen is recovered slowly by changing the image or turning off the Power Switch for hours.
- Contact your dealer or iiyama service center for the backlight replacement when the screen is dark, flickering or not lighting up. Never attempt to replace it by yourself.

## CUSTOMER SERVICE

### NOTE

- The fluorescent light used in the LCD monitor may have to be periodically replaced. For the warranty coverage on this component, please check with local iiyama service center.
- If you have to return your unit for service and the original packaging has been discarded, please contact your dealer or iiyama service center for advice or replacement packaging.

## CLEANING

### WARNING

- If you drop any materials or liquids such as water into the monitor when cleaning, unplug the power cable immediately and contact your dealer or iiyama service center.

### CAUTION

- For safety reasons, turn off the power switch and unplug the monitor before you clean it.

### NOTE

- To protect the LCD panel, do not scratch or rub the screen with a hard object.
- Never use any of the following strong solvents. These will damage the cabinet and the LCD screen.
 

Thinner	Spray-type cleaner
Benzine	Wax
Abrasive cleaner	Acid or Alkaline solvent
- Touching the cabinet with any product made from rubber or plastic for a long time may cause degeneration or loss of paint on the cabinet.

### CABINET

Stains can be removed with a cloth lightly moistened with a mild detergent solvent. Then wipe the cabinet with a soft dry cloth.

### LCD

Periodic cleaning with a soft dry cloth is recommended.

### SCREEN

Don't use tissue paper etc. because these will damage the LCD screen.

# BEFORE YOU OPERATE THE MONITOR

## FEATURES

- ◆ 48cm (19") TFT Color LCD Monitor
- ◆ Supports Resolutions up to 1680 × 1050
- ◆ High Contrast 1000:1(static), DCR function available / High Brightness 300cd/m<sup>2</sup>
- ◆ Multi-Color Control  
Supports sRGB International Standard
- ◆ Gamma Control  
Clear Display for Moving Pictures & Photographs
- ◆ Digital Character Smoothing
- ◆ Automatic Set-up
- ◆ Stereo Speakers  
2 × 1W Stereo Speakers
- ◆ Economy Mode  
Reduced Power Consumption
- ◆ Plug & Play VESA DDC2B Compliant  
Windows® 95/98/2000/Me/XP/Vista Compliant
- ◆ Power Management (ENERGY STAR® and VESA DPMS Compliant)
- ◆ VESA Mounting Standard (100mm×100mm) Compliant

## CHECKING THE CONTENTS OF THE PACKAGE

The following accessories are included in your package. Check to see if they are enclosed with the monitor. If anything is missing or damaged, please contact your local iiyama dealer or regional iiyama office.

- |                |                          |
|----------------|--------------------------|
| ■ Power Cable* | ■ D-Sub Signal Cable     |
| ■ Audio Cable  | ■ Stand (Stand-Arm,Base) |
| ■ User Manual  |                          |

### CAUTION

\* The rating of the Power Cable enclosed in 120V area is 10A/125V. If you are using a power supply higher than this rating, then a power cable with a rating of 10A/250V must be used.

However, all guarantees and warranties are void for any problems or damage caused by a power cable not supplied by iiyama.



## FITTING AND REMOVAL OF BASE

### CAUTION

- Install the stand on a stable surface. The monitor may cause injury or damage if it falls or is dropped.
- Do not give a strong impact to the monitor. It may cause damage.
- Unplug the monitor before installation to avoid electric shock or damage.

### <Install>

1. Put a piece of soft cloth on the table beforehand to prevent the monitor from being scratched. Lay the monitor flat on a table with front face down.
2. Hold the monitor and push the Stand-Arm.
3. Hold the monitor and push the Stand-Base.

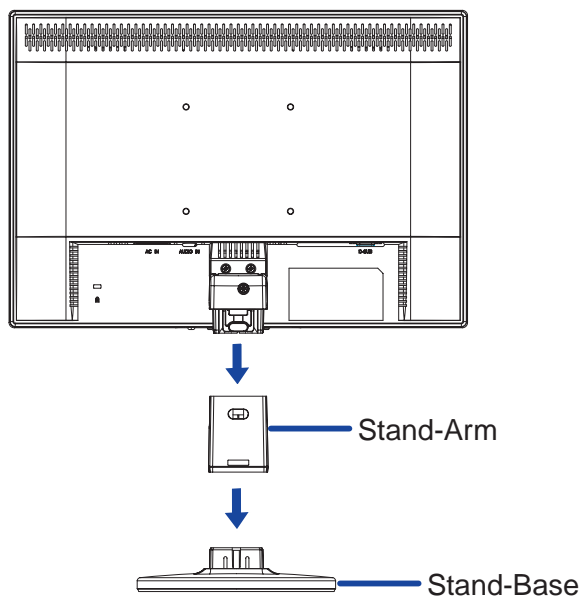

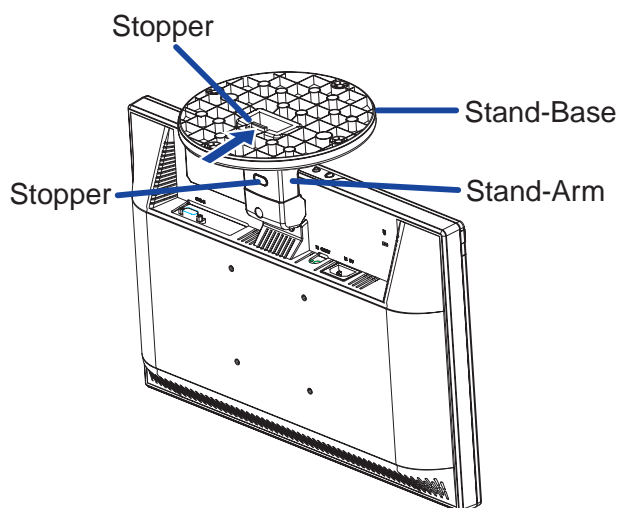

### <Remove>

1. Put a piece of soft cloth on the table beforehand to prevent the monitor from being scratched. Lay the monitor flat on a table with front face down.
2. Press the stopper at the bottom of the stand and remove the Stand-Base from the arm.
3. Press the stopper at the back of the stand arm and remove the Stand-Arm from the monitor.

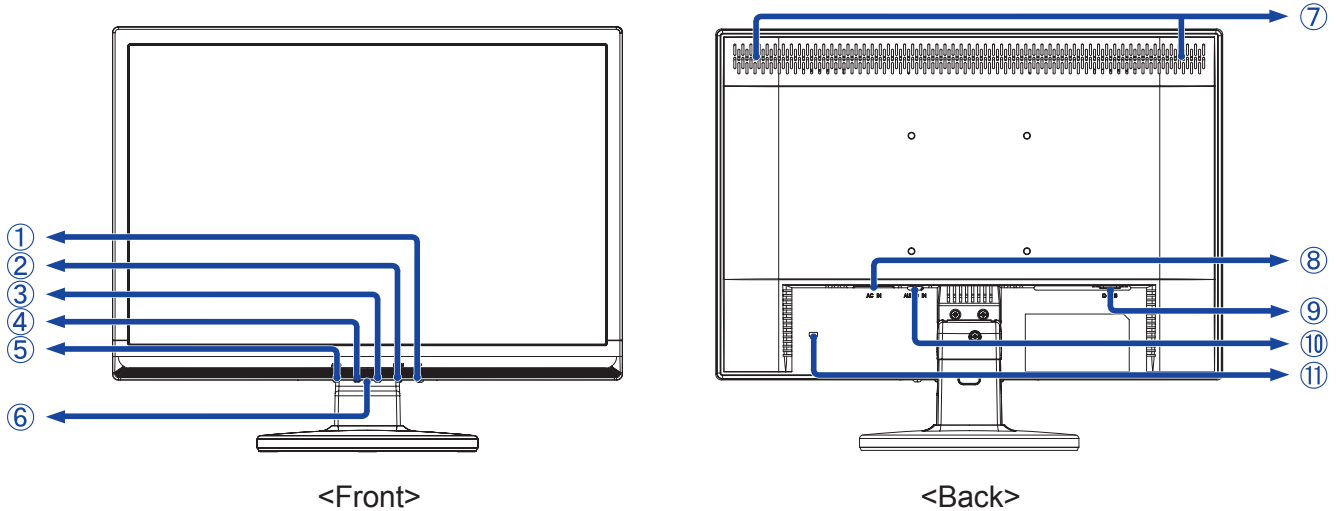

## CONTROLS AND CONNECTORS



- ① Power Switch (  )
- ② Menu Button (MENU)
- ③ + Button ( + )
- ④ – Button ( – )
- ⑤ Auto Button (AUTO)
- ⑥ Power Indicator

**NOTE** Blue: Normal operation  
Orange: Power Management

The monitor enters into power management mode which reduces the power consumption to less than 2W when receiving no horizontal and/or vertical sync signal.

- ⑦ Speakers
- ⑧ AC Connector (AC IN)
- ⑨ D-sub mini 15pin Connector (D-SUB)
- ⑩ Audio Connector (AUDIO IN)
- ⑪ Keyhole for Security Lock

**NOTE** You can fasten a security lock and cable to prevent the monitor from being removed without your permission.

## CONNECTING YOUR MONITOR

- ① Ensure that both the computer and the monitor are switched off.
- ② Connect the computer to the monitor with the signal cable.
- ③ Connect the monitor to the audio equipment with the Audio Cable when using the audio features.
- ④ Connect the Power Cable to the monitor first and then to the power supply.

- NOTE**
- The signal cables used for connecting the computer and monitor may vary with the type of computer used. An incorrect connection may cause serious damage to both the monitor and the computer. The cable supplied with the monitor is for a standard 15 pin D-Sub connector. If a special cable is required please contact your local iiyama dealer or regional iiyama office.
  - For connection to Macintosh computers, contact your local iiyama dealer or regional iiyama office for a suitable adaptor.
  - Make sure you tighten the finger screws at each end of the signal cable.

[Example of Connection]

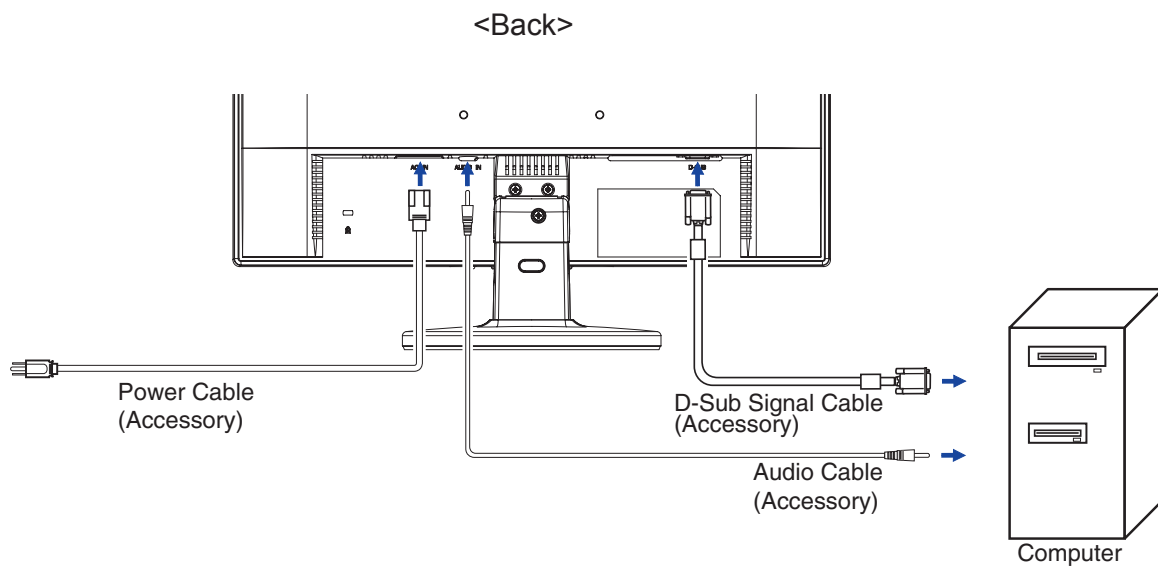

## COMPUTER SETTING

### ■ Signal Timing

Change to the desired signal timing listed on page 23: COMPLIANT TIMING.

### ■ Windows 95/98/2000/Me/XP/Vista Plug & Play

The iiyama LCD monitor complies with DDC2B of VESA standard. The Plug & Play function runs on Windows 95/98/2000/Me/XP/Vista by connecting the monitor to DDC2B compliant computer with the Signal Cable supplied. Windows 95/98/2000/Me/XP/Vista Monitor Information File for iiyama monitors may be necessary for your computer and obtained via the Internet, using the address:  
<http://www.iiyama.com>

### NOTE

- For additional information on how to download the driver for your monitor, please access one of the internet sites noted above.
- Monitor Drivers are not required in most cases for Macintosh or Unix operating systems. For further information, please contact your computer dealer first for advice.

## ADJUSTING THE VIEWING ANGLE

- For optimal viewing it is recommended to look at the full face of the monitor.
- Hold the stand so that the monitor does not topple when you change the monitor's angle.
- You are able to adjust the monitor's angle up to 20 degrees upward, 5 degrees downward.
- In order to ensure a healthy and relaxed body position when using the monitor at visual display workstations, it is recommended that the adjusted tilt angle should not exceed 10 degrees. Adjust the monitor's angle to your own preference.

### NOTE

- Do not touch the LCD screen when you change the angle. It may cause damage or break the LCD screen.
- Careful attention is required not to catch your fingers or hands when you change the angle.

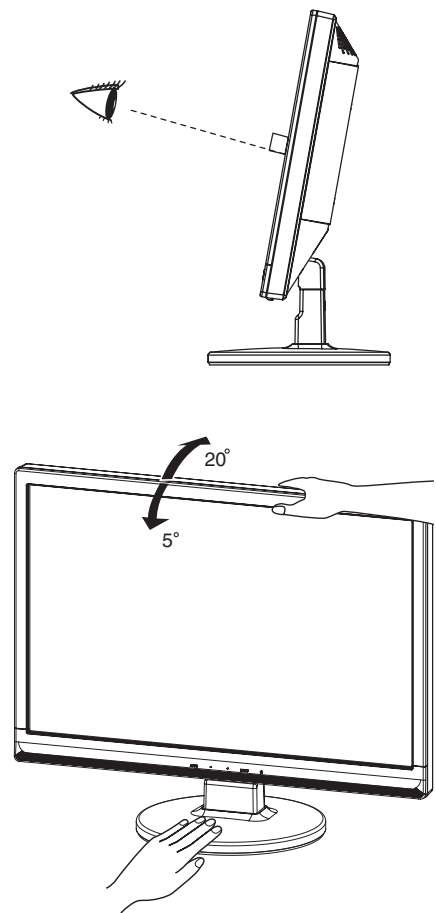

# OPERATING THE MONITOR

To create the best picture, your iiyama LCD monitor has been preset at the factory with the COMPLIANT TIMING shown on page 23. You are also able to adjust the picture by following the button operation shown below. For more detailed adjustments, see page 16 for SCREEN ADJUSTMENTS.

- 1 Press the Menu Button to start the On Screen Display feature. There are additional Menu pages which can be switched by using the +/- Buttons.

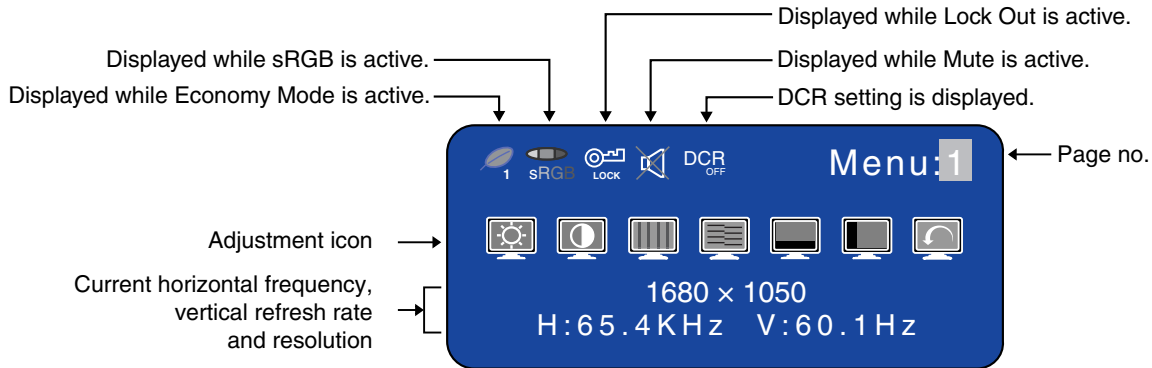

- 2 Select the Menu page which contains the adjustment icon relating to the adjustment you want to make. Press the Menu Button again. Then, use the +/- Buttons to highlight the desired adjustment icon. Press the Menu Button again.

- 3 Use the +/- Buttons to make the appropriate adjustment or setting.

For example, to correct for vertical position, select Menu page number 1 and then press the Menu Button. Then, select  (V-Position) by using the +/- Buttons.

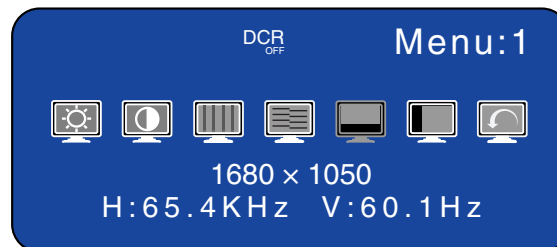

An adjustment scale appears after you press the Menu Button. Use the +/- Buttons to change the vertical position settings. The vertical position of the overall display should be changing accordingly while you are doing this.

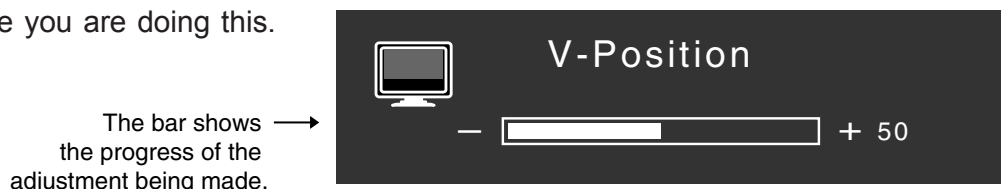

## NOTE

- When button operations are aborted during adjustment, On-Screen Display disappears when the time set for the OSD Off Timer has passed. The Auto Button can be used to exit OSD window immediately.
- Any changes are automatically saved in the memory when the On Screen Display disappears. Turning off the power should be avoided while using the Menu.
- Adjustments for Clock, Phase and Position are saved for each signal timing. Except for these adjustments, all other adjustments have only one setting which applies to all signal timings.

## ADJUSTMENT MENU CONTENTS

### Direct

You can skip the Menu pages and display an adjustment scale directly by using the following button operations.

- Brightness / Contrast / Economy Mode / Picture Mode / Volume / DCR:

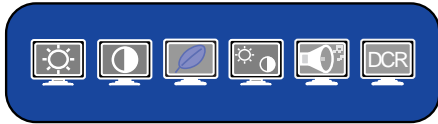

To display direct menu press either of the +/- Buttons. Continue to use the +/- Buttons to select the adjustments required.









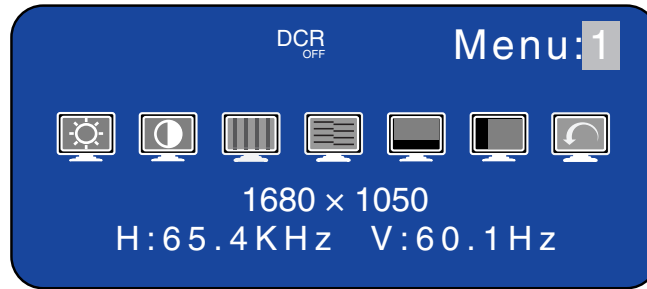













- Auto Set-up: Press the Auto Button when the Menu is not displayed.
- Volume (Mute): With the OSD menu off, the pressing and holding of the Menu Button for 1-2 seconds will enable/disable the Audio Mute facility.
- Lock Out: With the OSD menu off, pressing and holding the Menu and '-' Buttons simultaneously for a period of at least 7 seconds will enable and disable the OSD Lock Out mode.

 is displayed while Lock Out is active.

LOCK

## Menu : 1



Adjustment Item	Problem / Option	Button to Press
 Brightness *1 <b>Direct</b>	Too dark Too bright	 <b>+</b>  <b>-</b>
 Contrast <b>Direct</b>	Too dull Too intense	 <b>+</b>  <b>-</b>
 Clock *2	To correct flickering text or lines	 <b>+</b>  <b>-</b>
 Phase *2	To correct flickering text or lines	 <b>+</b>  <b>-</b>
 V-Position	 Too low  Too high	 <b>+</b>  <b>-</b>
 H-Position	 Too far to the left  Too far to the right	 <b>+</b>  <b>-</b>
 Return to Menu	Highlight "Menu : 1" again.	

\*1 Adjust the Brightness when you are using the monitor in a dark room and feel the screen is too bright.

\*2 See page 16 for SCREEN ADJUSTMENTS.

**Direct** See page 10 for Direct adjustment.



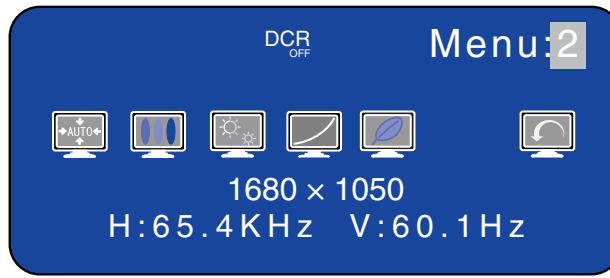



Menu : 2



Adjustment Item	Problem / Option		Button to Press	
 Auto Set-up <sup>*3</sup> <b>Direct</b>	NO	Return to Menu.		
	YES	Adjust Clock, Phase, V-Position and H-Position automatically.		
	Setting	Off	The Auto Set-up is not performed when the signal input is changed.	
		On	Adjust Clock, Phase, V-Position and H-Position automatically when the signal input is changed.	

**NOTE**

- The brightness of screen varies for several seconds during the adjustment.
- This function is not performed automatically when changing the signal input because the factory-preset of "Setting" in Auto Set-up is set to Off.

 Color Temp.	1	Color 1: 9300K		
	2	Color 2: 7500K		
	3	Color 3: 6500K		
	s	sRGB		
	 (User)		R(Red)	Too weak   Too strong  
			G(Green)	
B(Blue)				
Y(Yellow)				
C(Cyan)				
M(Magenta)				









**NOTE**

- sRGB is an international standard which defines and unifies the difference of color appearance between equipment.
- You can not adjust the Brightness, Contrast, Gamma and Economy Mode during sRGB mode because those settings are locked.
-  is displayed while sRGB is active.

<sup>\*3</sup> For best results, use the Auto Set-up in conjunction with the adjustment pattern. See page 16 for SCREENADJUSTMENTS.

**Direct** See page 10 for Direct adjustment.



Menu : 2	
Adjustment Item	Problem / Option
 Sharpness	1 2 3 4 5     <p>Adjust the picture quality at resolutions of less than 1680 × 1050. You can change the picture quality from 1 to 5 (sharp to soft). Press the + Button to change the picture quality in numerical order. Press the – Button to change the picture quality in reverse numerical order.</p>
 Gamma	Off      Normal
	Mode1      High contrast
	Mode2      Dark
 Economy Mode	Off      Normal
	Mode1      Brightness of back-light is reduced.
	Mode2      Brightness of back-light is reduced more than Mode1.
<b>NOTE</b> ■  is displayed while Economy Mode is active.	
 Return to Menu	Highlight “Menu : 2” again.

Menu : 3

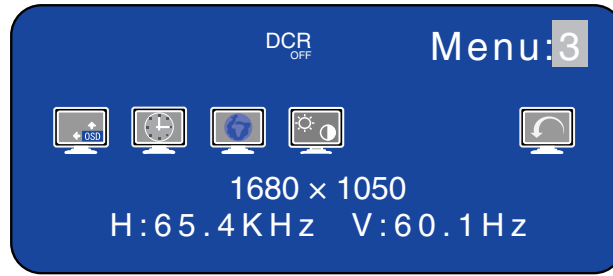

Adjustment Item	Problem / Option		Button to Press	
OSD Position	1 2 3 4 5 You can move the OSD display area to any one of the following 5 positions within the overall display: Press the + Button to move the OSD in numerical order. Press the – Button to move the OSD in reverse numerical order.		+ –	
OSD Off Timer	Set the OSD Off Timer for 3-60 seconds.		+ –	
Language	English	English	Español	Spanish
	Deutsch	German	Italiano	Italian
	Français	French	日本語	Japanese
Picture Mode	STD	For general windows environment and monitor default setting.		
	MOVIE	For movie and video environment.		
	OFFICE	For text editing and viewing in a word processing environment.		
	SCENERY	For displaying outdoor scenery images.		
	GAME	For PC game environment.		
<b>NOTE</b> You can not adjust the Brightness, Contrast, Color Temp., Gamma, Economy Mode and DCR during Picture Mode because those settings are locked.				
Return to Menu	Highlight “Menu : 3” again.			

**Menu : 4**

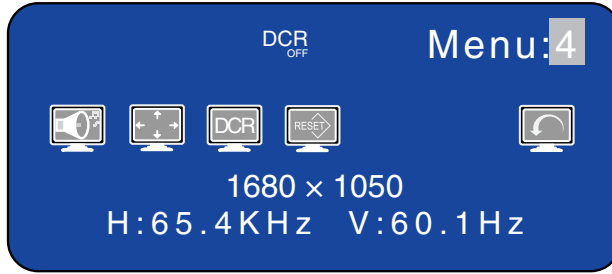

Adjustment Item	Problem / Option	Button to Press
Volume <b>Direct</b>	Too soft Too loud	+ -
<b>NOTE</b> ■  is displayed while Mute is active.		
Full Screen	Full	Stretch the picture to fit the full screen.
	Aspect	Stretch the picture and keep the screen size ratio.
<b>NOTE</b> Adjusts screen size unless input timing is 16:10 in aspect ratio.		
DCR <b>Direct</b>	Off	Typical Contrast Ratio
	On	Increased Contrast Ratio
<b>NOTE</b> DCR adjusts brightness according to the image, and improve the contrast ratio during move playing. Brightness, sRGB and Economy Mode cannot be adjusted and selected while DCR is active.		
Reset	NO	Return to Menu.
	YES	Factory-preset data is restored.
Return to Menu	Highlight "Menu : 4" again.	

**Direct** See page 10 for Direct adjustment.

## SCREEN ADJUSTMENTS

- The screen adjustments described in this manual are designed to set image position and minimize flicker or blur for the particular computer in use.
- The monitor is designed to provide the best performance at resolution of 1680 × 1050, but can not provide the best at resolutions of less than 1680 × 1050 because the picture is automatically stretched to fit the full screen. It is recommended to operate at resolution of 1680 × 1050 in normal use.
- Displayed text or lines will be blurred or irregular in thickness when the picture is stretched due to the screen enlargement process.
- It is preferable to adjust the image position and frequency with the monitor controls, rather than the computer software or utilities.
- Perform adjustments after a warm-up period of at least thirty minutes.
- Additional adjustments may be required after the Auto Set-up depending on the resolution or signal timing.
- The Auto Set-up may not work correctly when displaying the picture other than the screen adjustment pattern. In this case, manual adjustments are required.

There are two ways to adjust the screen. One way is automatic adjustment for Clock, Phase and Position. The other way is performing each adjustment manually.

Perform the Auto Set-up first when the monitor is connected to a new computer, or resolution is changed. If the screen has a flicker or blur, or the picture does not fit in the display area after performing the Auto Set-up, manual adjustments are required. Both adjustments should be made by using the screen adjustment pattern (Test.bmp) obtained via the Iiyama web site (<http://www.iiyama.com>).

Adjust the image by following the procedure below to get the desired picture.

This manual explains adjustment under Windows 95/98/2000/Me/XP/Vista.

- ① **Display the picture at the optimum resolution.**
- ② **Enter the Test.bmp (screen adjustment pattern) to wallpaper.**

### NOTE

- Consult the appropriate documentation for doing this.
- Test.bmp is made at resolution of 1280 × 1024. Set the display position to center in the wallpaper setting dialogue box. If you use Microsoft® PLUS! 95/98 cancel the setting of “Stretch desktop wallpaper to fit the screen”.

[Adjustment pattern]

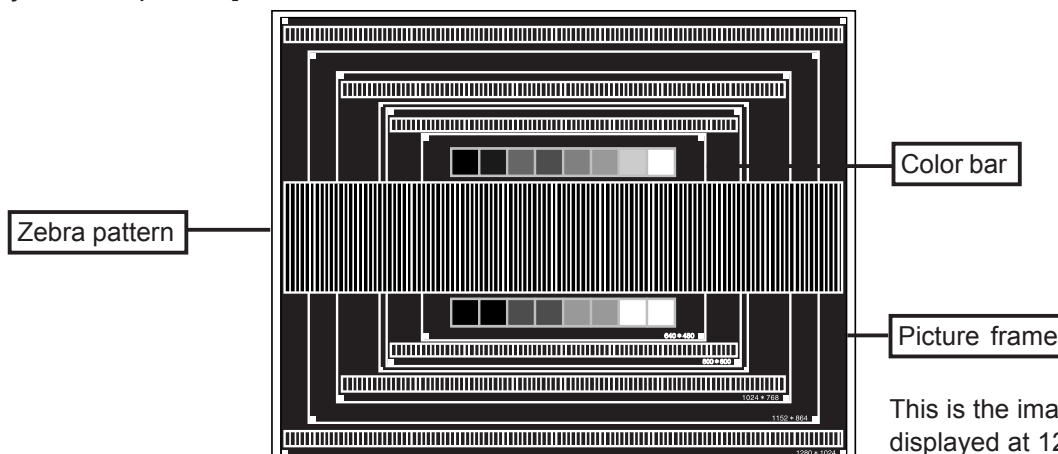

This is the image displayed at 1280 × 1024.

- ③ Press the Auto Button. (Auto Set-up)
- ④ Adjust the image manually by following procedure below when the screen has a flicker or blur, or the picture does not fit in the display area after performing the Auto Set-up.
- ⑤ Adjust the V-Position so that the top and bottom of the picture frame will fit to the display area.

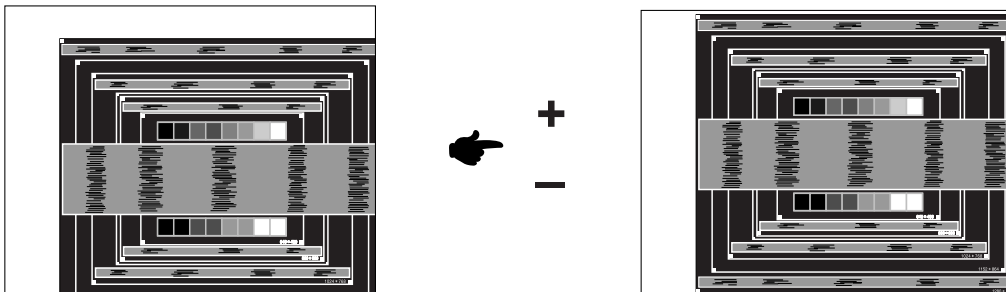

- ⑥ 1) Adjust the H-Position so that the left side of the picture frame will move to the left edge of the display area.

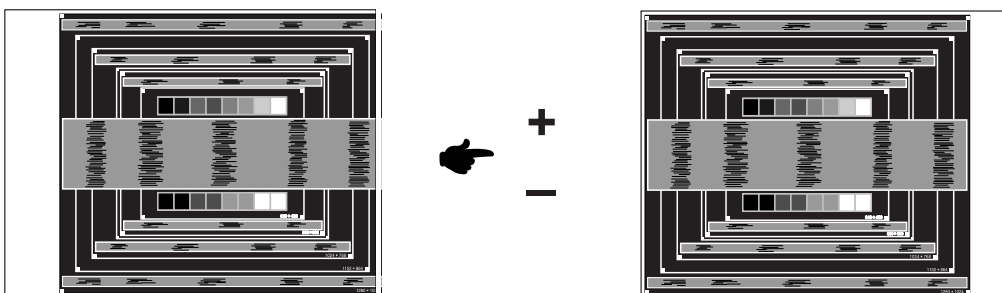

- 2) Stretch the right side of the picture frame to the right edge of the display area by adjusting the Clock.

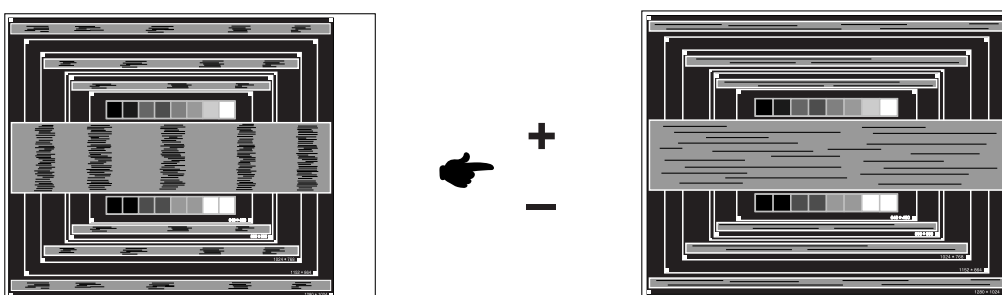
**NOTE**

- When the left side of the picture frame moves apart from the left edge of the display area during the Clock adjustment, adjust steps 1) and 2).
- Another way to make the Clock adjustment is to correct the vertical wavy lines in the zebra pattern.
- The picture may flicker during the Clock, H-Position and V-Position adjustment.
- In case the picture frame is bigger or smaller than the data display area after the Clock adjustment, repeat steps from ③.

- ⑦ Adjust the Phase to correct horizontal wavy noise, flicker or blur in the zebra pattern.

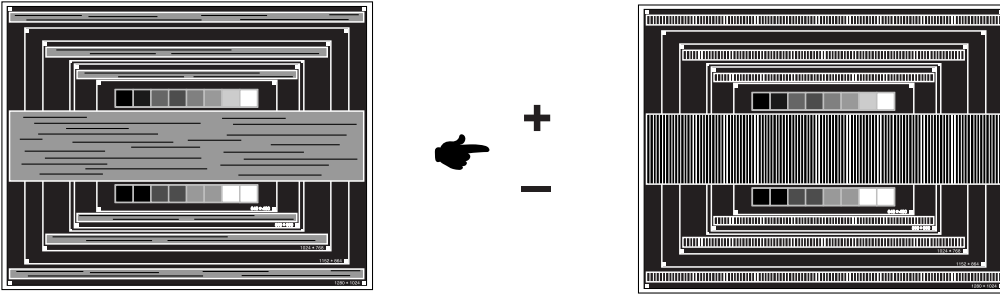
**NOTE**

- In case the strong flicker or blurs remain on a part of the screen, repeat steps ⑥ and ⑦ because the Clock may not be adjusted correctly. If the flicker or blurs still remain, set the refresh rate of computer to low (60Hz) and repeat steps from ③ again.
- Adjust the H-Position after the Phase adjustment if the horizontal position moves during the adjustment.

- ⑧ Adjust the Brightness and Color Temp. to get the desired picture after you complete the Clock and Phase adjustments.  
Put back your favorite wallpaper.

## POWER MANAGEMENT FEATURE

The power management feature of this product complies with power saving requirement of ENERGY STAR® and VESA DPMS. When activated, it automatically reduces unnecessary power consumption of the monitor when your computer is not in use.

To use the feature, the monitor needs to be connected to a VESA DPMS compliant computer. There is a power management step the monitor takes as described below. The power management function, including any timer settings is configured by the operating system. Check your operating system manual for information on how this can be configured.

### ■ Power Management Mode

When the H-sync signal / V-sync signal / H and V sync signals from the computer are off, the monitor enters into Power Management Mode which reduces the power consumption to less than 2W. The screen becomes dark, and the power indicator turns to orange. From Power Management Mode, the image reappears in several seconds when either the keyboard or the mouse are touched again.

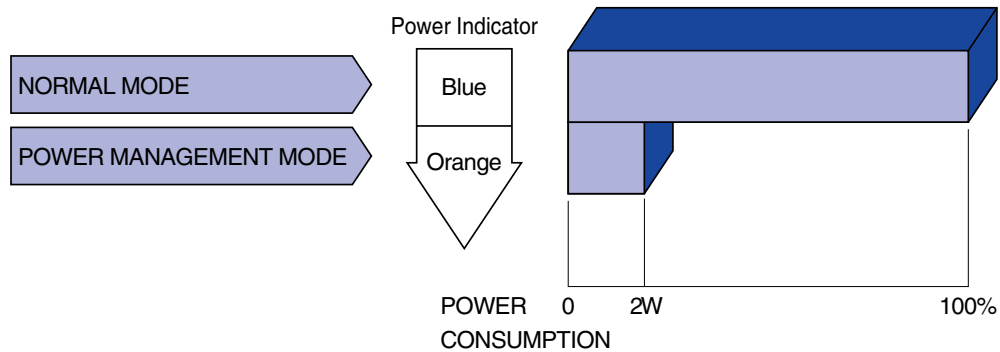

### NOTE

- Even when using the power management mode, the monitor consumes electricity. Turn off the Power Switch whenever the monitor is not in use, during the night and weekends, to avoid unnecessary power consumption.
- It is possible that the video signal from the computer may be on while the H or V sync signal is missing. In this instance, the POWER MANAGEMENT feature may not work properly.

# TROUBLE SHOOTING

If the monitor fails to operate correctly, please follow the steps below for a possible solution.

1. Perform the adjustments described in OPERATING THE MONITOR, depending on the problem you have. If the monitor does not get a picture, skip to 2.
2. Consult the following items if you cannot find an appropriate adjustment item in OPERATING THE MONITOR or if the problem persists.
3. If you are experiencing a problem which is not described below or you cannot correct the problem, discontinue using the monitor and contact your dealer or iiyama service center for further assistance.

<b>Problem</b>	<b>Check</b>
① The picture does not appear.  (Power indicator does not light up.)  (Power indicator is blue.)  (Power indicator is orange.)	<input type="checkbox"/> The Power Cable is firmly seated in the socket. <input type="checkbox"/> The Power Switch is turned ON. <input type="checkbox"/> The AC socket is live. Please check with another piece of equipment.  <input type="checkbox"/> If the blank screen saver is in active mode, touch the keyboard or the mouse. <input type="checkbox"/> Increase the Contrast and/or Brightness. <input type="checkbox"/> The computer is ON. <input type="checkbox"/> The Signal Cable is properly connected. <input type="checkbox"/> The signal timing of the computer is within the specification of the monitor.  <input type="checkbox"/> If the monitor is in power management mode, touch the keyboard or the mouse. <input type="checkbox"/> The computer is ON. <input type="checkbox"/> The Signal Cable is properly connected. <input type="checkbox"/> The signal timing of the computer is within the specification of the monitor.
② The screen is not synchronized.	<input type="checkbox"/> The Signal Cable is properly connected. <input type="checkbox"/> The signal timing of the computer is within the specification of the monitor. <input type="checkbox"/> The video output level of the computer is within the specification of the monitor.
③ The screen position is not in the center.	<input type="checkbox"/> The signal timing of the computer is within the specification of the monitor.
④ The screen is too bright or too dark.	<input type="checkbox"/> The video output level of the computer is within the specification of the monitor.
⑤ The screen is shaking.	<input type="checkbox"/> The power voltage is within the specification of the monitor. <input type="checkbox"/> The signal timing of the computer is within the specification of the monitor.



## Problem

## Check

- |                                       |                                                                                                                                                                                                                                                                                                                                                                |
|---------------------------------------|----------------------------------------------------------------------------------------------------------------------------------------------------------------------------------------------------------------------------------------------------------------------------------------------------------------------------------------------------------------|
| ⑥ No sound.                           | <input type="checkbox"/> The audio equipment (computer etc.) is ON.<br><input type="checkbox"/> The Audio Cable is properly connected.<br><input type="checkbox"/> The Volume is turned up.<br><input type="checkbox"/> The Mute is OFF.<br><input type="checkbox"/> The audio output level of the audio equipment is within the specification of the monitor. |
| ⑦ The sound is too loud or too quiet. | <input type="checkbox"/> The audio output level of the audio equipment is within the specification of the monitor.                                                                                                                                                                                                                                             |
| ⑧ A strange noise is heard.           | <input type="checkbox"/> The Audio Cable is properly connected.                                                                                                                                                                                                                                                                                                |

# APPENDIX

## SPECIFICATIONS

ENGLISH

LCD Panel	Driving system	a-Si TFT Active Matrix
	Size	Diagonal: 48cm / 19"
	Pixel pitch	0.243mm H × 0.243mm V
	Brightness	300cd/m <sup>2</sup> (Typical)
	Contrast ratio	Static 1000:1 (Typical), DCR function available
	Viewable angle	Right / Left: 85 degrees each    Up / Down: 80 degrees each
	Response time	5ms (Black, white, black)
Display Colors	Approx. 16.7 million maximum	
Sync Frequency	Analog: Horizontal 31.0-80.0kHz, Vertical 55-75Hz	
Maximum Resolution	1680 × 1050, 1.8 MegaPixels	
Input Connector	D-Sub mini 15pin	
Plug & Play	VESA DDC2B™	
Input Sync Signal	Separate sync: TTL, Positive or Negative	
Input Video Signal	Analog: 0.7Vp-p (Standard), 75Ω, Positive	
Input Audio Connector	ø 3.5mm mini jack (Stereo)	
Input Audio Signal	1.0Vrms maximum	
Speakers	1.0W × 2 (Stereo speakers)	
Maximum Screen Size	408.24mm W × 255.15mm H / 16.1" W × 10.0" H	
Power Source	100-240VAC, 50/60Hz, 1.5A	
Power Consumption	38W Typical, Power management mode: 2W maximum*	
Dimensions / Net Weight	439.0 × 365.0 × 190.0mm / 17.3 × 14.4 × 7.5" (W×H×D), 3.7kg / 8.2lbs	
Tilt Angle	Up: 20 degrees, Down: 5 degrees	
Environmental Considerations	Operating: Temperature	5 to 35°C / 41 to 95°F
	Humidity	10 to 80% (No condensation)
	Storage: Temperature	-20 to 60°C / -4 to 140°F
	Humidity	5 to 85% (No condensation)
Approvals	CE, TÜV-GS, TÜV-Ergonomics	

**NOTE** \* Condition: Audio equipment is not connected.

## DIMENSIONS

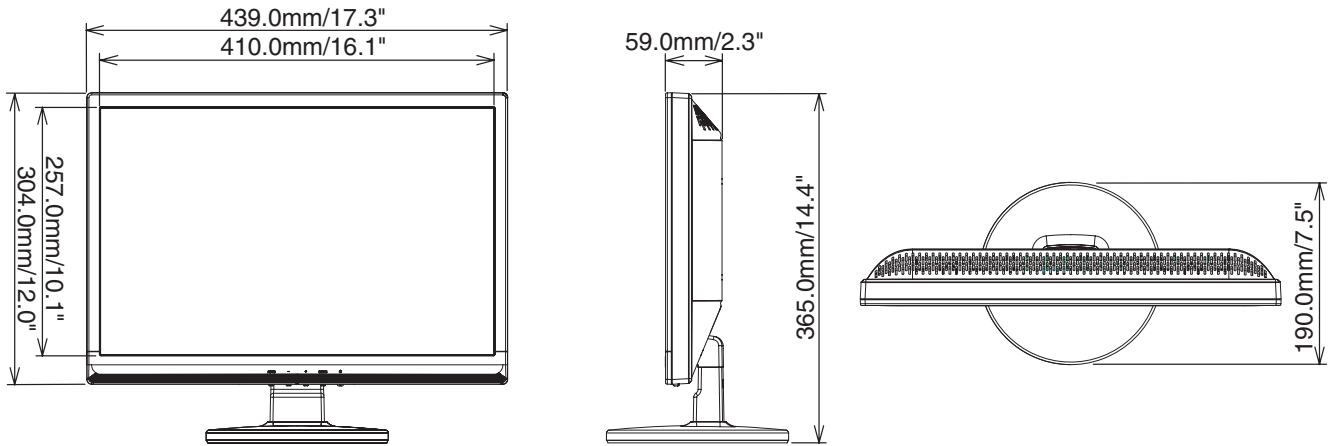

## COMPLIANT TIMING

Video Mode		Horizontal Frequency	Vertical Frequency	Dot Clock
VESA	VGA 640 × 480	31.469kHz	59.940Hz	25.175MHz
		37.500kHz	75.000Hz	31.500MHz
		37.861kHz	72.809Hz	31.500MHz
	SVGA 800 × 600	35.156kHz	56.250Hz	36.000MHz
		37.879kHz	60.317Hz	40.000MHz
		46.875kHz	75.000Hz	49.500MHz
		48.077kHz	72.188Hz	50.000MHz
	XGA 1024 × 768	48.363kHz	60.004Hz	65.000MHz
		56.476kHz	70.069Hz	75.000MHz
		60.023kHz	75.029Hz	78.750MHz
	SXGA 1280 × 1024	63.981kHz	60.020Hz	108.000MHz
		79.976kHz	75.025Hz	135.000MHz
	WXGA+ 1440 × 900	55.935kHz	59.887Hz	106.500MHz
		70.635kHz	74.984Hz	136.750MHz
WSXGA+ 1680 × 1050	65.290kHz	60.000Hz	146.250MHz	
Macintosh	640 × 480	35.000kHz	66.667Hz	30.240MHz
	832 × 624	49.725kHz	74.500Hz	57.283MHz
	1024 × 768	60.150kHz	74.720Hz	80.000MHz