

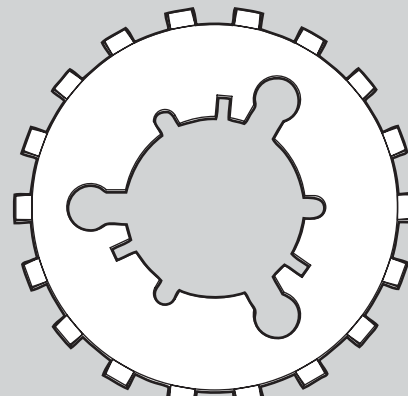







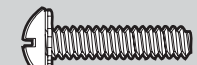
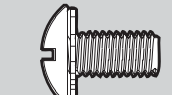

Hardware

(Drawn to Scale)

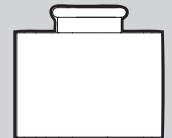
-  **x 1** Low Profile Washer
-  **x 2** 3" Wood Screw
-  **x 4** Flat Washer
-  **x 2** 1.5" Wood Screw
-  **x 3** Screw, Low Profile
-  **x 5** Canopy Screw
-  **x 1** Setscrew
-  **x 4** Mounting Isolator
-  **x 11** Screw, Blade Iron Armature
-  **x 16** Screw, Blade Assembly
-  **x 16** Blade Grommet
-  **x 3** Screw, Switch Housing Assembly
-  **x 3** Screw, Machine, 6-32
-  **x 1** Balancing Kit
-  **x 4** Wire Connector

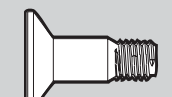
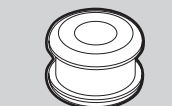
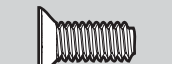
Fan Parts

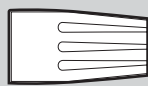
(Not Drawn to Scale)

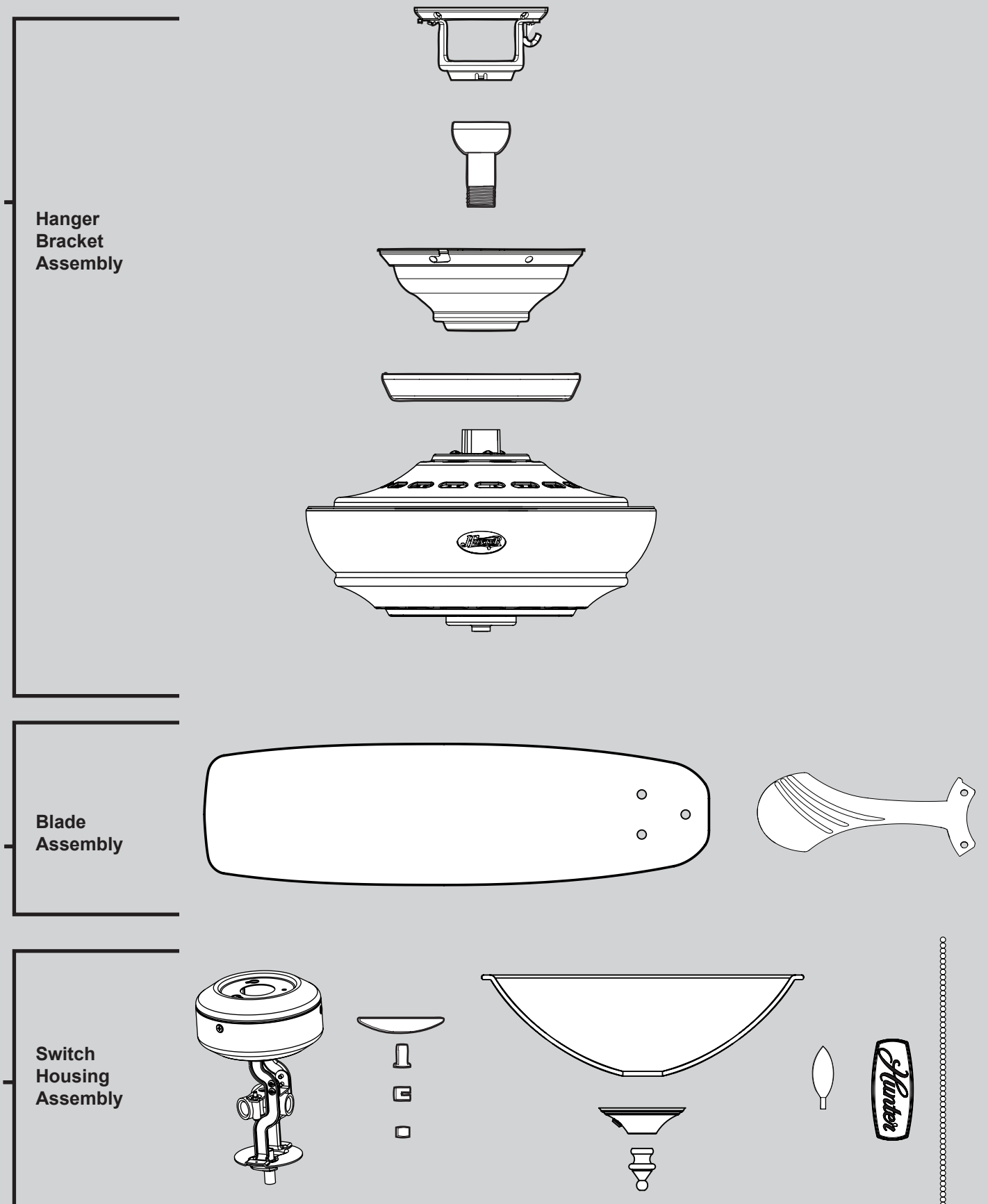

PARTS GUIDE

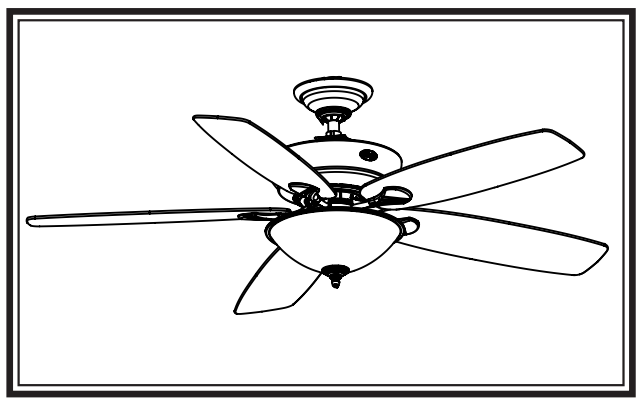

Hunter

Using this Parts Guide, make sure all parts are included in the box. If parts are missing, DO NOT RETURN THIS ITEM TO THE STORE, call 888-830-1326 for assistance. THIS PARTS GUIDE IS FOR REFERENCE ONLY. REFER TO THE INSTALLATION MANUAL FOR FULL ASSEMBLY INSTRUCTIONS.

Parts List			
Item Name	Qty	Model #	28642
		Asm. Dwg. #	99673-02
		Finish	New Bronze
		Brushed Nickel	
* Hanging System Kit	1	96970-09	96970-30
Ceiling Plate			
Canopy			
Canopy Trim Ring			
Hanger Ball / Downrod Assembly			
Setscrew			
Low Profile Washer			
Canopy Screw			
Wood Screw 1.5"			
Wood Screw 3"			
Flat Washer			
Mounting Isolator			
Screw, Low Profile			
Switch Housing Assembly	1	G1291-09	G1291-30
Blade Iron Set	1	92565-05	92565-05
Blade Set	1	G0253-59	G0253-60
Screw, Blade Iron Armature	11	63755-05	63755-05
Hardware Kit	1	99673-00-860	99673-00-861
Blade Grommet			
Blade Assembly Screw			
Screw, Machine, 6-32			
Wire Connector			
Screw, Switch Housing Assembly			
Balancing Kit	1	65666-01	65666-01
Cap, Switch Housing	1	73853-01	73853-01
Plug Button	1	73854-01	73854-01
Dummy Terminal, Male	1	08198-01	08198-01
Dummy Terminal, Female	1	08200-01	08200-01
Bottom Cap	1	G0108-01	G0108-01
Finial	1	67255-01	67255-01
Globe/Shade	1	87333-01	87333-01
Pull Chain Pendant	1	G0090-01	G0090-01
Pull Chain Pendant	1	G0091-01	G0091-01
Pull Chain	2	63756-58	63756-58
Light bulb / Bulb	3	77646-04	77646-04

Materiales

(no dibujados a escala)

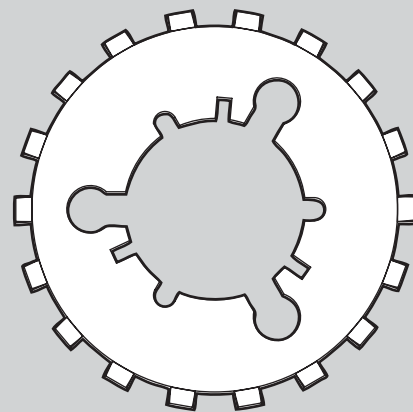

x 1

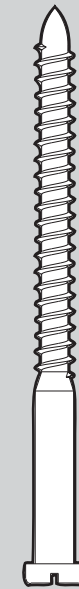

x 2

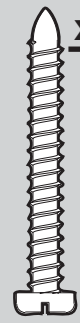

x 2

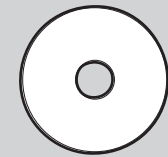

x 4

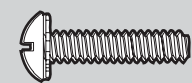

x 3

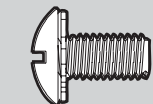

x 5

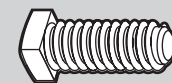

x 1

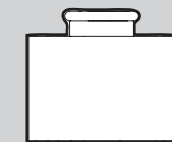

x 4

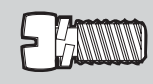

x 11

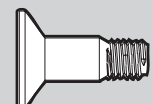

x 16



x 16



x 1



x 4

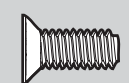

x 3

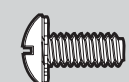

x 3

Piezas del ventilador

(no dibujadas a escala)

Conjunto del soporte de suspensión

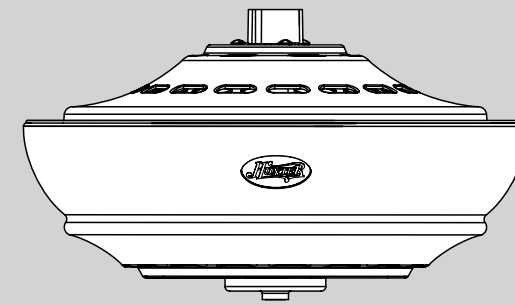
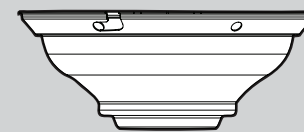
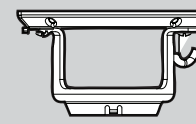

de conjunto de paleta

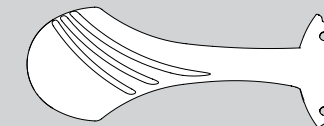

Conjunto del interruptor

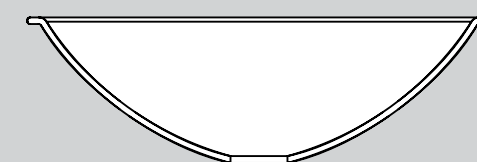
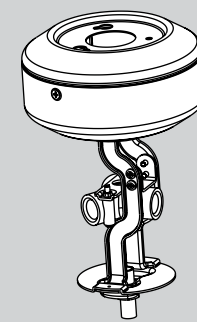

ALTO

GUÍA DE PIEZAS

Hunter

Consulte esta Guía de partes para asegurarse de que todas las partes estén incluidas en la caja.

Si falta alguna parte, NO DEVUELVA ESTE PRODUCTO A LA TIENDA. Solicite ayuda al 888-830-1326. ESTA GUÍA DE PARTES SOLAMENTE ES REFERENCIAL. CONSULTE LAS INSTRUCCIONES COMPLETAS DE ENSAMBLAJE EN EL MANUAL DE INSTALACIÓN

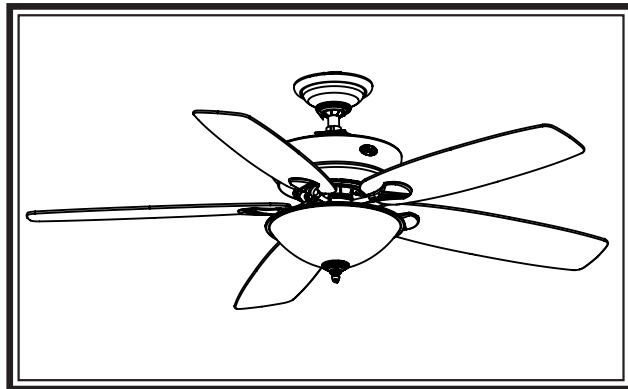

Lista de piezas

Nombre del ítem	Cantidad	No. del modelo	28665	28642
		No. del dibujo de ensamblaje	99673-01	99673-02
		Acabado	Níquel Pulido	Bronce Nuevo
* Kit del sistema de suspensión	1	No. de la pieza	96970-09	96970-30
Placa de techo				
Campana				
Anillo de la moldura de campana				
Bola de suspensión / Conjunto de varilla				
Tornillo prisionero				
Roseta de perfil bajo				
Tornillo, de campana				
Tornillo, de madera				
Tornillo, de madera				
Arandela, plana				
Aislador de montaje				
* Tornillo, de roseta de perfil bajo				
Conjunto del interruptor	1	G1291-09	G1291-30	
Juego de soporte de paletas	1	92565-05	92565-05	
Juego de paletas	1	G0253-59	G0253-60	
Tornillo, de armadura de soporte de paleta	11	63755-05	63755-05	
Kit de materiales	1	99673-00-860	99673-00-861	
Arandela de caucho, de paleta				
Tornillo, de conjunto de paleta				
Tornillo, mecánico, 6-32				
Empalme plástico				
Tornillo, del conjunto de la caja del interruptor				
Kit de equilibrado	1	65666-01	65666-01	
Tapa, Caja del interruptor	1	73853-01	73853-01	
Botón taponador	1	73854-01	73854-01	
Terminal simulado, macho	1	08198-01	08198-01	
Terminal simulado, hembra	1	08200-01	08200-01	
Tope inferior	1	G0108-01	G0108-01	
Cubierta ornamental	1	67255-01	67255-01	
Globo / Pantalla	1	87333-01	87333-01	
Pendiente del tirador de cadena	1	G0090-01	G0090-01	
Pendiente del tirador de cadena	1	G0091-01	G0091-01	
Tirador de cadena	2	63756-58	63756-58	
Bombilla	3	77646-04	77646-04	