

Dell™ Axim™ X50

Owner's Manual

Models HC03U, HC03UL, and HD04U

www.dell.com | support.dell.com

Notes, Notices, and Cautions



NOTE: A NOTE indicates important information that helps you make better use of your computer.



NOTICE: A NOTICE indicates either potential damage to hardware or loss of data and tells you how to avoid the problem.



CAUTION: A CAUTION indicates a potential for property damage, personal injury, or death.

Abbreviations and Acronyms

For a complete list of abbreviations and acronyms, see the "Glossary" on page 163.

**Information in this document is subject to change without notice.
© 2005 Dell Inc. All rights reserved.**

Reproduction in any manner whatsoever without the written permission of Dell Inc. is strictly forbidden.

Trademarks used in this text: *Dell*, the *DELL* logo, *Axim*, *TrueMobile*, *Dimension*, *Inspiron*, *OptiPlex*, *Latitude*, *Dell Precision*, *PowerApp*, *PowerVault*, *PowerEdge*, *PowerConnect*, and *DellNet* are trademarks of Dell Inc.; *Intel*, *Pentium*, and *Celeron* are registered trademarks and *XScale* and *StrataFlash* are trademarks of Intel Corporation; *Microsoft*, *Windows*, *Windows Media*, and *ActiveSync* are registered trademarks and *Windows Mobile* is a trademark of Microsoft Corporation; *Bluetooth* is a registered trademark owned by Bluetooth SIG, Inc. and is used by Dell Inc. under license.

Other trademarks and trade names may be used in this document to refer to either the entities claiming the marks and names or their products. Dell Inc. disclaims any proprietary interest in trademarks and trade names other than its own.

Models HC03U, HC03UL, and HD04U

August 2005 Rev A03

Contents

CAUTION: Safety Instructions	11
SAFETY: General	11
SAFETY: Power	12
SAFETY: Battery	12
SAFETY: Air Travel	13
SAFETY: Electromagnetic Compatibility Instructions	13
When Using Your Device	13
SAFETY: Ergonomic Computing Habits	14
SAFETY: Protecting Against Electrostatic Discharge	14
SAFETY: Battery Disposal	15
Before You Begin	15
Related Information	15
Contacting Dell	16

1 Getting Started

Unpacking Your Device	43
Front, Side, and Back Views	45
Front and Side Views	45
Back View	47

Using the Battery	48
Installing and Removing the Battery	48
Charging the Battery	50
Checking Battery Power	51
Using Your Axim	52
Changing the Display Mode on Your Device	53

2 Operating the Axim

Using the Power Button	55
Using the Stylus	55
Connecting to a Computer	56
Using the Cradle	56
USB Charging	58
Using the Sync Cable	60
Connecting to a Projector	61
Using Cards	61
CompactFlash Cards	61
Secure Digital Memory Cards	63
Resetting the Axim	63
Soft Reset	63
Hard Reset	64
Using Microsoft® Windows Mobile™ Version 5.0 software for Pocket PC Premium Edition	65
Status Icons	65

Programs	66
Program Buttons	66
Switcher Bar	67
Navigation Bar and Command Bar	68
Pop-Up Menus	69
Searching for Information	70
Backing Up Data	71
Entering Information	72
Entering Text Using the Input Panel	72
Typing With the Soft Keyboard	73
Letter Recognizer	74
Block Recognizer	74
Transcriber	75
Writing on the Screen	75
Editing Written Text	76
Drawing on the Screen	79
Creating a Drawing	79
Editing a Drawing	80
Recording a Message	80
Using My Text	81
Adjusting Settings	81
Personal Tab	82
System Tab	82
Connections Tab	83

3 Communicating and Scheduling

About Microsoft® ActiveSync® Program	85
Installing and Using ActiveSync	86
About Microsoft® Pocket Outlook	87
Categories	87
Creating a Category	87
Calendar	88
Using the Summary Screen	89
Creating Meeting Requests	89
Contacts	90
Finding a Contact	91
Using the Summary Screen	91
Tasks	91
Notes	93
Messaging	93
Synchronizing E-Mail Messages	94
Connecting Directly to an E-Mail Server	94
Using the Message List	95
Composing Messages	96
Managing E-Mail Messages and Folders	97
Notifications	98
Beaming an Item	98
Using File Explorer	99

4 Getting Connected

Using Wi-Fi (802.11b)	101
If the Network Card is Set Up	102
If the Wireless Network is Broadcasting SSID	102
If the Wireless Network is Not Broadcasting SSID	103
Using Odyssey Client	104
Adding a Network	104
Using Cisco® LEAP Wireless LAN Security	105
Using Odyssey Client to a Get Certificate of Authority	107
Using Infrared	108
Using Bluetooth® Wireless Technology	108
Creating a Modem Connection	109
Creating an Ethernet Connection	110
Creating a VPN Connection	111
Ending a Connection	111
Connecting Directly to an E-Mail Server	112
Getting Help on Connecting	112

5 Adding and Removing Programs

Adding Programs Using Microsoft® ActiveSync®	115
Downloading Programs From the Internet	116
Adding a Program to the Start Menu	117
Removing Programs	117

6 Using Companion Programs

Word Mobile	119
Excel Mobile	121
Tips for Working in Excel Mobile	122
PowerPoint Mobile	123
MSN Messenger	124
Setting Up	125
Working With Contacts	125
Chatting With Contacts	125
Microsoft Windows Media® Player for Pocket PC	126
Using Internet Explorer Mobile	126
Mobile Favorites	127
Conserving Memory	128
Mobile Favorites Folder	128
Favorite Links	128
Browsing Mobile Favorites and the Web	128

7 Maintenance and Troubleshooting

Maintaining the Axim	131
Installing the Diagnostic Utility	131
Troubleshooting	131
File Download Security Warning	133

8 Appendix

Specifications	135
Dell™ Software License Agreement	139
Regulatory Notices	142
FCC Notices (U.S. Only)	143
IC Notice (Canada Only)	144
Australia and New Zealand	145
NOM Information (Mexico Only)	145
Wireless Regulatory Information	145
Japan Standard	146
Canada—Industry Canada (IC)	146
FCC Standard	146
Mexico	147
Singapore—Approved by IDA for Use in Singapore	147
Brazil	147
Radio Approvals	148

Limited Warranties	149
Limited Warranty for Dell-Branded Hardware Products (U.S. Only)	149
Total Satisfaction Return Policy (U.S. Only)	153
Limited Warranty Terms for Dell-Branded Hardware Products (Canada Only)	154
"Total Satisfaction" Return Policy (Canada Only)	158
Dell Software and Peripherals (Canada Only)	159
1-Year End-User Manufacturer Guarantee (Latin America and the Caribbean Only)	160
Glossary	163
 Index	 165



CAUTION: Safety Instructions

Use the following safety guidelines to help ensure your own personal safety and to help protect your device and working environment from potential damage.

SAFETY: General

- Do not attempt to service the device yourself unless you are a trained service technician. Always follow installation instructions closely.
- If you use an extension power cable with your AC adapter, ensure that the total ampere rating of the products plugged in to the extension power cable does not exceed the ampere rating of the extension cable.
- Do not push objects into air vents or openings of your device. Doing so can cause fire or electric shock by shorting out interior components.
- Keep your device away from radiators and heat sources. Also, do not block cooling vents. Avoid placing loose papers underneath your device; do not place your device in a closed-in wall unit or on a bed, sofa, or rug.
- Place the AC adapter in a ventilated area, such as a desk top or on the floor, when you use it to run the device or to charge the battery. Do not cover the AC adapter with papers or other items that will reduce cooling; also, do not use the AC adapter inside a carrying case.
- The AC adapter may become hot during normal operation of your device. Use care when handling the adapter during or immediately after operation.
- Do not use your device in a wet environment, for example, near a bath tub, sink, or swimming pool or in a wet basement.
- If your device includes an integrated or optional (PC Card) modem, disconnect the modem cable if an electrical storm is approaching to avoid the remote risk of electric shock from lightning via the telephone line.
- To help avoid the potential hazard of electric shock, do not connect or disconnect any cables or perform maintenance or reconfiguration of this product during an electrical storm. Do not use your device during an electrical storm unless all cables have been disconnected and the device is operating on battery power.
- If your device includes a modem, the cable used with the modem should be manufactured with a minimum wire size of 26 American wire gauge (AWG) and an FCC-compliant RJ-11 modular plug.
- PC Cards may become very warm during normal operation. Use care when removing PC Cards after their continuous operation.
- Before you clean your device, disconnect the device from the electrical outlet. Clean your device with a soft cloth dampened with water. Do not use liquid or aerosol cleaners, which may contain flammable substances.

SAFETY: Power

- Use only the Dell-provided AC adapter approved for use with this device. Use of another AC adapter may cause a fire or explosion.
- Before you connect the device to an electrical outlet, check the AC adapter voltage rating to ensure that the required voltage and frequency match the available power source.
- To remove the device from all power sources, turn the device off, disconnect the AC adapter from the electrical outlet, and remove the battery installed in the battery bay.
- To help prevent electric shock, plug the AC adapter and device power cables into properly grounded power sources. These power cables may be equipped with 3-prong plugs to provide an earth grounding connection. Do not use adapter plugs or remove the grounding prong from the power cable plug. If you use a power extension cable, use the appropriate type, 2-prong or 3-prong, to mate with the AC adapter power cable.
- Be sure that nothing rests on your AC adapter's power cable and that the cable is not located where it can be tripped over or stepped on.
- If you are using a multiple-outlet power strip, use caution when plugging the AC adapter's power cable into the power strip. Some power strips may allow you to insert the plug incorrectly. Incorrect insertion of the power plug could result in permanent damage to your device, as well as risk of electric shock and/or fire. Ensure that the ground prong of the power plug is inserted into the mating ground contact of the power strip.

SAFETY: Battery

- Use only Dell™ battery modules that are approved for use with this device. Use of other types may increase the risk of fire or explosion.
- Do not carry a battery pack in your pocket, purse, or other container where metal objects (such as car keys or paper clips) could short-circuit the battery terminals. The resulting excessive current flow can cause extremely high temperatures and may result in damage to the battery pack or cause fire or burns.
- The battery poses a burn hazard if you handle it improperly. Do not disassemble it. Handle a damaged or leaking battery pack with extreme care. If the battery is damaged, electrolyte may leak from the cells and may cause personal injury.
- Keep the battery away from children.
- Do not store or leave your device or battery pack near a heat source such as a radiator, fireplace, stove, electric heater, or other heat-generating appliance or otherwise expose it to temperatures in excess of 60°C (140°F). When heated to excessive temperatures, battery cells could explode or vent, posing a risk of fire.
- Do not dispose of your device's battery in a fire or with normal household waste. Battery cells may explode. Discard a used battery according to the manufacturer's instructions or contact your local waste disposal agency for disposal instructions. Dispose of a spent or damaged battery promptly.

SAFETY: Air Travel

- Certain Federal Aviation Administration regulations and/or airline-specific restrictions may apply to the operation of your Dell device while you are on board an aircraft. For example, such regulations/restrictions may prohibit the use of any personal electronic device (PED) that has the capacity for intentional transmission of radio frequency or other electromagnetic signals while on an aircraft.
 - In order to best comply with all such restrictions, if your Dell portable device is equipped with Dell TrueMobile™ or some other wireless communication device, please disable this device before you board the aircraft and follow all instructions provided by airline personnel with regard to such device.
 - Additionally, the use of any PED, such as a portable device, may be prohibited in aircraft during certain critical phases of flight, for example, takeoff and landing. Some airlines may further define the critical flight phase as any time the aircraft is below 3050 m (10,000 ft). Please follow the airline's specific instructions as to when the use of a PED is allowed.

SAFETY: Electromagnetic Compatibility Instructions

Use shielded signal cables to ensure that you maintain the appropriate electromagnetic compatibility classification for the intended environment. For parallel printers, a cable is available from Dell. If you prefer, you can order a cable from Dell at its worldwide website at www.dell.com.

Static electricity can harm electronic components inside your device. To prevent static damage, discharge static electricity from your body before you touch any of your device's electronic components, such as a memory module. You can do so by touching an unpainted metal surface.

WARNING: Handling the cord on this product, or cords associated with accessories sold with this product, will expose you to lead, a chemical known to the State of California to cause birth defects or other reproductive harm. ***Wash your hands after handling the cord.***

When Using Your Device

Observe the following safe-handling guidelines to prevent damage to your device:

- When setting up the device for work, place it on a level surface.
- When traveling, do not check the device as baggage. You can put your device through an X-ray security machine, but never put your device through a metal detector. If you have the device checked by hand, be sure to have a charged battery available in case you are asked to turn on the device.
- When traveling, do not place the device in overhead storage compartments where it could slide around. Do not drop your device or subject it to other mechanical shocks.
- Protect your device and battery from environmental hazards such as dirt, dust, food, liquids, temperature extremes, and overexposure to sunlight.

- When you move your device between environments with very different temperature and/or humidity ranges, condensation may form on or within the device. To avoid damaging the device, allow sufficient time for the moisture to evaporate before using the device.
-  **NOTICE:** When taking the device from low-temperature conditions into a warmer environment or from high-temperature conditions into a cooler environment, allow the device to acclimate to room temperature before turning on power.
- When you disconnect a cable, pull on its connector or on its strain-relief loop, not on the cable itself. As you pull out the connector, keep it evenly aligned to avoid bending any connector pins. Also, before you connect a cable make sure both connectors are correctly oriented and aligned.
 - Handle components with care. Hold a component such as a memory module by its edges, not its pins.
 - Clean the display with a soft, clean cloth and water. Apply the water to the cloth; then stroke the cloth across the display in one direction, moving from the top of the display to the bottom. Remove moisture from the display quickly and keep the display dry. Long-term exposure to moisture can damage the display. *Do not* use a commercial window cleaner to clean your display.

SAFETY: Ergonomic Computing Habits



CAUTION: Improper or prolonged keyboard use may result in injury.



CAUTION: Viewing the display or external monitor screen for extended periods of time may result in eye strain.

SAFETY: Protecting Against Electrostatic Discharge

Static electricity can harm electronic components inside your device. To prevent static damage, discharge static electricity from your body before you touch any of your device's electronic components, such as a memory module. You can do so by touching an unpainted metal surface.

You can also take the following steps to prevent damage from electrostatic discharge (ESD):

- When unpacking a static-sensitive component from its shipping carton, do not remove the component from the antistatic packing material until you are ready to install the component. Just before unwrapping the antistatic packaging, be sure to discharge static electricity from your body.
- When transporting a sensitive component, first place it in an antistatic container or packaging.
- Handle all sensitive components in a static-safe area. If possible, use antistatic floor pads and workbench pads.

SAFETY: Battery Disposal



Your device uses a lithium-ion battery and a rechargeable NiMH battery. For instructions about replacing the batteries in your device, see "Using the Battery" on page 48.

Do not dispose of the battery along with household waste. Contact your local waste disposal agency for the address of the nearest battery deposit site.

Before You Begin

Related Information

The following table guides you to the information you are looking for in the relevant device and computer documentation.

What Are You Looking For?	Find It Here:
How to set up my device and information on the accessories, connectors, and buttons on my device	The placemat setup diagram and the Dell™ <i>Owner's Manual</i>
Information on using my device	Dell <i>Owner's Manual</i> and Pocket PC Help NOTE: To view Help, tap the Start button and tap Help .
Additional programs that can be installed on my device	<i>Dell Getting Started</i> CD
Information on using programs on my device	Pocket PC Help and, if available, tap Help within a specific program
Connecting to and synchronizing with a computer	Dell <i>Owner's Manual</i> and Microsoft® ActiveSync® <i>Help</i> on your computer To view <i>Help</i> , launch MS ActiveSync, click Help → Microsoft ActiveSync Help .
Last-minute updates and detailed technical information	The readme files, located in the ActiveSync folder on the computer and on the <i>Dell Getting Started</i> CD.

What Are You Looking For?	Find It Here:
Up-to-date information about your Pocket PC	www.microsoft.com/windowsmobile and support.dell.com
My Service Tag and/or Express Service Code	Label located in the battery slot underneath the battery (remove the battery)
Product Key	Located on the COA (Certificate of Authenticity) label on the Getting Started CD
ROM upgrades	To upgrade ROM correctly, see support.dell.com . Read the ROM documentation before attempting to upgrade.

Contacting Dell

To contact Dell electronically, you can access the following websites:

- www.dell.com
- support.dell.com (technical support)
- premiersupport.dell.com (technical support for educational, government, health care, and medium/large business customers, including Premier, Platinum, and Gold customers)

For specific web addresses for your country, find the appropriate country section in the following table.



NOTE: Toll-free numbers are for use within the country for which they are listed.



NOTE: The limited warranty on all Dell-branded products begins on the date of the packing slip or invoice. Before your warranty period expires, call us at one of the numbers provided in table on page 17. Have your Dell Service Code or order number ready while making the call. For details see, "What do I do if I need warranty service?" on page 151.

When you need to contact Dell, use the electronic addresses, telephone numbers, and area codes provided in the following table. If you need assistance in determining which codes to use, contact a local or an international operator.

Remember to have your Dell Service Code ready while making the call.
To find your service code, remove the battery from its slot.

Country (City) International Access Code Country Code City Code	Department Name or Service Area, Website and E-Mail Address	Area Codes, Local Numbers, and Toll-Free Numbers
Anguilla	General Support	toll-free: 800-335-0031
Antigua and Barbuda	General Support	1-800-805-5924
Argentina (Buenos Aires) International Access Code: 00 Country Code: 54 City Code: 11	Website: www.dell.com.ar E-mail: us_latin_services@dell.com E-mail for desktop and portable computers: la-techsupport@dell.com E-mail for servers and EMC® storage products: la_enterprise@dell.com Customer Care Tech Support Tech Support Services Sales	toll-free: 0-800-444-0730 toll-free: 0-800-444-0733 toll-free: 0-800-444-0724 0-810-444-3355
Aruba	General Support	toll-free: 800-1578

Country (City) International Access Code Country Code City Code	Department Name or Service Area, Website and E-Mail Address	Area Codes, Local Numbers, and Toll-Free Numbers
Australia (Sydney)	E-mail (Australia): au_tech_support@dell.com	
International Access Code: 0011 Country Code: 61 City Code: 2	E-mail Customer Care (ANZ): Apcustserv@dell.com E-mail (New Zealand): nz_tech_support@dell.com	
	Home and Small Business	1-300-655-533
	Government and Business	toll-free: 1-800-633-559
	Preferred Accounts Division (PAD)	toll-free: 1-800-060-889
	Customer Care	toll-free: 1333 55 (option 3)
	Technical Support (portables and desktops)	toll-free: 1-300-655-533
	Technical Support (servers and workstations)	toll-free: 1-800-733-314
	Corporate Sales	toll-free: 1-800-808-385
	Transaction Sales	toll-free: 1-800-808-312
	Fax	toll-free: 1-800-818-341

Country (City) International Access Code Country Code City Code	Department Name or Service Area, Website and E-Mail Address	Area Codes, Local Numbers, and Toll-Free Numbers
Austria (Vienna)	Website: support.euro.dell.com	
International	E-mail:	
Access Code: 900	tech_support_central_europe@dell	
Country Code: 43	.com	
City Code: 1	Home/Small Business Sales	0820 240 530 00
	Home/Small Business Fax	0820 240 530 49
	Home/Small Business Customer Care	0820 240 530 14
	Preferred Accounts/Corporate Customer Care	0820 240 530 16
	Home/Small Business Technical Support	0820 240 530 14
	Preferred Accounts/Corporate Technical Support	0660 8779
	Switchboard	0820 240 530 00
Bahamas	General Support	toll-free: 1-866-278-6818
Barbados	General Support	1-800-534-3066

Country (City) International Access Code Country Code City Code	Department Name or Service Area, Website and E-Mail Address	Area Codes, Local Numbers, and Toll-Free Numbers
Belgium (Brussels) International Access Code: 00 Country Code: 32 City Code: 2	Website: support.euro.dell.com E-mail for French-speaking Customers: support.euro.dell.com/be/fr/email dell/ Technical Support for Inspiron XPS computers only Technical Support for all other Dell computers Technical Support Fax Customer Care Corporate Sales Fax Switchboard	02 481 92 96 02 481 92 88 02 481 92 95 02 713 15 .65 02 481 91 00 02 481 92 99 02 481 91 00
Bermuda	General Support	1-800-342-0671
Bolivia	General Support	toll-free: 800-10-0238
Brazil	Website: www.dell.com/br Customer Support, Technical Support Technical Support Fax Customer Care Fax Sales	0800 90 3355 51 481 5470 51 481 5480 0800 90 3390
British Virgin Islands	General Support	toll-free: 1-866-278-6820

Country (City) International Access Code Country Code City Code	Department Name or Service Area, Website and E-Mail Address	Area Codes, Local Numbers, and Toll-Free Numbers
Brunei Country Code: 673	Customer Technical Support (Penang, Malaysia)	604 633 4966
	Customer Service (Penang, Malaysia)	604 633 4888
	Transaction Sales (Penang, Malaysia)	604 633 4955
Canada (North York, Ontario) International Access Code: 011	Online Order Status: www.dell.ca/ostatus	
	AutoTech (automated technical support)	toll-free: 1-800-247-9362
	Customer Care (Home Sales/Small Business)	toll-free: 1-800-847-4096
	Customer Care (med./large business, government)	toll-free: 1-800-326-9463
	Technical Support (Home Sales/Small Business)	toll-free: 1-800-847-4096
	Technical Support (med./large bus., government)	toll-free: 1-800-387-5757
	Technical Support (printers, projectors, televisions, handhelds, digital jukebox, and wireless)	1-877-335-5767
	Sales (Home Sales/Small Business)	toll-free: 1-800-387-5752
	Sales (med./large bus., government)	toll-free: 1-800-387-5755
	Spare Parts Sales & Extended Service Sales	1 866 440 3355
Cayman Islands	General Support	1-800-805-7541
Chile (Santiago) Country Code: 56 City Code: 2	Sales, Customer Support, and Technical Support	toll-free: 1230-020-4823

Country (City) International Access Code Country Code City Code	Department Name or Service Area, Website and E-Mail Address	Area Codes, Local Numbers, and Toll-Free Numbers
China (Xiamen) Country Code: 86 City Code: 592	Technical Support website: support.dell.com.cn Technical Support E-mail: cn_support@dell.com Customer Care E-mail: customer_cn@dell.com	
	Technical Support Fax	592 818 1350
	Technical Support (Dell™ Dimension™ and Inspiron)	toll-free: 800 858 2969
	Technical Support (OptiPlex™, Latitude™, and Dell Precision™)	toll-free: 800 858 0950
	Technical Support (servers and storage)	toll-free: 800 858 0960
	Technical Support (projectors, PDAs, switches, routers, and so on)	toll-free: 800 858 2920
	Technical Support (printers)	toll-free: 800 858 2311
	Customer Care	toll-free: 800 858 2060
	Customer Care Fax	592 818 1308
	Home and Small Business	toll-free: 800 858 2222
	Preferred Accounts Division	toll-free: 800 858 2557
	Large Corporate Accounts GCP	toll-free: 800 858 2055
	Large Corporate Accounts Key Accounts	toll-free: 800 858 2628
	Large Corporate Accounts North	toll-free: 800 858 2999

Country (City) International Access Code Country Code City Code	Department Name or Service Area, Website and E-Mail Address	Area Codes, Local Numbers, and Toll-Free Numbers
	Large Corporate Accounts North Government and Education	toll-free: 800 858 2955
	Large Corporate Accounts East	toll-free: 800 858 2020
	Large Corporate Accounts East Government and Education	toll-free: 800 858 2669
	Large Corporate Accounts Queue Team	toll-free: 800 858 2572
	Large Corporate Accounts South	toll-free: 800 858 2355
	Large Corporate Accounts West	toll-free: 800 858 2811
	Large Corporate Accounts Spare Parts	toll-free: 800 858 2621
Colombia	General Support	980-9-15-3978
Costa Rica	General Support	0800-012-0435
Czech Republic (Prague)	Website: support.euro.dell.com E-mail: czech_dell@dell.com	
International Access Code: 00	Technical Support	22537 2727
Country Code: 420	Customer Care	22537 2707
	Fax	22537 2714
	Tech Fax	22537 2728
	Switchboard	22537 2711

Country (City) International Access Code Country Code City Code	Department Name or Service Area, Website and E-Mail Address	Area Codes, Local Numbers, and Toll-Free Numbers
Denmark (Copenhagen)	Website: support.euro.dell.com E-mail: support.euro.dell.com/dk/da/emaildell/	
International Access Code: 00 Country Code: 45	Technical Support for Inspiron XPS computers only	7010 0074
	Technical Support for all other Dell computers	7023 0182
	Customer Care (Relational)	7023 0184
	Home/Small Business Customer Care	3287 5505
	Switchboard (Relational)	3287 1200
	Switchboard Fax (Relational)	3287 1201
	Switchboard (Home/Small Business)	3287 5000
	Switchboard Fax (Home/Small Business)	3287 5001
Dominica	General Support	toll-free: 1-866-278-6821
Dominican Republic	General Support	1-800-148-0530
Ecuador	General Support	toll-free: 999-119
El Salvador	General Support	01-899-753-0777
Finland (Helsinki)	Website: support.euro.dell.com E-mail: support.euro.dell.com/fi/fi/emaildell/	
International Access Code: 990 Country Code: 358 City Code: 9	Technical Support	09 253 313 60
	Customer Care	09 253 313 38
	Fax	09 253 313 99
	Switchboard	09 253 313 00

Country (City) International Access Code Country Code City Code	Department Name or Service Area, Website and E-Mail Address	Area Codes, Local Numbers, and Toll-Free Numbers
France (Paris) (Montpellier)	Website: support.euro.dell.com E-mail: support.euro.dell.com/fr/fr/emaildell/	
International Access Code: 00	Home and Small Business	
Country Code: 33	Technical Support for Inspiron	0825 387 129
City Codes: (1) (4)	XPS computers only	
	Technical Support for all other Dell computers	0825 387 270
	Customer Care	0825 823 833
	Switchboard	0825 004 700
	Switchboard (calls from outside of France)	04 99 75 40 00
	Sales	0825 004 700
	Fax	0825 004 701
	Fax (calls from outside of France)	04 99 75 40 01
	Corporate	
	Technical Support	0825 004 719
	Customer Care	0825 338 339
	Switchboard	01 55 94 71 00
	Sales	01 55 94 71 00
	Fax	01 55 94 71 01

Country (City) International Access Code Country Code City Code	Department Name or Service Area, Website and E-Mail Address	Area Codes, Local Numbers, and Toll-Free Numbers
Germany (Langen) International Access Code: 00 Country Code: 49 City Code: 6103	Website: support.euro.dell.com	
	E-mail: tech_support_central_europe@dell.com	
	Technical Support for Inspiron XPS computers only	06103 766-7222
	Technical Support for all other Dell computers	06103 766-7200
	Home/Small Business Customer Care	0180-5-224400
	Global Segment Customer Care	06103 766-9570
	Preferred Accounts Customer Care	06103 766-9420
	Large Accounts Customer Care	06103 766-9560
	Public Accounts Customer Care Switchboard	06103 766-9555 06103 766-7000
Greece	Website: support.euro.dell.com	
	E-mail: support.euro.dell.com/gr/en/emaildell/	
	Technical Support	00800-44 14 95 18
	Gold Service Technical Support	00800-44 14 00 83
	Switchboard	2108129810
	Gold Service Switchboard	2108129811
	Sales	2108129800
Fax	2108129812	
Grenada	General Support	toll-free: 1-866-540-3355
Guatemala	General Support	1-800-999-0136
Guyana	General Support	toll-free: 1-877-270-4609

Country (City) International Access Code Country Code City Code	Department Name or Service Area, Website and E-Mail Address	Area Codes, Local Numbers, and Toll-Free Numbers
Hong Kong	Website: support.ap.dell.com	
International Access Code: 001	Technical Support E-mail: apsupport@dell.com	
Country Code: 852	Technical Support (Dimension and Inspiron)	2969 3188
	Technical Support (OptiPlex, Latitude, and Dell Precision)	2969 3191
	Technical Support (PowerApp™, PowerEdge™, PowerConnect™, and PowerVault™)	2969 3196
	Customer Care	3416 0910
	Large Corporate Accounts	3416 0907
	Global Customer Programs	3416 0908
	Medium Business Division	3416 0912
	Home and Small Business Division	2969 3105
India	E-mail Support: India_support_desktop@dell.com India_support_notebook@dell.com India_support_server@dell.com	
	Technical Support	1600 33 8045/ 1600448046
	Sales (Large Corporate Accounts)	1600 33 8044
	Sales (Home and Small Business)	1600 33 8046

Country (City) International Access Code Country Code City Code	Department Name or Service Area, Website and E-Mail Address	Area Codes, Local Numbers, and Toll-Free Numbers
Ireland (Cherrywood) International Access Code: 16 Country Code: 353 City Code: 1	Website: support.euro.dell.com	
	E-mail: dell_direct_support@dell.com	
	Technical Support for Inspiron XPS computers only	1850 200 722
	Technical Support for all other Dell computers	1850 543 543
	U.K. Technical Support (dial within U.K. only)	0870 908 0800
	Home User Customer Care	01 204 4014
	Small Business Customer Care	01 204 4014
	U.K. Customer Care (dial within U.K. only)	0870 906 0010
	Corporate Customer Care	1850 200 982
	Corporate Customer Care (dial within U.K. only)	0870 907 4499
	Ireland Sales	01 204 4444
	U.K. Sales (dial within U.K. only)	0870 907 4000
	Fax/Sales Fax	01 204 0103
	Switchboard	01 204 4444

Country (City) International Access Code Country Code City Code	Department Name or Service Area, Website and E-Mail Address	Area Codes, Local Numbers, and Toll-Free Numbers
Italy (Milan)	Website: support.euro.dell.com	
International Access Code: 00	E-mail: support.euro.dell.com/it/it/emaildell/	
Country Code: 39	Home and Small Business	
City Code: 02	Technical Support	02 577 826 90
	Customer Care	02 696 821 14
	Fax	02 696 821 13
	Switchboard	02 696 821 12
	Corporate	
	Technical Support	02 577 826 90
	Customer Care	02 577 825 55
	Fax	02 575 035 30
	Switchboard	02 577 821
Jamaica	General Support (dial from within Jamaica only)	1-800-682-3639

Country (City) International Access Code Country Code City Code	Department Name or Service Area, Website and E-Mail Address	Area Codes, Local Numbers, and Toll-Free Numbers
Japan (Kawasaki)	Website: support.jp.dell.com	
International Access Code: 001 Country Code: 81 City Code: 44	Technical Support (servers)	toll-free: 0120-198-498
	Technical Support outside of Japan (servers)	81-44-556-4162
	Technical Support (Dimension and Inspiron)	toll-free: 0120-198-226
	Technical Support outside of Japan (Dimension and Inspiron)	81-44-520-1435
	Technical Support (Dell Precision, OptiPlex, and Latitude)	toll-free: 0120-198-433
	Technical Support outside of Japan (Dell Precision, OptiPlex, and Latitude)	81-44-556-3894
	Technical Support (PDAs, projectors, printers, routers)	toll-free: 0120-981-690
	Technical Support outside of Japan (PDAs, projectors, printers, routers)	81-44-556-3468
	Faxbox Service	044-556-3490
	24-Hour Automated Order Service	044-556-3801
	Customer Care	044-556-4240
	Business Sales Division (up to 400 employees)	044-556-1465
	Preferred Accounts Division Sales (over 400 employees)	044-556-3433

Country (City) International Access Code Country Code City Code	Department Name or Service Area, Website and E-Mail Address	Area Codes, Local Numbers, and Toll-Free Numbers
Japan (Kawasaki) International Access Code: 001 Country Code: 81 City Code: 44 <i>(continued)</i>	Large Corporate Accounts Sales (over 3500 employees)	044-556-3430
	Public Sales (government agencies, educational institutions, and medical institutions)	044-556-1469
	Global Segment Japan	044-556-3469
	Individual User	044-556-1760
	Switchboard	044-556-4300
Korea (Seoul) International Access Code: 001 Country Code: 82 City Code: 2	Technical Support	toll-free: 080-200-3800
	Sales	toll-free: 080-200-3600
	Customer Service (Penang, Malaysia)	604 633 4949
	Fax	2194-6202
	Switchboard	2194-6000
	Technical Support (Electronics and Accessories)	toll-free: 080-200-3801
Latin America	Customer Technical Support (Austin, Texas, U.S.A.)	512 728-4093
	Customer Service (Austin, Texas, U.S.A.)	512 728-3619
	Fax (Technical Support and Customer Service) (Austin, Texas, U.S.A.)	512 728-3883
	Sales (Austin, Texas, U.S.A.)	512 728-4397
	SalesFax (Austin, Texas, U.S.A.)	512 728-4600 or 512 728-3772

Country (City) International Access Code Country Code City Code	Department Name or Service Area, Website and E-Mail Address	Area Codes, Local Numbers, and Toll-Free Numbers
Luxembourg International Access Code: 00 Country Code: 352 City Code	Website: support.euro.dell.com	
	E-mail: tech_be@dell.com	
	Technical Support (Brussels, Belgium)	3420808075
	Home/Small Business Sales (Brussels, Belgium)	toll-free: 080016884
	Corporate Sales (Brussels, Belgium)	02 481 91 00
	Customer Care (Brussels, Belgium)	02 481 91 19
	Fax (Brussels, Belgium)	02 481 92 99
Switchboard (Brussels, Belgium)	02 481 91 00	
Macao Country Code: 853	Technical Support	toll-free: 0800 105
	Customer Service (Xiamen, China)	34 160 910
	Transaction Sales (Xiamen, China)	29 693 115
Malaysia (Penang) International Access Code: 00 Country Code: 60 City Code: 4	Website: support.ap.dell.com	
	Technical Support (Dell Precision, OptiPlex, and Latitude)	toll-free: 1 800 88 0193
	Technical Support (Dimension, Inspiron, and Electronics and Accessories)	toll-free: 1 800 88 1306
	Technical Support (PowerApp, PowerEdge, PowerConnect, and PowerVault)	toll-free: 1800 88 1386
	Customer Care	1800-881-306 (Option 6)
	Transaction Sales	toll-free: 1 800 888 202
	Corporate Sales	toll-free: 1 800 888 213

Country (City) International Access Code Country Code City Code	Department Name or Service Area, Website and E-Mail Address	Area Codes, Local Numbers, and Toll-Free Numbers
Mexico	Customer Technical Support	001-877-384-8979
International Access Code: 00 Country Code: 52	Sales	or 001-877-269-3383 50-81-8800
	Customer Service	or 01-800-888-3355 001-877-384-8979
	Main	or 001-877-269-3383 50-81-8800 or 01-800-888-3355
Montserrat	General Support	toll-free: 1-866-278-6822
Netherlands Antilles	General Support	001-800-882-1519
Netherlands (Amsterdam)	Website: support.euro.dell.com	
International Access Code: 00 Country Code: 31 City Code: 20	Technical Support for Inspiron XPS computers only	020 674 45 94
	Technical Support for all other Dell computers	020 674 45 00
	Technical Support Fax	020 674 47 66
	Home/Small Business Customer Care	020 674 42 00
	Relational Customer Care	020 674 4325
	Home/Small Business Sales	020 674 55 00
	Relational Sales	020 674 50 00
	Home/Small Business Sales Fax	020 674 47 75
	Relational Sales Fax	020 674 47 50
	Switchboard	020 674 50 00
	Switchboard Fax	020 674 47 50

Country (City) International Access Code Country Code City Code	Department Name or Service Area, Website and E-Mail Address	Area Codes, Local Numbers, and Toll-Free Numbers
New Zealand International Access Code: 00 Country Code: 64	E-mail (New Zealand): nz_tech_support@dell.com	
	E-mail (Australia): au_tech_support@dell.com	
	E-mail Customer Care (ANZ): Apcustserv@dell.com	
	Customer Care	toll-free: 0800-289-335
	Technical Support (for desktop and portable computers)	toll-free: 0800 446 255
	Technical Support (for servers and workstations)	toll-free: 0800 443 563
	Home and Small Business	0800 446 255
	Government and Business	0800 444 617
	Sales	0800 441 567
Fax	0800 441 566	
Nicaragua	General Support	001-800-220-1006
Norway (Lysaker) International Access Code: 00 Country Code: 47	Website: support.euro.dell.com	
	E-mail: support.euro.dell.com/no/no/email dell/	
	Technical Support	671 16882
	Relational Customer Care	671 17575
	Home/Small Business Customer Care	23162298
	Switchboard	671 16800
Fax Switchboard	671 16865	
Panama	General Support	001-800-507-0962
Peru	General Support	0800-50-669

Country (City) International Access Code Country Code City Code	Department Name or Service Area, Website and E-Mail Address	Area Codes, Local Numbers, and Toll-Free Numbers
Poland (Warsaw)	Website: support.euro.dell.com	
International Access Code: 011	E-mail: pl_support_tech@dell.com	
Country Code: 48	Customer Service Phone	57 95 700
City Code: 22	Customer Care	57 95 999
	Sales	57 95 999
	Customer Service Fax	57 95 806
	Reception Desk Fax	57 95 998
	Switchboard	57 95 999
Portugal	Website: support.euro.dell.com	
International Access Code: 00	E-mail: support.euro.dell.com/pt/en/email	
Country Code: 351	dell/ Technical Support	707200149
	Customer Care	800 300 413
	Sales	800 300 410 or 800 300 411 or 800 300 412 or 21 422 07 10
	Fax	21 424 01 12
Puerto Rico	General Support	1-800-805-7545
St. Kitts and Nevis	General Support	toll-free: 1-877-441-4731
St. Lucia	General Support	1-800-882-1521
St. Vincent and the Grenadines	General Support	toll-free: 1-877-270-4609

Country (City) International Access Code Country Code City Code	Department Name or Service Area, Website and E-Mail Address	Area Codes, Local Numbers, and Toll-Free Numbers
Singapore (Singapore) International Access Code: 005 Country Code: 65	Website: support.ap.dell.com	
	Technical Support (Dimension and Inspiron, and Electronics and Accessories)	toll-free: 1800 394 7430
	Technical Support (OptiPlex, Latitude, and Dell Precision)	toll-free: 1800 394 7488
	Technical Support (PowerApp, PowerEdge, PowerConnect and PowerVault)	toll-free: 1800 394 7478
	Customer Care	1800-394-7430 (Option 6)
	Transaction Sales	toll-free: 1 800 394 7412
	Corporate Sales	toll-free: 1 800 394 7419
Slovakia (Prague)	Website: support.euro.dell.com	
	E-mail: czech_dell@dell.com	
	Technical Support	02 5441 5727
	Customer Care	420 22537 2707
	Fax	02 5441 8328
	Tech Fax	02 5441 8328
	Switchboard (Sales)	02 5441 7585
South Africa (Johannesburg)	Website: support.euro.dell.com	
	E-mail: dell_za_support@dell.com	
	Gold Queue	011 709 7713
	Technical Support	011 709 7710
	Customer Care	011 709 7707
	Sales	011 709 7700
	Fax	011 706 0495
	Switchboard	011 709 7700

Country (City) International Access Code Country Code City Code	Department Name or Service Area, Website and E-Mail Address	Area Codes, Local Numbers, and Toll-Free Numbers
Southeast Asian and Pacific Countries	Customer Technical Support, Customer Service, and Sales (Penang, Malaysia)	604 633 4810
Spain (Madrid)	Website: support.euro.dell.com	
International Access Code: 00 Country Code: 34 City Code: 91	E-mail: support.euro.dell.com/es/es/email dell/	
	Home and Small Business	
	Technical Support	902 100 130
	Customer Care	902 118 540
	Sales	902 118 541
	Switchboard	902 118 541
	Fax	902 118 539
	Corporate	
	Technical Support	902 100 130
	Customer Care	902 115 236
	Switchboard	91 722 92 00
	Fax	91 722 95 83

Country (City) International Access Code Country Code City Code	Department Name or Service Area, Website and E-Mail Address	Area Codes, Local Numbers, and Toll-Free Numbers
Sweden (Upplands Vasby)	Website: support.euro.dell.com E-mail: support.euro.dell.com/se/sv/emaildell/	
International Access Code: 00	Technical Support	08 590 05 199
Country Code: 46	Relational Customer Care	08 590 05 642
City Code: 8	Home/Small Business Customer Care	08 587 70 527
	Employee Purchase Program (EPP) Support	20 140 14 44
	Technical Support Fax	08 590 05 594
	Sales	08 590 05 185
Switzerland (Geneva)	Website: support.euro.dell.com E-mail: Tech_support_central_Europe@dell.com	
International Access Code: 00	E-mail for French-speaking HSB and Corporate Customers: support.euro.dell.com/ch/fr/emaildell/	
Country Code: 41	Technical Support (Home and Small Business)	0844 811 411
City Code: 22	Technical Support (Corporate)	0844 822 844
	Customer Care (Home and Small Business)	0848 802 202
	Customer Care (Corporate)	0848 821 721
	Fax	022 799 01 90
	Switchboard	022 799 01 01

Country (City) International Access Code Country Code City Code	Department Name or Service Area, Website and E-Mail Address	Area Codes, Local Numbers, and Toll-Free Numbers
Taiwan	Website: support.ap.dell.com	
International Access Code: 002 Country Code: 886	E-mail: ap_support@dell.com Technical Support (Portable and Desktop computers) Technical Support (Servers) Customer Care Transaction Sales Corporate Sales	toll-free: 00801 86 1011 toll-free: 00801 60 1256 toll-free: 00801 60 1250 (Option 5) toll-free: 00801 65 1228 toll-free: 00801 651 227
Thailand	Website: support.ap.dell.com	
International Access Code: 001 Country Code: 66	Technical Support (OptiPlex, Latitude, and Dell Precision) Technical Support (PowerApp, PowerEdge, PowerConnect, and PowerVault) Customer Care Transaction Sales Corporate Sales	toll-free: 1800 0060 07 toll-free: 1800 0600 09 1800-006-007 (Option 7) toll-free: 1800 006 006 toll-free: 1800 006 009
Trinidad/Tobago	General Support	1-800-805-8035
Turks and Caicos Islands	General Support	toll-free: 1-866-540-3355

Country (City) International Access Code Country Code City Code	Department Name or Service Area, Website and E-Mail Address	Area Codes, Local Numbers, and Toll-Free Numbers
U.K. (Bracknell)	Website: support.euro.dell.com	
International Access Code: 00 Country Code: 44 City Code: 1344	Customer Care website: support.euro.dell.com/uk/en/ECare/Form/Home.asp E-mail: dell_direct_support@dell.com	
	Technical Support (Corporate/Preferred Accounts/PAD [1000+ employees])	0870 908 0500
	Technical Support (direct and general)	0870 908 0800
	Global Accounts Customer Care	01344 373 186
	Home and Small Business Customer Care	0870 906 0010
	Corporate Customer Care	01344 373 185
	Preferred Accounts (500–5000 employees) Customer Care	0870 906 0010
	Central Government Customer Care	01344 373 193
	Local Government & Education Customer Care	01344 373 199
	Health Customer Care	01344 373 194
	Home and Small Business Sales	0870 907 4000
	Corporate/Public Sector Sales	01344 860 456
	Home and Small Business Fax	0870 907 4006
Uruguay	General Support	toll-free: 000-413-598-2521

Country (City) International Access Code Country Code City Code	Department Name or Service Area, Website and E-Mail Address	Area Codes, Local Numbers, and Toll-Free Numbers
U.S.A. (Austin, Texas) International Access Code: 011 Country Code: 1	Automated Order-Status Service	toll-free: 1-800-433-9014
	AutoTech (portable and desktop computers)	toll-free: 1-800-247-9362
	Consumer (Home and Home Office)	
	Technical Support	toll-free: 1-800-624-9896
	Customer Service	toll-free: 1-800-624-9897
	DellNet™ Service and Support	toll-free: 1-877-Dellnet (1-877-335-5638)
	Employee Purchase Program (EPP) Customers	toll-free: 1-800-695-8133
	Financial Services website: www.dellfinancialservices.com	
	Financial Services (lease/loans)	toll-free: 1-877-577-3355
	Financial Services (Dell Preferred Accounts [DPA])	toll-free: 1-800-283-2210
	Business	
	Customer Service and Technical Support	toll-free: 1-800-822-8965
	Employee Purchase Program (EPP) Customers	toll-free: 1-800-695-8133
Printers and Projectors Technical Support	toll-free: 1-877-459-7298	

Country (City) International Access Code Country Code City Code	Department Name or Service Area, Website and E-Mail Address	Area Codes, Local Numbers, and Toll-Free Numbers
U.S.A. (Austin, Texas) International Access Code: 011 Country Code: 1 (continued)	Public (government, education, and healthcare)	
	Customer Service and Technical Support	toll-free: 1-800-456-3355
	Employee Purchase Program (EPP) Customers	toll-free: 1-800-234-1490
	Dell Sales	toll-free: 1-800-289-3355 or toll-free: 1-800-879-3355
	Dell Outlet Store (Dell refurbished computers)	toll-free: 1-888-798-7561
	Software and Peripherals Sales	toll-free: 1-800-671-3355
	Spare Parts Sales	toll-free: 1-800-357-3355
	Extended Service and Warranty Sales	toll-free: 1-800-247-4618
	Fax	toll-free: 1-800-727-8320
	Dell Services for the Deaf, Hard-of-Hearing, or Speech-Impaired	toll-free: 1-877-DELLTY (1-877-335-5889)
U.S. Virgin Islands	General Support	1-877-673-3355
Venezuela	General Support	8001-3605

Getting Started

Dell Axim X50 and X50v are Dell's relatively new handheld devices (Personal Digital Assistant). Axim X50 refers to the low and mid configurations while Axim X50v refers to the high configuration which has VGA support. See the table for "Accessories" on page 43. The Axim X50/X50v offers:

- built-in wireless (For Mid and High configurations only)
- QVGA and VGA screens
- Small size and weight
- VGA output on Axim X50v

Unpacking Your Device

Your Axim PDA comes with standard accessories and some extra items depending on the model you purchased. Your device packaging contains important information such as the product key on the Getting Started CD cover and the order number on the packing slip. Ensure that you note these down for later use.

While unpacking your device for the first time, check for the following list of items. If you find any item missing, contact Dell support. See, "Contacting Dell" on page 16.

Accessories			
Contents	High	Mid	Low
Axim X50	624 MHz, Wireless, Bluetooth	520 MHz, Wireless, Bluetooth	416 MHz, Bluetooth
Cradle	Standard	Standard	Standard
USB Sync cable	Optional	Optional	Optional
Adapter Connector	Standard	Standard	Standard
standard carrying case	Standard	Standard	Standard
hard copy documentation	Standard	Standard	Standard

Accessories

Contents	High	Mid	Low
Axim X50/X50v Getting Started CD	Standard	Standard	Standard
AC adapter & localized power cord	Standard	Standard	Standard
standard battery (1100 mAH)	Standard	Standard	Standard
High capacity battery* (2200 mAH)	Optional	Optional	Optional
Screen Protectors	Standard	Standard	Standard

Optional: Needs to be ordered separately.

See the following illustration for the standard and optional accessories.

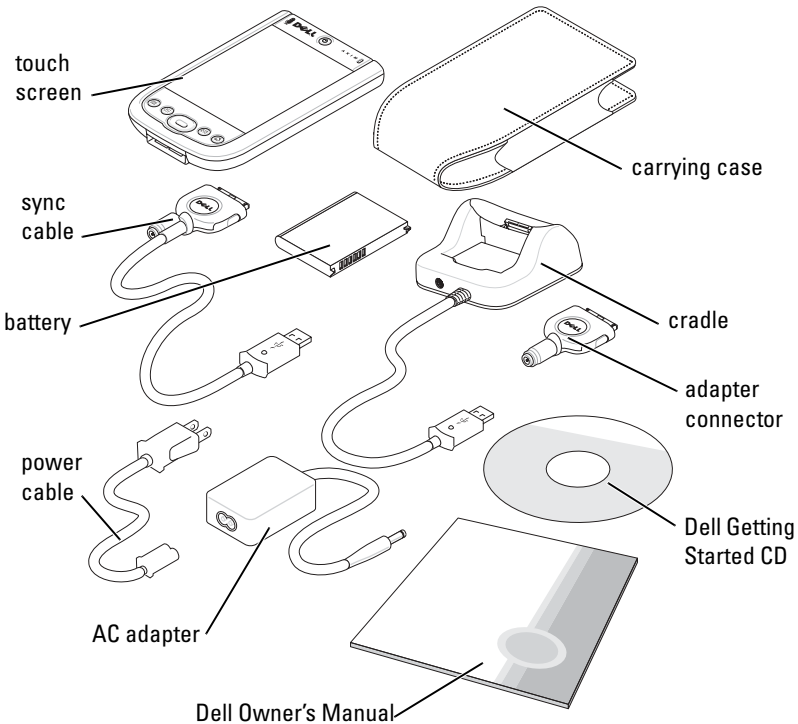

Front, Side, and Back Views

⚠ CAUTION: Before performing any of the procedures in this section, read and follow the safety instructions on page 11.

Front and Side Views

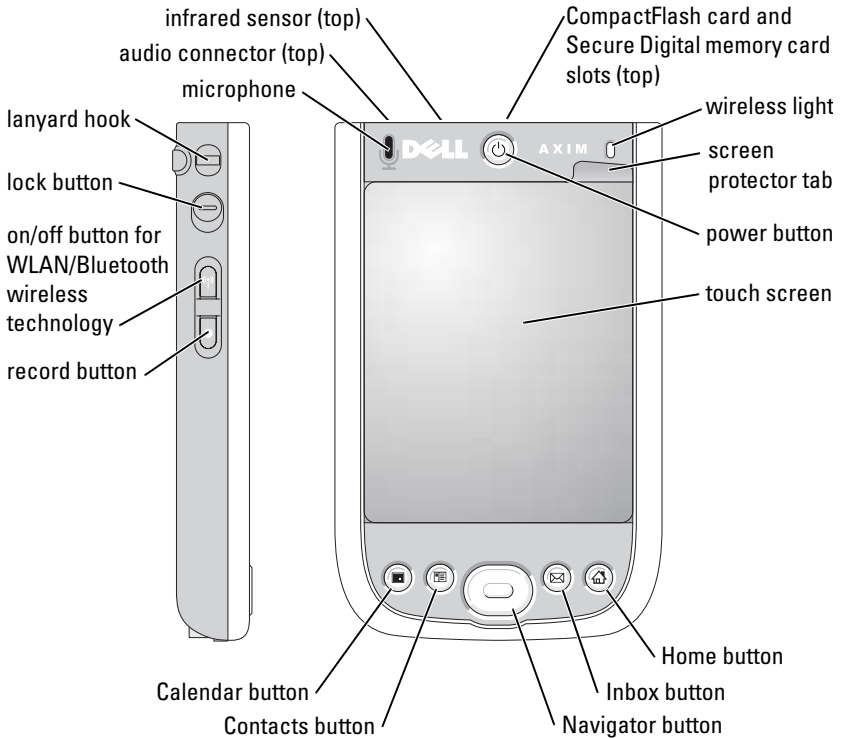

INFRARED SENSOR — Transfer files from your device to another infrared-compatible device without using any cable connection.

MICROPHONE — Use to record audio.

COMPACTFLASH CARD AND SECURE DIGITAL MEMORY CARD SLOTS — See "Using Cards" on page 61 for information on using CompactFlash cards and Secure Digital memory cards.

POWER BUTTON — Press the power button to turn the device on or off. Press and hold the power button to dim the display. Press and hold again to light the display.

TOUCH SCREEN — Enter information through your touchscreen using the stylus. See "Entering Information" on page 72.

SCREEN PROTECTOR — Use screen protectors to protect your device's touchscreen. You must change the protectors with usage to enhance the life of the touchscreen.

ON/OFF BUTTON FOR WLAN/BLUETOOTH® WIRELESS TECHNOLOGY — On wireless devices, the button turns both WLAN and Bluetooth wireless technology on and off. Tap it twice to confirm the turning off or on of WLAN/ Bluetooth. Turn off the wireless devices to conserve power. On Bluetooth devices, the button turns Bluetooth wireless technology on and off.

Current Wireless Status			New Wireless Status	
WLAN	Bluetooth		WLAN	Bluetooth
Off	Off	→	On	On
On	Off		Off	Off
Off	On		Off	Off
On	On		Off	Off

HOME BUTTON — Press to launch the Home window or to turn on the device.

NAVIGATOR BUTTON — Press the right, left, top, or bottom of the Navigator button to move the cursor on the screen. Press the center to enter a selection.

CONTACTS BUTTON — Press to launch Contacts or to turn on the device.

CALENDAR BUTTON — Press to launch Calendar or to turn on the device.

RECORD BUTTON — See "Recording a Message" on page 80 for information on using the record button.

LOCK BUTTON — Switch to lock the device and its touchscreen so that the device does not respond to inadvertent pressing of keys.

Back View

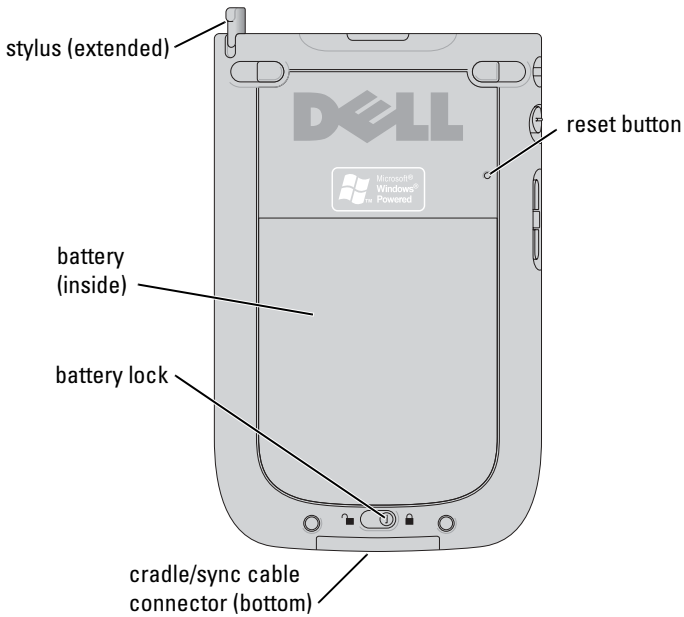

BATTERY LOCK — Use this switch to release and remove the main battery. See "Installing and Removing the Battery" on page 48.

BATTERY — See "Using the Battery" on page 48 for information on the main battery.

CRADLE/SYNC CABLE CONNECTOR — Connect a cradle or sync cable. See "Connecting to a Computer" on page 56.

RESET BUTTON — See "Resetting the Axim" on page 63 for information on using the reset button.

STYLUS — Use the stylus to write or draw on the screen. To remove the stylus, pull it straight up and out of the holder. To avoid losing the stylus, store the stylus in the holder when you are not using it. Ensure that the stylus is oriented correctly when you replace it in the slot.

Using the Battery

Your device ships with a standard 1100 mAH (milli-Ampere-Hour) battery with an expected minimum of 5-8 hours of battery life. A higher capacity 2200 mAH can also be purchased. The 2200 mAH battery has an expected minimum battery life of 10-16 hours.

NOTICE: Do not use your device until you have charged the main battery for at least 8 hours for the first charge.

Before you use your device for the first time, you must charge the battery. Turn on your device using the power button. Once the battery is charged, you can start your device by following the instructions in the operating system to display the Today screen. Use the power button light to monitor the battery charge. See Pocket PC Help on the device, for more information.

Installing and Removing the Battery

To install the battery:

- 1 Ensure that the device is turned off.
- 2 Unlock the battery lock and remove the battery cover.
- 3 Align the battery contacts with the contacts in the battery slot, insert the battery, and lower the battery into the slot until you feel a click.

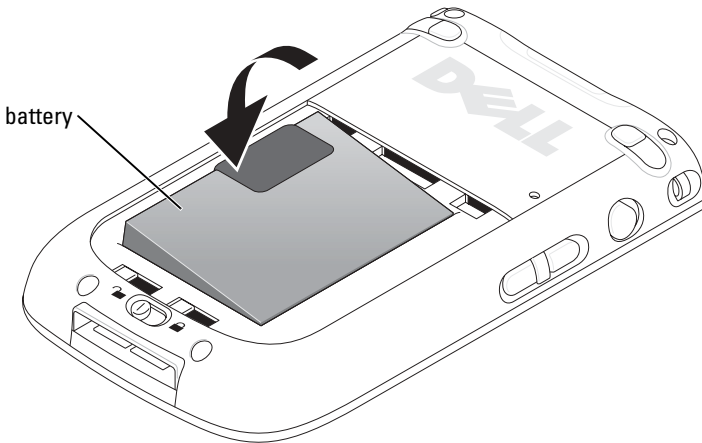

- 4 Close the battery cover.
- 5 Lock the battery cover by sliding the battery lock to the right.

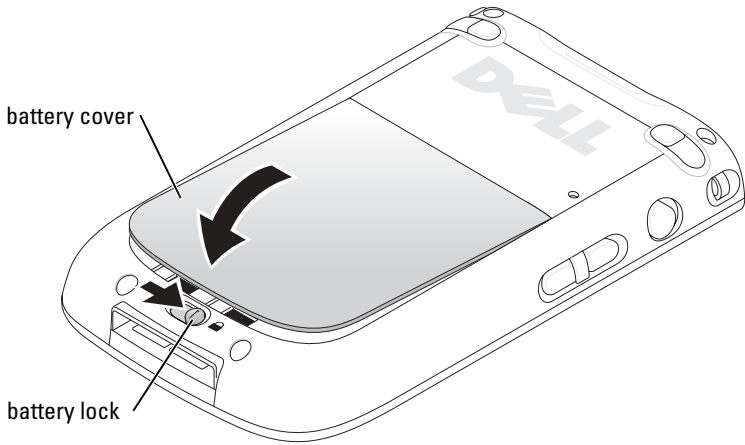

To remove the battery:

- 1 Slide the battery lock to the left to unlock the battery cover.
- 2 Lift the battery cover.

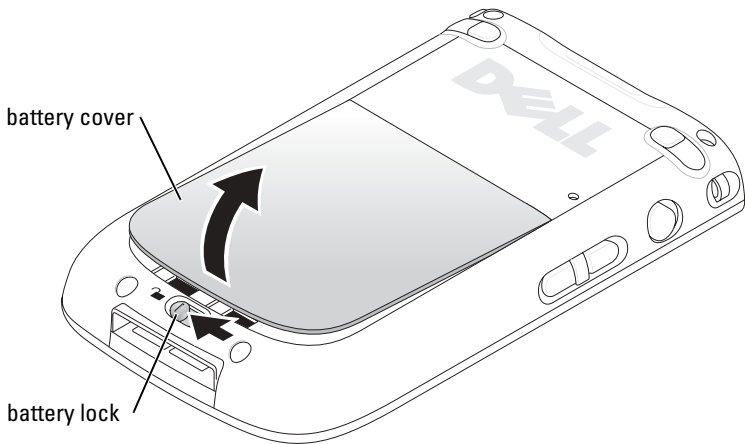

- 3 Pull the tab to lift the battery out of the slot.

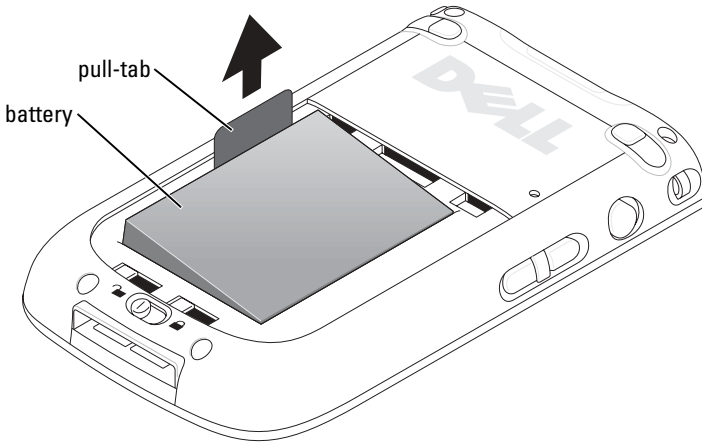

NOTE: Your Service Tag is located underneath the battery in the battery slot. You need your Service Tag to access Dell Support at support.dell.com or to call Dell for customer service or technical support.

Charging the Battery

You must charge your battery before using it for the first time. Subsequently, recharge the battery every time it runs low (power button light flashes amber).

Use one of the following options to charge the main battery:

- Connect the AC adapter directly to the charger adapter and then connect the charger adapter to the device.
- Connect the AC adapter to the sync cable and then connect the sync cable to the device. See, "Using the Sync Cable" on page 60.
- Connect the AC adapter to the cradle, and insert the device into the cradle. See "Using the Cradle" on page 56 for more information.
- Connect the cradle with the device to a running computer. See "USB Charging" on page 58. Also see the placemat for details.

The standard battery pack (1100mAh) completely charges within 5 hours; the higher battery pack (2200mAh) completely charges within 10 hours.

If the main battery is critically low, the device enters "sleep" mode and the device turns off.



NOTE: To prevent data loss, a portion of the main battery will keep data safe for 72 hours if your device enters sleep mode. An additional battery, the internal backup battery, is designed to keep your data safe when you remove the main battery. The internal backup battery will keep data safe for 30 minutes.

To recover from a critically low battery:

- 1 Plug in the AC adapter or replace the main battery with a charged battery.
- 2 Press the power button to turn on the device.

By default, the device turns off if the device is left unused for a period of time. This is called the sleep mode. For information on setting the amount of time during which the device can remain idle before it turns off, see "System Tab" on page 82.

Checking Battery Power

You can check the battery power status with the power button light.

Battery Status	Power Button Light Status
Fully charged battery (and connected to external power)	Solid green
Low charge	Blinking amber
In the process of charging	Solid amber
Notification relay	Blinking green

Using Your Axim

When you turn on your device, or after four hours of inactivity, the **Today** screen appears. You can also view the **Today** screen by tapping the **Start** button and then tapping **Today**. The **Today** screen displays the date and information about the device owner, today's calendar, and important tasks. To customize the **Today** screen:

- 1 Tap **Start** → **Settings**.
- 2 Tap the **Personal** tab → **Today**.
Use the **Appearance** tab to change the background of the **Today** screen.
Use the **Items** tab to change the items that appear on the **Today** screen.

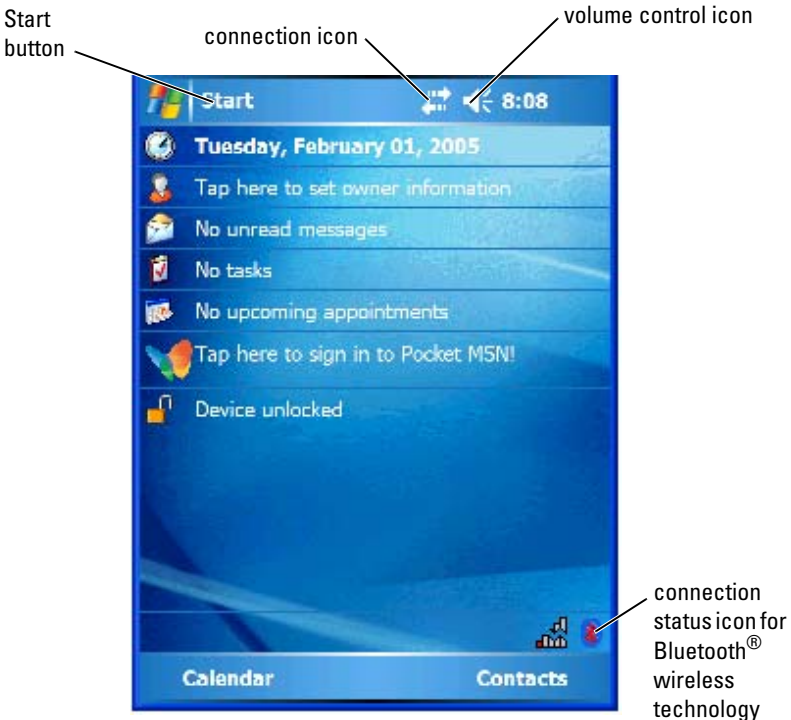

Changing the Display Mode on Your Device

The Axim X50/X50v with Microsoft® Windows Mobile™ Version 5.0 software for Pocket PC Premium Edition can display the screen in both landscape and portrait views.

To change the display mode from landscape to portrait:

- 1 Tap **Start** → **Settings**.
- 2 In the **Settings** window, tap **System** → **Screen**.
- 3 In the **Screen** window, tap **Portrait** to select portrait mode.
 **NOTE:** To change the display mode from portrait to landscape, tap **Landscape**.
- 4 Tap **OK** and close the window.

Operating the Axim

Using the Power Button

Press the power button to turn the device on or off. Press and hold the power button to dim the display. This is the power saver mode. Press and hold again to light the display.

- When the device is connected to external power and the main battery is fully charged, the power button light is solid green.
- When the main battery charge is low, the power button light flashes amber.
- When the battery is being charged, the power button light is solid amber.
- When the device relays a notification, the power button light rapidly flashes green.

Using the Stylus

Your device has a stylus for selecting items and entering information. On the device, the stylus replaces the mouse:

- Tap — Touch the screen once with the stylus to open items and select options.
- Drag — Hold the stylus on the screen and drag to select text and images. Drag on a list to select multiple items.
- Tap and hold — Tap and hold the stylus on an item to see a list of actions available for that item. On the pop-up menu that appears, tap the action you want to perform.

See "Entering Information" on page 72 for more information.

Connecting to a Computer

You can either connect your device to a computer using a cradle or directly to a computer using a sync cable. Connect your device to a computer to:

- Add programs to your device. See "Adding Programs Using Microsoft® ActiveSync®" on page 115 for more information.
- Synchronize data on your device with data on your computer.

For information on synchronizing your data, see the following resources:

- ActiveSync Help on your computer
- ActiveSync Help on your device

Using the Cradle



NOTE: Depending on the configuration of your device, the cradle is optional.

You can use the cradle to:

- Synchronize the data on your device with the data on your computer.
- Connect the device to an electrical outlet to conserve battery power.
- Charge the main battery. See "Using the Battery" on page 48 for more information.
- Charge a spare battery. Please note that the spare battery is optional.



NOTE: Before connecting your device to a computer for the first time, install ActiveSync on the computer using the *Dell™ Getting Started CD*.

To connect your device to the cradle:

- 1 Connect the AC adapter to the cradle and to an electrical outlet.
- 2 Place the Axim in the docking cradle near your computer.
- 3 Connect the USB sync cable to the cradle and the computer.

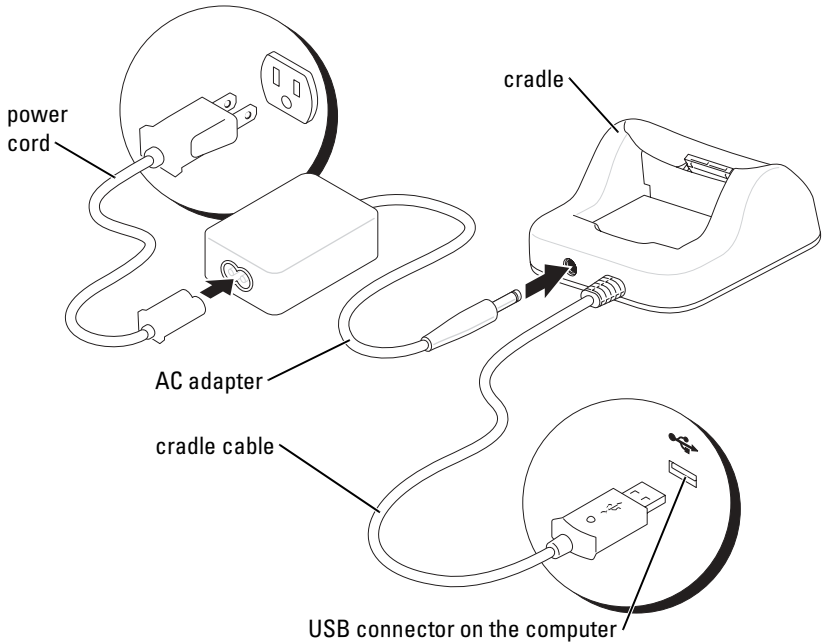

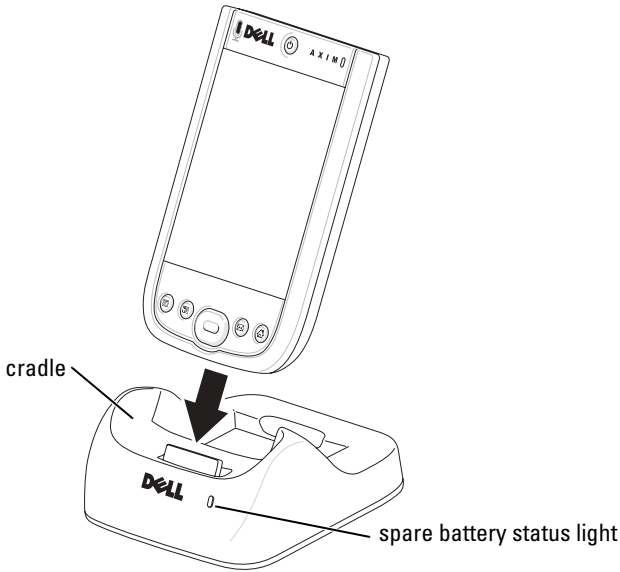

When the device is docked in the cradle, the power button on the device turns on and the connection status icon appears on the command bar (see page 65).

NOTE: The power button on the device indicates the charge status of the main battery. See the description of the power button lights on page 55 for more information.

The spare battery status light on the cradle operates as follows:

- Green — The spare battery is fully charged.
- Amber — The spare battery is charging.

To remove the device from the cradle, pull the device straight up and out of the cradle.

USB Charging

You can charge your device battery when the cradle with the device is connected to a running computer by a USB cable.

NOTE: USB charging will not take place if the device is turned on.

You can charge the battery using a 5V/500 mA USB port when the device is turned off.

 **NOTE:** Using an external USB hub with 5V/100 mA ports to charge the device battery may cause a temporary voltage drop in the hub, and other USB devices connected to the ports on the hub may not work normally until the device is removed.

 **NOTE:** Charging the battery through a USB port takes more time than direct AC adapter charging.

The device charger stops the charging process after seven hours. If you need more than seven hours to charge the device battery, disconnect and reconnect the USB cable to restart the charging process.

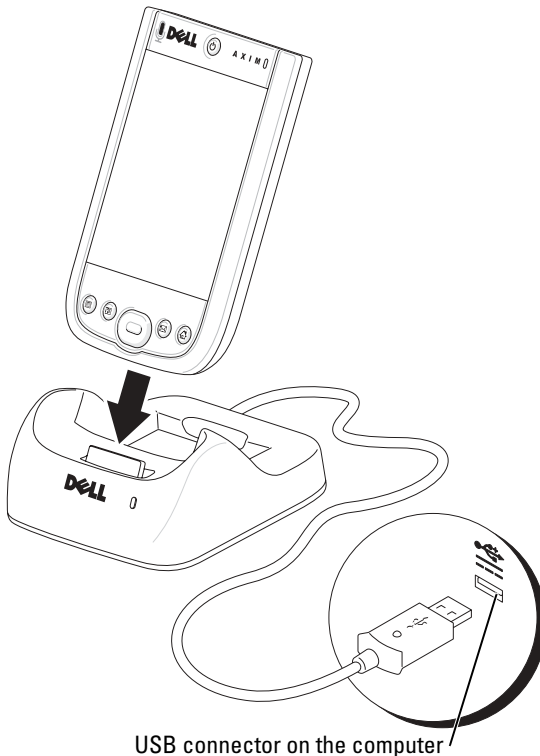

Using the Sync Cable

Use the sync cable to connect your device directly to the computer without using the cradle.

NOTE: The sync cable is optional depending on the configuration of your device.

To connect the sync cable:

- 1 Connect the sync cable connector to your device. Ensure that the Dell logo is facing upwards.
- 2 Connect the USB connector of the cable to the USB connector on your computer.

NOTICE: To avoid damaging the sync cable connector, press the two buttons on the sides of the connector to release the lock before inserting or pulling out the connector.

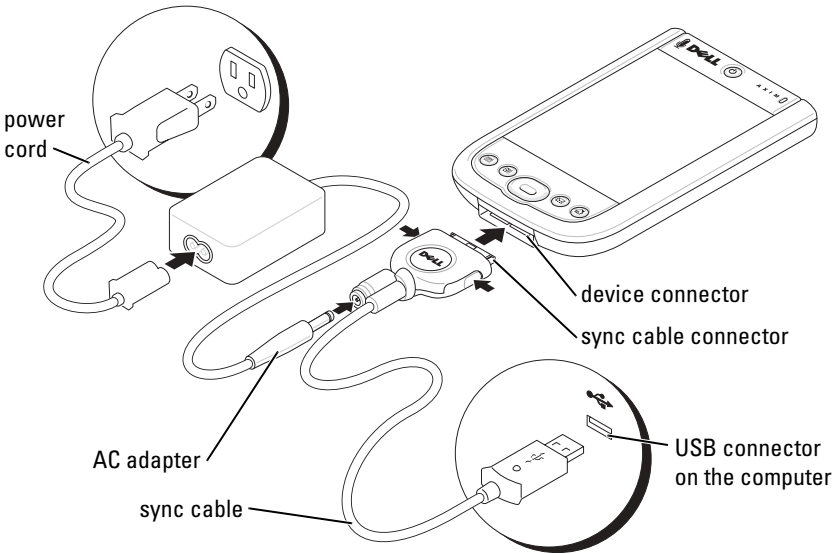

Connecting to a Projector

You can connect the device to a projector using a VGA cable.



NOTE: The VGA option is available only with the VGA model of the device. The VGA cable will not ship with your device unless you order it.



NOTE: You need to install the **Viewer** program from the CD for the device to detect the projector. To configure the program, see the **Help** section in the program.

To connect the device to the projector, connect the sync connector on the VGA cable to the device, and then connect the other connector of the VGA cable to the projector cable. Run the **Viewer** program for the device to detect the projector.

Using Cards

Your device has two slots located on the top of the unit. The larger slot supports CompactFlash Type II cards. The smaller slot supports Secure Digital (SD) memory cards, Secure Digital I/O (SDIO) cards, and the MultiMediaCard (MMC). All three memory card types are available in sizes from 64 MB to 1 GB or 2 GB.

CompactFlash Cards

Your device supports CompactFlash Type II cards. Some common types of cards include:

- Modem — Connect a telephone line for modem data communication.
- Wireless communication — Data communication without the use of cable connections. You can use cards, such as internal cards with Bluetooth wireless technology and 802.11b wireless LAN.
- Storage — Save data or install programs on a storage card.

When you do not have a CompactFlash card installed, insert the plastic blank to protect the CompactFlash card slot.

To install a CompactFlash card:

- 1 If a blank is installed, remove it.

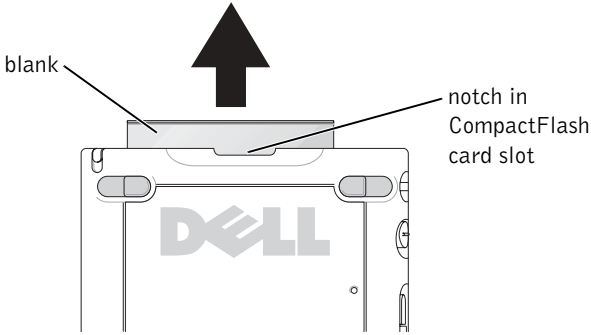

- 2 Align the tab on the back of the CompactFlash card with the notch in the CompactFlash card slot, and slide the card into the slot.

NOTICE: Do not force the card. If you feel resistance, remove the card, check the orientation, and reinsert it.

See the documentation that came with the card for more information.

Secure Digital Memory Cards

Use Secure Digital memory cards to save or back up data.

To install a Secure Digital memory card:

- 1 If a card or plastic blank is already installed, press in to release it, and then remove it.

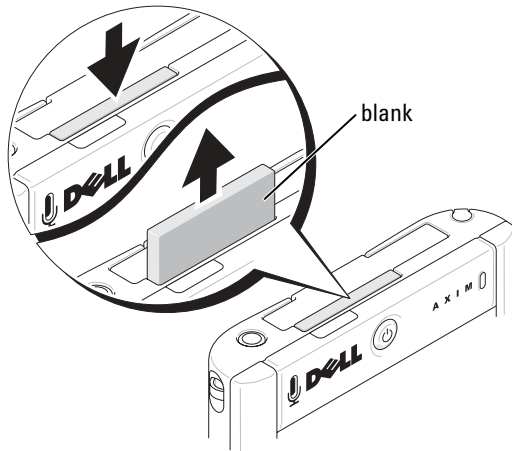

- 2 Ensure that the card is oriented correctly, and slide it into the slot until you feel a click.

NOTICE: Do not force the card. If you feel resistance, remove the card, check the orientation, and reinsert it.

See the documentation that came with the card for more information.

Resetting the Axim

Soft Reset

When you do a soft reset, the device deletes any data that has not been saved in the ROM. In other words, your saved files and programs are not deleted. Try a soft reset if the device does not respond when you tap the display or press a button.

To do a soft reset, use the stylus to press the reset button.

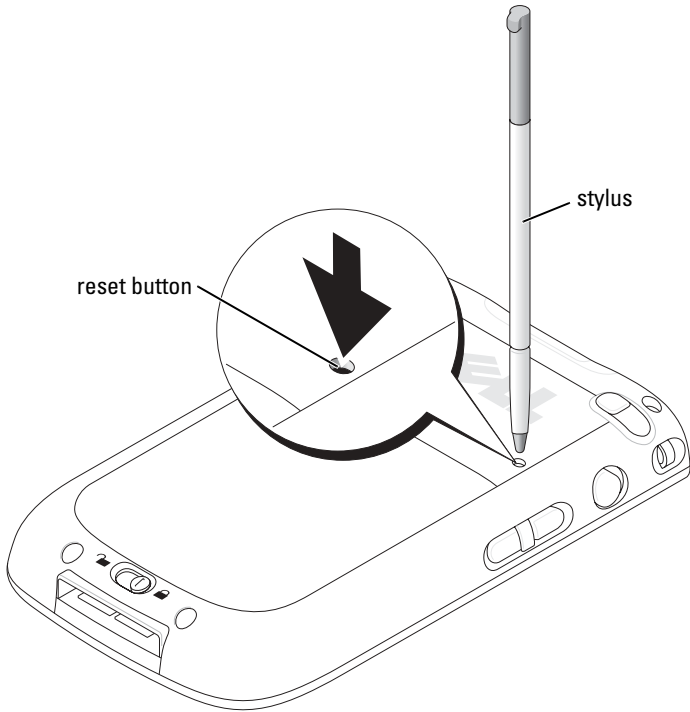

Hard Reset



NOTICE: When you do a hard reset, you lose all the data stored in your device flash memory, and any programs that you installed on your device.

Do a hard reset if:

- You want to restore the device to factory default settings.
- You forget your password and need to reset it.
- Your device is experiencing severe operational problems and you have already attempted a soft reset.



NOTICE: It is strongly recommended that you back up your data before you do a hard reset. See your *Getting Started Guide* that is available on the upgrade CD.



To do a hard reset:









- 1 Press and hold the power button.
- 2 Using the stylus, hold down the reset button for about 2 seconds.
- 3 Follow the instructions on the screen.





Using Microsoft® Windows Mobile™ Version 5.0 software for Pocket PC Premium Edition

The Windows Mobile 5.0 operating system comes with a host of new features and interface improvements. The screen view and touchpad is similar to Windows™ XP for computers. RAM is only used for running applications. ROM is where all application, PIM data, and file storage happens. For details, visit the www.microsoft.com website.

Status Icons

 **NOTE:** If there is not enough space to display all notification icons on the device, tap , icon to view the hidden list of icons.

Icon	Description
	New e-mail or text message (SMS)
	New instant message
	Battery level
	Low battery
	Battery charging
	No battery
	Sync Error
	Volume off

Icon	Description
	Bluetooth
	Wi-Fi on
	Wi-Fi data call
	Help icon

Programs

You can switch from one program to another by selecting a program from the **Start** menu. To access programs that are not listed in the **Start** menu, tap **Start** → **Programs**, and then tap the program name.



NOTE: Some programs have abbreviated labels for check boxes and drop-down menus. To see the full spelling of an abbreviated label, tap and hold the stylus on the label. Drag the stylus off the label so that the command is not carried out.

Program Buttons

You can also switch to some programs by pressing a program button. Your device has four program buttons located on the front of the device. The icons on the buttons identify the programs which they start. By default, the buttons launch Home, Messaging, Contacts, and Calendar.

Switcher Bar

You can also use Switcher Bar to switch to or close the open programs. To launch Switcher Bar:







- 1 Tap **Start** → **Settings**.
- 2 Tap **System** → **Switcher Bar**.





The Switcher Bar icon, , appears in the navigation bar.

Tap  to view a list of all open programs. In the **Switcher Bar** menu:

- Tap **Brightness settings** or **Power settings** to configure those settings.
- Tap a program name to switch to that program.
- Tap **Exit current program** to close the current program.
- Tap **Exit all programs** to close all open programs.
- Tap **Exit Switcher Bar** to close the menu.

The following table contains a partial list of programs that are on your device. See the *Dell™ Getting Started* CD for additional programs that you can install on your device.

Icon	Program	Description
	ActiveSync	Synchronize information between your device and your computer.
	Calendar	Keep track of your appointments and create meeting requests.
	Contacts	Keep track of your friends and colleagues.
	Messaging	Send and receive e-mail messages.
	Internet Explorer Mobile	Browse websites and WAP sites, and download new programs and files from the Internet.
	Notes	Create handwritten or typed notes, drawings, or recordings.
	Tasks	Keep track of your tasks.

Icon	Program	Description
	Excel Mobile	Create new workbooks or view and edit Excel workbooks that you created on your computer.
	Pocket MSN	Send and receive instant messages with your MSN Messenger contacts.
	Word Mobile	Create new documents or view and edit Word documents that you created on your computer.
	PowerPoint Mobile	View PowerPoint presentation slides.

Navigation Bar and Command Bar

The navigation bar is located at the top of the screen. It displays the active program and current time, and allows you to switch to other programs or close screens.

Use the command bar at the bottom of the screen to perform tasks in programs. The command bar includes menu names, icons, and the input panel icon. To create a new item in the current program, tap **New**. To see the name of an icon, tap and hold the stylus on the icon. Drag the stylus off the icon so that the command is not carried out.

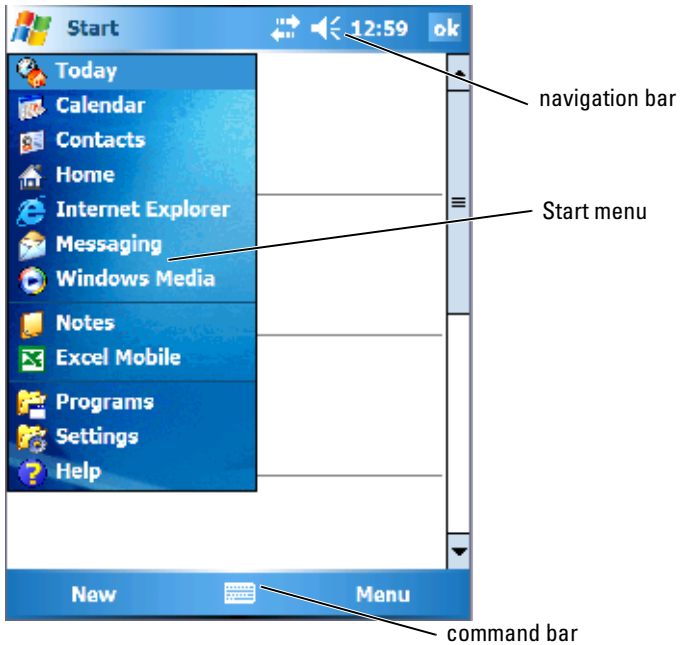

Pop-Up Menus

With pop-up menus, you can quickly select an action for an item. For example, you can use the pop-up menu in the contact list to delete a contact, make a copy, or send an e-mail message to a contact. The actions in the pop-up menu vary from program to program. To access a pop-up menu, tap and hold the stylus on an item name. When the menu appears, lift the stylus and tap the action you want to perform. To close the menu without performing an action, tap anywhere outside the menu.

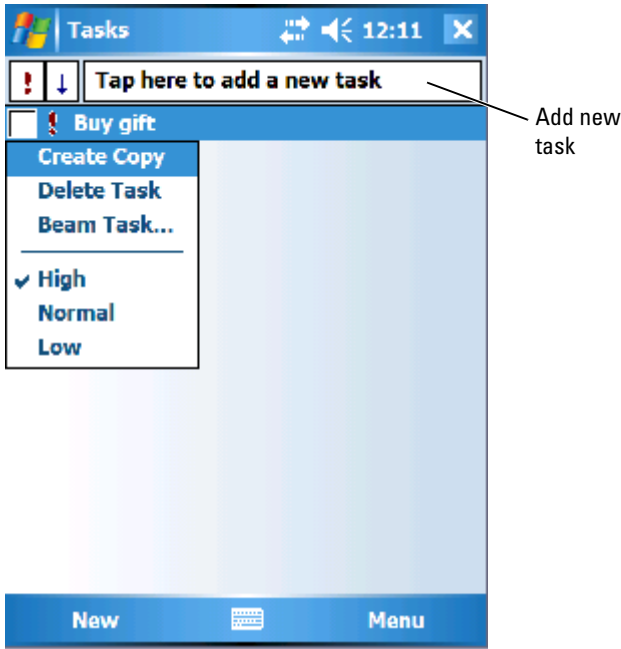

Searching for Information

The Search feature on your device helps you to quickly locate information.

To search for files or other items:

- 1 Tap **Start** → **Programs** → **Search**.
- 2 In **Search for**, enter the file name, word, or other information you want. If you have looked for this item before, tap the **Search for** arrow to select the item from the list.
- 3 In **Type**, select a data type to help narrow your search.
- 4 Tap **Search**.
The **My Documents** folder and subfolders are searched.
- 5 In the **Results** list, tap the item you want to open.

You can also use **File Explorer** to find files on your device and to organize your files into folders. On the **Start** menu, tap **Programs** → **File Explorer**.

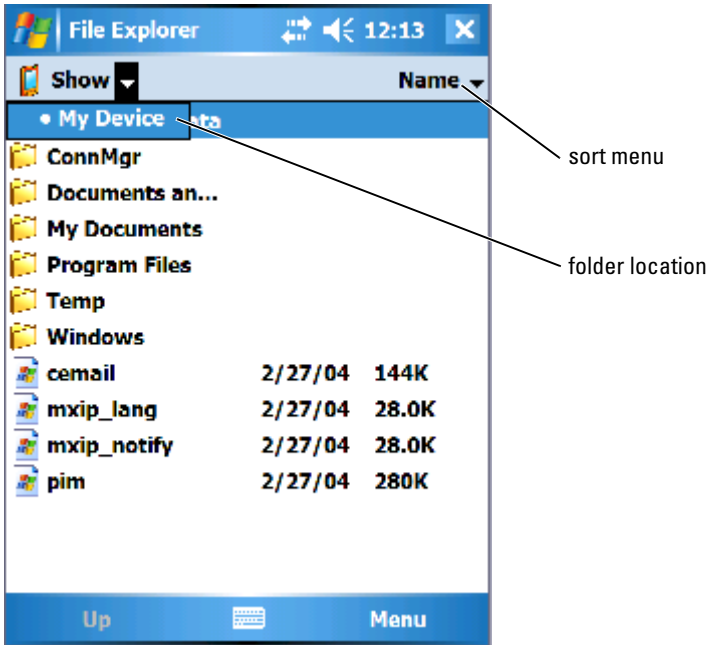

Backing Up Data

To prevent or minimize data loss, you should periodically back up the data stored on your device. Use ActiveSync to synchronize the files on your device with the files on your computer. You can also drag and drop files from your device to your computer using Windows Explorer. See the ActiveSync Help on your computer for additional information. Also see, "Installing and Using ActiveSync" on page 86.



NOTE: To prevent data loss, a portion of the main battery will keep data safe for 72 hours if your device runs out of power. An additional battery, the internal backup battery, is designed to keep your data safe when you remove the main battery. The internal backup battery will keep data safe for 30 minutes.

Entering Information

You have several options for entering information:

- Use the input panel to enter typed text using the soft keyboard or another input method.
- Write directly on the screen using the stylus.
- Draw pictures on the screen with the stylus.
- Speak into your device microphone to record a message.

Use Microsoft® ActiveSync® to synchronize or copy information from your computer to your device. For more information, see ActiveSync Help on your computer.



NOTE: Some of the functions mentioned in this section may not be supported by the operating system in some languages.

Entering Text Using the Input Panel

Use the input panel to enter information into any program on your device. You can type using the soft keyboard or write with the stylus using Letter Recognizer, Block Recognizer, or Transcriber. The characters appear as typed text on the screen.

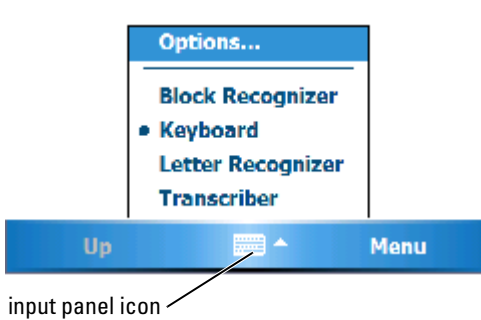

To show or hide the input panel, tap the input panel icon. Tap the arrow next to the input panel icon to change the input method.

When you use the input panel, your device anticipates the word you are typing or writing and displays it above the input panel. When you tap the displayed word, the word is inserted at the insertion point. The more you use your device, the more words it learns to anticipate.

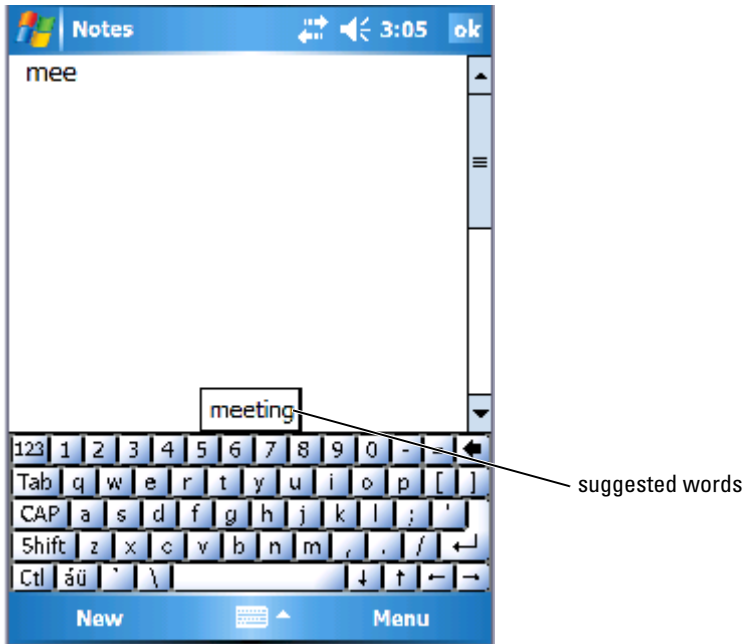

To change word suggestion options, for example, the number of words suggested:

- 1 Tap Start → Settings → Personal → Input.
- 2 Tap the Word Completion tab.
- 3 Select the desired settings and tap OK.

Typing With the Soft Keyboard

- 1 Tap the input selection arrow and tap **Keyboard**.
- 2 Tap the keys on the soft keyboard with your stylus.

Letter Recognizer

Letter Recognizer allows you to use your stylus to write letters on the screen as you would write them on paper.



NOTE: Letter Recognizer is included with the English, French, German, Italian, and Spanish operating systems. Other versions do not support Letter Recognizer.

- 1 Tap the input selection arrow and tap **Letter Recognizer**.
- 2 Write characters, numbers, and symbols in the designated writing area.
 - Enter capital letters by writing in the ABC (left) area of the box.
 - Enter lower case letters by writing in the abc (middle) area of the box.
 - Enter numbers by writing in the 123 (right) area of the box.
 - Enter punctuation and symbols by tapping in any area of the box and then writing the desired character.

The letters are converted to typed text on the screen. For specific instructions on using Letter Recognizer, tap the question mark next to the writing area.



NOTE: Tap **Demo** to learn the character strokes that the device can recognize.

Block Recognizer

Block Recognizer allows you to use character strokes that are similar to those used on other handheld devices.



NOTE: Block Recognizer is included with the English, French, German, Italian, and Spanish operating systems. Other versions do not support Block Recognizer.

- 1 Tap the input selection arrow and tap **Block Recognizer**.
- 2 Write characters, numbers, and symbols in the designated writing area.
 - Enter letters by writing in the abc (left) area of the box.
 - Enter numbers by writing in the 123 (right) area of the box.
 - Enter symbols and punctuation by tapping in either area of the box and then writing the desired character.

The character strokes are converted to typed text on the screen. For specific instructions on using Block Recognizer, tap the question mark next to the writing area.



NOTE: Tap **Demo** to learn the character strokes that the device can recognize.

Transcriber

Transcriber allows you to write anywhere on the screen using the stylus similar to the way that you would write on paper. Unlike Letter Recognizer and Block Recognizer, you can write a sentence or more, and then pause to let Transcriber change the written characters to typed characters.



NOTE: Transcriber is included with the English, French, and German operating systems. Other versions do not support Transcriber.

- 1 Start a program such as Word Mobile.
- 2 Tap the Input Panel icon at the bottom center of the screen and tap the input selection arrow to the right of the icon.
- 3 Tap **Transcriber**.
The Transcriber introductory screen appears.
- 4 With your stylus, write anywhere on the screen.

When you pause, Transcriber converts your written characters to typed characters. For specific instructions on using Transcriber, tap the question mark in the lower right hand corner of the screen.

Writing on the Screen

In any program that accepts written text, such as the Notes program and the **Notes** tab in some programs, you can use your stylus to write directly on the screen. You can edit and format what you have written and convert the information to text at a later time.

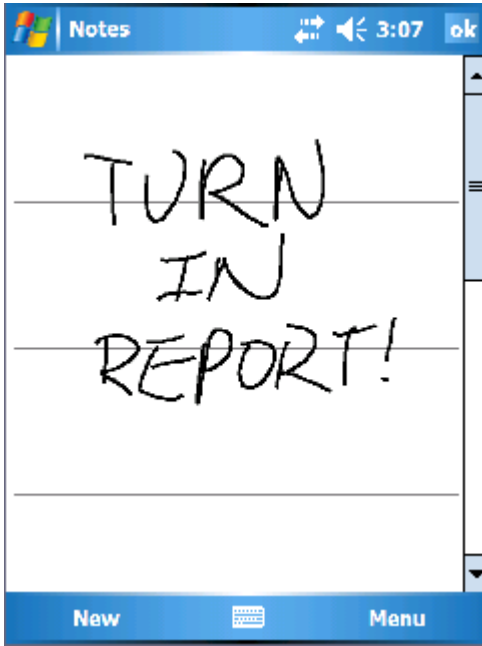

Editing Written Text

To edit or format written text:

- 1 Drag the stylus across the text that you want to select.
- 2 Tap and hold the selected text.
- 3 Tap the appropriate editing command in the pop-up menu.

You can also tap **Menu** → **Edit** at the bottom of the screen to select editing commands.

To convert written text to print-style text, tap **Menu** → **Tools** and tap **Recognize**.

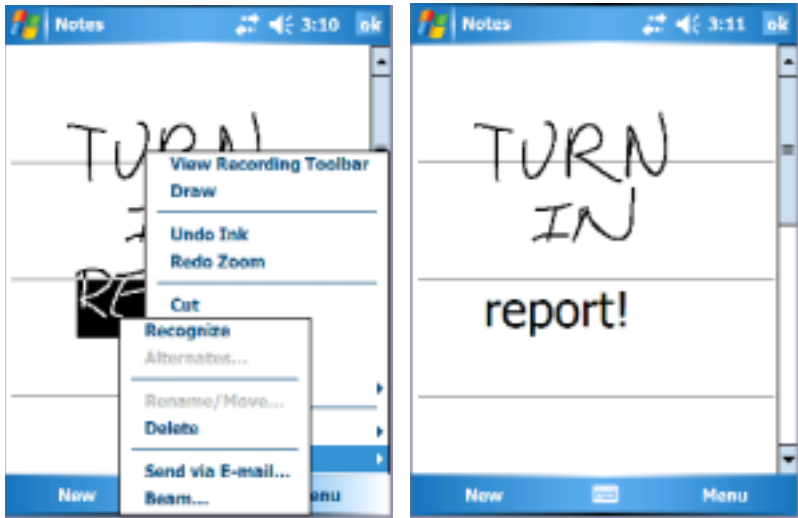

If you want to convert only certain words, select them before tapping **Recognize** (or tap and hold the selected words and then tap **Recognize** on the pop-up menu). If a word is not recognized, it is not converted to print-style text.

If the conversion is incorrect, you can select different words from a list of alternatives or return to the original written text:

- 1 Tap and hold the incorrect word.
- 2 On the pop-up menu, tap **Alternates**.
A menu with a list of alternative words appears.
- 3 Tap the correct word, or tap the written text at the top of the menu to return to the original written text.

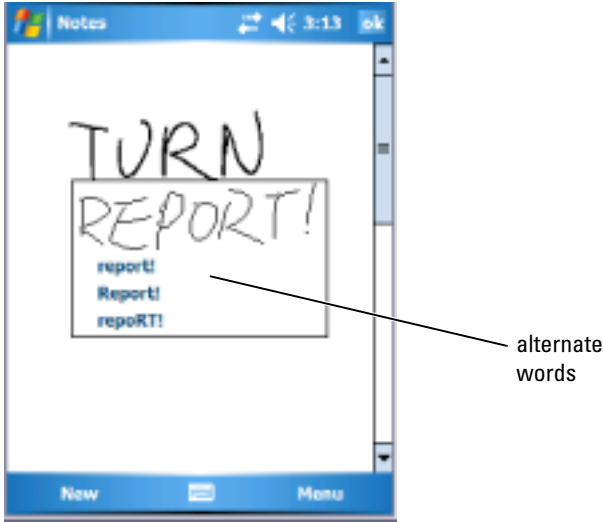

Tips for getting good recognition:

- Write neatly.
- Write on the lines and draw descenders below the line. Write the cross of the "t" and apostrophes below the top line so that they are not confused with the word above. Write periods and commas above the line.
- For better recognition, try changing the zoom level to 300 percent by tapping **Menu** → **Zoom**.
- Write the letters of a word closely and leave big gaps between words so that the device can easily determine where words begin and end.
- You cannot convert hyphenated words, foreign words that use special characters such as accents, and some punctuation.
- You cannot add written text to a word to change it after the word has been recognized. You must delete the written word and write the new word.

Drawing on the Screen

You can draw on the screen the same way that you write on the screen. However, selecting and editing drawings is different than selecting and editing written text. For example, selected drawings can be resized, while written text cannot.

Creating a Drawing

 **NOTE:** To zoom in or out on your drawing, tap **Menu** → **Zoom** and tap a zoom level.

Cross three ruled lines on your first stroke. A drawing box appears. Subsequent strokes that touch or are inside of the drawing box become part of the drawing. Drawings that do not cross three ruled lines are treated as written text.

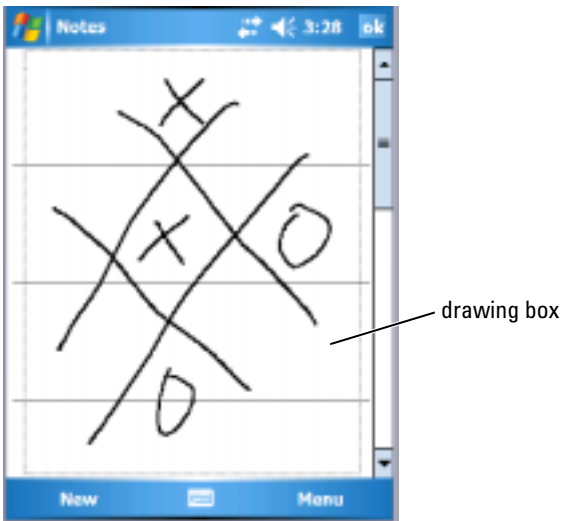

Editing a Drawing

To edit or format a drawing, you must first select it:

- 1 Tap and hold the stylus on the drawing until the selection handles appear.
To select multiple drawings, drag to select the drawings.
- 2 You can cut, copy, and paste selected drawings by tapping and holding the selected drawings and then tapping an editing command on the pop-up menu.
You can also tap **Menu** → **Edit** at the bottom of the screen to select editing commands.

To resize a drawing, drag a selection handle.

Recording a Message

In any program where you can write or draw on the screen, you can also quickly capture thoughts, reminders, and phone numbers by recording a message.

- In Calendar, Tasks, and Contacts, you can include a recording in the **Notes** tab.
- In the Notes program, you can either create a stand-alone recording or include a recording in a written note. If you want to include the recording in a note, open the note first.
- In the Messaging program, you can add a recording to an e-mail message.

To record a message:

- 1 Hold the microphone near your mouth or other source of sound.
- 2 Press and hold the **Record** button on the side of your device until it beeps.
- 3 While holding down the **Record** button, make your recording.
- 4 To stop recording, release the **Record** button.

The device beeps twice. The new recording appears in the note list or as an embedded icon.



NOTE: You can also make a recording by tapping the **Record** icon on the Recording toolbar.

To play a recording, tap the name of the recording in the list or tap the speaker icon in the note.

Using My Text

When using Messaging or MSN Messenger, use **My Text** to quickly insert preset or frequently used messages. To insert a message, tap **Menu** → **My Text** and tap a message.

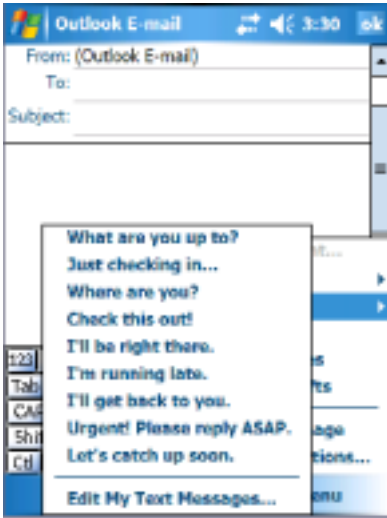

 **NOTE:** You can add text to a **My Text** message after you insert the message.

To edit a **My Text** message:

- 1 Tap **Menu** → **My Text** → **Edit My Text Messages**.
- 2 Make the changes and tap **OK**.

Adjusting Settings

You can adjust the device settings to suit the way you work. To see available options, tap **Start** → **Settings**.

 **NOTE:** Depending on the features of your device, you might have additional tabs and additional items on the tabs.

See your device **Help** for additional information on adjusting settings (tap **Start** → **Help**).

Personal Tab

- **Buttons** — Assign the programs that launch when you press the device buttons.
- **Input** — Adjust the settings for input method, word completion, and other options.
- **Menus** — Add or remove items from the **Start** menu.
- **Owner Information** — Enter your contact information.
- **Password** — Set a password to protect the data stored on your device.
- **Sounds & Notification** — Adjust the volume and set notifications. See "Notifications" on page 98 for more information.
- **Today** — Customize the look and the information that is displayed on the Today screen.
- **MSN Options** — Settings you can use to create a custom Pocket MSN experience.

System Tab

- **About** — Find information about Windows Mobile 5.0 and your device.
- **Brightness** — Adjust the brightness settings to conserve power.
- **Certificates** — View or delete certificates stored on your device. Certificates help establish your identity and the identity of other computers to prevent unauthorized users from accessing your data.
- **Clock & Alarms** — Change the time and set the alarm.
- **Memory** — Allocate memory for data and program storage. View free and used memory, storage card memory, and running programs.
- **Error Reporting** — Send information needed by technical support groups to diagnose a program error for a device running Windows Mobile software. For this your device must be connected to the Internet.
- **GPS** — Configure the settings when you have a GPS device connected to understand the exact location you are in, with the help of the maps. Note that your Axim does not have a built-in GPS device.

- **Mirror Mode** — This is available only in the X50v model. Mirror mode allows users to see the same image on both the PDA screen and on an external display using a VGA cable. When enabled, an icon will be displayed on the command bar. To disable mirror mode, click on the icon or clear the checkbox.
- **Microphone** — Adjust the microphone volume.
- **Power** — Check the battery or charge status. Use the **Advanced** tab to set the amount of time that the device can remain idle before it turns off.
- **Regional Settings** — View and change the formatting for regional settings such as currency, time, and date.
- **Remove Programs** — Remove programs from your device. For more information, see "Adding and Removing Programs" on page 115.
- **Screen** — Adjust the screen if your device is not responding accurately to taps, and select the screen orientation that you want to use.
- **Switcher Bar** — Adjust the settings of the Switcher Bar program launcher utility.
- **System Information** — View technical information about your device.

Connections Tab

- **Beam** — Receive infrared beams from other devices.
- **Bluetooth** — Turn on and off the radio with Bluetooth® wireless technology, and create and edit bonded devices. By default, the radio is off.
- **Connections** — Add and configure modem and server connections.
- **Dell WLAN Utility** — Available only on devices with internal Wi-Fi. Use the WLAN utility to connect to the wireless network using EAP/TTLS.
- **Network Cards** — Configure your network adapter settings.
- **Odyssey Client** — Provides secure authentication and connection of wireless LAN (WLAN). This is available for Mid and Hi end Axim versions only.

Communicating and Scheduling

About Microsoft® ActiveSync® Program

Microsoft ActiveSync 4.0 is the latest synchronization software for the Axim. ActiveSync transfers files and data between your device and a computer. It can upload drivers and programs to the device. ActiveSync should be installed before connecting the device to a computer. You can find the ActiveSync installation program on the Dell *Getting Started* CD.

You can synchronize the information on your computer with the information on your device using ActiveSync. This compares the data on your device with the data on your computer and updates both with the most recent information. For example:

- Keep Microsoft Pocket Outlook data up-to-date by synchronizing your device with Microsoft Outlook data on your computer.
- Synchronize Microsoft Word and Microsoft Excel files between your device and your computer. Your files are automatically converted to the correct format.





NOTE: By default, ActiveSync does not automatically synchronize all types of information. You can change ActiveSync options to synchronize specific types of information.

With ActiveSync, you can also:

- Copy (rather than synchronize) files between your device and your computer.
- Select a mode to control when synchronization occurs. For example, you can synchronize continuously or only when you select the synchronize command.
- Select which information types are synchronized and control how much data is synchronized. For example, you can choose how many weeks of past appointments you want synchronized.

To synchronize your data, you need both the Microsoft Windows® and Pocket PC versions of ActiveSync. You must install the Windows version of ActiveSync on your computer using the Dell™ *Getting Started* CD. The Pocket PC version is already installed on your device.

 **NOTE:** Before connecting your device to a computer for the first time, ensure that you install ActiveSync on the computer using the *Dell™ Getting Started CD*.

 **NOTE:** If your Axim fails to synchronize, check your computer security software to see if you have any firewall running. Firewalls may block the communication from your computer to your Axim.

Installing and Using ActiveSync

To install ActiveSync:

- 1 Insert the Dell *Getting Started* CD.
- 2 Click **Getting Started** to access the main menu.
- 3 Click **Start Here**.
- 4 Click **Install ActiveSync** and follow the instructions on the screen.

After the installation is complete, connect your device to your computer.

The **ActiveSync Setup Wizard** enables you to:

- Set up a partnership so that you can synchronize information between your device and your computer
- Customize your synchronization settings

Your first synchronization process automatically begins when you complete the wizard.

 **NOTE:** The device must be powered on for the synchronization process to occur.

During your first synchronization, information that was stored in Outlook on your computer is copied to Calendar, Contacts, and Tasks on your device.

After you set up ActiveSync and complete the first synchronization process, you can initiate synchronization from your device. To switch to ActiveSync on your device, tap **Start** → **ActiveSync**.

To find information on using ActiveSync on your device, open ActiveSync on your device and tap **Start** → **Help**.

To find information on using ActiveSync on your computer, click **Help** → **Microsoft ActiveSync Help**.

About Microsoft® Pocket Outlook

Pocket Outlook includes Calendar, Contacts, Tasks, Messaging, and Notes. You can use these programs individually or together. For example, e-mail addresses stored in Contacts can be used to address e-mail messages in Messaging.

 **NOTE:** Pocket Outlook is pre-installed on your device. If not already installed, your Dell *Getting Started* CD has a copy of the Pocket Outlook installation program. Ensure that you install Pocket Outlook and not Outlook Express. Note that you can only install Pocket Outlook once, as it is a licensed version.

Using Microsoft ActiveSync®, you can synchronize information on your computer in Microsoft Outlook or Microsoft Exchange. You can also synchronize this information directly with an Exchange server. Each time you synchronize, ActiveSync compares the changes you made on your device and computer or server and updates both with the latest information. For information on using ActiveSync, see ActiveSync Help on your computer.

You can switch to any of the following programs through the **Start** menu.

 **NOTE:** For detailed information about Calendar, Contacts, Tasks, Messaging, and Notes, among other things, see Help on your device.

Categories

Use categories to group related contacts, tasks, and appointments. For example, you can assign work-related contacts to the Business category and personal contacts to the Personal category so that you can quickly find contact information. You can also create your own categories, such as Family, to group your relatives' contact information.

Creating a Category

To create a category:

- 1 From the program, tap an existing item or create a new one.
- 2 For a new item in Calendar, Contacts, and Tasks, tap **Categories**.
- 3 Tap **New**, enter the category name, and tap **Done**.
The new category is automatically assigned to the item.

- 4 For an existing item in Calendar and Tasks, tap **Edit** → **Categories**.
- 5 For an existing item in Contacts, tap **Menu** → **Edit** → **Categories**.
- 6 Tap **OK** to return to the appointment, contact, or task.

Calendar

Use Calendar to schedule appointments, including meetings and other events. You can check your appointments in one of several views (Agenda, Day, Week, Month, and Year) and easily switch views by using the view menu. Tap the **Today** icon to view the current date.

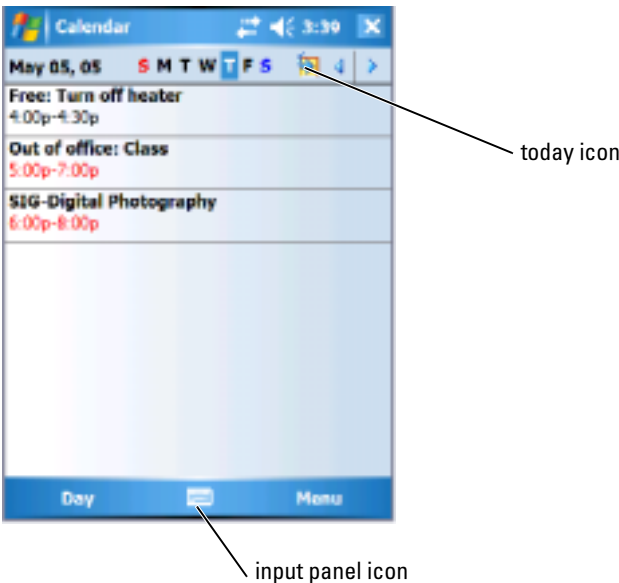

NOTE: To customize Calendar, such as changing the first day of the week, tap **Menu** and tap **Options**.

To create an appointment:

- 1 Tap **Start** → **Calendar**.
- 2 Tap **Menu** → **New Appointment**.
- 3 Enter a name for the appointment, and enter information such as start and end times.

- 4 To schedule an all-day event, in the **All Day** box, tap **Yes**.
- 5 When finished, tap **OK** to return to the calendar.

To receive a reminder for an appointment:

- 1 Tap **Start** → **Calendar** → **Menu** → **Options** → **Appointments** tab.
- 2 Select the **Set reminders for new items** check box.
- 3 Set the time when you want the reminder to alert you.
- 4 Tap **OK** to return to the calendar.

Using the Summary Screen

When you tap an appointment in Calendar, a summary screen appears. To change the appointment, tap **Edit**.

Creating Meeting Requests

You can use Calendar to set up meetings with users of Outlook or Pocket Outlook. The meeting request is automatically created when you synchronize Messaging or when you connect to your e-mail server. To set how you want meeting requests sent, tap **Menu** and tap **Options**.

To schedule a meeting:

- 1 Tap **Start** → **Calendar**.
- 2 Schedule a new appointment, or open an existing one and tap **Edit**.
- 3 Tap **Attendees**.
- 4 Tap the name of the contact you want to invite.
- 5 To invite each additional attendee, tap **Add** and tap the name.
- 6 Tap **OK**.

The meeting request will be sent to the attendees the next time you synchronize your device with your PC.

For more information on sending and receiving meeting requests, tap **Start** → **Help** → **Calendar** or **Messaging**.

Contacts

Use Contacts to maintain a list of your friends and colleagues. You can quickly share Contacts information with other device users using the infrared port.

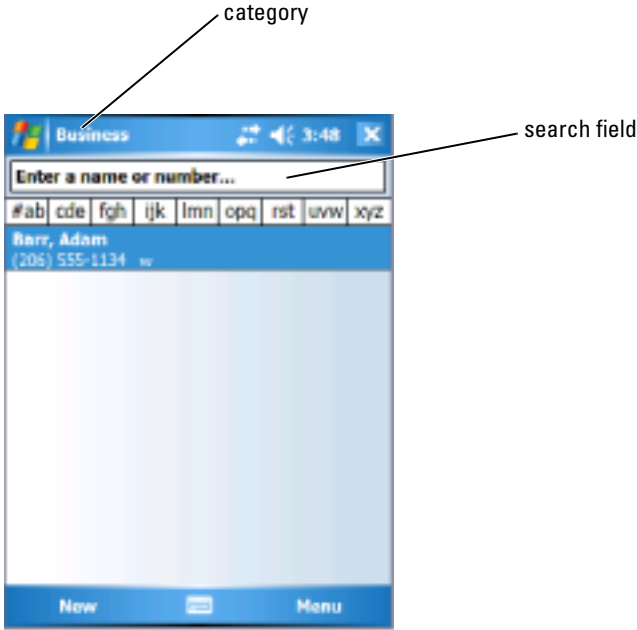

 **NOTE:** To change the way information is displayed in the list, tap **Menu** → **Options**.

To create a contact:

- 1 Tap **Start** → **Contacts** → **New**.
- 2 Using the input panel, enter a name and other contact information. Scroll down to see all available fields.
- 3 To assign the contact to a category, tap **Categories** and select a category from the list.

In the contact list, you can display contacts by category.

- 4 To add notes, tap the **Notes** tab. You can enter text, draw, or create a recording. For more information on creating notes, see "Notes" on page 93.
- 5 When you have finished entering information, tap **OK** to return to the calendar.

Finding a Contact

To find a contact:

- 1 Tap **Start** → **Contacts**.
- 2 If you are not in Name view, tap **Menu** → **View By** → **Name**.
- 3 Do one of the following:
 - Begin entering a name or phone number in the provided text box until the contact you want is displayed. To show all contacts again, tap the text box and clear the text, or tap the arrow to the right of the text box.
 - Use the alphabetical index displayed at the top of the contact list.
 - Filter the list by categories. In the contact list, tap **Menu** → **Filter**. Then tap a category you have assigned to a contact. To show all contacts again, select **All Contacts**.
- 4 To view the names of companies your contacts work for, tap **View** in the contact list and tap **By Company**. The number of contacts that work for that company is displayed to the right of the company name.

Using the Summary Screen

When you tap a contact in the contact list, a summary screen appears. To change the contact information, tap **Edit**.

Tasks

 **NOTE:** To change the way information is displayed in the list, tap **Menu** → **Options**.

Use Tasks to list things that you need to do.



sort menu

To create a task:

- 1 Tap **Start** → **Programs** → **Tasks**.
- 2 Tap **New**, enter a subject for the task, and fill in information such as start and due dates.
- 3 When finished, tap **OK**.
- 4 To copy an existing task from the task list, select the task you want to copy. Tap **Menu** → **Edit** → **Copy**, and then tap **Menu** → **Edit** → **Paste**.
- 5 To add notes, tap the **Notes** tab. You can enter text, draw, or create a recording. For more information on creating notes, see "Notes" on page 93.

 **NOTE:** To quickly create a task with only a subject, tap **Menu** → **Options** → **Show Tasks entry bar**. Tap the **Tap here to add a new task**, and enter your task information.

Notes

Quickly capture thoughts, reminders, ideas, drawings, and phone numbers with Notes. You can create a written note or a recording. You can also include a recording in a note. If a note is open when you create the recording, it is included in the note as an icon. If a note is not open, the recording is saved as a stand-alone recording.



To create a note:

- 1 Tap **Start** → **Programs** → **Notes** → **New**.
- 2 Create your note by writing, drawing, typing, or recording. For more information on using the input panel, writing and drawing on the screen, and creating recordings, see "Entering Information" on page 72.

Messaging

Use Messaging to send and receive e-mail messages:

- Synchronize e-mail messages using Exchange or Outlook on your computer.
- Send and receive e-mail messages by connecting directly to an e-mail server through an ISP or a network.



NOTE: To create an e-mail account for your device, contact your internet service provider. Dell does not provide this service.

Synchronizing E-Mail Messages

You can synchronize e-mail messages along with the rest of your data if you enable Messaging synchronization in ActiveSync. For information on enabling Messaging synchronization, see ActiveSync Help on your computer.



NOTE: You can also synchronize e-mail messages with your computer from a remote location. For more information, see "Getting Connected" on page 101.

During synchronization:

- Messages are copied from the e-mail folders of Exchange or Outlook on your computer to the ActiveSync folder in Messaging on your device. By default, you receive:
 - Messages from the past 3 days
 - The first 100 lines of each message
 - File attachments of less than 100 KB in size
- E-mail messages in the **Outbox** folder on your device are transferred to Exchange or Outlook on your computer, and then sent from those programs.
- E-mail messages in subfolders on your computer must be selected in ActiveSync to be transferred.

Connecting Directly to an E-Mail Server

In addition to synchronizing e-mail messages with your computer, you can send and receive e-mail messages by connecting to an e-mail server using a modem or network card connected to your device. You need to set up a remote connection to a network or an ISP, and a connection to your e-mail server. For more information, see "Getting Connected" on page 101.

When you connect to the e-mail server:

- New messages are downloaded to the device **Inbox** folder.
- Messages in the device **Outbox** folder are sent.
- Messages that have been deleted on the e-mail server are removed from the device **Inbox** folder.

Messages that you receive directly from an e-mail server are linked to your e-mail server rather than to your computer. When you delete a message on your device, it is also deleted from the e-mail server the next time you connect, depending on the settings you selected in ActiveSync.

When you are working online, you read and respond to messages while connected to the e-mail server. Messages are sent as soon as you tap **Send**, which saves space on your device.

After you have downloaded new message headers or partial messages, you can disconnect from the e-mail server and then decide which messages to download completely. The next time you connect, Messaging downloads the messages you have marked for retrieval and sends the messages you have composed.

Using the Message List

Messages you receive are displayed in the message list. By default, the most recently received messages are displayed first in the list.

When you receive a message, tap to open it. Unread messages are displayed in bold.

The original messages remain on the e-mail server or your computer. You can mark the messages that you want to retrieve in full during your next synchronization or e-mail server connection. In the message list, tap and hold the message that you want to retrieve. On the pop-up menu, tap **Mark for Download**. The icons in the Inbox message list indicate message status.

You specify your downloading preferences when you set up the service or select your synchronization options. You can change the settings at any time:

- Change options for Messaging synchronization using ActiveSync options. For more information, see ActiveSync Help on your computer.
- Change options for direct e-mail server connections in Messaging on your device. Tap **Menu** → **Options**. On the **Account** tab, tap the service that you want to change. Tap and hold the service and select **Delete** to remove a service.

Composing Messages

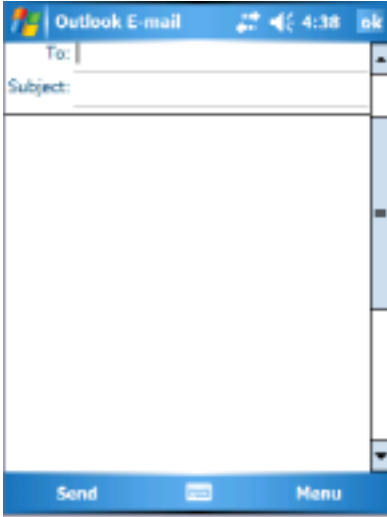

To compose and send a message:

- 1 In the message list, tap **Menu** → **Switch Accounts** and select the account.
- 2 Tap **New**.
- 3 Enter the e-mail address of one or more recipients, separating them with a semicolon. To access addresses and phone numbers from Contacts, tap **To**.
- 4 Enter your message. To quickly add common messages, tap **Menu** → **My Text** and tap a desired message.
- 5 To check the spelling, tap **Menu** → **Spell Check**.
- 6 Tap **Send**.

If you are working offline, the message is moved to the **Outbox** folder and sent the next time you connect to the network.

Managing E-Mail Messages and Folders

By default, messages are displayed in one of the five folders for each service you have created: **Inbox**, **Deleted Items**, **Drafts**, **Outbox**, or **Sent Items**.

The **Deleted Items** folder contains messages that have been deleted on the device. The behavior of the **Deleted Items** and **Sent Items** folders depends on the options you have selected. To change the options, tap **Menu** → **Tools** in the message list and tap **Options**. On the **Message** tab, select your options.

To create, rename, or delete a folder, tap **Menu** → **Tools** → **Manage Folders**.

To move a message to another folder, tap and hold the message in the message list and tap **Move to** on the pop-up menu.

Folder Behavior With a Direct Connection to an E-Mail Server

The behavior of the folders you create depends on whether you use ActiveSync, POP3, or IMAP4.

- *If you use ActiveSync*, e-mail messages in the **Inbox** folder in Outlook are automatically synchronized with your device. You can synchronize additional folders by designating them for ActiveSync. The folders you create and the messages you move are then mirrored on the server. For example, if you move messages from the **Inbox** folder to a folder named **Family**, and you have designated **Family** for synchronization, the server creates a copy of the **Family** folder and copies the messages into that folder. You can then read the messages while away from your computer.
- *If you use POP3* and you move e-mail messages to a folder you created, the link is broken between the messages on the device and their copies on the e-mail server. The next time you connect, the e-mail server detects that the messages are missing from the device **Inbox** and deletes them from the server. This prevents you from having duplicate copies of a message. However, you can access these folder contents from the device only.
- *If you use IMAP4*, the folders you create and the e-mail messages you move are mirrored on the server. Therefore, messages are available to you any time you connect to your e-mail server, whether it is from your device or computer. This synchronization of folders occurs whenever you connect to the server, create new folders, rename, or delete folders when connected.

Notifications

You can set your device to remind you when you have something to do. For example, if you have set up an appointment in Calendar, a task with a due date in Tasks, or an alarm in Clock, you are notified in one of the following ways:

- A message box appears on the screen
- A sound, which you can specify, plays
- A light flashes on your device

To configure the reminders and sounds for your device:

- 1 Tap **Start** → **Settings**.
- 2 On the **Personal** tab, tap **Sounds & Notifications**.
 - **Sounds** tab — Adjust the volume and enable sounds
 - **Notifications** tab — Set notifications for specific events

Beaming an Item

In the Calendar, Contacts, Notes, Tasks, Excel Mobile, Word Mobile, PowerPoint Mobile, and Pictures programs, you can beam files and information to other devices using Bluetooth or infrared.

- 1 From the program, select the item you want to beam, such as an appointment in Calendar, a task in Tasks, a contact card in Contacts, or a file in File Manager.
- 2 Tap **Menu** → **Beam** [type of item].
- 3 Do one of the following:
 - If using Bluetooth, tap the device to which you want to send the item.
 - If using infrared, align the infrared (IR) ports at close range until the target device name appears, and then tap the device to which you want to send the item.

Using File Explorer

File Explorer lets you browse the folders contents on your device. The root folder is called My Device. My Device is similar to My Computer on the computer and contains My Documents, Program Files, Temp, Storage Card, and Windows folders among others.

To find an item:

- 1** Tap **Programs** → **File Explorer**.
The **My Documents** folder and its subfolders appear.
- 2** Tap the folder list (labeled **My Documents** by default) and tap the folder you want to explore.
- 3** To open an item, tap it.
- 4** To quickly delete, rename, or copy an item, tap and hold the item.
- 5** To select multiple items, tap and drag. Then, tap and hold the selected items, and tap a command.

Getting Connected

You can use your device to exchange information with other mobile devices or with a computer, a network, or the Internet. You can use any of the following connection options:

- Use the infrared (IR) port on your device to send and receive files between two devices. See the following section, "Using Infrared," for more information.
- Connect to your Internet Service Provider (ISP). Once you are connected, you can send and receive e-mail messages using Messaging, and view Web or WAP pages using Internet Explorer Mobile. The communication software for creating an ISP connection is already installed on your device. Your service provider provides the software needed to install other services, such as paging and fax services.
- Connect to the network at the company or organization where you work. Once connected, you can send and receive e-mail messages using Messaging, view Web or WAP pages using Internet Explorer Mobile, and synchronize with your computer.
- Connect to your computer to synchronize remotely. Once you are connected, you can synchronize information such as your Pocket Outlook information. See Microsoft ActiveSync® Help on your computer or Connections Help on the device for more information.

Using Wi-Fi (802.11b)

Wi-Fi provides your device access to WLAN (Wireless Local Area Network.) Short for wireless fidelity, Wi-Fi refers to any type of 802.11 network, whether 802.11b, 802.11a, or dual-band. Wi-Fi certified products from different manufacturers are interoperable.



NOTE: Mid and High configurations of the Axim have Wi-Fi 802.11b built in and the drivers factory installed. For a Low configuration device, you must purchase the 802.11b SD card, insert it in your device, and load the drivers.



NOTE: The default Wireless Networking Client utility for your device is the Dell WLAN utility. The following configuration steps are for the Dell WLAN utility.

Configure wireless networking for your device in one of the following scenarios:

- Network Card is set up
- Wireless Network is broadcasting SSID
- Wireless Network is not broadcasting SSID

If the Network Card is Set Up

Normally the internal wireless card is already set up. There are times when you must choose the network card. On the Axim X50/X50v configurations that have built-in wireless, the network card is associated with the enabled wireless. If wireless is not enabled or you are using a socket card for wireless connection, then choose the network card:

- 1 Tap **Start** → **Settings** → **Connections**.
- 2 Tap **Network Cards**.
- 3 Choose either **Internet** or **Work** from the menu.
- 4 Choose the network card to connect to the network. For the Axim X50/X50v with built-in wireless, choose **Dell Axim X50/X50v WLAN Wireless Adapter**.
- 5 Choose whether the network card assigns an IP address or receives an IP address automatically.
- 6 Enter the Server IP addresses if required and tap **OK**.

If the Wireless Network is Broadcasting SSID

- 1 Press the wireless button to enable wireless capability. The green LED in the right top corner of the device indicates that the wireless is functional.
- 2 Tap **Start** → **Settings** → **Connections**.
- 3 To add, edit, or delete a profile, select the corresponding action tap **Network Cards**.
- 4 In the **Configure Wireless Networks** window, select one of the available network names and tap **OK**.

If the Wireless Network is Not Broadcasting SSID

The **Configure Wireless Networks** window only shows wireless networks that broadcast a Network Name (SSID) and those that have been added. Add the network if it is not listed. Contact your network administrator for the following information:

- SSID (network name)
- Authentication
- Data Encryption
- Keys (if the key is not provided automatically)
- Log in if necessary

To configure the wireless network:

- 1** From the **Configure Wireless Networks** window, tap **Add New**.
- 2** Provide the Network Name (SSID).
- 3** Select either **Internet** or **Work** in the **Connects To** box.
 - Selecting **Internet** allows you to connect to your network but you will have to manually start a VPN connection, if needed.
 - Selecting **Work** automatically starts a VPN connection any time you connect to the network.
 - If you are having trouble connecting to your network, change the **Connects To** box to **Internet**.
- 4** Tap the **Network Key** tab.
- 5** Enter the **Authentication** and **Data Encryption** information. If a key is required, enter the network key.
- 6** Select the **802.1x** tab.
- 7** The Authentication and Data Encryption chosen on the previous screen determines whether this screen is available. If available choose the **EAP type** used on the network.
- 8** Tap **OK**.
- 9** If more than one network is listed, tap and hold the stylus on the network name you want to connect to. A pop-up menu appears. Tap **Connect**. After a few seconds you should see **Connected** next to the wireless network you selected.

Using Odyssey Client

Odyssey is a wireless LAN access control and security solution that provides strong security over the wireless link. It secures authentication and connection of wireless LAN (WLAN) users, ensuring that only authorized users can connect.

Odyssey is mostly used in place of a manufacturer's wireless networking client such as the Dell WLAN utility, Intel ProSET, or Windows XP's Zero Config Service.

To use Odyssey:

- Tap **Start** → **Settings** → **Connections Tab** → **Odyssey Client**.
The main page appears with the following information:
 - Status of Odyssey
 - Network Name (SSID)
 - Access Point MAC
 - Packet information
- To enable the Odyssey Client tap **Settings** → **Enable Odyssey**.
- To configure a wireless profile, tap **Settings** → **Configure**. This provides you a list of existing profiles and allows you to add, edit, or delete profiles.

Adding a Network

To add a new profile:

- 1 Tap **Settings** → **Configure** → **Add**.
The **Add Network Wizard** window appears.
- 2 Enter the network name, or select the box **Any** if you want the client to connect to any available network.
- 3 Tap **Scan** to view all available broadcasted networks.
Enter a description if necessary.
- 4 Select between an ad-hoc or infrastructure network.
- 5 Tap **Next** when ready.

- 6** Enter security settings:
 - **Association Mode** allows for open, shared, or WPA association methods.
 - **Encryption Method** changes based on what mode is chosen. Options include none, WEP, and TKIP.
 - If 802.1x is used, check the box **Authenticate using 802.1X**.
 - For WPA-PSK, enter your **Passphrase** (key).
- 7** Depending on your selections, the next page appears. You could be asked to enter a WEP key or username and password.
- 8** Tap **Next**.
- 9** Here you can select EAP (Extensible Authentication Protocol) methods. Default settings only include EAP / TTLS.
 - a** If you need other EAP methods, tap **Add**.
 - b** After adding other EAP methods, tap **OK**.
 - c** Tap **Next**.
- 10** Enter an anonymous name to keep your login name private. This name will be used for outer visible authentication. Tap **Next**.
- 11** Depending on the EAP method you chose, select an inner authentication protocol. Tap **Next**.
- 12** Enter username and password and tap **Next**.
- 13** Tap **Finish**.
- 14** When done, the new profile is added to the networks to choose from. To select a profile to connect to, tap **OK** in the upper right corner.
- 15** When you return to the **Today** page, there will be a new icon in the systems tray for Odyssey.

Using Cisco® LEAP Wireless LAN Security

Your Dell Axim X50 supports 802.1x network authentication between the client and server with a logon password using Cisco LEAP.

Cisco LEAP can be configured using the Odyssey Client application.



NOTE: Before starting, ensure that the Wireless power is enabled using the Wireless On/Off button.



NOTE: LEAP is not supported on a peer-to-peer network. LEAP is not supported on a low configuration Axim X50.

To start Odyssey Client:

- 1 Tap **Start** → **Settings** → **Connections** → **Odyssey Client** icon.
- 2 Tap **Settings** → **Enable Odyssey**.

To start using LEAP:

- 1 Obtain the following information from your network administrator:
 - Network name
 - Association mode
 - Encryption method
- 2 From the **Odyssey Client** window, tap **Settings** → **Configure** → **Add**.
- 3 Enter the network name (SSID) if known, or tap **Scan** to search for available Access Points. Tap **Next**.
- 4 LEAP will only support an infrastructure network, so do not change the default settings in the drop-down menu. Tap **Next**.
- 5 Fill in the **Association Mode** and **Encryption** method. Tap **Next**.
- 6 **EAP/TTLS** is the default EAP type. Tap **Add** and select **EAP/LEAP** in the window that opens up.

Unless you have an authentication certificate to use TTLS and have configured your system to support it, remove **EAP/TTLS**.



NOTE: Failure to remove EAP/TTLS when it is not properly set up may prevent your wireless security system from functioning.

- 7 Tap **Next**.
- 8 Enter your user name and password. Tap **Next**.
- 9 Tap **Finish** to complete LEAP configuration.

- 10 Tap OK.
- 11 Select the network that you added from the drop-down menu and tap the box beside **Connect to**. The status displays as connected (authenticated) when this process is complete.

 **NOTE:** For further details, please refer to the Odyssey Client help file included in your device. You can access the help file at **Start → Help → Odyssey Client for Pocket PC** or tap **Help** from the **Odyssey Client** main screen.

Using Odyssey Client to a Get Certificate of Authority

There are two ways to get certification in Odyssey client:

- Certificate Enroller
- Import User Certificate

Use the Certificate Enroller to install a user certificate using Microsoft Certificate Services. Use Import User Certificate to install the **.pfx** certificate file stored in the device. To decide the certificate type ask your network administrator.

To use the Certificate Enroller:

- 1 Using the Odyssey client, connect to a non 802.1x enabled wireless network on which the certificate server is located.
- 2 Tap **Start → Settings → Connections → Odyssey Client**.
- 3 Tap **Tools → Certificate Enroller**.
- 4 Enter the IP address of the certificate server in the **Server** field.
- 5 Enter the user name and the domain name in the **User name** field using the following rule:
Domain-name\User-name
- 6 Tap **Request**.

To use the Import User Certificate:

 **NOTE:** Before you install a certificate, you must know its RSA-type private key password.

- 1 Tap **Start → Settings → Connections → Odyssey Client**.
- 2 Tap **Tools → Import User Certificate**.

- 3 Tap **Browse** to navigate to a **.pfx** file you have stored on your device. Select the file, and tap **OK**.
- 4 Type in the RSA-type private key password for this certificate under **Private key password**. You can optionally click **Unmask** to make this password visible while you type it.
- 5 Tap **Install Certificate** when you are done.

Using Infrared

Infrared is used to send and receive information remotely, such as contacts and appointments, between two devices.

To send information:

- 1 Switch to the program where you created the item you want to send and locate the item in the list.
- 2 Align the infrared sensors so that they are unobstructed and within close range.
- 3 Tap and hold the item, and tap **Beam xxxx** on the pop-up menu, where **xxxx** is the item you want to beam.

You can also send items (excluding folders) from File Explorer. Tap and hold the item you want to send, and tap **Beam File** on the pop-up menu.

Using Bluetooth® Wireless Technology

Bluetooth is a wireless technology aimed at simplifying communications between devices and the Internet. It is an open specification for short-range communication of data and voice. For example, it can synchronize data between hand-held devices and other computers.

To configure a device with Bluetooth wireless technology in a Pocket PC environment:

- 1 Ensure that the two devices are turned on, discoverable, and within close range.
- 2 Tap **Start** → **Settings** → **Connections** tab.
- 3 Tap **Bluetooth** → **Devices** tab → **New Partnership**. Your device searches for other Bluetooth devices and displays them in the list.
- 4 Tap the name of the other device, and tap **Next**.

- 5 In the Passkey field, if you want to use a passkey (recommended for enhanced security), enter a alphanumeric passkey between 1 and 16 characters, and tap **Next**. Otherwise, leave Passkey blank, and tap **Next**.



NOTE: The Passkey for a remote Bluetooth device is usually found in the user manual for that device. The default Passkey for any Dell Axim is 1234.

- 6 Enter the same passkey for the other device.
- 7 Tap **Finish**.

An active connection with Bluetooth wireless technology is created and pairing of the two devices is complete.



NOTE: For more information about using Bluetooth wireless technology, tap **Start** → **Help** → **Setting Up Connections**.

Creating a Modem Connection

To create a modem connection:

- 1 Install a modem card and appropriate adapters to connect an external modem to your device through the serial port.
- 2 Obtain the following information from your ISP:
 - ISP dial-up access telephone number
 - Username and password
 - TCP/IP settings

Some ISPs require information in front of the username, for example, *MSN/username*.

- 3 Tap **Start** → **Settings** → **Connections** tab → **Connections**.
- 4 Under **My ISP** or **My Work Network**, tap **Add a new modem connection**.
- 5 Enter a name for the connection, such as **ISP Connection**.
- 6 From the **Select a modem** list, select your modem type, and tap **Next**.

If your modem type does not appear, try reinserting the modem card. If you are using an external modem connected to your device with a cable, select **Hayes Compatible on COM1**. See your modem user guide for details.

- 7 Enter the phone number just the way you would dial it. If you need an area code, be sure to include it. Tap **Next**.
 - 8 Enter your user name, password, and, if applicable, your domain. This information is provided by your ISP or network administrator.
-  **NOTE:** You should not need to change any settings in **Advanced**. Most ISPs now use a dynamically assigned address.
- 9 If the ISP you are connecting to does not use a dynamically assigned address, tap **Advanced**, tap the **TCP/IP** tab, and then enter the address.
 - 10 Tap **OK**.
 - 11 Select other required options and tap **Finish**.

When you open Messaging, Internet Explorer Mobile, or MSN Messenger, your device automatically connects. Once you are connected, you can:

- Send and receive e-mail messages using Messaging. Before you can use Messaging, you need to provide the information that Messaging needs to communicate with the e-mail server. See "Connecting Directly to an E-Mail Server" on page 112 for more information.
- See Web and WAP pages using Internet Explorer Mobile. For more information, see "Using Internet Explorer Mobile" on page 126.
- Send and receive instant messages with MSN Messenger. For more information, see "MSN Messenger" on page 124.

Creating an Ethernet Connection

The term Ethernet refers to the family of LAN products covered by the IEEE 802.3 standard. It defines what is commonly known as the CSMA/CD protocol.

To create an ethernet connection:

- 1 Contact your network administrator to obtain a user name, password, and domain name.
- 2 Install the network card driver, if required. For more information, see the documentation that came with your network card.

- 3 The **Network Settings** window appears automatically the first time you insert the network card, so that you can configure the network card. To change settings later, tap **Start** → **Settings** → **Connections** tab → **Connections**.
- 4 If you need to enter specific server information, tap the appropriate adapter, and then tap **Properties**. You may need to enter proxy server and VPN connection settings. For more information, see your network administrator.
 **NOTE:** Most networks use DHCP (Dynamic Host Configuration Protocol), so you do not need to change the connection settings unless your network administrator instructs you to do so.
- 5 If necessary, connect the network card to the network with a network cable. For more information, see the documentation that came with your network card.

Creating a VPN Connection

A Virtual Private Network (VPN) is constructed using public wires to connect nodes. These systems use encryption and other security mechanisms to ensure that only authorized users can access the network and that data cannot be intercepted.

- 1 Tap **Start** → **Settings** → **Connections** tab → **Connections**.
- 2 Tap **Add a new VPN server connection**.
 **NOTE:** If you have already created a VPN Server, tap **Edit My VPN Servers** then tap **New**.
- 3 Enter a name for the connection.
- 4 In the **Host name/IP** field, enter the VPN server name or IP address. Your network administrator provides you this information.
- 5 Depending on the type of authentication that you want to use with your device, tap **IPSec** or **PPTP** next to **VPN type**.
If you are unsure about which option to select, contact your network administrator.
- 6 Tap **Next** and enter your username, password, and, if required, domain.
- 7 Install the network card driver, if required. For more information, see the documentation that came with your network card.

- 8 Tap **Finish**.
- 9 To manually start a connection, tap and hold the connection, and tap **Connect**.



NOTE: A VPN connection requires physical connection to a network. Ensure the unit is linked to a wire or wireless network before you manually start a VPN connection.

Ending a Connection

To disconnect:

- To delete a connection, tap and hold the connection you want to remove, and tap **Delete**.
- When connected through a cable or cradle, detach your device from the cable or cradle.
- When connected through the infrared sensor, move the device away from the computer.
- When connected through a network (Ethernet) card, remove the card from your device.

Connecting Directly to an E-Mail Server

You can set up a connection to an e-mail server so that you can send and receive e-mail messages using a modem or network connection and Messaging on your device.



NOTE: The ISP or network must use a POP3 or IMAP4 e-mail server and an SMTP gateway.

You can use multiple e-mail services to receive your messages. For each e-mail service you intend to use, you must first set up and name the e-mail service. If you want to use the same service to connect to different mailboxes, set up and name each mailbox connection.

To set up an e-mail service:

- 1 In **Messaging** on your device, tap **Accounts** → **New Account**.
- 2 Follow the directions in the E-mail Setup wizard.

For more information, tap **Start** → **Help**.

To connect to your e-mail server, tap **Account** → **Connect**. For more information on using the Messaging program, see "Messaging" on page 94.

Getting Help on Connecting

For more information on getting connected, see the following resources:

- "Messaging" on page 94.
- Online Help on the device. Tap **Start** → **Help**. Tap **Messaging** or **Connections**.
- ActiveSync Help on your computer. In ActiveSync, click **Help** → **Microsoft ActiveSync Help**.
- See www.microsoft.com/windowsmobile for troubleshooting information.

Adding and Removing Programs

Some programs are already installed in the ROM when you received your device. You cannot remove these programs or accidentally lose the ROM contents. You can update ROM programs using installation programs with the *.pku extension. You can save data to either ROM or RAM.

You can install any program created for your device, as long as your device has sufficient memory. The most popular place to find software for your device is on the Microsoft® Windows Mobile™ Version 5.0 software for Pocket PC Premium Edition website: www.microsoft.com/windowsmobile.

Adding Programs Using Microsoft® ActiveSync®

Before installing software on your device, you need to install ActiveSync on your computer. See ActiveSync Help on your computer for more information.

- 1 Determine your device and processor type so that you know which version of the software to install:
 - a Tap **Start** → **Settings**.
 - b On the **System** tab, tap **About**.
 - c From the **Version** tab, record the processor information.
- 2 Download the software to your computer (or insert the Getting Started CD or floppy that contains the software into your computer). You may see a single *.exe, *.zip file, a Setup.exe file, or several versions of files for different device types and processors. Ensure that you select the program designed for the Pocket PC and your device processor type.
- 3 Read any installation instructions, readme files, or documentation that comes with the program. Many programs provide special installation instructions.

- 4 Connect your device to your computer.
- 5 Double-click the *.exe file.

If the file is an installer file, the installation wizard begins. Follow the directions on the screen. Once the software is installed on your computer, the installer automatically transfers the software to your device.

If the file is not an installer file, you receive an error message stating that the program is valid but that it is designed for a different type of computer. You need to move this file to your device. If you cannot find any installation instructions for the program in the readme file or documentation, use ActiveSync Explore to copy the program file to the **Program Files** folder on your device. For more information on copying files using ActiveSync, see ActiveSync Help on your computer.

To open a program after the installation is complete, tap **Start** → **Programs**, and then tap the program icon.

Downloading Programs From the Internet

- 1 Determine your device and processor type so that you know which version of the software to install:
 - a Tap **Start** → **Settings**.
 - b On the **System** tab, tap **About**.
 - c From the **Version** tab, record the processor information.
- 2 Using Internet Explorer Mobile, download the program to your device. You may see a single *.exe, *.zip file, a **Setup.exe** file, or several versions of files for different device types and processors. Ensure that you select the program designed for the Pocket PC and your device processor type.
- 3 Read any installation instructions, readme files, or documentation that comes with the program. Many programs provide special installation instructions.
- 4 Tap the file, such as a *.exe file.

The installation wizard begins. Follow the directions on the screen.

Adding a Program to the Start Menu

- 1 Tap **Start** → **Settings**.
- 2 Tap **Menus** and then tap the check box for the program.

If the program is not listed, you can either use File Explorer on the device to move the program to the **Start Menu** folder, or use ActiveSync on the computer to create a shortcut to the program using the following steps:

- a Use Explorer in ActiveSync to explore your device files and locate the program.
- b Right-click the program and click **Create Shortcut**.
- c Move the shortcut to the **Start Menu** folder in the Windows folder. The shortcut now appears on the **Start** menu. For more information, see ActiveSync Help on your computer.

Removing Programs

- 1 Tap **Start** → **Settings**.
- 2 Tap **System** → **Remove Programs**.
- 3 Tap and hold the name of the program, and tap **Delete** in the pop-up menu.

If the program does not appear in the list of installed programs, use File Explorer on your device to locate the program.

Using Companion Programs

Companion programs include Word Mobile, Excel Mobile, PowerPoint Mobile, and Windows Media Player for Pocket PC.

To use a companion program on your device, tap **Start** → **Programs**, and then tap the program name.

Word Mobile

Word Mobile works with Microsoft Word on your computer to give you easy access to copies of your documents. You can create new documents on your device, or you can copy documents from your computer to your device. Synchronize documents between your computer and your device to have up-to-date content in both locations.

Use Word Mobile to create documents, such as letters, meeting minutes, and travel reports.

To create a new file:

- 1 Tap **Start** → **Programs** → **Word Mobile**.
- 2 Tap **New**.

A blank document appears. Or, if you selected a template for new documents in the **Options** dialog box, the template appears with the appropriate text and formatting already provided.

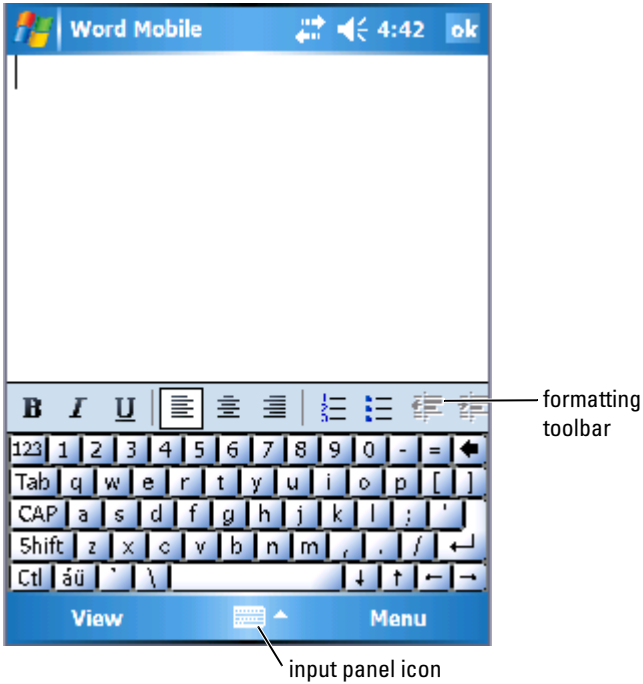

You can open only one document at a time. If you open a second document, you are asked to save the first one. You can create, save, or edit a document in a variety of formats, including Word (.doc), Word template (.dot), Rich Text Format (.rtf), and Plain Text (.txt).

Word Mobile contains a list of the files stored on your device. Tap a file in the list to open it. To delete files, make copies, or send files, tap and hold a file in the list. Then select the appropriate action in the pop-up menu.

You can enter information in Word Mobile by typing, writing, drawing, or recording. These modes appear on the **View** menu. Each mode has its own toolbar, which you can show and hide by tapping the **Show/Hide Toolbar** icon on the command bar.

To change the zoom magnification, tap **View** → **Zoom**, and then select the percentage you want. Select a higher percentage to enter text and a lower percentage to see more of your document.

If you are opening a Word document created on a computer, select **Wrap to Window** on the **View** menu, so that you can see the entire document.

Excel Mobile

Excel Mobile works with Microsoft Excel on your computer to give you easy access to copies of your workbooks. You can create new workbooks on your device, or you can copy workbooks from your computer to your device. Synchronize workbooks between your computer and your device, to have up-to-date content in both locations.

Use Excel Mobile to create workbooks, such as expense reports and mileage logs.

To create a new file:

- 1 Tap Start → Programs → Excel Mobile.
- 2 Tap New.

A blank workbook appears. Or, if you selected a template for new workbooks in the **Options** dialog box, the template appears with the appropriate formulae and formatting already provided.

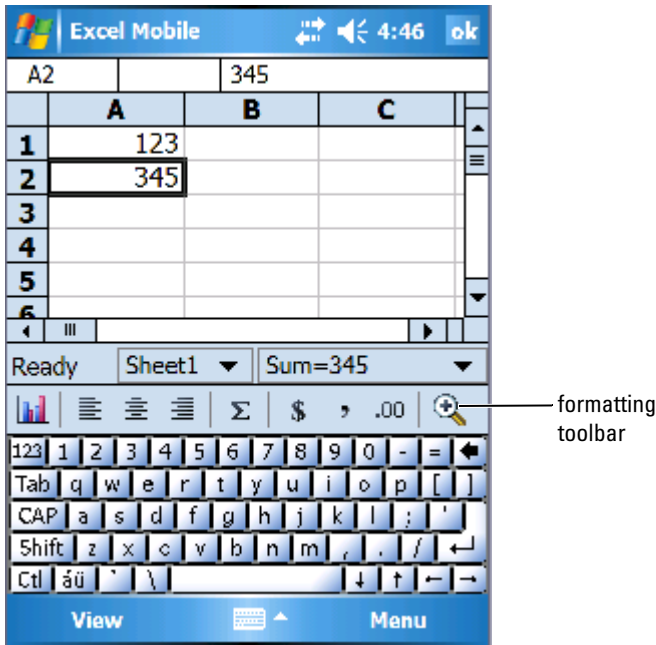

You can open only one workbook at a time. If you open a second workbook, you are asked to save the first one. You can create, save, or edit a workbook in a variety of formats, including Excel template (.xlt) and Excel (.xls).

Excel Mobile contains a list of the files stored on your device. Tap a file in the list to open it. To delete files, make copies, or send files, tap and hold a file in the list. Then select the appropriate action from the pop-up menu.

Excel Mobile provides fundamental spreadsheet tools, such as formulas, functions, sorting, and filtering. To display the toolbar, tap **View** → **Toolbar**.

Tips for Working in Excel Mobile

Use the following tips when working with large worksheets in Excel Mobile:

- Use Full Screen: Tap **View** → **Full Screen** to see as much of your worksheet as possible. To exit full-screen mode, tap **Restore**.
- Show and hide window elements: Tap **View** and then tap the elements you want to show or hide.
- Freeze panes on a worksheet: Select the cell where you want to freeze panes. Tap **View** → **Freeze Panes**. You might want to freeze the top and leftmost panes in a worksheet, to keep row and column labels visible as you scroll through a sheet.
- Split panes to view different areas of a large worksheet: Tap **View** → **Split**. Drag the split bar to where you want it. To remove the split, tap **View** → **Remove Split**.
- Show and hide rows and columns: To hide a row or column, select a cell in the row or column you want to hide. Tap **Menu** → **Format** → **Row** or **Column** → **Hide**. To show a hidden row or column, tap **Menu** → **Edit** → **Go To**, and then type a reference that is in the hidden row or column. Then tap **Menu** → **Format** → **Row** or **Column** → **Unhide**.

For more information on using Excel Mobile, tap **Start** → **Help**.

PowerPoint Mobile

PowerPoint Mobile works with Microsoft PowerPoint on your computer to give you easy access to copies of your presentation slides. Many presentation elements built into the slide shows, such as slide transitions and animations,

will play back on the device. If the presentation is set up as a timed slide show, one slide will advance to the next automatically. Links to URLs are also supported.

PowerPoint features not supported on the device include:

- **Notes:** Notes written for slides will not be visible.
- **Rearranging or editing slides:** PowerPoint Mobile is a viewer only.

To start a presentation:

- 1** Tap **Start** → **Programs** → **PowerPoint Mobile**.
- 2** In the presentation list, tap the slide show you want to view.
- 3** Tap the current slide to advance to the next slide.
If the presentation is set up as a timed slide show, slides will advance automatically.

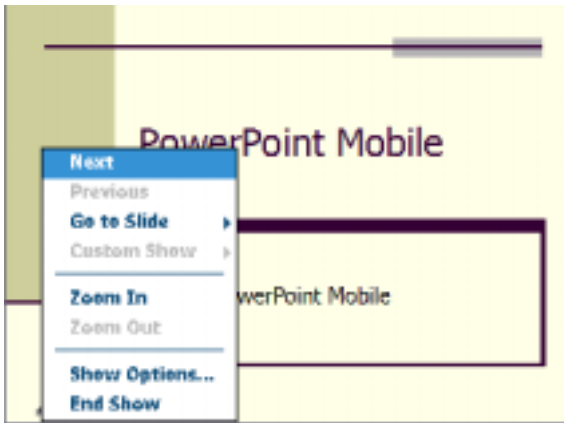

You can open only one document at a time. If you open a second document, you are asked to save and close the first one. You can view a document in a variety of formats, including PowerPoint (.ppt) and PowerPoint Mobile (.pps).

PowerPoint Mobile contains a list of the files stored on your device. Tap a file in the list to open it. To delete files, make copies, or send files, tap and hold a file in the list. Then select the appropriate action in the pop-up menu.

MSN Messenger

With the MSN Messenger instant message program, you can:

- See who is online.
- Send and receive instant messages.
- Have instant message conversations with groups of contacts.

To use MSN Messenger, you must have a Microsoft Passport account or a Microsoft Exchange e-mail account. You must have a Passport to use MSN Messenger Service. If you have a Hotmail or MSN account, you already have a Passport. Once you have obtained either a Microsoft Passport or a Microsoft Exchange account, you are ready to set up your account.



NOTE: Sign up for a Microsoft Passport account at www.passport.com. Get a free Microsoft Hotmail e-mail address at www.hotmail.com.

To switch to MSN Messenger, tap **Start** → **Programs** → **Pocket MSN** → **MSN Messenger**.

Setting Up

Before you can connect, you must enter Passport or Exchange account information.

To set up an account and sign in:

- 1 Tap **Start** → **Programs** → **Pocket MSN** → **MSN Messenger**.
- 2 Tap **Menu** → **Options**.
- 3 Enter your Passport or Exchange account information.
- 4 To sign in, tap the sign-in screen and enter your e-mail address and password.

Working With Contacts

The MSN Messenger window shows all of your messenger contacts at a glance, divided into **Online** and **Not Online** categories. From this view, while connected, you can chat, send an e-mail, block the contact from chatting with you, or delete contacts from your list using the pop-up menu.



NOTE: If you already use MSN Messenger on your computer, your contacts show up on your device without having to be added.

To see who is online without them seeing you, tap **Menu** → **My Status** → **Appear Offline**.

If you block a contact, you appear offline but remain on the blocked contact's list. To unblock a contact, tap and hold the contact, and then tap **Unblock** on the pop-up menu.

Chatting With Contacts

- Tap a contact name to open a chat window. Enter your message in the text entry area at the bottom of the screen, or tap **My Text** to enter a preset message, and then tap **Send**.
- To invite another contact to a multiuser chat, tap **Menu** → **Chats** → **Invite**, and then tap the contact you want to invite.
- To switch back to the main window without closing a chat, tap the **Contacts** icon. To revert back to your chat window, tap **Chats**, and select the person with whom you were chatting.
- To know if the contact you are chatting with is responding, look for a message under the text entry area.

For more information on using MSN Messenger, tap **Start** → **Help**.

Microsoft Windows Media[®] Player for Pocket PC

Use Windows Media Player for Pocket PC to play digital audio and video files that are stored on your device or on a network. To switch to Windows Media Player for Pocket PC, tap **Start** → **Windows Media**.

Use Windows Media Player on your computer to copy digital audio and video files to your Pocket PC. You can play Windows Media and MP3 files on your Pocket PC.

For more information about using Windows Media Player for Pocket PC, tap **Start** → **Help**.

Using Internet Explorer Mobile

Use Internet Explorer Mobile to view Web or WAP pages:

- During synchronization with your computer, download your favorite links and mobile favorites that are stored in the **Mobile Favorites** subfolder in Internet Explorer on your computer.
- Connect to an Internet service provider (ISP) or network and browse the web. For more information on connecting to the Internet, see "Getting Connected" on page 101.

When the device is connected to an ISP or network, you can also download files and programs from the Internet or intranet.

To use Internet Explorer Mobile, tap **Start** → **Internet Explorer**.

Mobile Favorites

If you are using Microsoft Internet Explorer 5.0 or later on your computer, you can download mobile favorites to your device. Synchronizing mobile favorites downloads web content to your device, so that you can view pages while you are disconnected from your ISP and computer. Use the Internet Explorer plug-in installed with Microsoft ActiveSync® to create mobile favorites quickly.

To create a mobile favorite on your computer and download it to your device:

- 1 On your computer, open Internet Explorer and click **Tools** → **Create Mobile Favorite**.
- 2 To change the link name, enter a new name in the **Name** box.
- 3 Specify an update schedule next to **Update** (optional).
- 4 Click **OK**.

Internet Explorer downloads the latest version of the page to your computer.

- 5 In Internet Explorer on the computer, right-click the mobile favorite and click **Properties**.

- 6 In the **Download** tab, specify the number of levels deep you want to download. To conserve device memory, go only one level deep.
- 7 Synchronize your device and computer.

Mobile favorites stored in the **Mobile Favorites** folder in Internet Explorer are downloaded to your device.

If you did not specify an update schedule in step 3, you need to manually download content to keep the information updated on your computer and device. Before synchronizing with your device, click **Tools** in Internet Explorer on your computer and click **Synchronize**. The date in the **Last Updated** column was the last time content was downloaded to the computer. You can manually download content, if necessary.



NOTE: You can add an icon to the Internet Explorer toolbar for creating mobile favorites. In Internet Explorer on your computer, click **View** → **Toolbars**, and then click **Customize**.

Conserving Memory

Mobile favorites take up storage memory on your device. To minimize the amount of memory used:

- Turn off pictures and sounds or stop some mobile favorites from being downloaded to the device in the **Favorites** settings in the ActiveSync options. For more information, see ActiveSync Help on your computer.
- Limit the number of downloaded linked pages. In Internet Explorer on the computer, right-click the mobile favorite you want to change and click **Properties**. On the **Download** tab, specify **0** or **1** for the number of linked pages you want to download.

Mobile Favorites Folder

Only items stored in the **Mobile Favorites** subfolder (in the **Favorites** folder) in Internet Explorer on your computer are synchronized with your device. The folder was created automatically when you installed ActiveSync.

Favorite Links

During synchronization, the list of favorites in the **Mobile Favorites** folder on your computer is synchronized with Internet Explorer Mobile on your device. The computer and the device are updated, with changes made to either list, each time you synchronize. Unless you mark the favorite link as a mobile favorite, only the link is downloaded to your device—you need to connect to your ISP or network to view the content. For more information on synchronization, see ActiveSync Help on your computer.

Browsing Mobile Favorites and the Web

You can use Internet Explorer Mobile to browse mobile favorites and channels that you have downloaded to your device without connecting to the Internet. You can also connect to the Internet through an ISP or a network connection and browse the Web.



favorites icon

To view mobile favorites and channels:

- 1 Tap the favorites icon to display your list of favorites.
- 2 Tap the page you want to view.

The page that was downloaded the last time you synchronized with your computer appears. If the page is not on your device, the favorite is dimmed. You need to synchronize with your computer again to download the page to your device, or connect to the Internet to view the page.

To browse the Internet, set up a connection to your ISP or corporate network using **Connections**, as described in "Getting Connected" on page 101.



NOTE: To add a favorite link, go to the page you want to add, tap and hold the page, and then tap **Add to Favorites**.

To connect to and browse the Internet, you can either:

- Tap the **Favorites** icon and tap the favorite you want to view.
- In the address field that appears at the top of the Internet Explorer screen, enter the Web address you want and tap the icon to the right, or the down arrow to select previously entered addresses.

Maintenance and Troubleshooting

Maintaining the Axim

To conduct periodic maintenance of your device, use the Dell Axim Self Diagnostic Utility available on the Getting Started CD. This diagnostic utility tests many features of your device: buttons, operating system version, battery status, video play, LED, driver, mirror mode, Bluetooth, Wireless, and USB Link Test.

Installing the Diagnostic Utility

To install the utility:

- 1 Create an ActiveSync connection between the device and a computer.
- 2 Insert the Getting Started CD into the computer's CD-ROM drive.
- 3 Click **Getting Started** → **Enhance Your Experience** → **Tools**.
- 4 On the tools selection menu, select **Pocket PC Applications**.
- 5 Scroll down the list until you see **Dell Axim X50/X50v Self-Diagnostic Utility**.
- 6 Click **Details** → **Install**.
- 7 Follow the instructions on the screen to install the Self-Diagnostic Utility.

To run a diagnostic, tap **Start** → **Programs** → **Axim Self-Diagnostics**.

Troubleshooting

The following table lists some common problems you might face and their probable solutions. To troubleshoot, use a single solution from the bullet list or a combination of solutions in the given order.

Problem	Solution
System not responding to screen taps	<ul style="list-style-type: none"> • Soft reset the device. • Check the button lock on left side of system. • Clean the touchscreen.
System not responding to button commands	<ul style="list-style-type: none"> • Check the button lock on left side of system. • Soft reset the device. • Check button assignment settings. • Tap Unlock on the Today screen if it is in locked state.
Device gives memory error	<ul style="list-style-type: none"> • Soft reset the device. • Hard reset the device but do not clear data. • Hard reset the device and clear data. • Run the device self diagnostics.
Bluetooth Keyboard not working	<ul style="list-style-type: none"> • Soft reset the device, then: <ul style="list-style-type: none"> • Tap Start → Settings → Dell Axim Executive Keyboard • Tap Enable and try to setup the keyboard again • Replace the batteries in the keyboard. • Hold Left CTRL, Left FN, Right FN for 3-5 seconds.

Problem	Solution
GPS Unit not showing in Bluetooth Manager after new search	Click New Partnership to start a fresh search for devices.
No GPS signal when placed on the dashboard	Many new cars from VW, BMW and Mercedes have a metal UV filter in the front window preventing GPS signals. Try placing the GPS unit near the rear window.
Waiting for GPS signal or no GPS Info in GPS Status Window	<ul style="list-style-type: none"> • Turn off and then turn on the GPS unit. • Check Bluetooth Manager for serial port connection. • Use Auto Detect in Navigation software to find correct COM port and Baud Rate. • Check GPS unit location - Top of unit must be able to "see" the sky.

File Download Security Warning

The following File Download Security Warning message appears when attempting to install software programs on your Dell system running Microsoft® Window® XP Service Pack 2 (SP2).

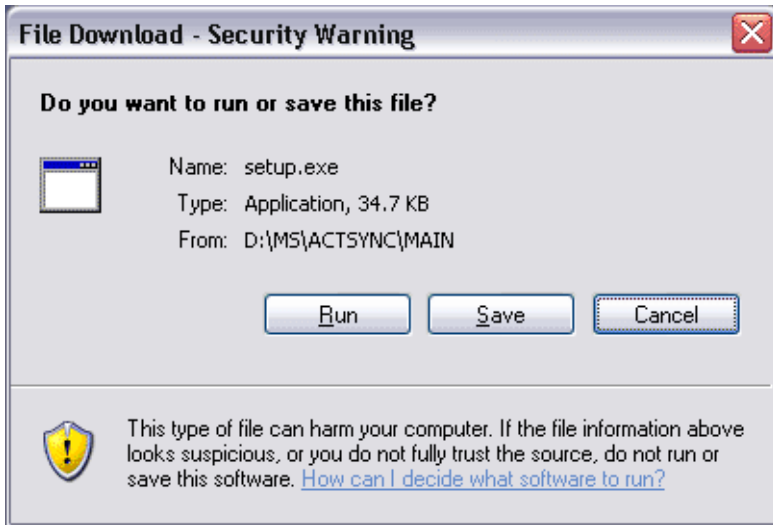

As a safety precaution, the File Download Security Warning appears whenever you attempt to install a software program on your system. This occurs regardless of who makes the software you are attempting to install.



NOTE: This warning does not indicate a problem with your Dell system.



Appendix

Specifications

System Information

Processor	Intel® XScale™ PXA270 processor at up to 624 MHz
Memory	
RAM	64-MB SDRAM
ROM	64-MB or 128-MB Intel® StrataFlash™ ROM
Operating System	Microsoft® Windows Mobile™ Version 5.0 software for Pocket PC Premium Edition

Display

Type	QVGA, VGA TFT Color 16-bit, touch-sensitive, transreflective display
Size	3.5 inches (QVGA) 3.7 inches (VGA)
Resolution	240 x 320 at 65,536 colors (QVGA) 480 x 640 at 65,536 colors (VGA)
LCD brightness	QVGA: 100 nits VGA: 100 nits

Controls and Lights

Navigation	5-way navigation button
Buttons:	four program buttons: Calendar, Contacts, Messaging, Home power on/off on/off button for WLAN/Bluetooth [®] wireless technology voice record button reset button lock button
Lights:	synchronization/communication event notification charge status

Expansion Slots

Secure Digital memory card	one Secure Digital memory card slot (3.3v) supports 1-bit and 4-bit SDIO card
CompactFlash card	one CompactFlash Type II card slot (3.3v)

Ports and Connectors

Infrared	standard v1.2 (115 kbps)
Cradle/synchronization connector	36-pin connector
Audio	stereo headphone connector and mono microphone connector

Physical

Dimensions:	
Length	119.0 mm (4.69 inches)
Width	73.0 mm (2.87 inches)

Physical (continued)

Height	16.9 mm (0.67 inch)
Weight	165 g (0.36 lb) QVGA with standard battery 175 g (0.38 lb) VGA with standard battery

NOTE: The weight described refers to the device, not including the CompactFlash card or the Secure Digital memory card.

Audio

Audio controller	WM8750L sound chip
Stereo conversion	16-bit stereo; 8.0-, 11.025-, 22.05-, and 44.1-KHz sample rate
Record	full duplex record and playback
Microphone/speaker	integrated
Headphone	stereo connector

Wireless Connectivity

WLAN (802.11b)	
Network standard	IEEE 802.11b
Data rate	1 Mbps, 2 Mbps, 5.5 Mbps, 11 Mbps
Modulation	CCK (11 Mbps, 5.5 Mbps); DQPSK (2 Mbps); DBSPK (1 Mbps)
Network architecture	ad-hoc and infrastructure
Operating frequencies	2.4–2.497 GHz
Operating channels	1–11 (North America); 1–13 (Europe and Japan)
RF output power	13.0 dBm maximum
Range	indoor — up to 10 m (120 ft) at 5 Mbps and 75 m at 0.5 Mbps

Wireless Connectivity (continued)

Client utility	automatic location profile, site survey, diagnostics, current link status, ping
Software support	Wi-Fi certified
Lights	green (WLAN status) blue (Bluetooth wireless technology status)
Switch	manual radio on/off (hardware button and software switch) to comply with aviation restrictions
Bluetooth wireless technology	2.4-GHz ISM band operation; compatible Bluetooth 1.2 wireless technology; includes manager for Bluetooth with wireless technology; Class II device; Max 4 dBm o/p power; 3.3V operation; UART interface

Power Supply

Battery type:

Main	1100-mAh lithium-ion removable, rechargeable battery (standard) 2200-mAh lithium-ion removable, rechargeable battery (optional)
Backup	20-mAh rechargeable nickel metal hydride button cell

AC adapter:

Supply voltage	100–240 VAC
Frequency	50–60 Hz
Current consumption	0.4 A
Output voltage	5.4 VDC
Output current	2.41 A

Environmental

Temperature range:

operating	0° to 40°C (32° to 104°F)
storage	-20° to 60°C (-4° to 140°F)

Thermal gradient:

operating	15°C (59°F) per hour maximum
storage	20°C (68°F) per hour maximum

Relative humidity (maximum):

operating	10% to 90% non-condensing
storage	5% to 95% non-condensing

Altitude (maximum):

operating	0 to 3048 m (0 to 10,000 ft)
storage	0 to 12,190 m (0 to 40,000 ft)

Maximum shock (measured with a 2 ms half-sine pulse):

operating	200 G
storage	400 G

Maximum vibration (using a random-vibration spectrum that simulates user environment):

operating	2.6 GRMS
storage	3.41 GRMS

Dell™ Software License Agreement

This is a legal agreement between you, the user, and Dell Products, L.P. ("Dell"). This agreement covers all software that is distributed with the Dell product, for which there is no separate license agreement between you and the manufacturer or owner of the software (collectively the "Software"). This agreement is not for the sale of Software or any other intellectual property. All title and intellectual property rights in and to Software is owned by the manufacturer or owner of the Software. All rights not expressly granted under this agreement are reserved by the manufacturer or owner of the Software. By opening or breaking the seal on the Software packet(s), installing or downloading the Software, or using the Software that has been preloaded or is embedded in your product, you agree to be bound by the terms of this agreement. If you do not agree to these terms, promptly return all Software items (disks, written materials, and packaging) and delete any preloaded or embedded Software.

You may use one copy of the Software on only one product at a time. If you have multiple licenses for the Software, you may use as many copies at any time as you have licenses. "Use" means loading the Software in temporary memory or permanent storage on the product. Installation on a network server solely for distribution to other products is not "use" if (but only if) you have a separate license for each product to which the Software is distributed. You must ensure that the number of persons using the Software installed on a network server does not exceed the number of licenses that you have. If the number of users of Software installed on a network server will exceed the number of licenses, you must purchase additional licenses until the number of licenses equals the number of users before allowing additional users to use the Software. If you are a commercial customer of Dell or a Dell affiliate, you hereby grant Dell, or an agent selected by Dell, the right to perform an audit of your use of the Software during normal business hours, you agree to cooperate with Dell in such audit, and you agree to provide Dell with all records reasonably related to your use of the Software. The audit will be limited to verification of your compliance with the terms of this agreement.

The Software is protected by United States copyright laws and international treaties. You may make one copy of the Software solely for backup or archival purposes or transfer it to a single hard disk provided you keep the original solely for backup or archival purposes. You may not rent or lease the Software or copy the written materials accompanying the Software, but you may transfer the Software and all accompanying materials on a permanent basis as part of a sale or transfer of the Dell product if you retain no copies and the recipient agrees to the terms hereof. Any transfer must include the most recent update and all prior versions. You may not reverse engineer, decompile, or disassemble the Software. If the package accompanying your product contains compact discs, 3.5", and/or 5.25" disks, you may use only the disks appropriate for your product. You may not use the disks on another computer or network, or loan, rent, lease, or transfer them to another user except as permitted by this agreement.

Limited Warranty

Dell warrants that the Software disks will be free from defects in materials and workmanship under normal use for ninety (90) days from the date you receive them. This warranty is limited to you and is not transferable. Any implied warranties are limited to ninety (90) days from the date you receive the Software. Some jurisdictions do not allow limits on the duration of an implied warranty, so this limitation may not apply to you. The entire liability of Dell and its suppliers, and your exclusive remedy, shall be (a) return of the price paid for the Software or (b) replacement of any disk not meeting this warranty that is sent with a return authorization number to Dell, at your cost and risk. This limited warranty is void if any disk damage has resulted from accident, abuse, misapplication, or service or modification by someone other than Dell. Any replacement disk is warranted for the remaining original warranty period or thirty (30) days, whichever is longer.

Dell does NOT warrant that the functions of the Software will meet your requirements or that operation of the Software will be uninterrupted or error free. You assume responsibility for selecting the Software to achieve your intended results and for the use and results obtained from the Software.

DELL, ON BEHALF OF ITSELF AND ITS SUPPLIERS, DISCLAIMS ALL OTHER WARRANTIES, EXPRESS OR IMPLIED, INCLUDING, BUT NOT LIMITED TO, IMPLIED WARRANTIES OF MERCHANTABILITY AND FITNESS FOR A PARTICULAR PURPOSE, FOR THE SOFTWARE AND ALL ACCOMPANYING WRITTEN MATERIALS. This limited warranty gives you specific legal rights; you may have others, which vary from jurisdiction to jurisdiction.

IN NO EVENT SHALL DELL OR ITS SUPPLIERS BE LIABLE FOR ANY DAMAGES WHATSOEVER (INCLUDING, WITHOUT LIMITATION, DAMAGES FOR LOSS OF BUSINESS PROFITS, BUSINESS INTERRUPTION, LOSS OF BUSINESS INFORMATION, OR OTHER PECUNIARY LOSS) ARISING OUT OF USE OR INABILITY TO USE THE SOFTWARE, EVEN IF ADVISED OF THE POSSIBILITY OF SUCH DAMAGES. Because some jurisdictions do not allow an exclusion or limitation of liability for consequential or incidental damages, the above limitation may not apply to you.

U.S. Government Restricted Rights

The software and documentation are "commercial items" as that term is defined at 48 C.F.R. 2.101, consisting of "commercial computer software" and "commercial computer software documentation" as such terms are used in 48 C.F.R. 12.212. Consistent with 48 C.F.R. 12.212 and 48 C.F.R. 227.7202-1 through 227.7202-4, all U.S. Government end users acquire the software and documentation with only those rights set forth herein. Contractor/manufacturer is Dell Products, L.P., One Dell Way, Round Rock, Texas 78682.

General

This license is effective until terminated. It will terminate upon the conditions set forth above or if you fail to comply with any of its terms. Upon termination, you agree that the Software and accompanying materials, and all copies thereof, will be destroyed. This agreement is governed by the laws of the State of Texas. Each provision of this agreement is severable. If a provision is found to be unenforceable, this finding does not affect the enforceability of the remaining provisions, terms, or conditions of this agreement. This agreement is binding on successors and assigns. Dell agrees and you agree to waive, to the maximum extent permitted by law, any right to a jury trial with respect to the Software or this agreement. Because this waiver may not be effective in some jurisdictions, this waiver may not apply to you. You acknowledge that you have read this agreement, that you understand it, that you agree to be bound by its terms, and that this is the complete and exclusive statement of the agreement between you and Dell regarding the Software.

Regulatory Notices

Electromagnetic Interference (EMI) is any signal or emission, radiated in free space or conducted along power or signal leads, that endangers the functioning of a radio navigation or other safety service or seriously degrades, obstructs, or repeatedly interrupts a licensed radio communications service. Radio communications services include but are not limited to AM/FM commercial broadcast, television, cellular services, radar, air-traffic control, pager, and Personal Communication Services (PCS). These licensed services, along with unintentional radiators such as digital devices, including computers, contribute to the electromagnetic environment.

Electromagnetic Compatibility is the ability of items of electronic equipment to function properly together in the electronic environment. While this computer has been designed and determined to be compliant with regulatory agency limits for EMI, there is no guarantee that interference will not occur in a particular installation. If this equipment does cause interference with radio communications services, which can be determined by turning the equipment off and on, you are encouraged to try to correct the interference by one or more of the following measures:

- Reorient the receiving antenna.
- Relocate the computer with respect to the receiver.
- Move the computer away from the receiver.
- Plug the computer into a different outlet so that the computer and the receiver are on different branch circuits.

If necessary, consult a Dell Technical Support representative or an experienced radio/television technician for additional suggestions.

For additional regulatory information, see the owner's manual or user's guide for your computer.

Dell™ computers are designed, tested, and classified for their intended electromagnetic environment. These electromagnetic environment classifications generally refer to the following harmonized definitions:

- Class A is typically for business or industrial environments.
- Class B is typically for residential environments.

Information Technology Equipment (ITE), including devices, expansion cards, printers, input/output (I/O) devices, monitors, and so on, that are integrated into or connected to the computer should match the electromagnetic environment classification of the computer.

A Notice About Shielded Signal Cables: Use only shielded cables for connecting devices to any Dell device to reduce the possibility of interference with radio communications services. Using shielded cables ensures that you maintain the appropriate Electromagnetic Compatibility classification for the intended environment. Cables are available from Dell at www.dell.com.

Most Dell computers are classified for Class B environments. However, the inclusion of certain options can change the rating of some configurations to Class A. To determine the electromagnetic classification for your computer or device, see the following sections specific for each regulatory agency. Each section provides country-specific Electromagnetic Compatibility/EMI or product safety information.

FCC Notices (U.S. Only)

Most Dell computer systems are classified by the Federal Communications Commission (FCC) as Class B digital devices. To determine which classification applies to your computer system, examine all FCC registration labels located on the bottom, side, or back panel of your computer, on card-mounting brackets, and on the cards themselves. If any one of the labels carries a Class A rating, your entire system is considered to be a Class A digital device. If *all* labels carry an FCC Class B rating as distinguished by either an FCC ID number or the FCC logo, (**FC**), your system is considered to be a Class B digital device.

Once you have determined your system's FCC classification, read the appropriate FCC notice. Note that FCC regulations provide that changes or modifications not expressly approved by Dell could void your authority to operate this equipment.

This device complies with Part 15 of the FCC Rules. Operation is subject to the following two conditions:

- This device may not cause harmful interference.
- This device must accept any interference received, including interference that may cause undesired operation.

Class A

This equipment has been tested and found to comply with the limits for a Class A digital device pursuant to Part 15 of the FCC Rules. These limits are designed to provide reasonable protection against harmful interference when the equipment is operated in a commercial environment. This equipment generates, uses, and can radiate radio frequency energy and, if not installed and used in accordance with the manufacturer's instruction manual, may cause harmful interference with radio communications. Operation of this equipment in a residential area is likely to cause harmful interference, in which case you will be required to correct the interference at your own expense.

Class B

This equipment has been tested and found to comply with the limits for a Class B digital device pursuant to Part 15 of the FCC Rules. These limits are designed to provide reasonable protection against harmful interference in a residential installation. This equipment generates, uses, and can radiate radio frequency energy and, if not installed and used in accordance with the manufacturer's instruction manual, may cause interference with radio communications. However, there is no guarantee that interference will not occur in a particular installation. If this equipment does cause harmful interference to radio or television reception, which can be determined by turning the equipment off and on, you are encouraged to try to correct the interference by one or more of the following measures:

- Reorient or relocate the receiving antenna.
- Increase the separation between the equipment and the receiver.
- Connect the equipment into an outlet on a circuit different from that to which the receiver is connected.
- Consult the dealer or an experienced radio/television technician for help.

FCC Identification Information

The following information is provided on the device or devices covered in this document in compliance with FCC regulations:

- Models: HC03U, HC03UL, and HD04U
- Company name:

Dell Inc.
One Dell Way
Round Rock, Texas 78682 USA
512-338-4400

IC Notice (Canada Only)

Most Dell computers (and other Dell digital apparatus) are classified by the Industry Canada (IC) Interference-Causing Equipment Standard #3 (ICES-003) as Class B digital devices. To determine which classification (Class A or B) applies to your computer (or other Dell digital apparatus), examine all registration labels located on the bottom, side, or the back panel of your computer (or other digital apparatus). A statement in the form of "IC Class A ICES-003" or "IC Class B ICES-003" will be located on one of these labels. Note that Industry Canada regulations provide that changes or modifications not expressly approved by Dell could void your authority to operate this equipment.

This Class B (or Class A, if so indicated on the registration label) digital apparatus meets the requirements of the Canadian Interference-Causing Equipment Regulations.

Cet appareil numérique de la Classe B (ou Classe A, si ainsi indiqué sur l'étiquette d'enregistrement) respecte toutes les exigences du Règlement sur le Matériel Brouilleur du Canada.

Australia and New Zealand



NOM Information (Mexico Only)

The following information is provided on the device(s) described in this document in compliance with the requirements of the official Mexican standards (NOM):

Exporter:	Dell Inc. One Dell Way Round Rock, TX 78682
Importer:	Dell Computer de México, S.A. de C.V. Paseo de la Reforma 2620 - 11° Piso Col. Lomas Altas 11950 México, D.F.
Ship to:	Dell Computer de México, S.A. de C.V. al Cuidado de Kuehne & Nagel de México S. de R.I. Avenida Soles No. 55 Col. Peñon de los Baños 15520 México, D.F.
Models:	HC03U, HC03UL, and HD04U
Supply voltage:	100–240 VAC
Frequency:	50–60 Hz
Current Consumption:	0.4 A
Output voltage:	5.4 VDC
Output current:	2.41 A

Wireless Regulatory Information

The Dell™ Axim™ X50 device must be used in strict accordance with the manufacturer's instructions as described in the user documentation that comes with the product. For country-specific approvals, see Radio approvals. Dell Inc. is not responsible for any radio or television interference caused by unauthorized modification of the device, or the substitution or attachment of connecting cables and equipment other than that specified by Dell Inc. The correction of interference caused by such unauthorized modification, substitution or attachment is the responsibility of the user. Dell Inc. and its authorized resellers or distributors are not liable for any damage or violation of government regulations that may arise from the user failing to comply with these guidelines.

Japan Standard

STD-T66 (Ver 1.0)

Canada—Industry Canada (IC)

This device complies with RSS210 of Industry Canada. Operation of the device is subject to the following two conditions:

- This device may not cause harmful interference.
- This device must accept any interference that may cause undesired operation.

FCC Standard

47 CFR Part 15, Subpart C (Section 15.247). This version is limited to channel 1 to channel 11 by specified firmware controlled in the U.S.A.

Federal Communications Commission (FCC)

This device complies with Part 15 of the FCC Rules. Operation of the device is subject to the following two conditions:

- This device may not cause harmful interference.
- This device must accept any interference that may cause undesired operation.

NOTE: The radiated output power of this Dell Axim X50 device is far below the FCC radio frequency exposure limits. Nevertheless, the Dell Axim X50 device should be used in such a manner that the potential for human contact during normal operation is minimized. To determine the location of the antenna within your computer, check the information posted on the general Dell support site at support.dell.com.

Interference Statement

This equipment has been tested and found to comply with the limits for a Class B digital device, pursuant to Part 15 of the FCC Rules. These limits are designed to provide reasonable protection against harmful interference in a residential installation. This equipment generates, uses, and can radiate radio frequency energy. If the equipment is not installed and used in accordance with the instructions, the equipment may cause harmful interference to radio communications. There is no guarantee, however, that such interference will not occur in a particular installation. If this equipment does cause harmful interference to radio or television reception (which can be determined by turning the equipment off and on), the user is encouraged to try to correct the interference by taking one or more of the following measures:

- Reorient or relocate the receiving antenna.
- Increase the distance between the equipment and the receiver.
- Connect the equipment to an outlet on a circuit different from that to which the receiver is connected.
- Consult the dealer or an experienced radio/TV technician for help.

NOTE: This Dell Axim X50 device must be installed and used in strict accordance with the manufacturer's instructions as described in the user documentation that comes with the product. Any other installation or use will violate FCC Part 15 regulations.

NOTE: FCC Radiation Exposure Statement:

This equipment complies with FCC RF radiation exposure limits set forth for an uncontrolled environment. End users must follow the specific operating instructions for satisfying RF exposure compliance. This device has been tested and demonstrated compliance when Bluetooth wireless technology and WLAN are transmitting simultaneously. This device must not be co-located or operating in conjunction with any other antenna or transmitter

Mexico

MEC SCT RCPUSCF02-609

Singapore—Approved by IDA for Use in Singapore

DA102617

Brazil



Este equipamento opera em caráter secundario, isto é não tem direito a proteção contra interferência prejudicial, mesmo de estações do mesmo tipo, e não causar interferência a sistema operando em caráter primário.

Radio Approvals

To determine whether you are allowed to use your wireless network device in a specific country, please check to see if the radio type number that is printed on the identification label of your device is listed on the radio approval list posted on the general Dell support site at support.dell.com.

Limited Warranties

Dell-branded hardware products purchased in the U.S. or Canada come with either a 90-day, 1-year, 2-year, 3-year, or 4-year limited warranty, depending on the product purchased. To determine which warranty came with your hardware product(s), see your packing slip or invoice. The following sections describe the limited warranties and return policy for the U.S., the limited warranties and return policy for Canada, the manufacturer guarantee for Latin America and the Caribbean, and the Intel® Pentium® and Celeron® warranty for the U.S. and Canada.

Limited Warranty for Dell-Branded Hardware Products (U.S. Only)

What is covered by this limited warranty?

This limited warranty covers defects in materials and workmanship in your—our end-user customer's—Dell-branded hardware products, including Dell-branded peripheral products.

What is not covered by this limited warranty?

This limited warranty does not cover:

- Software, including the operating system and software added to the Dell-branded hardware products through our factory-integration system, third-party software, or the reloading of software
- Non-Dell-branded and Solution Provider Direct products and accessories
- Problems that result from:
 - External causes such as accident, abuse, misuse, or problems with electrical power
 - Servicing not authorized by Dell
 - Usage that is not in accordance with product instructions
 - Failure to follow the product instructions or failure to perform preventive maintenance
 - Problems caused by using accessories, parts, or components not supplied by Dell
- Products with missing or altered Service Tags or serial numbers
- Products for which Dell has not received payment

THIS WARRANTY GIVES YOU SPECIFIC LEGAL RIGHTS, AND YOU MAY ALSO HAVE OTHER RIGHTS WHICH VARY FROM STATE TO STATE (OR JURISDICTION TO JURISDICTION). DELL'S RESPONSIBILITY FOR MALFUNCTIONS AND DEFECTS IN HARDWARE IS LIMITED TO REPAIR AND REPLACEMENT AS SET FORTH IN THIS WARRANTY STATEMENT. ALL EXPRESS AND IMPLIED WARRANTIES FOR THE PRODUCT, INCLUDING BUT NOT LIMITED TO ANY IMPLIED WARRANTIES AND CONDITIONS OF MERCHANTABILITY AND FITNESS FOR A PARTICULAR PURPOSE, ARE LIMITED IN TIME TO THE TERM OF THE LIMITED WARRANTY PERIOD REFLECTED ON YOUR PACKING SLIP OR INVOICE. NO WARRANTIES, WHETHER EXPRESS OR IMPLIED, WILL APPLY AFTER THE LIMITED WARRANTY PERIOD HAS EXPIRED. SOME STATES DO NOT ALLOW LIMITATIONS ON HOW LONG AN IMPLIED WARRANTY LASTS, SO THIS LIMITATION MAY NOT APPLY TO YOU.

WE DO NOT ACCEPT LIABILITY BEYOND THE REMEDIES PROVIDED FOR IN THIS LIMITED WARRANTY OR FOR CONSEQUENTIAL OR INCIDENTAL DAMAGES, INCLUDING, WITHOUT LIMITATION, ANY LIABILITY FOR THIRD-PARTY CLAIMS AGAINST YOU FOR DAMAGES, FOR PRODUCTS NOT BEING AVAILABLE FOR USE, OR FOR LOST DATA OR LOST SOFTWARE. OUR LIABILITY WILL BE NO MORE THAN THE AMOUNT YOU PAID FOR THE PRODUCT THAT IS THE SUBJECT OF A CLAIM. THIS IS THE MAXIMUM AMOUNT FOR WHICH WE ARE RESPONSIBLE.

SOME STATES DO NOT ALLOW THE EXCLUSION OR LIMITATION OF INCIDENTAL OR CONSEQUENTIAL DAMAGES, SO THE ABOVE LIMITATION OR EXCLUSION MAY NOT APPLY TO YOU.

How long does this limited warranty last?

This limited warranty lasts for the time period indicated on your packing slip or invoice, except for the following Dell-branded hardware:

- Portable computer batteries carry a 1-year limited warranty.
- Projector lamps carry a 90-day limited warranty.
- Memory carries a lifetime limited warranty.
- Monitors carry the longer of either a 3-year limited warranty or the remainder of the warranty for the Dell computer to which the monitor will be connected.
- "PDAs, MP3 players, earphones, remote online controls, and AC adapters carry a 1-year limited warranty.
- Other add-on hardware carries the longer of either a 1-year limited warranty for new parts and a 90-day limited warranty for reconditioned parts or, for both new and reconditioned parts, the remainder of the warranty for the Dell computer on which such parts are installed.

The limited warranty on all Dell-branded products begins on the date of the packing slip or invoice. The warranty period is not extended if we repair or replace a warranted product or any parts. Dell may change the availability of limited warranties, at its discretion, but any changes will not be retroactive.

What do I do if I need warranty service?

Before the warranty expires, please call us at the relevant number listed in the following table. Please also have your Dell Service Tag or order number available.

Individual Home Consumers:	U.S. Only
Technical Support	1-800-624-9896
Customer Service	1-800-624-9897
Individual Home Consumers who purchased through an Employee Purchase Program:	
Technical Support and Customer Service	1-800-822-8965
Home and Small Business Commercial Customers:	
Technical Support and Customer Service	1-800-456-3355
Medium, Large, or Global Commercial Customers, Healthcare Customers, and Value-Added Resellers (VARs):	
Technical Support and Customer Service	1-800-822-8965
Government and Education Customers:	
Technical Support and Customer Service	1-800-234-1490
Dell-Branded Memory	1-888-363-5150

What will Dell do?

During the 90 days of the 90-day limited warranty and the first year of all other limited warranties: During the 90 days of the 90-day limited warranty and the first year of all other limited warranties, we will repair any Dell-branded hardware products returned to us that prove to be defective in materials or workmanship. If we are not able to repair the product, we will replace it with a comparable product that is new or refurbished.

When you contact us, we will issue a Return Material Authorization Number for you to include with your return. You must return the products to us in their original or equivalent packaging, prepaid shipping charges, and insure the shipment or accept the risk if the product is lost or damaged in shipment. We will return the repaired or replacement products to you. We will pay to ship the repaired or replaced products to you if you use an address in the United States (excluding Puerto Rico and U.S. possessions and territories). Otherwise, we will ship the product to you freight collect.

If we determine that the product is not covered under this warranty, we will notify you and inform you of service alternatives that are available to you on a fee basis.

NOTE: Before you ship the product(s) to us, make sure to back up the data on the hard drive(s) and any other storage device(s) in the product(s). Remove any confidential, proprietary, or personal information and removable media such as floppy disks, CDs, or PC Cards. We are not responsible for any of your confidential, proprietary, or personal information; lost or corrupted data; or damaged or lost removable media.

During the remaining years: For the remaining period of the limited warranty, we will replace any defective part with new or refurbished parts, if we agree that it needs to be replaced. When you contact us, we will require a valid credit card number at the time you request a replacement part, but we will not charge you for the replacement part as long as you return the original part to us within 30 days after we ship the replacement part to you. If we do not receive the original part within 30 days, we will charge to your credit card the then-current standard price for that part.

We will pay to ship the part to you if you use an address in the United States (excluding Puerto Rico and U.S. possessions and territories). Otherwise, we will ship the part freight collect. We will also include a prepaid shipping container with each replacement part for your use in returning the replaced part to us.

NOTE: Before you replace parts, make sure to back up the data on the hard drive(s) and any other storage device(s) in the product(s). We are not responsible for lost or corrupted data.

What if I purchased a service contract?

If your service contract is with Dell, service will be provided to you under the terms of the service agreement. Please refer to that contract for details on how to obtain service.

If you purchased through us a service contract with one of our third-party service providers, please refer to that contract for details on how to obtain service.

How will you fix my product?

We use new and refurbished parts made by various manufacturers in performing warranty repairs and in building replacement parts and systems. Refurbished parts and systems are parts or systems that have been returned to Dell, some of which were never used by a customer. All parts and systems are inspected and tested for quality. Replacement parts and systems are covered for the remaining period of the limited warranty for the product you bought. Dell owns all parts removed from repaired products.

May I transfer the limited warranty?

Limited warranties on systems may be transferred if the current owner transfers ownership of the system and records the transfer with us. The limited warranty on Dell-branded memory may not be transferred. You may record your transfer by going to Dell's website:

- If you are an Individual Home Consumer, go to www.dell.com/us/en/dhs/topics/sbtopic_015_ccare.htm
- If you are a Home Office, Small, Medium, Large, or Global Commercial Customer, go to www.dell.com/us/en/biz/topics/sbtopic_ccare_nav_015_ccare.htm
- If you are a Government, Education, or Healthcare Customer, or an Individual Home Consumer who purchased through an Employee Purchase Program, go to www.dell.com/us/en/pub/topics/sbtopic_015_ccare.htm

If you do not have Internet access, call your customer care representative or call 1-800-624-9897.

Total Satisfaction Return Policy (U.S. Only)

We value our relationship with you and want to make sure that you're satisfied with your purchases. That's why we offer a "Total Satisfaction" return policy for most products that you—the end-user customer—purchase directly from Dell. Under this policy, you may return to Dell products that you purchased directly from Dell for a credit or a refund of the purchase price paid, less shipping and handling and applicable return fees as follows:

New Hardware Products and Accessories: Unless you have a separate agreement with Dell, all hardware, accessories, peripherals, parts and unopened software still in its/their sealed package, excluding the products listed below, may be returned within twenty-one (21) days from the date on the packing slip or invoice.

Exclusions from the foregoing return policy:

- New PowerEdge™, PowerConnect™, and PowerVault™ products (excluding PowerVault 160T tape libraries) may be returned within thirty (30) days from the date on the packing slip or invoice, except that new PowerEdge™ SC servers and n series products purchased from the Small and Medium Business Sales Division may only be returned within fourteen (14) days from the date on the packing slip or invoice.
- Application software or an operating system that has been installed by Dell may not be returned unless you return the entire computer under the 21-day return policy, if applicable to your purchase (if not applicable to your purchase, you may not return application software or an operating system).

- Non-defective third party and Dell-branded software, peripheral, electronics and accessory products (for example: televisions, printers, projectors, MP3 players, PDAs, battery chargers, non-preinstalled third party software, wireless cards/access points/routers), including but not limited to those sold by or through Dell's "Software & Peripherals" or "Electronics & Accessories" groups, may be returned within twenty-one (21) days from the date on the packing slip or invoice, but a fifteen percent (15%) return fee may be deducted from any refund or credit.
- Dell | EMC storage products, EMC-branded products, Unisys-branded products, PowerVault™ 160T tape libraries, enterprise software, non-Dell branded enterprise products, software and/or software licenses, or any non-Dell customized hardware and/or software product(s) may not be returned at any time.

Reconditioned or Refurbished Dell-Branded Hardware Products and Parts — All reconditioned or refurbished PowerEdge™, PowerConnect™, and PowerVault™ products may be returned within 30 days from the date on the packing slip or invoice. All other reconditioned or refurbished Dell-branded hardware products and parts may be returned within 14 days of the date on the packing slip or invoice.

How to Return — To return products, e-mail or call Dell customer service to receive a Credit Return Authorization Number within the return policy period applicable to the product you want to return. You must obtain a Credit Return Authorization Number in order to return the product. See "Contacting Dell" or "Getting Help" in your customer documentation (or www.dell.com/us/en/gen/contact.htm) to find the appropriate contact information for obtaining customer assistance.

You must ship the products to Dell within 5 days of the date that Dell issues the Credit Return Authorization Number. You must also return the products to Dell in their original packaging, in as-new condition along with any media, documentation, and all other items that were included in the original shipment, prepay shipping charges, and insure the shipment or accept the risk of loss or damage during shipment.

NOTE: Before you ship the product(s) to us, make sure to back up the data on the hard drive(s) and any other storage device(s) in the product(s). Remove any confidential, proprietary, or personal information and removable media such as floppy disks, CDs, or PC Cards. We are not responsible for any of your confidential, proprietary, or personal information; lost or corrupted data; or damaged or lost removable media.

Limited Warranty Terms for Dell-Branded Hardware Products (Canada Only)

What is covered by this limited warranty?

This limited warranty covers defects in materials and workmanship in your—our end-user customer's—Dell-branded hardware products, including Dell-branded peripheral products.

What is not covered by this limited warranty?

This limited warranty does not cover:

- Software, including the operating system and software added to the Dell-branded hardware products through our factory-integration system, or the reloading of the software
- Non-Dell branded and Solution Provider Direct products and accessories
- Problems that result from:
 - External causes such as accident, abuse, misuse, or problems with electrical power
 - Servicing not authorized by Dell
 - Usage that is not in accordance with product instructions
 - Failure to follow the product instructions or failure to perform preventive maintenance
 - Problems caused by using accessories, parts, or components not supplied by Dell
- Products with missing or altered Service Tags or serial numbers
- Products for which Dell has not received payment

THIS WARRANTY GIVES YOU SPECIFIC LEGAL RIGHTS, AND YOU MAY ALSO HAVE OTHER RIGHTS WHICH VARY FROM PROVINCE TO PROVINCE. DELL'S RESPONSIBILITY FOR MALFUNCTIONS AND DEFECTS IN PRODUCT IS LIMITED TO REPAIR AND REPLACEMENT AS SET FORTH IN THIS WARRANTY STATEMENT, FOR THE TERM OF THE WARRANTY PERIOD REFLECTED ON YOUR PACKING SLIP OR INVOICE. EXCEPT FOR THE EXPRESS WARRANTIES CONTAINED IN THIS WARRANTY STATEMENT, DELL DISCLAIMS ALL OTHER WARRANTIES AND CONDITIONS, EXPRESS OR IMPLIED, INCLUDING WITHOUT LIMITATION IMPLIED WARRANTIES AND CONDITIONS OF MERCHANTABILITY AND FITNESS FOR A PARTICULAR PURPOSE, STATUTORY OR OTHERWISE. SOME PROVINCES DO NOT ALLOW THE EXCLUSION OF CERTAIN IMPLIED WARRANTIES OR CONDITIONS, OR LIMITATIONS ON HOW LONG AN IMPLIED WARRANTY OR CONDITION LASTS. THEREFORE, THE FOREGOING EXCLUSIONS AND LIMITATIONS MAY NOT APPLY TO YOU.

WE DO NOT ACCEPT LIABILITY BEYOND THE REMEDIES PROVIDED FOR IN THIS WARRANTY STATEMENT OR FOR SPECIAL, INDIRECT, CONSEQUENTIAL, OR INCIDENTAL DAMAGES, INCLUDING, WITHOUT LIMITATION, ANY LIABILITY FOR THIRD-PARTY CLAIMS AGAINST YOU FOR DAMAGES, FOR PRODUCTS NOT BEING AVAILABLE FOR USE, OR FOR LOST DATA OR LOST SOFTWARE. OUR LIABILITY WILL BE NO MORE THAN THE AMOUNT YOU PAID FOR THE PRODUCT THAT IS THE SUBJECT OF A CLAIM. THIS IS THE MAXIMUM AMOUNT FOR WHICH WE ARE RESPONSIBLE.

SOME PROVINCES DO NOT ALLOW THE EXCLUSION OR LIMITATION OF SPECIAL, INDIRECT, INCIDENTAL, OR CONSEQUENTIAL DAMAGES, SO THE ABOVE LIMITATION OR EXCLUSION MAY NOT APPLY TO YOU.

How long does this limited warranty last?

This limited warranty lasts for the time period indicated on your packing slip or invoice, except that the limited warranty on Dell-branded batteries lasts only 1 year and the limited warranty on the lamps for Dell-branded projectors lasts only 90 days. The limited warranty begins on the date of the packing slip or invoice. The warranty period is not extended if we repair or replace a warranted product or any parts. Dell may change the terms and availability of limited warranties, at its discretion, but any changes will not be retroactive (that is, the warranty terms in place at the time of purchase will apply to your purchase).

What do I do if I need warranty service?

Before the warranty expires, please call us at the relevant number listed in the following table. Please also have your Dell Service Tag or order number available.

Individual Home Consumers; Home Office and Small Business Customers:	Canada Only
Technical Support and Customer Service	1-800-847-4096
Medium, Large, and Global Commercial Customers; Government, Education, and Healthcare Customers; and Value-Added Resellers (VARs):	
Technical Support	1-800-387-5757
Customer Service	1-800-326-9463
Government or Education Customers, or Individual Home Consumers who purchased through an Employee Purchase Program:	
Technical Support	1-800-387-5757
Customer Service	1-800-326-9463 (Extension 8221 for Individual Consumers)
Dell-Branded Memory	1-888-363-5150

What will Dell do?

During the 90 days of the 90-day limited warranty and the first year of all other limited warranties: During the 90 days of the 90-day limited warranty and the first year of all other limited warranties, we will repair any Dell-branded hardware products returned to us that prove to be defective in materials or workmanship. If we are not able to repair the product, we will replace it with a comparable product that is new or refurbished.

When you contact us, we will issue a Return Material Authorization Number for you to include with your return. You must return the products to us in their original or equivalent packaging, prepaid shipping charges, and insure the shipment or accept the risk if the product is lost or damaged in shipment. We will return the repaired or replacement products to you. We will pay to ship the repaired or replaced products to you if you use an address in Canada. Otherwise, we will ship the product to you freight collect.

If we determine that the problem is not covered under this warranty, we will notify you and inform you of service alternatives that are available to you on a fee basis.

NOTE: Before you ship the product(s) to us, make sure to back up the data on the hard drive(s) and any other storage device(s) in the product(s). Remove any confidential, proprietary or personal information, removable media, such as floppy disks, CDs, or PC Cards. We are not responsible for any of your confidential, proprietary or personal information; lost or corrupted data; or damaged or lost removable media.

During the remaining years following the first year of all limited warranties: We will replace any defective part with new or refurbished parts, if we agree that it needs to be replaced. When you contact us, we will require a valid credit card number at the time you request a replacement part, but we will not charge you for the replacement part as long as you return the original part to us within 30 days after we ship the replacement part to you. If we do not receive the original part within 30 days, we will charge to your credit card the then-current standard price for that part.

We will pay to ship the part to you if you use an address in Canada. Otherwise, we will ship the part freight collect. We will also include a prepaid shipping container with each replacement part for your use in returning the replaced part to us.

NOTE: Before you replace parts, make sure to back up the data on the hard drive(s) and any other storage device(s) in the product(s). We are not responsible for lost or corrupted data.

What if I purchased a service contract?

If your service contract is with Dell, service will be provided to you under the terms of the service contract. Please refer to that contract for details on how to obtain service. Dell's service contracts can be found online at www.dell.ca or by calling Customer Care at 1-800-847-4096. If you purchased through us a service contract with one of our third-party service providers, please refer to that contract (mailed to you with your packing slip or invoice) for details on how to obtain service.

How will you fix my product?

We use new and refurbished parts made by various manufacturers in performing warranty repairs and in building replacement parts and systems. Refurbished parts and systems are parts or systems that have been returned to Dell, some of which were never used by a customer. All parts and systems are inspected and tested for quality. Replacement parts and systems are covered for the remaining period of the limited warranty for the product you bought. Dell owns all parts removed from repaired products.

May I transfer the limited warranty?

Limited warranties on systems may be transferred if the current owner transfers ownership of the system and records the transfer with us. The limited warranty on Dell-branded memory may not be transferred. You may record your transfer by going to Dell's website:

- For Canada-purchased computers (in-country transfers) and to transfer from one customer to another, go to www.dell.ca/ca/en/gen/topics/segtopic_ccare_nav_013_ccare.htm
- For out-of-country transfers (outside of the original country of purchase), go to www.dell.com/us/en/biz/topics/sbtopic_ccare_nav_016_ccare.htm

If you do not have Internet access, call Dell at 1-800-847-4096 (Home Consumer customers) or 1-800-326-9463 (Corporate Commercial or Government customers).

"Total Satisfaction" Return Policy (Canada Only)

If you are an end-user customer who bought new products directly from Dell, you may return them to Dell up to 30 days after you receive them for a refund or credit of the product purchase price. If you are an end-user customer who bought reconditioned or refurbished products from Dell, you may return them to Dell within 14 days after the date on the packing slip or invoice for a refund or credit of the product purchase price. In either case, the refund or credit will not include any shipping and handling charges shown on your packing slip or invoice and will be subject to a fifteen percent (15%) restocking fee, unless otherwise prohibited by law. If you are an organization that bought the products under a written agreement with Dell, the agreement may contain different terms for the return of products than specified by this policy.

To return products, you must call Dell Customer Service at 1-800-847-4096 to receive a Credit Return Authorization Number. To expedite the process of your refund or credit, Dell expects you to return the products to Dell in their original packaging within 5 days of the date that Dell issues the Credit Return Authorization Number. You must also prepay shipping charges and insure the shipment or accept the risk of loss or damage during shipment. You may return software for a refund or credit only if the sealed package containing the floppy disk(s) or CD(s) is unopened. Returned products must be in as-new condition, and all of the manuals, floppy disk(s), CD(s), power cables, and other items included with a product must be returned with it. For customers who want to return, for refund or credit only, either application or operating system software that has been installed by Dell, the whole system must be returned, along with any media and documentation that may have been included in the original shipment.

The "Total Satisfaction" Return Policy does not apply to Dell | EMC storage products. It also does not apply to products purchased through Dell's Software and Peripherals division. For those products, please instead refer to Dell's Software and Peripheral's then-current return policy (see the following section, "Dell Software and Peripherals [Canada Only]").

Dell Software and Peripherals (Canada Only)

Third-Party Software and Peripherals Products

Similar to other resellers of software and peripherals, Dell does not warrant third-party products. Third-party software and peripheral products are covered by the warranties provided by the original manufacturer or publisher only. Third-party manufacturer warranties vary from product to product. Consult your product documentation for specific warranty information. More information may also be available from the manufacturer or publisher.

While Dell offers a wide selection of software and peripheral products, we do not specifically test or guarantee that all of the products we offer work with any or all of the various models of Dell computers, nor do we test or guarantee all of the products we sell on the hundreds of different brands of computers available today. If you have questions about compatibility, we recommend and encourage you to contact the third-party software and peripheral product manufacturer or publisher directly.

Dell-Branded Peripheral Products

Dell does provide a limited warranty for new Dell-branded peripheral products (products for which Dell is listed as the manufacturer) such as monitors, batteries, memory, docking stations, and projectors. To determine which limited warranty applies to the product you purchased, see the Dell packing slip or invoice and/or the product documentation that accompanied your product. Descriptions of Dell's limited warranties are described in preceding sections.

Return Policy

If you are an end-user customer who bought Dell Software and Peripherals products directly from a Dell company, you may return Dell Software and Peripherals products that are in as-new condition to Dell up to 30 days from the date on the packing slip or invoice for a refund of the product purchase price if already paid. This refund will not include any shipping and handling charges shown on your packing slip or invoice; you are responsible for those.

To return products, you must call Dell Customer Service at 1-800-387-5759 to receive a Credit Return Authorization Number. You must ship the Dell Software and Peripherals products back to Dell in their original manufacturer's packaging (which must be in as-new condition), prepay shipping charges, and insure the shipment or accept the risk of loss or damage during shipment.

To qualify for refund or replacement, returned products must be in as-new condition, software products must be unopened, and all of the manuals, floppy disk(s), CD(s), power cables, and other items included with a product must be returned with it.

1-Year End-User Manufacturer Guarantee (Latin America and the Caribbean Only)

Guarantee

Dell Computer Corporation ("Dell") warrants to the end user in accordance with the following provisions that its branded hardware products, purchased by the end user from a Dell company or an authorized Dell distributor in Latin America or the Caribbean, will be free from defects in materials, workmanship, and design affecting normal use, for a period of 1 year from the original purchase date. Products for which proper claims are made will, at Dell's option, be repaired or replaced at Dell's expense. Dell owns all parts removed from repaired products. Dell uses new and reconditioned parts made by various manufacturers in performing repairs and building replacement products.

Exclusions

This Guarantee does not apply to defects resulting from: improper or inadequate installation, use, or maintenance; actions or modifications by unauthorized third parties or the end user; accidental or willful damage; or normal wear and tear.

Making a Claim

Claims must be made in Latin America or the Caribbean by contacting the Dell point of sale within the guarantee period. The end user must always supply proof of purchase, indicating name and address of the seller, date of purchase, model and serial number, name and address of the customer, and details of symptoms and configuration at the time of malfunction, including peripherals and software used. Otherwise, Dell may refuse the guarantee claim. Upon diagnosis of a warranted defect, Dell will make arrangements and pay for ground freight and insurance to and from Dell's repair/replacement center. The end user must ensure that the defective product is available for collection properly packed in original or equally protective packaging together with the details listed above and the return number provided to the end user by Dell.

Limitation and Statutory Rights

Dell makes no other warranty, guarantee or like statement other than as explicitly stated above, and this Guarantee is given in place of all other guarantees whatsoever, to the fullest extent permitted by law. In the absence of applicable legislation, this Guarantee will be the end user's sole and exclusive remedy against Dell or any of its affiliates, and neither Dell nor any of its affiliates shall be liable for loss of profit or contracts, or any other indirect or consequential loss arising from negligence, breach of contract, or howsoever.

This Guarantee does not impair or affect mandatory statutory rights of the end user against and/or any rights resulting from other contracts concluded by the end user with Dell and/or any other seller.

Dell World Trade LP

One Dell Way, Round Rock, TX 78682, USA

Dell Computadores do Brasil Ltda (CNPJ No. 72.381.189/0001-10)

Avenida Industrial Belgraf, 400
92990-000 - Eldorado do Sul – RS - Brasil

Dell Computer de Chile Ltda

Coyancura 2283, Piso 3- Of.302,
Providencia, Santiago - Chile

Dell Computer de Colombia Corporation

Carrera 7 #115-33 Oficina 603
Bogota, Colombia

Dell Computer de Mexico SA de CV

Paseo de la Reforma 2620 - 11° Piso
Col. Lomas Altas
11950 México, D.F.

Glossary

802.11 (Wi-Fi) — A wireless technology standard for mid-range networking devices that allows for enabled devices to automatically recognize each other.

BLUETOOTH® WIRELESS TECHNOLOGY — A wireless technology standard for short-range (10 m [30 ft]) networking devices that allows for enabled devices to automatically recognize each other.

COMPACTFLASH CARD — A removable card that is used to expand the capabilities of a device. Common types of CompactFlash cards include memory and wireless cards.

CRADLE — A device that allows your handheld device to synchronize with a computer, recharge its battery, and run on AC power.

DHCP — dynamic host configuration protocol — A communication protocol that allows network administrators to manage and automate the assignment of Internet Protocol addresses to computers in a network.

IMAP — Internet message access protocol — A standard client/server protocol that allows you to access your e-mail from your device. Using IMAP, you can store and browse your e-mail on the ISP's server.

INFRARED SENSOR — A port that allows you to transfer data between the computer and infrared-compatible devices without using a cable connection.

ISP — Internet service provider — A company that allows you to access its host server to connect directly to the Internet, send and receive e-mail, and access websites. The ISP typically provides you with a software package, username, and access phone numbers for a fee.

LAN — local area network — A computer network covering a small area. A LAN usually is confined to a building or a few nearby buildings. A LAN can be connected to another LAN over any distance via telephone lines and radio waves to form a wide area network (WAN).

PIM — personal information manager — A program that stores and organizes your personal information, such as Calendar, Contacts, Messaging, and Tasks.

POP3 — post office protocol 3 — A standard client/server protocol that allows you to access your e-mail on the ISP's server. Using POP3, you must download your e-mail to your device to view and browse your messages.

RAM — random-access memory — The primary temporary storage area for program instructions and data. Any information stored in RAM is lost when you perform a reset.

RAS — remote access server — A type of server that allows users to access a network from a remote location.

ROM — read-only memory — Memory that stores data and programs that cannot be deleted or written to by the device. ROM, unlike RAM, retains its contents after you perform a reset. Some programs essential to the operation of your device reside in ROM.

SDRAM — synchronous dynamic random-access memory — A type of DRAM that is synchronized with the optimal clock speed of the microprocessor.

SECURE DIGITAL MEMORY CARD — A type of removable memory commonly used in digital cameras, handheld devices, cell phones, and other devices. Secure Digital memory cards are approximately the size of a postage stamp.

SERIAL CONNECTOR — An I/O port often used to connect devices such as a handheld digital device or digital camera to your computer.

SMS — short message service — A service that is capable of sending short messages to wireless devices.

SMTP — simple mail transfer protocol — A type of protocol used for sending and receiving e-mail. SMTP is typically coupled with POP3 or IMAP.

SYNC CABLE — A cable through which you can connect a handheld device to a computer to transfer or synchronize files.

SYNCHRONIZATION — An automated process that replaces the files in one location with the most updated files from another location. For example, you can synchronize the files on your computer with the files on your handheld device.

TCP/IP — transmission control protocol/Internet protocol — The basic communication language of the Internet. TCP/IP can also be used as a communication protocol in an intranet or extranet.

USB — universal serial bus — A hardware interface for a low-speed device such as a USB-compatible keyboard, mouse, joystick, scanner, set of speakers, printer, broadband devices (DSL and cable modems), imaging devices, or storage devices. Devices are plugged directly into a 4-pin socket on your computer or into a multiport hub that plugs into your computer. USB devices can be connected and disconnected while the computer is turned on, and they can also be daisy-chained together.

VPN — virtual private network — A set of communication protocols that allows remote users to securely access a network.

WAP — wireless application protocol — A standardization for the way that wireless devices access the Internet.

Index

A

- ActiveSync
 - installing, 86
- appointments
 - scheduling, 88
- audio
 - Media player, 126
 - notifications, 98

B

- battery
 - charging, 50
 - main, 48
 - using and installing, 48
- block recognizer, 74
- Bluetooth
 - settings, 83
- buttons
 - about, 55
 - Calendar, 46
 - Contacts, 46
 - Home, 46
 - locations, 45
 - navigator, 46
 - program buttons, 66
 - record, 46
 - reset, 47

C

- Calendar
 - about, 88
 - appointments, 88
 - meeting requests, 89
- command bar, 68
- communicating
 - with other devices, 101
- CompactFlash
 - about, 61
 - installing, 62
 - slot, 45
- computer
 - connecting to, 56, 61
- Contacts
 - about, 90
 - creating, 90
 - finding, 91
- copy
 - pop up menus, 69
- cradle
 - connecting to a computer, 56

D

data

- backing up, 71

delete

- pop-up menus, 69

delete a file in Excel, 122

delete a file in PowerPoint, 124

delete a file in Word, 120

disconnecting

- dial-up connection, 111
- from a cable or cradle, 111
- from a network, 111
- infrared sensor, 111

drawing

- creating, 79

E

editing

- written text, 76

e-mail

- composing messages, 96
- connecting to a server, 94, 112
- message list, 95
- Messaging, 93
- organizing, 97
- synchronizing, 94

ethernet connection, 110

Excel

- about, 121
- delete files, 122
- tips, 122

Excel Mobile, 121

expansion slots

- CompactFlash, 61
- locations, 45

F

File Download Security
Warning, 133

files

- backing up, 71
- finding and organizing, 70

H

Hard Reset, 64

help

- ActiveSync Help, 112
- finding, 112

I

icons

- program, 67
- status, 65

infrared

- using, 108

input panel, 72

Internet

- connecting to, 101

- Internet Explorer
 - about, 126
 - browsing the web, 128
 - favorite links, 128
 - mobile favorites, 127-128
- Internet Explorer Mobile, 126

K

- keyboard
 - soft, 73

L

- letter recognizer, 74

M

- Media Player
 - about, 126
- meeting requests
 - creating, 89
- memory
 - conserving, 128
- Messaging
 - about, 93
- microphone
 - recording a message, 80
- Microsoft® Windows Mobile™
 - Version 5.0, 65
- mobile favorites, 127
- modem connection, 109

- MSN Messenger
 - setting up, 125
 - working with contacts, 125

- My Text
 - inserting, 81

N

- navigation bar, 68
- network
 - connecting to, 101
- Notes
 - creating, 93
- notifications
 - about, 98

P

- Pocket MSN
 - about, 124
- Pocket Outlook
 - about, 87
- pop-up menus, 69
- PowerPoint
 - about, 123
 - delete files, 124
- PowerPoint Mobile, 123
- print-style text
 - converting written text to, 74-75

- programs
 - accessing, 66
 - adding and removing, 115
 - adding programs using
 - ActiveSync, 115
 - Calendar, 88
 - Contacts, 90
 - downloading, 116
 - Excel Mobile, 121
 - Media Player, 126
 - Messaging, 93
 - Notes, 93
 - Pocket Internet Explorer, 126
 - Pocket MSN, 124
 - Pocket Outlook, 87
 - PowerPoint Mobile, 123
 - removing, 117
 - Start menu, 117
 - Switcher Bar, 67
 - Tasks, 91
 - Word Mobile, 119

projector, 61

R

- recording
 - voice messages, 80
- reminders. *See* notifications
- reset
 - button, 47

S

safety instructions, 11

- Secure Digital card slot
 - installing cards, 63
 - location, 45

Service Tag, 16, 50

- settings
 - Connections tab, 83
 - Personal tab, 82
 - System tab, 82

Soft Reset, 63

software. *See* programs

specifications, 135

- stylus
 - using, 55

Switcher Bar, 67

- sync cable
 - connecting to a computer, 60

- synchronizing
 - with your computer, 56

T

- Tasks
 - about, 91
 - creating, 91

text

- converting written text to
 - print-style text, 74-75
- editing, 76
- input panel, 72
- typing, 73
- written, 74-75

transcriber, 75

U

Unpacking Your Device, 43

Using Your Axim, 52

V

video

Media Player, 126

VPN connection, 111

W

warranty, 141, 149

Windows Media Player, 126

Word

about, 119

delete files, 120

Word Mobile, 119

writing

block recognizer, 74

converting written text to
print-style text, 74-75

drawing, 79

letter recognizer, 74

on the screen, 75

transcriber, 75

