

# TASCAM

TEAC Professional Division

D00998801A

# MP-VT1

## MP3 Music & Voice Trainer

### OWNER'S MANUAL



# Contents

<b>1 – Introduction</b> .....	3
Supplied accessories .....	3
Manual conventions .....	3
Precautions for placement and use .....	3
Beware of condensation .....	3
About the power supply .....	4
Recharging the battery .....	4
Recharging with a computer .....	4
Recharging with a PS-P520 AC adapter (sold separately) .....	4
Turning the power on and off .....	4
To turn the MP-VT1 power on .....	4
To turn the MP-VT1 power off .....	4
<b>2–Part names and functions</b> .....	5
Top Panel .....	5
Front Panel .....	6
Right Side Panel .....	6
Left Side Panel .....	7
Back Panel .....	7
Home screen .....	8
<b>3 – Connections &amp; MP3 Transfer</b> .....	10
Making connections .....	10
Connecting headphones or speakers .....	10
Connecting a mic .....	10
Connecting to a computer .....	11
Disconnecting from a computer .....	11
Moving MP3 files to the the MP-VT1 .....	11
Copying tracks from a computer .....	11
Preparing MP3 files on a computer .....	11
<b>4 – Menus &amp; Settings</b> .....	12
Menu items .....	12
Menu overview .....	12
Using the Menus .....	12
<b>5 – Playing and Selecting Tracks</b> .....	14
Basic track playback functions .....	14
Playing a track .....	14
Pausing a track .....	14
Selecting a track .....	14
Searching a track .....	14
Adjusting the volume .....	14
Selecting a track to play .....	14
Using the Browse screen to select tracks .....	14
Setting the play area .....	15
Using the playlist .....	16
Adding tracks to the playlist .....	16
Editing the playlist .....	16
ALL CLR: Remove all tracks from the playlist .....	16
DELETE: Remove one track from the playlist .....	16
MOVE: Change the order of tracks .....	17
Repeat and single-track playback (PLAY MODE) .....	17
<b>6 – Practice Functions</b> .....	18
Changing playback pitch and tempo .....	18
Changing the tempo (TEMPO) .....	18
Change tempo without changing pitch (VSA) .....	18
Change key without changing tempo (KEY) .....	18
Canceling mic sounds (VOICE CANCEL) .....	18
Repeat playback of a selected loop .....	19
Connecting a mic to practice .....	19
Practicing with tracks as they play .....	19
Using the metronome (METRONOME) .....	19
Turning the metronome ON and OFF .....	19
<b>7 – Using Effects</b> .....	20
<b>8 – Using the Tuner</b> .....	21
Chromatic tuner mode .....	21
Oscillator mode (OSC.) .....	21
<b>9 – Setup Menu Options</b> .....	22
Cue and review speed .....	22
Automatic power off .....	22
Automatically turning off the backlight .....	22
Display contrast .....	22
Backlight brightness .....	22
Initializing the unit .....	22
Formatting the unit quickly .....	23
Formatting the unit completely .....	23
<b>10 – Using the Information Pages</b> .....	24
File information page (FILE) .....	24
Memory information page (MEMORY) .....	24
System information page (SYSTEM) .....	24
<b>11 – Effect Lists</b> .....	25
Effect preset list .....	25
<b>12 – Messages</b> .....	26
<b>13 – Recycling the Battery</b> .....	28
How to remove the rechargeable battery .....	28
<b>14 – Specifications</b> .....	29
Rated audio input and output .....	29
Audio performance .....	29
Other specifications .....	29
Minimum computer requirements .....	29
Stored settings .....	30
Dimensions .....	30

# 1 – Introduction

Thank you very much for purchasing the TASCAM MP-VT1 MP3 Music & Voice Trainer. Please read this Owner's Manual carefully before using the unit in order to maximize your use of all its features. We hope that you will enjoy using this trainer for many years to come.

The MP-VT1 is a flash memory (1 GB) music player that has been optimized for voice and instrument practice. If you are trying to learn a part that is too difficult to catch at ordinary playback speed, you can use this trainer to slow the playback to a speed that makes learning the notes easier.

Furthermore, the dedicated mic input allows you to use the unit's built-in effects as you sing or play an instrument along with the music. Using a computer, you can also transfer music as MP3s easily from audio CDs and other sources to the MP-VT1.

---

## Supplied accessories

---

In addition to this manual, the following accessories are supplied.

- Quick Start Guide.....1
- Mini-B USB cable .....1
- Warranty card.....1

Please contact the store where you purchased this unit if any of these accessories are missing.

### NOTE

*We recommend that you keep the original box and packing materials for transportation of this unit.*

---

## Manual conventions

---

In this manual, we use the following conventions:

- Controls and keys on the MP-VT1 are written like this: **MENU**.
- Messages shown on the display are written like this:  
Are you sure? .

- If a fixed onscreen indicator (i.e. one which cannot change) is shown, it is written like this: **VSA**.
- We use the term “key” to describe the push-button controls on the MP-VT1.

---

## Precautions for placement and use

---

The MP-VT1 may be used in most areas, but to maintain top performance, and prolong operating life, observe the following notes, precautions and environmental conditions:

- Avoid exposing it to extremes of temperature and humidity and avoid mechanical shocks and vibration.
- Keep the unit away from strong magnetic fields (TV sets, computer monitors, large electric motors, etc.).
- The nominal temperature should be between 0°C and 40°C (32°F and 104°F).
- Relative humidity should be 30 to 80 percent.

- As the unit may become hot during operation, always leave sufficient space above the unit for ventilation. Do not install this unit in a confined space such as a bookcase, and do not put anything on top of the unit.
- Avoid installing this unit on top of any heat-generating electrical device such as a power amplifier.
- Make sure that the unit is mounted in a level position for correct operation.
- The voltage supplied to the unit should match the voltage as printed on the rear panel. If you are in any doubt regarding this matter, consult an electrician.

---

## Beware of condensation

If the unit is moved from a cold to a warm place, or used after a sudden temperature change, there is a danger of condensation; vapor in the air could condense on the internal mechanism, making correct operation impossible. To prevent this, or if this occurs, let the player sit for one or two hours at the new room temperature before using.

# 1 – Introduction

## About the power supply

The MP-VT1 uses a built-in lithium ion battery that can be recharged by connecting the unit to a computer with the included USB cable. You can also use an AC adapter (sold separately) to power the unit and recharge the battery.

When new, the battery charge lasts about 8 hours.

### NOTE

*When you purchase the MP-VT1, the battery is not fully charged. Please charge it before use or use it with an AC adapter (sold separately).*

## Recharging the battery

### Recharging with a computer

To charge the battery using a computer, connect the unit to the computer using the included USB cable and turn the computer on if it is off and not transmitting power to the unit.

Connect the MP-VT1 directly to the computer. Recharging cannot be guaranteed if a USB hub is used between the computer and the MP-VT1.

Recharging takes about 6 hours (when the MP-VT1 power is OFF).

If the MP-VT1's power is turned ON when it is being recharged from a computer, it is automatically treated by the computer as a connected USB drive. (See "Connecting to a computer" on page 11.)

### Recharging with a PS-P520 AC adapter (sold separately)

Connect the AC adapter to the MP-VT1's DC IN 5V jack and plug the adapter into a working power outlet.

Recharging takes about 3 hours.

You can use the MP-VT1 when it is connected to an AC adapter and recharging.

Furthermore, the recharging time is the same whether the MP-VT1 power is ON or OFF.

### NOTE

*The indicator at the right side of the display shows the battery's charging status. It lights orange while charging and goes out when charging is complete.*

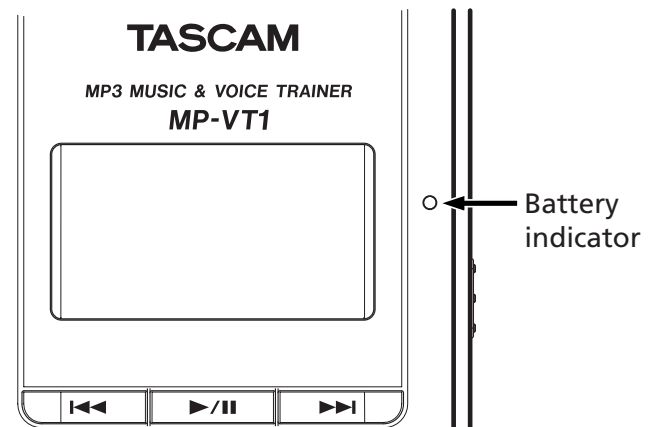

## Turning the power on and off

### To turn the MP-VT1 power on

Slide the **POWER** switch in the direction of the arrow and hold it until TASCAM appears on the screen. Release the switch.

The MP-VT1 starts and the home screen appears.

### To turn the MP-VT1 power off

Slide the **POWER** switch in the direction of the arrow and hold it until Trainer series appears on the screen. Release the switch. The MP-VT1 then shuts down.

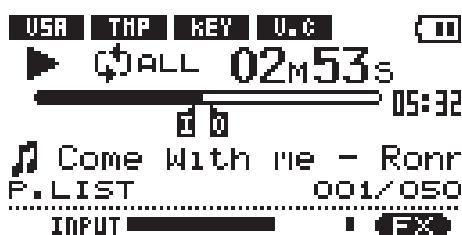

## 2 – Part names and functions

### Top Panel

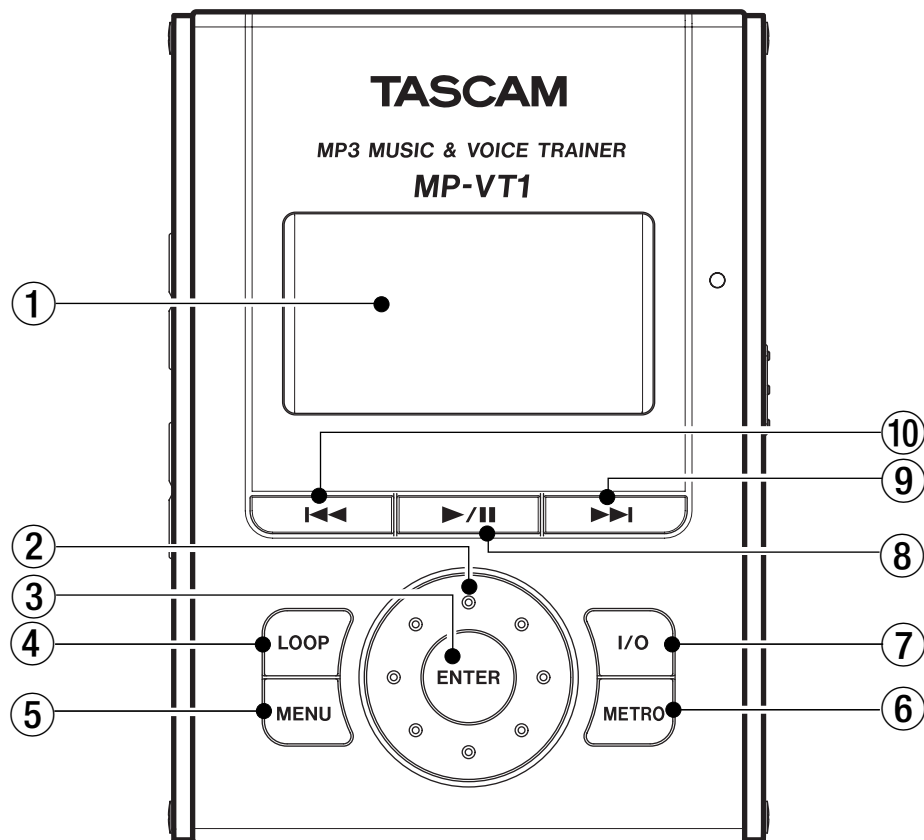

#### ① Display (LCD)

The display shows the Home screen and the menus related to using the metronome and making operation and effect settings. (See “Home screen” on page 8.)

#### ② Wheel

Use to select items and change values when using menus and the effect section.

#### ③ ENTER key

Press this key to confirm a selection when using menus and the effect section and to advance to the next screen.

#### ④ LOOP key

Press this key to start loop playback mode and automatically repeat playback of a section of a song that you select. The **I↔O** indicator appears on the display. (See “Repeat playback of a selected loop” on page 19.)

Press this key again to exit loop playback mode.

#### ⑤ MENU key

When the home screen is open, press this key to open the **MENU** screen.

During use of menus or the effect settings screen, press this key to return to the previous screen. Repeated presses eventually returns to the home screen.

#### ⑥ METRO key

Press this key to open the **METRONOME** screen. When the **METRONOME** screen is open, press this key to return to the home screen.

#### ⑦ I/O key

Use this key to set the IN and OUT points to set a section for loop playback.

When both IN and OUT points are set, pressing this key again will clear these points. (See “Repeat playback of a selected loop” on page 19.)

#### ⑧ ►/|| key

Press this key to start playback or to pause playback at the current position.

When the **METRONOME** screen is open, press this to start and stop the metronome.

#### ⑨ ►► key

Press this key to skip to the next track.

Press and hold to search forward.

#### ⑩ ◀◀ key

Press this key to return to the beginning of a track that is playing or paused.

When at the beginning of a track, press to skip to the previous track.

Press and hold to search backward.

## 2 – Part names and functions

### Front Panel

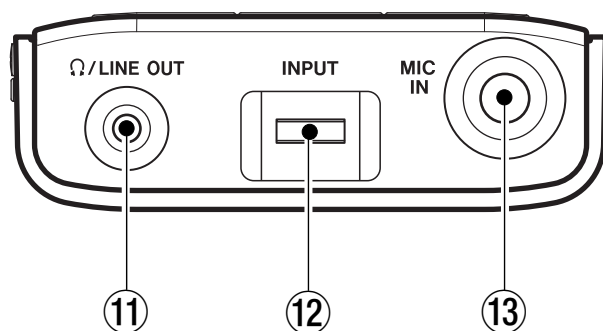

⑪ Ω / LINE OUT jack (stereo minijack)

Connect headphones to this jack to hear the playing tracks and the sound of a connected mic.

This jack can also be used as a line output jack.

⑫ INPUT volume

Use to adjust the input level of the Mic IN jack.

⑬ MIC IN jack (standard phone jack)

Connect a mic or a contact mic attached to an instrument.

### Right Side Panel

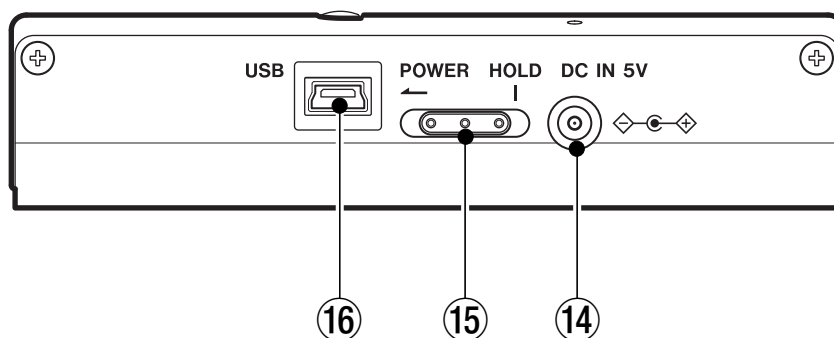

⑭ DC IN 5V jack

Connect an AC adapter (TASCAM PS-P520, sold separately).

⑮ POWER switch

Slide and hold this switch in the direction of the arrow (to the left) to turn the power ON and OFF.

Slide it to the right to engage the HOLD function. When set to HOLD, all keys are disabled.

⑯ USB port

Connect the included USB cable to this port and your computer.

**NOTE**

*Trouble-free use of a USB hub cannot be guaranteed. If you experience trouble using a USB hub, connect the unit directly with the computer.*

## 2 – Part names and functions

### Left Side Panel

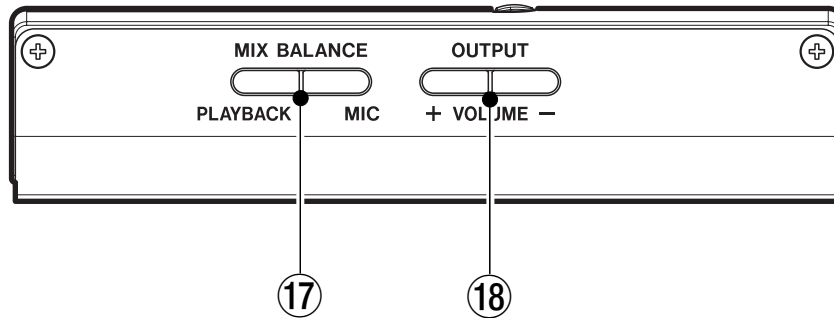

#### ⑰ MIX BALANCE (MIC, PLAYBACK) keys

Use these keys to adjust the balance between the volume of the mic connected to the **MIC IN** jack and the playing track. During adjustment, the balance status is shown at the bottom of the display.

Press the **MIC** key to increase the relative level of the mic, and the **PLAYBACK** key to increase the relative level of the playing track.

During metronome playback, these keys adjust the mic and metronome balance with the **PLAYBACK** key increasing the metronome volume relatively.

#### ⑱ OUTPUT VOLUME (+, -) keys

Use to adjust the overall signal level sent from the **Ω/LINE OUT** jack.

During adjustment, the output volume is shown at the bottom of the display.

### Back Panel

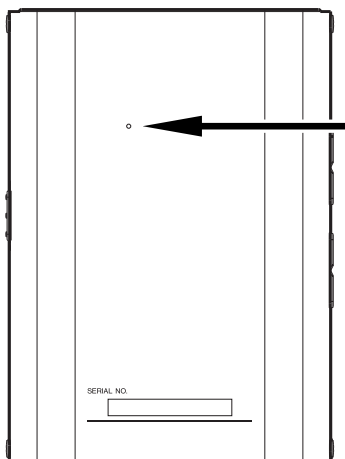

#### Reset hole

If the MP-VT1 starts to operate incorrectly, insert the end of a paper clip or similar object into this hole to press the System Reset Button inside. Pressing this button turns the power OFF.

#### **CAUTION**

*Do not press the System Reset Button if the unit is operating normally.*

# 2 – Part names and functions

## Home screen

During normal operation the Home screen appears on the display. The following explanation is for the Home screen.

### NOTE

When using menus or the built-in metronome dedicated screens are opened. See other sections for explanation of menu and metronome screens.

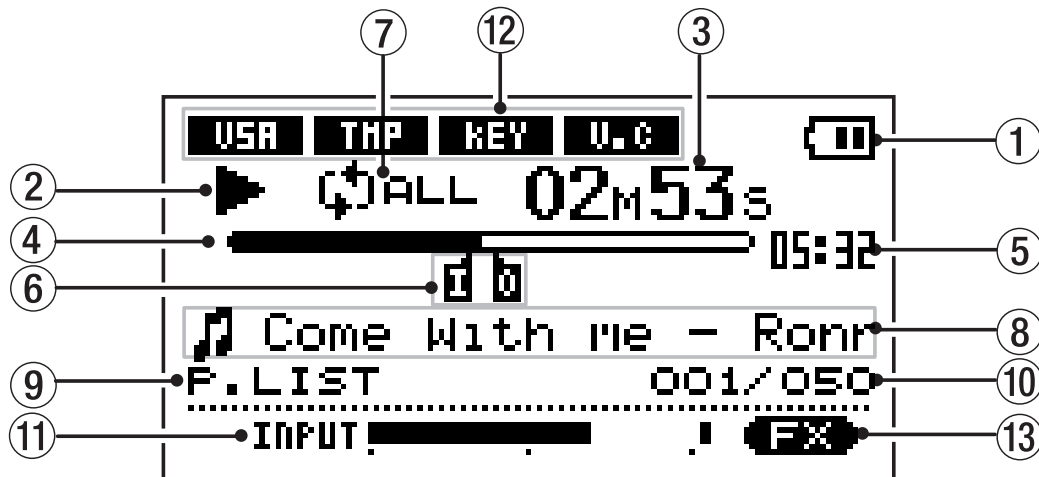

### ① Power

The battery indicator appears when the built-in lithium ion battery is used. Three bars show a full battery. This indicator blinks when the battery needs to be recharged.

### ② Player operation indicators

These indicators show what the player is doing.

- ▶ Track is playing
- || Track is paused
- Track stopped at beginning
- ▶▶ Fast forwarding
- ◀◀ Fast rewinding
- ▶▶▶ Skipping to next track
- ◀◀◀ Skipping to previous track

### ③ Elapsed time (00m00s)

The elapsed time (minutes: seconds) appears during track playback.

### ④ Playback position bar

This bar shows the current playback position. The dark bar extends from the left as playback proceeds.

### ⑤ Remaining time

The remaining time (minutes: seconds) appears during track playback.

### ⑥ Loop IN point and OUT point markers

Shows the loop playback IN and OUT points.

When the IN point is set, I appears below the playback position bar at the position relative to the time of the IN point.

When the OUT point is set, O appears below the playback position bar at the position relative to the time of the OUT point.

### ⑦ Loop/repeat setting status indicators

The following indicators appear according to the playback settings.

- ↪ SINGLE Current track plays and then playback stops
- ↻ 1 Current track plays repeatedly
- ↻ ALL All tracks in the play area play repeatedly
- I↔O Playback loops between IN and OUT points

### ⑧ Track information

Tag information or file name appears during playback.

If there is ID3 tag information, the Title information will be shown, but if not, the file name will be shown.



## 2 – Part names and functions

### ⑨ Play area

The currently selected play area appears.

**ALL** All files in the **MUSIC** folder

**FOLDER** Files in a subfolder of the **MUSIC** folder

**P.LIST** Files added to the playlist

Playback track number/total number of tracks

The current track number and the total number of tracks in the selected play area appears.

### ⑩ Track number

Shows the current track number/number of tracks in the selected play area.

### ⑪ INPUT level meter

Level of the mic signal entering the **Mic IN** jack appears.

### ⑫ Status of playback control functions

The status of each playback control function (VSA, tempo, key, voice cancel) is shown.

When a function is ON, its indicator appears with light colored letters on a dark background.

### ⑬ Effect setting status

Shows whether the effects are ON or OFF. When the effect function is ON, its indicator appears with light colored letters on a dark background.

# 3 – Connections & MP3 Transfer

## Making connections

### Connecting headphones or speakers

You can connect headphones or a monitoring system (powered speakers, amplifier/speaker system, etc.) to the MP-VT1  $\Omega$ /LINE OUT jack.

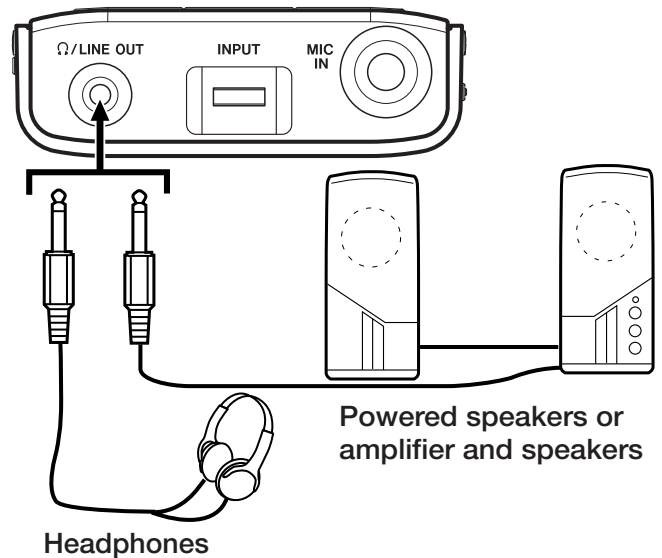

### Connecting a mic

Using the MP-VT1's mic input jack and built-in mic effects, you can create a variety of effects with just the MP-VT1. You can also sing or play an instrument along with an MP3 track on the unit. (See the “Practice Functions” chapter on page 18 and the “Using Effects” chapter on page 20.)

The **INPUT** level meter appears at the bottom of the home screen. Use this to confirm input and adjust the level of the mic signal. If the input level is too high, the dot at the far right end of the bar will stay lit briefly. If the input level is low, then the meter bar will extend only a short distance from the left.

Watch this meter as you adjust the **INPUT** volume to set the input level so that it is neither too high or too low.

The mic sound is output through the  $\Omega$ /LINE OUT jack.

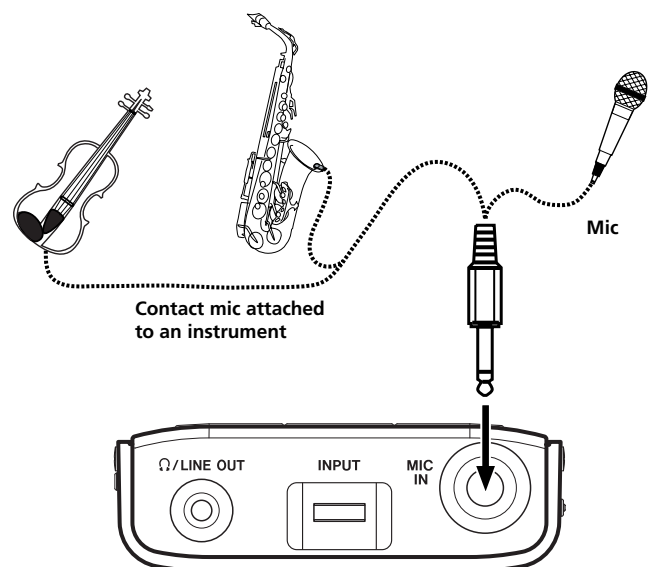

# 3 – Connections & MP3 Transfer

## Connecting to a computer

By connecting the MP-VT1 to a computer, you can copy music files (in MP3 format) from the computer to the MP-VT1, erase files on the MP-VT1 and edit folders.

To transfer music files stored on a computer to the MP-VT1, use the included USB cable to connect the USB port on the unit to a computer USB port.

connected... USB appears on the MP-VT1 screen. On the computer, you should find the unit shown as an external drive named “MP-VT1.”



### NOTE

*When shipped from the factory, a copy of this Owner's Manual is stored in the MP-VT1 drive in PDF format in the MANUAL folder. If you erase it, please make a backup copy for future reference.*

## Disconnecting from a computer

When disconnecting the MP-VT1 from a computer, follow the procedures for your computer operating system to dismount an external drive, and then disconnect the USB cable.

The MP-VT1 automatically restarts.



## Moving MP3 files to the the MP-VT1

### Copying tracks from a computer

The MP-VT1 can play back MP3 (MPEG1 Audio Layer III) format files. (See “File information page” on page 24.)

MP3 files are transferred from a computer by the USB cable.

### NOTE

*RIFF format MP3 files with .wav extensions are not supported. 44.1 kHz is the only supported sampling frequency. MP3 files with other frequencies, including 48 kHz and 32 kHz, are not supported.*

### Preparing MP3 files on a computer

Use a software application to convert tracks from a CD or other source into MP3 files on the computer.

### NOTE

*Most music importing software (e.g. iTunes) can convert tracks from other formats to MP3s. However, this software can probably also convert and import into other formats. Please confirm that your software is set to import tracks in MP3 format.*

Procedures to copy tracks from a computer

- 1 Connect the MP-VT1 and the computer. (See “Connecting to a computer” above.)
- 2 Click on the “MP-VT1” drive icon on the computer to open it. There are two folders inside: UTILITY and MUSIC.
- 3 Drag and drop MP3 files from the computer into the MUSIC folder. The MP3 files appear in the MUSIC folder when copying to the MP-VT1’s memory is complete.

- 4 When finished copying files, from the computer, follow the procedures for your computer operating system to disconnect the MP-VT1, and then disconnect the USB cable. The MP-VT1 automatically restarts.

### TIP

- You can create subfolders inside the MUSIC folder. Two levels of subfolders can be used. By setting the unit to play tracks only in a selected folder, you can categorize tracks or create folders for different users, for example. (See “Setting the play area” on page 15.)
- Give names to the sub folders and tracks as you wish them to appear on the MP-VT1 screen. (MP3s with ID3 tags will have Title information shown instead of file names.)
- Subfolders and tracks 3 or more levels below will not appear on the MP-VT1 and cannot be used with the unit.

# 4 – Menus & Settings

## Menu items

Press the **MENU** key to open the menu and access most of the MP-VT1 functions and settings.



### NOTE

*The metronome settings screen is accessed by using the METRO key.*

## Menu overview

The MP-VT1 Menu has the following items.

Menu item	Function
<b>INFORMATION</b>	Show summaries of current file information, memory usage and system settings
<b>BROWSE</b>	Show music files/folders inside the <b>MUSIC</b> folder and allows tracks to be selected for direct playback and adding to the playlist
<b>PLAYLIST</b>	Show and edit the playlist (move and erase playlist tracks)
<b>PLAY MODE</b>	Set the playback area and repeat mode
<b>PB CONTROL</b>	Set tempo, key, and voice cancel settings
<b>EFFECT</b>	Set and use the built-in mic effects
<b>TUNER</b>	Set and use the auto tuner and the oscillator
<b>SETUP</b>	Make various global settings and initialize and format the unit

## Using the Menus

Use the **MENU** and **ENTER** keys and the wheel for most menu operations. (See “Top Panel” on page 5.)

The currently selected item appears as light letters on a dark background.

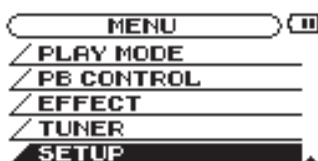

### NOTE

*You can use the menus and metronome while a track is playing.*

# 4 – Menus & Settings

## Operation example

In this example, we change the fast forward and reverse speed by using the **SETUP** menu **CUE/REV SPEED** item.

- 1 With the Home screen open, press the MENU key.  
The MENU screen with the list of menus appears.



### NOTE

As shown above, the ▼ at the bottom right of the screen indicates that there are items not shown that can be accessed by scrolling down. If the ▲ appears in the same area, there are items not shown that can be accessed by scrolling up.

- 2 Turn the wheel to select the **SETUP** screen and press the ENTER key to open the **SETUP** screen.

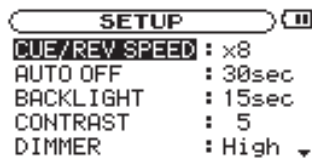

- 3 Turn the wheel to select **CUE/REV SPEED** and press the ENTER key. The current setting is highlighted.
- 4 Turn the wheel to choose the desired value.

### NOTE

▲ and ▼ appear to the right of the setting value and indicate whether the value can be raised or lowered.

For example, in the case of **CUE/REV**, there are five possible settings: X2, X4, X6, X8 and X10.

If the lowest value (in this example, X2) is set, then the ▲ appears, showing that the value can be raised.

If the highest value (in this example, X10) is set, then the ▼ appears, showing that the value can be lowered.

If set at any other value, both ▲ and ▼ appear showing that the value can be raised or lowered.

5. Press the MENU key repeatedly to return to the Home screen. Each time you press this key, you will return to the previous level of operation.

### NOTE

The **METRONOME** screen works in the same way as the other Menus. (See the "Using the metronome" chapter on page 19.)

# 5 – Playing and Selecting Tracks

## Basic track playback functions

Use the ►/||, ◀◀ and ▶▶ keys to operate the MP-VT1 in the same way that you would use an ordinary CD player or other music device.

### Playing a track

Press the ►/|| key to start playback of a track that is stopped.

### Pausing a track

Press the ►/|| key to pause a track that is playing at the position where you press the key.

### Selecting a track

Press the skip (◀◀ and ▶▶) keys to select a track. This is possible during playback or when paused.

Pressing the ◀◀ key during playback or when a track is paused returns the playback position to the beginning of that track.

Pressing the ◀◀ key when stopped at the beginning of a track skips to the beginning of the previous track.

Pressing the ▶▶ key always skips to the beginning of the next track.

### NOTE

*The ■ indicator appears on the display when playback is stopped at the beginning of a track. The || indicator appears when playback is paused at any other point in a track.*

### Searching a track

Press and hold the ◀◀ and ▶▶ keys to search backward and forward through a track (rewind and fast forward).

### Adjusting the volume

Use the OUTPUT VOLUME keys (+, -) to adjust the playback volume. During adjustment, the current volume level appears at the bottom of the display. Since the OUTPUT VOLUME keys adjust the volume level of all MP-VT1 sound output, they also affect the volume level of a connected mic.



### Selecting a track to play

There are two ways to choose the track that you want to play. You can use the ◀◀ and ▶▶ keys when the Home screen is open or you can use the BROWSE screen (see below).

## Using the Browse screen to select tracks

On the BROWSE screen, you can see the contents of the MUSIC folder. You can immediately start playback of a track by selecting a music file on this screen and pressing the ►/|| key.

### NOTE

*You can also add tracks to the playlist on the BROWSE screen. Use a computer to erase or move files and folders in the MUSIC folder. You cannot do this using the BROWSE screen.*

To open the BROWSE screen, press the MENU key to open the MENU screen, then select the BROWSE item and press the ENTER key.



The BROWSE screen shows the folders and music files by their levels. Open a folder to see the music files in it. To open a folder, select it and press the ENTER key.

### MUSIC

The MUSIC folder is the top level folder shown in the BROWSE screen.



This indicator appears next to the names of music files.

Select a music file and press the ►/|| key to start playing that track and return to the Home screen immediately.

Select a music file and press the ENTER key to open a popup window that allows you to add that track to the playlist. (See “Using the playlist” on page 16.)

### NOTE

*Files with extensions other than MP3 do not appear.*

(Continues on next page.)

# 5 – Playing and Selecting Tracks



This indicator appears next to folders that contain subfolders.



This indicator appears next to folders that do not contain subfolders.

The following **BROWSE** screen shows what happens after the folder named “Favorite” has been opened.



The contents of this folder (in this example, Favorite) are shown on the screen.



Select this indicator and press the **ENTER** key to close the open folder and return to the screen showing the contents of the folder that holds it.

## Setting the play area

You can set the MP-VT1 to play only a specific group of tracks from the Home screen by setting the play area. This makes track selection easier when you have numerous tracks on the unit.

Use the **PLAY MODE** menu to set the play area.

- 1 Press the **MENU** key to open the **MENU** screen, and select and open the **PLAY MODE** screen.

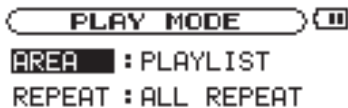

- 2 Select the **AREA** item and press the **ENTER** key.
- 3 Choose one of the following play area options.

### ALL

Allows Home screen playback of all accessible files that have been transferred to the MP-VT1's MUSIC folder from a computer.

### FOLDER

Allows Home screen playback of all accessible files in the same folder as the currently selected track.

To change the current folder, go to the **BROWSE** screen and select any track inside the desired folder. (See “Using the Browse screen to select tracks” on page 14.)

### NOTE

*Only files in the currently selected folder are available for Home screen playback. Files inside subfolders within the selected folder are not available.*

### PLAYLIST

Allows Home screen playback of all files added to the playlist. (See “Using the playlist” on page 16.)

If no files have been added to the playlist, then **No PLAYLIST** appears. Add files to the playlist or make a different selection.

### NOTE

*The current play area setting appears at the bottom left of the Home screen.*



# 5 – Playing and Selecting Tracks

## Using the playlist

You can create a list of tracks (playlist) for playback. Select “**PLAYLIST**” for the **AREA** item on the **PLAY MODE** screen. Tracks that can be selected and played from the Home screen are then limited to those added to the playlist.

### Adding tracks to the playlist

- 1 Press the **MENU** key to open the **MENU** screen. Then, select and open the **BROWSE** screen.
- 2 Select a track (music file) that you want to add to the playlist and press the **ENTER** key.

A popup window for adding tracks to the playlist appears.

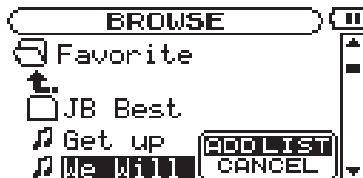

- 3 Select **ADD LIST** and press the **ENTER** key.

The track is added to the playlist and the popup window closes.

#### NOTE

If you select **CANCEL** and press the **ENTER** key, the track is not added and the popup window closes.

- 4 Repeat steps 2 and 3 as necessary to add more tracks to the playlist. The tracks are numbered in the order that they are added.

### Editing the playlist

You can view and edit the playlist on the **PLAYLIST** screen.

- 1 Press the **MENU** key to open the **MENU** screen. Select **PLAYLIST** and press **ENTER** to open the **PLAYLIST** screen.

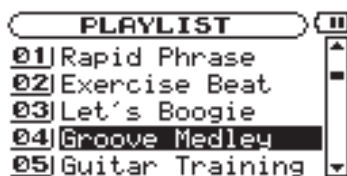

- 2 Select the track that you want to edit and press the **ENTER** key to open a popup window.



The remaining procedures differ according to which of the three items that you choose to edit.

#### NOTE

Select **CANCEL** in the popup window and press the **ENTER** key to quit the procedure without making any change.

#### ALL CLR: Remove all tracks from the playlist

Select this to remove all tracks from the playlist. (In this case, it does not matter which track you select in step 2.) This removes tracks from the playlist, but it does not erase them from the MP-VT1.

- 3 Select **ALL CLR** from the popup window and press the **ENTER** key.

A confirmation message appears.

- 4 Press the **ENTER** key to remove all the tracks from the playlist.

Press the **MENU** key to cancel this action.

#### DELETE: Remove one track from the playlist

Select this to remove a track from the playlist. This removes the track from the playlist, but it does not erase it from the MP-VT1.

- 3 Select **DELETE** from the popup window and press the **ENTER** key.

The track is removed from the playlist.

(Continues on next page.)



# 5 – Playing and Selecting Tracks

## MOVE: Change the order of tracks

Select this to change the order of tracks in the playlist.

- 3 Select **MOVE** from the popup window and press the **ENTER** key.



The track's number is highlighted.

- 4 Use the wheel to move the track to a different position in the playlist.



In the example shown above, the 4th track in the list is being moved to the 3rd track position.

- 5 Press the **ENTER** key to complete track reordering and return to the ordinary **PLAYLIST** screen.

---

## Repeat and single-track playback (PLAY MODE)

---

Repeat playback of the current track or all tracks in the selected play area is possible. Playing a single track just once is also possible.

- 1 Press the **MENU** key to open the **MENU**, and select and open the **PLAY MODE** screen.

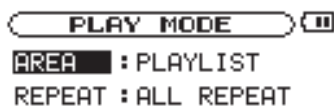

- 2 Select the **REPEAT** item to set one of the following modes.

### OFF

All tracks in the current play area play once in order.

### SINGLE

The current track plays once without repeating and the (Single indicator) appears on the Home screen.

### 1 REPEAT

The current track plays repeatedly and the (1track repeat indicator) appears on the Home screen.

### ALL REPEAT

All tracks in the current play area play repeatedly and the (all track repeat indicator) appears on the Home screen.

### NOTE

*Loop playback automatically turns OFF any active **PLAY MODE** repeat mode.*

# 6 – Practice Functions

## Changing playback pitch and tempo

Not only can you use the MP-VT1 to change the tempo of track playback, you can do this without changing the pitch. You can also change the playback pitch of a track without changing the tempo.

These changes can be made on the **PB CONTROL** screen. When the Home screen is open, press the **ENTER** key to open the **PB CONTROL** screen.

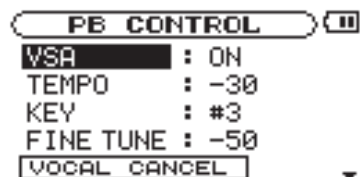

### NOTE

*You can also access this menu from the MENU screen by selecting and opening PB CONTROL.*

## Changing the tempo (TEMPO)

Use the **TEMPO** item to change the track tempo, including reducing it up to 50%.

Playback speed is altered according to the tempo value setting. The number shown is a percentage change.

On the Home screen the **TMP** indicator appears as light letters on a dark background.

The available tempo change values depend on whether the **VSA** function is ON or OFF.

**VSA: ON** Choose one of the following values (%):  
-50, -32, -16, -12, -8, -4, 0, +4, +8, +12, +16

**VSA: OFF** Choose any value between -50 and +16 (%)

### NOTE

*If you set the tempo adjustment value when VSA is OFF and then turn VSA ON, the nearest tempo value is selected automatically*

## Change tempo without changing pitch (VSA)

Turn the Variable Speed Audition (**VSA**) function ON to keep the pitch the same when changing the tempo. Use the **VSA** item to turn the **VSA** function ON and OFF.

When ON, the **VSA** indicator appears on the Home screen as light letters on a dark background.

### NOTE

*During use of pitch control functions, playback may sometimes sound uneven. This is the result of special processing and is not a malfunction.*

## Change key without changing tempo (KEY)

Use the **KEY** item to change the pitch in semitones without changing the tempo.

Use the **KEY** item to adjust the pitch up or down by 1–6 semitones (#6–b6).

When **KEY** is ON (changed from 0), the **KEY** indicator appears as light letters on a dark background on the Home screen.

Use the **FINE TUNE** item to adjust the pitch in cents (100 cents = 1 semitone).

## Canceling mic sounds (VOICE CANCEL)

Use the voice cancel function to control the apparent level of voices in tracks being played back. Use the three **VOICE CANCEL** items on the **PB CONTROL** screen to set up the voice cancel function.

### CANCEL

Set the **CANCEL** item to **ON** to turn the voice cancel function ON. On the Home screen, the **V.C** indicator appears as light letters on a dark background.

### NOTE

*The effectiveness of this function varies between tracks and it cannot completely eliminate all voice sounds. If turning this function ON does not reduce the apparent voice level sounds as you want, or it cancels different instrument parts, try adjusting the following parameters for better results.*

By adjusting the **RANGE** and **PART** items, you may be able to achieve even more thorough voice cancellation. Please listen as you adjust these settings to find the best setting.

### RANGE

Use the **RANGE** item to set the frequency range in the stereo position set with the **PART** item to be cancelled to either mid-range frequencies (MID), which covers most voice sounds, or the full range of frequencies (ALL).

### PART

Use the **PART** item to determine the position in the stereo spectrum (L10—R10) for cancellation.

For example, if the part you want to cancel is panned to the left, try setting **PART** to L10 and adjust it toward the center (L9, L8, etc.) until you achieve best cancellation.

# 6 – Practice Functions

## Repeat playback of a selected loop

Follow these procedures to repeat playback of a selected part of a track (loop playback).

- 1 Press the I/O key when a track is playing or paused at the point where you want to set the IN point (loop starting point).
- 2 Press the I/O key again at the point when you want to set the OUT point and start loop playback between the IN and OUT points.

### NOTE

Loop playback automatically turns OFF any active PLAY MODE repeat mode.

Below the playback position bar on the Home screen, the “I” indicator appears at the IN point, and the “O” indicator appears at the OUT point. During loop playback, **I+O** appears on the LCD.

- To stop loop playback press either the LOOP key or the I/O key.
- If you press the LOOP key, the loop IN and OUT points are kept, so you can play the same loop if you press the LOOP key again.
- If you press the I/O key, the loop IN and OUT points are cleared.

## Connecting a mic to practice

You can connect a mic and mix your voice or the sound of an instrument playing with the track being played back.

You can also use the built-in mic effects to craft the mic sound for even more effective practice and performance.

- 1 Connect a mic to the MIC IN jack.
- 2 Adjust the mic volume with the INPUT dial.

The mic sound is output through the  $\Omega$ /LINE OUT jack. (See “Connecting a Mic” on page 10 for more information.)

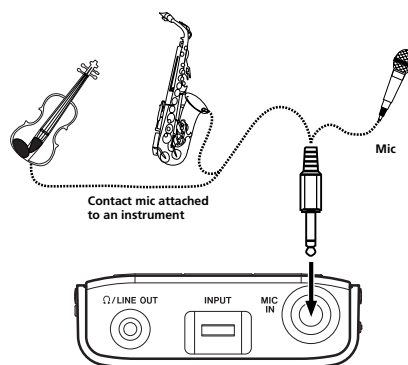

## Practicing with tracks as they play

If you sing or play an instrument while a track is playing back, you can hear the combined signals of the mic and the track output through the  $\Omega$ /LINE OUT jack.

Use the MIX BALANCE keys to adjust the volume level balance between the track being played back (PLAYBACK) and the mic (MIC) signals.

As you adjust the balance, a status bar appears at the bottom of the display.



## Using the metronome (METRONOME)

Use the MP-VT1's built-in metronome during practice to improve your timing.

To use the metronome, press the METRO key to open the METRONOME screen and open the METRONOME item.

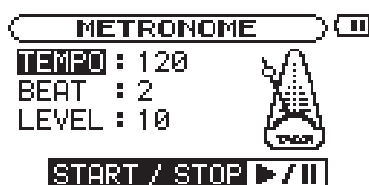

### TEMPO

Use to set the tempo between 20 and 250.

### BEAT

Set the accent between 0 and 9. There is no accent when set to 0.

### LEVEL

Use to set the metronome volume.

### Turning the metronome ON and OFF

Press the **▶/||** key to start and stop the metronome.

Even the metronome is ON, you can select other menus and adjust those settings. Press the METRO key again to return to the MENU screen.

Stop the metronome and press the METRO key if you want to return to the Home screen.

# 7 – Using Effects

The MP-VT1 has built-in mic effects.

Press the **MENU** key and select the **EFFECT**. The display shows as below.

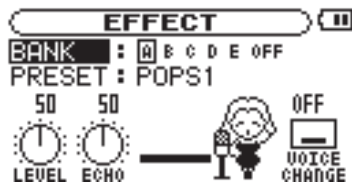

As with other screens, use the wheel to select items and adjust setting values and press the **ENTER** key to confirm selections. Use the **MENU** key to return to previous items or screens.

As shown in the figure above, in addition to **BANK** and **PRESET**, the **EFFECT** screen also shows the **LEVEL** and **ECHO** knobs, and the **VOICE CHANGE** icon. These all have adjustable settings. Turn the wheel when the **EFFECT** screen is open to select the **LEVEL** or **ECHO** knobs, or the **VOICE CHANGE** icon. These items appear darker when selected just like menu items.

## NOTE

*Each preset has a different set of effect modules. See the Effect presets list on page 25 for which modules are included with each preset.*

## BANK

Choose effects from 5 banks (**A** to **E**). When one of the banks is selected, the **FX** indicator is shown in light letters on a dark background at the bottom right of the Home screen.

Each bank can be loaded with a preset. Load a favorite preset to the banks so that you can quickly switch effects between the five banks.

**OFF** can be selected to bypass the effects.

## PRESET

Choose from **18** presets with a different selection of effects. The module icon(s) shown on the screen changes as a preset selected. (See the “Effect presets list” on page 25 for details.)

## LEVEL knob

Use this to adjust the effect output level. Select the knob and press the **ENTER** key. When the number above the knob appears light on a dark background, you can adjust it using the wheel to a value between 0 (no sound from the effect) and 100.

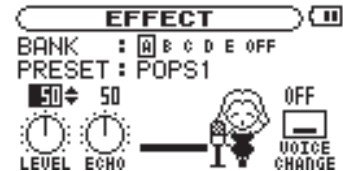

Pressing the **MENU** key exits the parameter setting and returns to the **LEVEL** knob item.

To return to the Home screen, press the **MENU** key when the item (not the parameter) is selected.

## ECHO knob

Adjusts the selected effect. Turn the wheel to select the **ECHO** knob and press the **ENTER** key. When the number above the knob appears light on a dark background, you can adjust the value.

## NOTE

*Although this knob is always labeled “ECHO,” the parameter controlled is different for some effects. Please try them out to hear what they do!*

## Voice Change icon

The sound from the mic inputs can be raised or lowered one octave using the voice change function. This is useful to achieve special sounds. Turn the wheel to select the **Voice Change** icon and press the **ENTER** key. When the setting above the icon appears light on a dark background, you can adjust it as follow:

<b>DOWN</b>	lowers the input pitch one octave
<b>OFF</b>	does not change the input pitch
<b>UP</b>	raises the input pitch one octave

# 8 – Using the Tuner

The MP-VT1 has a built-in tuner. There are Chromatic tuner and Oscillator modes that can output any pitch between C4 and B6. To use the tuner functions, press the **MENU** key to open the **MENU** screen, and select and open the **TUNER** item.

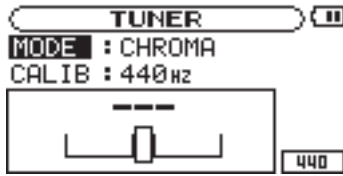

**MODE** Select from the following tuner modes.

**CHROMA** Chromatic tuning mode

**OSC.** Oscillator mode

### CALIB

You can adjust the frequency of A between 435 and 445 Hz. The value of this setting also appears at the bottom right of the screen. This setting affects all tuner modes.

The following sections explain how to use each of the three tuner modes.

### Chromatic tuner mode

This is the default mode.

**1 With the microphone connected to the MIC IN jack, sing or play the instrument that you want to tune.**

**The pitch closest to the frequency of the played note appears at the top of the meter.**

**2 Tune the instrument approximately until the desired pitch name is shown on the screen.**

**3 When the center of the meter lights, the source instrument is in tune.**

A bar appears on the left side of the meter if the pitch is too low, and on the right side if the pitch is too high. The longer the bar is, the more out of tune the **instrument** is.

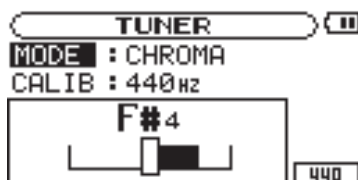

### Oscillator mode (OSC.)

Use the built-in oscillator to output a sine wave through the  $\Omega$ /LINE OUT jack. You can set this wave to any note in a 3-octave range between C4 and B6.

### NOTE

Use this to set the pitch of the note to be output between C4 and B6.

### OUT

Use this to turn the oscillator output ON and OFF. When ON, the onscreen tuning fork provides visual feedback.

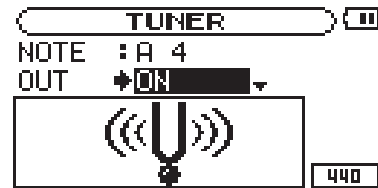

### LEVEL

Use this to set the output level (0–100) of the oscillator.

# 9 – Setup Menu Options

On the **SETUP** screen, you can make various MP-VT1 settings, as well as initialize or format the unit. Press the **MENU** key to open the **MENU** screen, and then select and open the **SETUP** item.

The following settings related to how the MP-VT1 operates and its display behaves can be made on the **SETUP** screen.

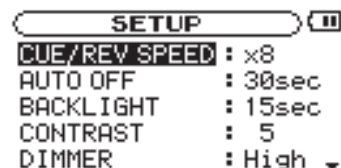

```

  SETUP
CUE/REV SPEED : x8
AUTO OFF      : 30sec
BACKLIGHT     : 15sec
CONTRAST      : 5
DIMMER        : High

```

---

## Cue and review speed

Use **CUE/REV SPEED** to determine how fast search occurs when the **▶▶** and **◀◀** keys are pushed and held.

Setting choices: **x2**, **x4**, **x8** (factory setting), **x10**

---

## Automatic power off

Use **AUTO OFF** to set how long until the unit automatically turns OFF when powered by the internal battery. This setting is the amount of time from when track playback has stopped and the unit has last been used.

Setting choices: **OFF** (factory setting, the power must be turned off manually), **3 min**, **5 min**, **10 min**, **30 min**

---

## Automatically turning off the backlight

Use **BACKLIGHT** to set the time since the last operation until the backlight automatically turns OFF when powered by the internal battery.

Setting choices: **OFF** (backlight always on), **5 sec** (factory setting), **10 sec**, **15 sec**, **30 sec**

---

## Display contrast

Use **CONTRAST** to adjust the display contrast.

Setting choices: **1–20** (factory setting: **12**)

---

## Backlight brightness

Use **DIMMER** to adjust the backlight brightness.

Setting choices: **HIGH** (factory setting), **LOW**, **OFF** (no backlight)

---

## Initializing the unit

Use **INITIALIZE** to restore the MP-VT1 to its factory settings.

- 1 Select **INITIALIZE** and press the **ENTER** key to highlight **Exec**.
- 2 Press the **ENTER** key again to open a confirmation popup window.
- 3 Press the **ENTER** key again to initialize the unit.  
Press the **MENU** key to cancel initialization.

# 9 – Setup Menu Options

---

## Formatting the unit quickly

Use **QUICK FORMAT** to format the MP-VT1's flash memory quickly. Formatting the unit erases all files on the unit, but the **MUSIC** and **UTILITY** folders and the mp-gt1.sys files are automatically regenerated.

- 1 Select **QUICK FORMAT** and press the **ENTER** key to highlight **Exec**.
- 2 Press the **ENTER** key again to open a confirmation popup window.
- 3 Press the **ENTER** key again to format the unit quickly.  
Press the **MENU** key to cancel formatting.

---

## Formatting the unit completely

Use **FULL FORMAT** to format the MP-VT1's flash memory completely. Unlike **QUICK FORMAT**, **FULL FORMAT** also checks the memory for errors. For this reason, it takes much more time. Formatting the unit erases all files on the unit, but the **MUSIC** and **UTILITY** folders and the mp-gt1.sys files are automatically regenerated.

- 1 Select **FULL FORMAT** and press the **ENTER** key to highlight **Exec**.
- 2 Press the **ENTER** key again to open a confirmation popup window.
- 3 Press the **ENTER** key again to format the unit fully.  
Press the **MENU** key to cancel formatting.

### **WARNING**

*Using **QUICK FORMAT** or **FULL FORMAT** erases the **MANUAL** folder and the pdf *Owner's Manual* in it. Please make a copy of this file before formatting the unit.*

### **CAUTION**

*When using **QUICK FORMAT** or **FULL FORMAT**, use the **AC adapter** (sold separately) or confirm that the battery is sufficiently charged. If the power fails during formatting, the formatting may not occur correctly.*

# 10 – Using the Information Pages

Use the **INFORMATION** screen to view various information about files, memory usage and MP-VT1 system settings.

Press the **MENU** key to open the **MENU** screen and select and open **INFORMATION**.

Use the wheel to switch between the three **INFORMATION** pages.

**FILE** Currently active MP3 file data

**MEMORY** Built-in flash memory use

**SYSTEM** MP-VT1 system settings and firmware version

## File information page (FILE)

Shows information about the currently selected file.



**MP3** File bit rate (kbps), CBR or VBR (constant bit rate, variable bit rate), and sampling frequency (kHz)

**TITLE** ID3 tag title information when available; otherwise shows file name

**ALBUM** Shows ID3 tag album information when available; otherwise blank

**ARTIST** Shows ID3 tag artist information when available; otherwise blank

## Memory information page (MEMORY)

Shows status of built-in flash memory usage.

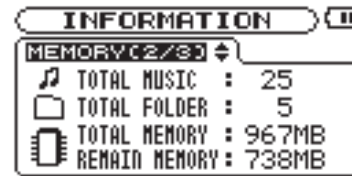

**TOTAL MUSIC** Total number of playable files in the MUSIC folder

**TOTAL FOLDER** Total number of subfolders in the MUSIC folder

**TOTAL MEMORY** Total capacity of the built-in flash memory

**REMAIN MEMORY** Total amount of unused built-in flash memory

### NOTE

*The MP-VT1 can recognize a maximum combined total of 550 files and folders. If there are more than 550, files and folders in excess of this number will not appear on the unit.*

## System information page (SYSTEM)

Shows MP-VT1 system settings information and firmware version.



**CUE/REV SPD** Cue and review speed

**AUTO OFF** Auto power OFF

**BACKLIGHT** Backlight auto OFF

**System Ver.** System firmware version



## Effect preset list

Preset number	Preset name	Effect	Echo parameter range
1	POPS_1	Large “pop” reverb sound 1	0–20
2	POPS_2	Large “pop” reverb sound 2	0–20
3	POPS_3	Large “pop” reverb sound 3	0–20
4	ROCK_1	Lively “rock” reverb 1	0–20
5	ROCK_2	Lively “rock” reverb 2	0–20
6	ROCK_3	Lively “rock” reverb 3	0–20
7	ENKA_1	Vibrato and echo 1 (enka)	0–20
8	ENKA_2	Vibrato and echo 2 (enka)	0–20
9	ENKA_3	Vibrato and echo 3 (enka)	0–20
10	EMPHASIS	Emphasizes “buried” vocals	0–20
11	CHORISTER	Detuned choral effect	0–20
12	QUIVERING VOICE	Strong vocal vibrato	0–30
13	SCREAMING	Flanged vocal sound	0–30
14	PANNING VOICE	Pans the voice between left and right channels	0–30
15	SHOUT	Distorted “shouting” vocal sound	0–20
16	LO-FI VOICE	Low-fidelity vocal sound	0–20
17	MEGAPHONE	Vocal sound through a megaphone	0–100
18	DUET	Mixed duet in harmony	±17

# 12 – Messages

The following is a list of the popup messages that may appear on the MP-VT1. Use this list if one of these popup messages appears and you want to check the meaning or confirm a proper response.

Message	Meaning and response
File not found	Appears when the audio file cannot be found or the file is corrupted. Use a computer to check and reload the audio file.
Non-Supported	This appears when the audio file is not a supported encoding format. Use a computer to check the file format and reencode it and reload it if necessary.
Battery Empty	This warning appears when the battery is almost out of power. Use a USB connection or an AC adapter (sold separately) to recharge it.
I/O Too Short	This appears when using the I/O key to start loop playback if the IN and OUT points are too close together. Reset the IN and OUT points a little further apart and try again.
File Not Found PLAYLIST	The file in the PLAYLIST cannot be found. Please confirm that the file is still in the MUSIC folder.
No PLAYLIST	No files are in the PLAYLIST. This popup appears when the PLAY MODE is set to PLAYLIST, but no files have voice canceln added to the PLAYLIST. Add a file to the PLAYLIST. See “Adding tracks to the playlist” on page 16.
PLAYLIST FULL	This message appears if you try to add another track to the PLAYLIST when it already has 99 tracks. Erase an unneeded file from the PLAYLIST and then add a new file. See “Editing the playlist” on page 16.
Memory Error Init Memory	This message appears if the setup data saved in the Flash Memory is invalid, or is damaged. Press ENTER when the display shows <code>Are you Sure?</code> to initialize the setup data. <b>Caution that the setup data reverts to the factory settings when initialization is executed.</b>
Format Error Format Memory	This message appears if the FAT format in the Flash Memory is invalid, or is damaged. Also, it appears if the Flash Memory was formatted with a computer. Use the MP-VT1 and press ENTER when the display shows <code>Are you Sure?</code> to format the Flash Memory with FAT. <b>Caution that current data in the Flash Memory will be erased when this FAT format operation is executed.</b>
Not Found File Make Sys File	This message appears if the system file cannot be found. Press ENTER when the display shows <code>Are you Sure?</code> to create the system file automatically.
Invalid SysFile Make Sys file	This message appears if the system file is invalid, or is damaged. Press ENTER when the display shows <code>Are you Sure?</code> to overwrite with a correct system file automatically.

# 12 – Messages

Message	Meaning and response
Not Continued	If any of these errors occurs, turn the MP-VT1 power OFF and restart the unit. If the error message continues to appear, contact a TEAC Repair Center.
File Error	
FX Rx Failed	
FX Busy	
Can't Save Data	
Memory Error	
Player Error	
Device Error	
System Err 50	
System Error 1	
System Error 2	
System Error 3	
System Error 4	
System Error 5	
System Error 6	
System Error 7	
System Error 8	
System Error 9	

# 13 – Recycling the Battery

This unit uses a lithium ion battery. Lithium ion batteries are a valuable, recyclable resource. Before disposing of this unit, please remove and recycle its battery.



## WARNING

NEVER TAKE THE UNIT APART FOR ANY PURPOSE OTHER THAN TO REMOVE THE BATTERY BEFORE DISPOSAL!



## How to remove the rechargeable battery

Before removing the battery, turn the unit power switch ON and drain the battery until it ceases to function. (Set the **AUTO OFF** function to **OFF**. See “Automatic power off” on page 22.)

1 Remove the four side screws and remove the upper case.

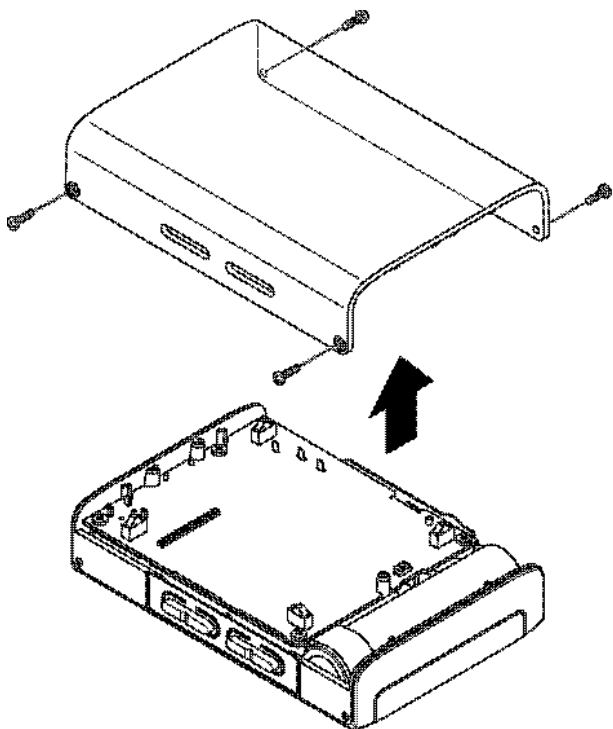

2 Remove the battery from the unit and detach the connector.

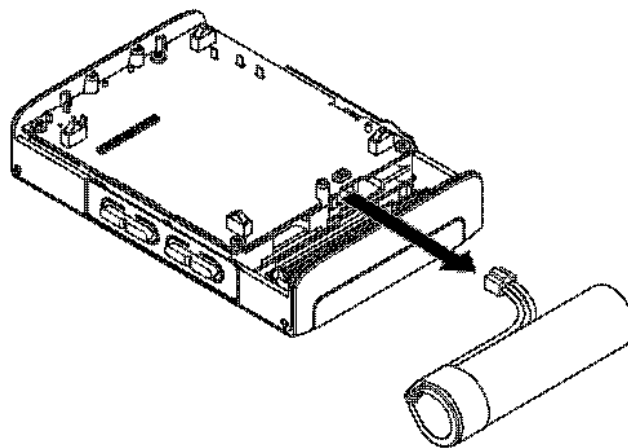

# 14 – Specifications

## Rated audio input and output

Mic Input	Standard phone jack (mono, unbalanced)
<b>Input impedance</b>	> 20 k $\Omega$
<b>Maximum input level</b>	-20 dBV
<b>Standard input level</b>	-40 dB
Phones/Line Out	1/8" (3.5 mm) stereo jack
<b>Maximum output</b>	20 mW + 20 mW (with 32 $\Omega$ headphones connected)

## Audio performance

Frequency characteristics	20 – 20,000 Hz +1/-3 dB (Mic Input > Phones/Line Out)
Total Harmonic Distortion	<0.05% (Mic Input > Line Out)
S/N ratio (Line Out)	>80 dB (0 dBV)

## Other specifications

MP3 file support	Bit rate	32–320 kbps
	Sampling frequency	44.1 kHz
	VBR files	Supported
	ID3 tag display	Up to Ver 2.4
<b>Note that loop playback IN and OUT points may not always set correctly for VBR MP3 files.</b>		
Memory medium	Built-in flash memory (1 GB)	
File system	FAT16 (recognizes a maximum combined total of 550 files and folders)	
Built-in lithium ion battery	3.7V DC	
Power consumption	About 1.5 W (during MP3 playback)	
Dimensions (W x H x D)	78 x 110 x 25.5 mm (3.1 x 4.3 x 1 inches) excluding protrusions	
Weight (including lithium ion battery)	220 g (7.8 ounces)	
Accessory (sold separately)	AC adapter (PS-P520)	

## Minimum computer requirements

Windows PC	Windows 2000, XP, and Vista
	300 MHz Pentium
	128 MB memory
	USB port with 500 mA bus power (USB 2.0 recommended)
Macintosh	Mac OS 10.2 or later
	266 MHz Power PC (including iMacs, G3 and G4 processors)
	64 MB memory
	USB port with 500 mA bus power (USB 2.0 recommended)
Recommended	USB host controller, Intel chipset

# 14 – Specifications

## Stored settings

The following settings are saved when the MP-VT1 power is turned OFF. They are the same when the power is turned ON again.

- EFFECT settings
- TUNER settings
- METRONOME settings
- PB CONTROL settings
- Loop playback ON/OFF status
- Loop IN and OUT point settings
- Playback mode
- Mix balance
- Auto power OFF setting
- Currently active track
- Output volume settings
- Backlight OFF Setting

## Dimensions

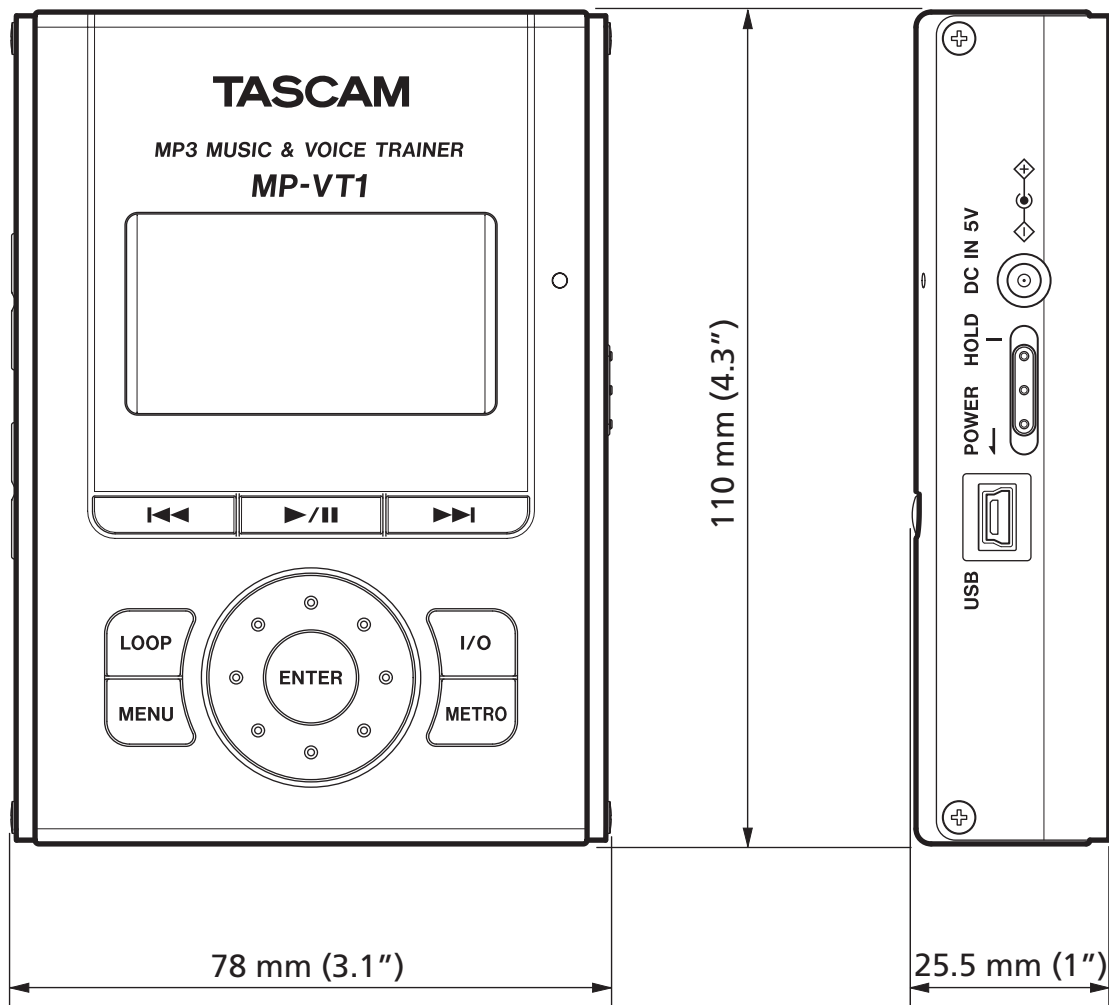

# **TASCAM**

**TEAC Professional Division**

# **MP-VT1**

## **TEAC CORPORATION**

Phone: +81-422-52-5082  
3-7-3, Nakacho, Musashino-shi, Tokyo 180-8550, Japan

[www.tascam.com](http://www.tascam.com)

---

## **TEAC AMERICA, INC.**

Phone: +1-323-726-0303  
7733 Telegraph Road, Montebello, California 90640

[www.tascam.com](http://www.tascam.com)

---

## **TEAC CANADA LTD.**

Phone: +1905-890-8008  
5939 Wallace Street, Mississauga, Ontario L4Z 1Z8, Canada

[www.tascam.com](http://www.tascam.com)

---

## **TEAC MEXICO, S.A. De C.V**

Phone: +52-555-581-5500  
Campesinos No. 184, Colonia Granjes Esmeralda, Delegacion Iztapalapa CP 09810, Mexico DF

[www.tascam.com](http://www.tascam.com)

---

## **TEAC UK LIMITED**

Phone: +44-8451-302511  
Unit 19 & 20, The Courtyards Hatters Lane, Watford, Hertfordshire. WD18 8TE, U.K.

[www.tascam.co.uk](http://www.tascam.co.uk)

---

## **TEAC EUROPE GmbH**

Phone: +49-611-71580  
Bahnstrasse 12, 65205 Wiesbaden-Erbenheim, Germany

[www.tascam.de](http://www.tascam.de)

---