



S700HRC

Model No. HRTL14910

Serial No. _____

Write the serial number in the space above for future reference.

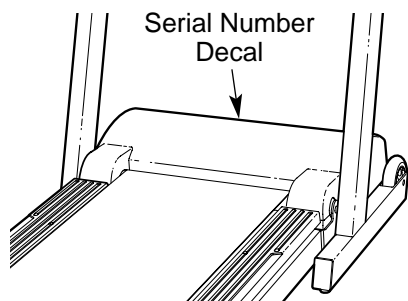

USER'S MANUAL

QUESTIONS?

If you have questions, or if there are missing parts, we will guarantee complete satisfaction through direct assistance from our factory.

TO AVOID UNNECESSARY DELAYS, PLEASE CALL DIRECT TO OUR TOLL-FREE CUSTOMER HOT LINE. The trained technicians on our customer hot line will provide immediate assistance, free of charge.

CUSTOMER HOT LINE:

1-800-999-3756

Mon.–Fri., 6 a.m.–6 p.m. MST

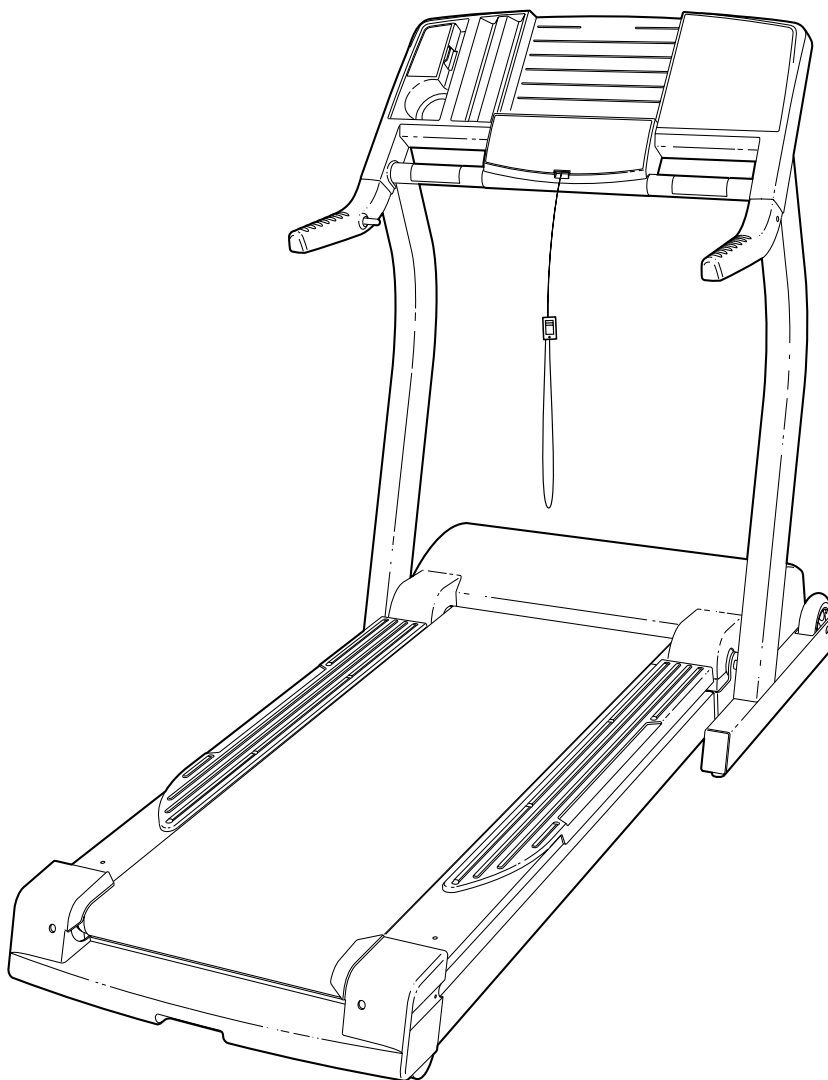

CAUTION

Read all precautions and instructions in this manual before using this equipment. Save this manual for future reference.



Visit our website at

www.healthrider.com

new products, prizes,
fitness tips, and much more!



S700HRC

TABLE OF CONTENTS

IMPORTANT PRECAUTIONS	3
BEFORE YOU BEGIN	5
ASSEMBLY	6
TREADMILL OPERATION	7
HOW TO FOLD AND MOVE THE TREADMILL	23
TROUBLE-SHOOTING AND MAINTENANCE	25
EXERCISE GUIDELINES	28
PART LIST	30
HOW TO ORDER REPLACEMENT PARTS	31
LIMITED WARRANTY	Back Cover

Note: An EXPLODED DRAWING is attached in the center of this manual.

IMPORTANT PRECAUTIONS

⚠️ WARNING: To reduce the risk of burns, fire, electric shock, or injury to persons, read the following important precautions and information before operating the treadmill.

1. It is the responsibility of the owner to ensure that all users of this treadmill are adequately informed of all warnings and precautions.
2. Use the treadmill only as described in this manual.
3. Place the treadmill on a level surface, with eight feet of clearance behind it. Do not place the treadmill on any surface that blocks air openings. To protect the floor or carpet from damage, place a mat under the treadmill.
4. Keep the treadmill indoors, away from moisture and dust. Do not put the treadmill in a garage or covered patio, or near water.
5. Do not operate the treadmill where aerosol products are used or where oxygen is being administered.
6. Keep children under the age of 12 and pets away from the treadmill at all times.
7. The treadmill should not be used by persons weighing more than 275 pounds. Never allow more than one person on the treadmill at a time.
8. Wear appropriate exercise clothing when using the treadmill. Do not wear loose clothing that could become caught in the treadmill. Athletic support clothes are recommended for both men and women. Always wear athletic shoes. Never use the treadmill with bare feet, wearing only stockings, or in sandals.
9. When connecting the power cord (see page 7), plug the power cord into a surge suppressor (not included) and plug the surge suppressor into a grounded circuit capable of carrying 15 or more amps. No other appliance should be on the same circuit.
10. Use only a single-outlet surge suppressor that is UL 1449 listed as a transient voltage surge suppressor (TVSS). The surge suppressor must have a UL suppressed voltage rating of 400 volts or less and a minimum surge dissipation of 450 joules. The surge suppressor must be electrically rated for 120 volts AC and 15 amps. To purchase a surge suppressor, call toll-free 1-800-806-3651 and order part number 146148.
11. Keep the power cord and the surge suppressor away from heated surfaces.
12. Never move the walking belt while the power is turned off. Do not operate the treadmill if the power cord or plug is damaged, or if the treadmill is not working properly. (See **BEFORE YOU BEGIN** on page 5 if the treadmill is not working properly.)
13. Never start the treadmill while you are standing on the walking belt. Always hold the handrails while using the treadmill.
14. The treadmill is capable of high speeds. Adjust the speed in small increments to avoid sudden jumps in speed.
15. Do not use the hand weights at speeds faster than walking speeds. Using hand weights and not holding the handrails may compromise your ability to maintain your balance. Exercises using hand weights should be attempted only by experienced users.
16. The pulse sensor is not a medical device. Various factors, including the user's movement, may affect the accuracy of heart rate readings. The pulse sensor is intended only as an exercise aid in determining heart rate trends in general.
17. Never leave the treadmill unattended while it is running. Always remove the key, unplug the power cord, and move the on/off switch to the off position when the treadmill is not in use. (See the drawing on page 5 for the location of the on/off switch.)
18. Do not attempt to raise, lower, or move the treadmill until it is properly assembled. (See **ASSEMBLY** on page 6, and **HOW TO FOLD AND MOVE THE TREADMILL** on page 23.) You must be able to safely lift 45 pounds (20 kg) to raise, lower, or move the treadmill.
19. When folding or moving the treadmill, make sure that the storage latch is fully closed.

20. When using iFIT.com CDs and videos, an electronic “chirping” sound will alert you when the speed and/or incline of the treadmill is about to change. Always listen for the “chirp” and be prepared for speed and/or incline changes. In some instances, the speed and/or incline may change before the personal trainer describes the change.

21. When using iFIT.com CDs and videos, you can manually override the speed and incline settings at any time by pressing the speed and incline buttons. However, when the next “chirp” is heard, the speed and/or incline will change to the next settings of the CD or video program.

22. Always remove iFIT.com CDs and videos from your CD player or VCR when you are not using them.

23. Inspect and properly tighten all parts of the treadmill every three months.

24. Never drop or insert any object into any opening.

25. **DANGER:** Always unplug the power cord immediately after use, before cleaning the treadmill, and before performing the maintenance and adjustment procedures described in this manual. Never remove the motor hood unless instructed to do so by an authorized service representative. Servicing other than the procedures in this manual should be performed by an authorized service representative only.

26. The treadmill is intended for in-home use only. Do not use the treadmill in any commercial, rental, or institutional setting.

⚠ WARNING: Before beginning this or any exercise program, consult your physician. This is especially important for persons over the age of 35 or persons with pre-existing health problems. Read all instructions before using. ICON assumes no responsibility for personal injury or property damage sustained by or through the use of this product.

SAVE THESE INSTRUCTIONS

The decals shown below have been placed on your treadmill. If a decal is missing, or if it is not legible, please call our Customer Service Department toll-free at 1-800-999-3756 to order a free replacement decal. Apply the decal in the location shown. Note: The long decal is shown at 38% of actual size.

⚠ WARNING: Protect yourself and others from risk of serious injury. Read the user’s manual and:

- Fully engage storage latch before treadmill is moved or stored.
- Reduce incline to lowest level before folding treadmill into storage position.
- Stand only on side rails when starting or stopping treadmill.
- Change speed in small increments.
- Hold handrails to prevent falling, and always wear the safety clip while operating treadmill.
- Stop if you feel faint, dizzy, or short of breath.
- Never allow children on or around treadmill.
- Remove key when not in use.
- Keep clothing, fingers, and hair away from moving belt.
- Never try to adjust or fix the belt while it is moving.
- Always wear athletic shoes while operating treadmill.



⚠ CAUTION
 KEEP HANDS AND FEET AWAY FROM THIS AREA WHILE THE TREADMILL IS IN OPERATION.

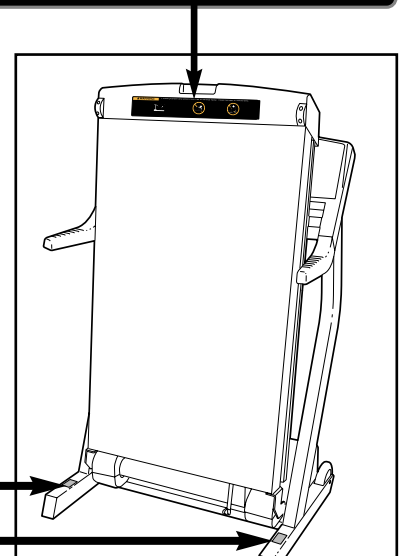

BEFORE YOU BEGIN

Congratulations for purchasing the HealthRider® S700HRC treadmill. The S700HRC offers an impressive array of features to help you achieve your fitness goals in the convenience of your home. From the advanced console to the cushioned walking platform, the S700HRC is designed to make each workout more effective and enjoyable. And when you're not exercising, the S700HRC can be folded away, taking less than half the floor space of conventional treadmills.

For your benefit, read this manual carefully before using the treadmill. If you have additional questions,

please call our Customer Service Department toll-free at 1-800-999-3756, Monday through Friday, 6 a.m. until 6 p.m. Mountain Time (excluding holidays). To help us assist you, please note the product model number and serial number before calling. The model number is HRTL14910. The serial number can be found on a decal attached to the treadmill (see the front cover of this manual for the location).

Before reading further, please familiarize yourself with the parts that are labeled in the drawing below.

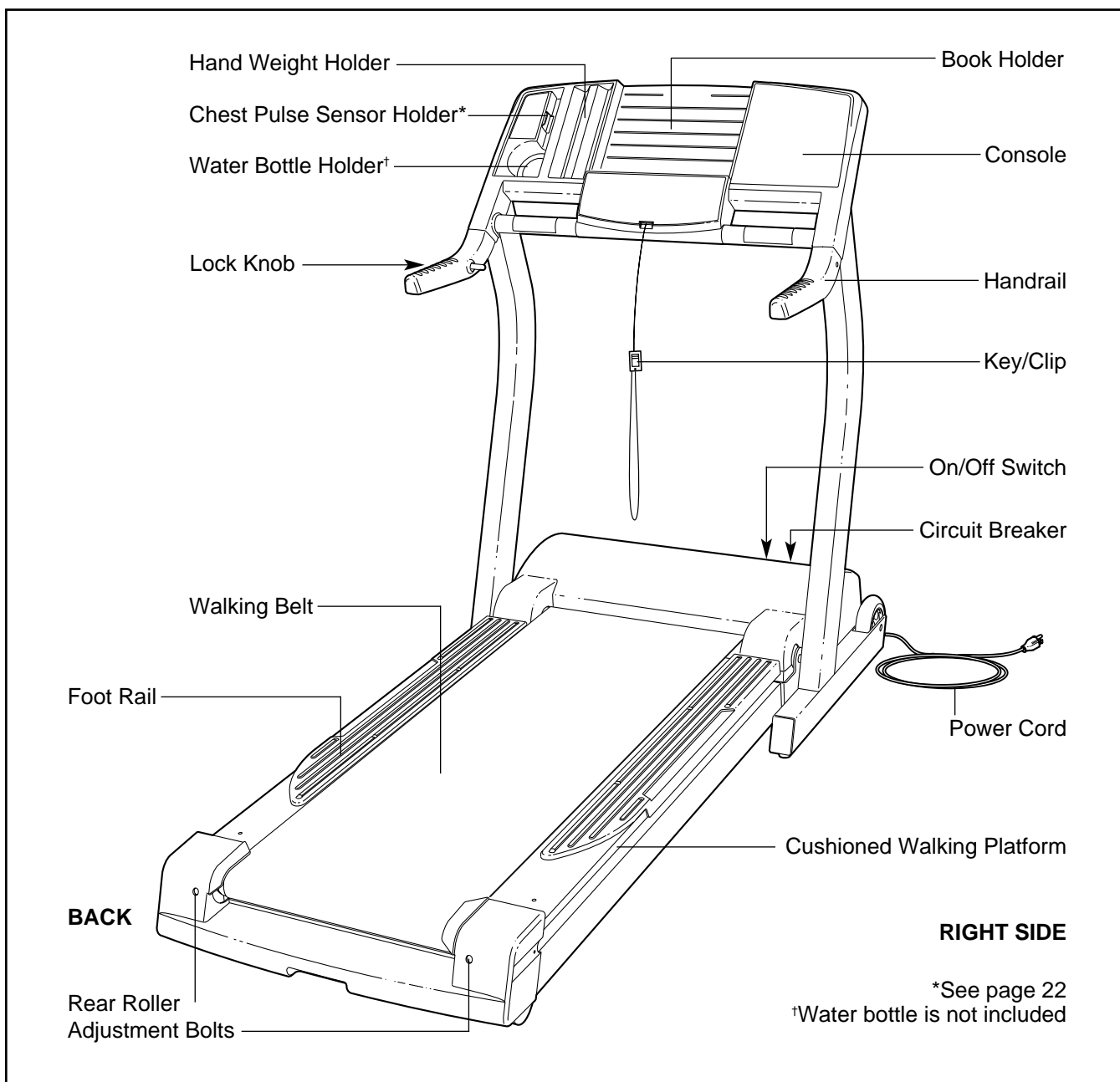

ASSEMBLY

Assembly requires two people. Place the treadmill in a cleared area and remove all packing materials. Do not dispose of the packing materials until the treadmill is assembled. **No tools are required.**

Note: The underside of the treadmill walking belt is coated with high-performance lubricant. During shipping, a small amount of lubricant may be transferred to the top of the walking belt, the sides of the walking platform, or the shipping carton. This does not affect treadmill performance. If there is lubricant on top of the walking belt or on the sides of the walking platform, wipe off the lubricant with a soft cloth and a mild, non-abrasive cleaner.

1. **With the help of a second person,** carefully raise the Uprights (65) until the Wheels (77) are resting on the floor as shown.

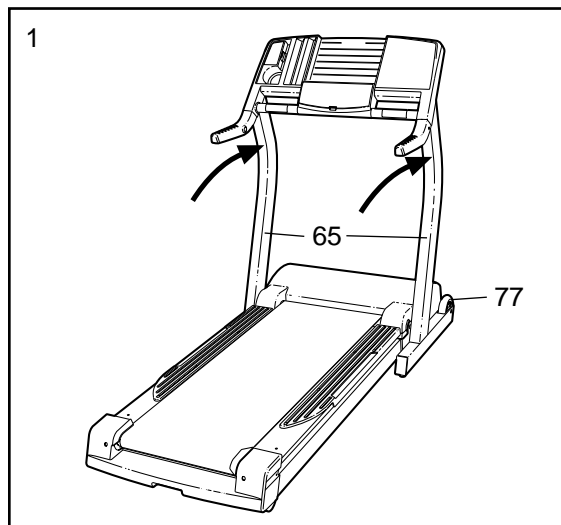

2. Remove the Lock Knob (67) from the Lock Pin (72). Make sure that the Lock Pin Collar (70) and the Spring (69) are on the Lock Pin. (Note: If there are two Lock Pin Collars, there should be one on each side of the Spring.) Insert the Lock Pin through the Left Foam Grip (62), and tighten the Lock Knob onto it.

After assembly has been completed, pull on the Left Foam Grip (62) in the direction shown until the Latch Pin (72) slides freely.

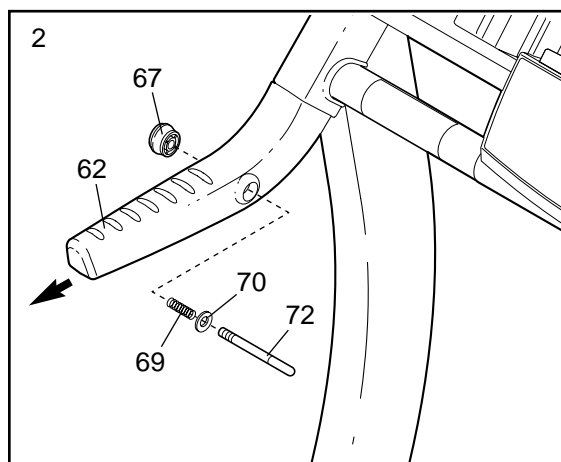

3. **Make sure that all parts are tightened before you use the treadmill. Place a mat beneath the treadmill to protect the floor or carpet.** For your benefit, we recommend that you familiarize yourself with the TROUBLE-SHOOTING AND MAINTENANCE section on pages 25 and 26.

TREADMILL OPERATION

THE PERFORMANT LUBE™ WALKING BELT

Your treadmill features a walking belt coated with PERFORMANT LUBE™, a high-performance lubricant.

IMPORTANT: Never apply silicone spray or other substances to the walking belt or the walking platform. Such substances will deteriorate the walking belt and cause excessive wear.

HOW TO PLUG IN THE POWER CORD

⚠ DANGER: Improper connection of the equipment-grounding conductor can result in an increased risk of electric shock. Check with a qualified electrician or serviceman if you are in doubt as to whether the product is properly grounded. Do not modify the plug provided with the product—if it will not fit the outlet, have a proper outlet installed by a qualified electrician.

Your treadmill, like any other type of sophisticated electronic equipment, can be seriously damaged by sudden voltage changes in your home's power. Voltage surges, spikes, and noise interference can result from weather conditions or from other appliances being turned on or off. **To decrease the possibility of your treadmill being damaged, always use a surge suppressor with your treadmill (see drawing 1 at the right).**

To purchase a surge suppressor, call toll-free 1-800-806-3651 and order part number 146148. Use only a single-outlet surge suppressor that is UL 1449 listed as a transient voltage surge suppressor (TVSS). The surge suppressor must have a UL suppressed voltage rating of 400 volts or less and a minimum surge dissipation of 450 joules. The surge suppressor must be electrically rated for 120 volts AC and 15 amps.

This product must be grounded. If it should malfunction or break down, grounding provides a path of least resistance for electric current to reduce the risk of electric shock. This product is equipped with a cord having an equipment-grounding conductor and a grounding plug. **Plug the power cord into a surge suppressor, and plug the surge suppressor into an appropriate outlet that is properly installed and grounded in**

accordance with all local codes and ordinances. Important: The treadmill is not compatible with GFCI-equipped outlets.

This product is for use on a nominal 120-volt circuit, and has a grounding plug that looks like the plug illustrated in drawing 1 below. A temporary adapter that looks like the adapter illustrated in drawing 2 may be used to connect the surge suppressor to a 2-pole receptacle as shown in drawing 2 if a properly grounded outlet is not available.

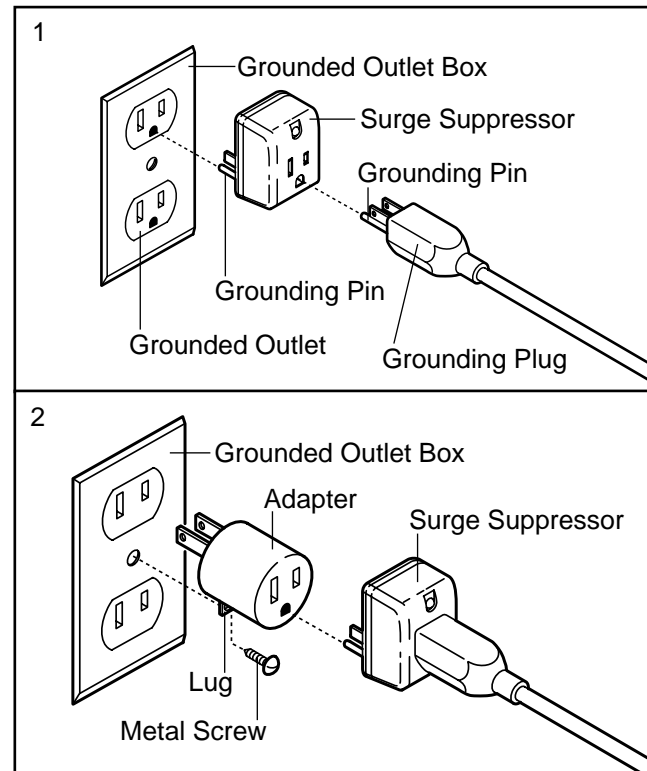

The temporary adapter should be used only until a properly grounded outlet (drawing 1) can be installed by a qualified electrician.

The green-colored rigid ear, lug, or the like extending from the adapter must be connected to a permanent ground such as a properly grounded outlet box cover. Whenever the adapter is used it must be held in place by a metal screw. **Some 2-pole receptacle outlet box covers are not grounded. Contact a qualified electrician to determine if the outlet box cover is grounded before using an adapter.**

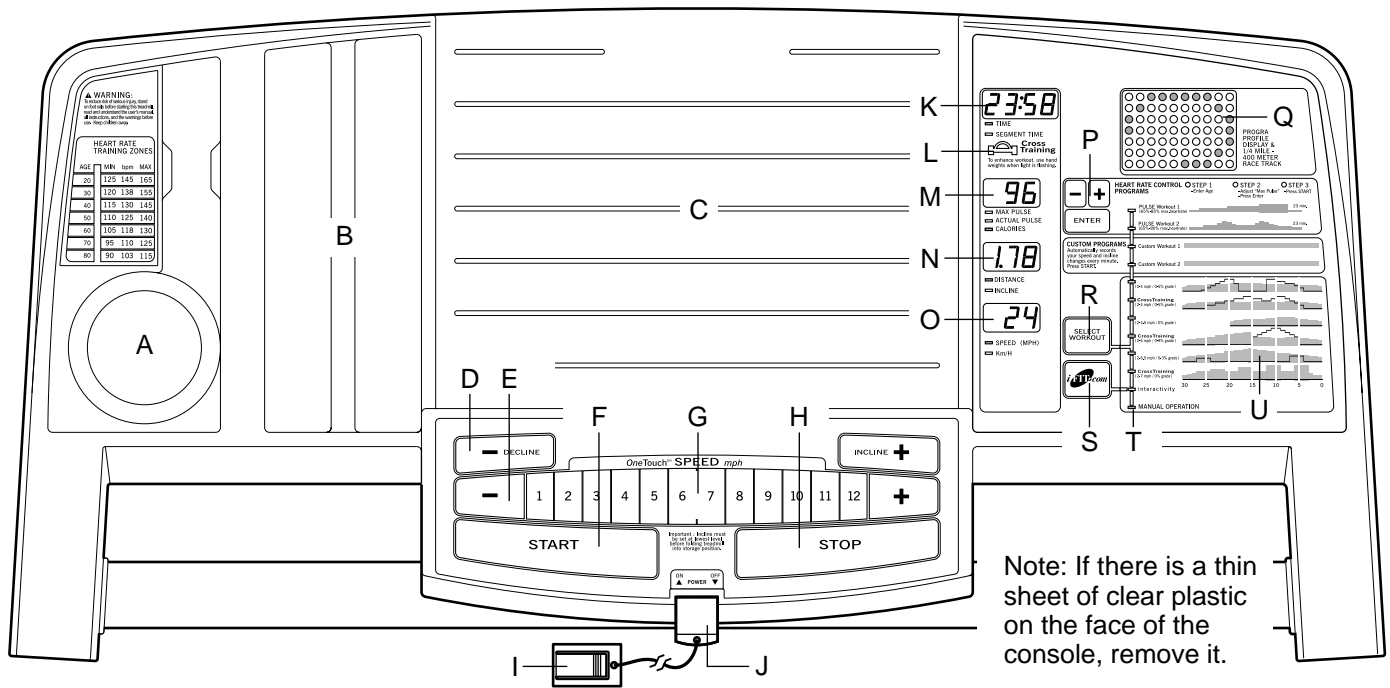

Note: If there is a thin sheet of clear plastic on the face of the console, remove it.

FEATURES OF THE CONSOLE

The treadmill console offers an impressive selection of features to help you get the most from your exercise.

When the console is in the manual mode, the speed and incline of the treadmill can be changed with a touch of a button. As you exercise, the four displays will show your workout time, the number of calories you have burned, the distance you have walked, the incline level of the treadmill, and the speed of the walking belt. The console will also show your heart rate when you use the handgrip pulse sensor or the optional chest pulse sensor (see page 22).

The console also offers six preset workout programs. Each program automatically controls the speed and incline of the treadmill as it guides you through an effective workout. The included hand weights can be used for upper body exercise as well. Two pulse programs are also offered. Each program automatically adjusts the speed and incline of the treadmill to keep your heart rate within a preset range during your workout.

The console even allows you to create your own workout programs and store them in memory for future use.

The console also features new iFIT.com interactive technology. iFIT.com technology is like having a personal trainer right in your home. Using the included audio cable, you can connect the treadmill to your home stereo, portable stereo, or computer and play special iFIT.com CD programs (iFIT.com CDs are available separately). iFIT.com CD programs automatically

control the speed and incline of the treadmill as a personal trainer guides you through every step of your workout. High-energy music provides added motivation. Each CD features two programs designed by certified personal trainers.

In addition, you can connect the treadmill to your VCR and TV and play iFIT.com video programs (videocassettes are available separately). Video programs offer the same benefits as iFIT.com CD programs, but add the excitement of working out with a class and an instructor—the hottest new trend at health clubs.

With the treadmill connected to your computer, you can also go to our Web site at www.iFIT.com and access basic programs, audio programs, and video programs directly from the internet. Additional options, such as on-line competitions, personal training sessions via the internet, and online tracking of your workout history are soon to be available. See www.iFIT.com for details.

To purchase iFIT.com CDs or videocassettes, call toll-free 1-800-735-0768. For information about an optional chest pulse sensor, see page 22.

To use the manual mode of the console, follow the steps beginning on page 10. **To use preset programs**, see page 12. **To use pulse programs**, see page 13. **To create and use custom programs**, see pages 15 and 16. **To use iFIT.com CD or video programs**, see page 19. **To use iFIT.com programs directly from our Web site**, see page 21.

DESCRIPTION OF THE CONSOLE

Refer to the drawing on page 8 to identify the features described below.

- A. Water bottle holder—This convenient holder keeps your water bottle handy during your workouts.
- B. Hand weight holder—These compartments hold the included hand weights.
- C. Book holder—This area is designed to hold a book or magazine.
- D. Incline buttons—These buttons control the incline of the treadmill. Each time a button is pressed, the incline will change by 0.5%. The incline range is 0% to 10%.
- E. Speed buttons—These buttons control the speed of the walking belt. Each time a button is pressed, the speed will change by 0.1 mph; if a button is held down, the speed will change in increments of 0.5 mph. The speed range is 0.5 mph to 12 mph.
- F. Start button—This button is used to start the walking belt.
- G. OneTouch Speed buttons—These buttons allow you to quickly select speed settings.
- H. Stop button—This button is used to stop the walking belt.
- I. Waistband clip—This clip is designed to be worn on the waistband of your clothes. If the key is pulled from the console, the walking belt will automatically stop.
- J. Key—This key turns the console on and off.
- K. Time/Segment Time display—When the manual mode or the iFIT.com mode is selected, this display will show the elapsed time. When a preset program, a pulse program, or a custom program is selected, the display will show both the time remaining in the program and the time remaining in the current segment of the program. The display will alternate between one number and the other every seven seconds.
- L. Cross Training indicator—During the three cross training programs, this indicator will periodically flash. The included hand weights can be used while the indicator is flashing to add upper body exercise to your workouts.
- M. Pulse/Calories display—This display shows the approximate number of calories you have burned. When the handgrip pulse sensor is used, the display will show your heart rate. If the optional chest pulse sensor is worn, the display will show your heart rate and the number of calories you have burned, alternating between one number and the other every seven seconds.
- N. Distance/Incline display—This display shows the distance you have walked and the incline level of the treadmill. The display will alternate between one number and the other every seven seconds. Note: Each time the Incline buttons are pressed, the display will change to show the incline setting.
- O. Speed display—This display shows the speed of the walking belt.
- P. Enter button and + and – buttons—These buttons are used to enter your age when pulse programs are used.
- Q. Program display—When the manual mode or the iFIT.com mode is selected, this display will show your progress on an LED track. When a preset program, a pulse program, or a custom program is selected, the display will show the settings for the program.
- R. Select Workout button—This button is used to select the manual mode, the preset programs, the pulse programs, and the custom programs. Note: If the walking belt is moving when the Select Workout button is pressed, the walking belt will slow to a stop, the displays will be reset, and a new program or the manual mode will be selected.
- S. iFIT.com button—This button is used to select the iFIT.com mode.
- T. Mode indicators—These indicators show whether the manual mode, a preset program, a pulse program, a custom program, or the iFIT.com mode is selected.
- U. Program profiles—These profiles show how the speed and incline of the treadmill will change during preset programs and how the target heart rate will change during pulse programs.

Note: The console can display exercise feedback in either miles or kilometers (see SPEED DISPLAY on page 11). For simplicity, all instructions in this section refer to miles.

⚠ WARNING: To reduce the risk of serious injury, read the following precautions before operating the console.

- Do not stand on the walking belt when turning on the power or starting the walking belt.
- Always wear the clip (see “I” on page 8) on the waistband of your clothes while you are using the treadmill. If the key is pulled from the console, the walking belt will stop.
- The treadmill is capable of high speeds. Adjust the speed in small increments.
- To reduce the risk of electric shock, keep liquids away from the console and place only a sealed water bottle in the console.

HOW TO TURN ON THE POWER

1 Plug in the power cord (see HOW TO PLUG IN THE POWER CORD on page 7).

2 Locate the on/off switch on the front of the treadmill near the power cord. Move the on/off switch to the on position.

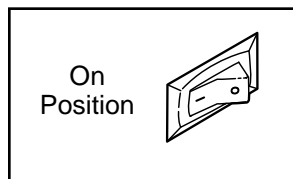

3 Stand on the foot rails of the treadmill. Find the clip attached to the key and slide the clip fully onto the waistband of your clothes. Next, insert the key into the console. After a moment, the displays, the LED track, and various indicators will light. **Test the clip by carefully taking a few steps backward until the key is pulled from the console. If the key is not pulled from the console, adjust the position of the clip as needed.** Then, reinsert the key into the console.

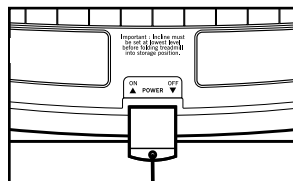

HOW TO USE THE MANUAL MODE

1 Insert the key into the console.

See HOW TO TURN ON THE POWER at the left.

2 Select the manual mode.

When the key is inserted, the manual mode will be selected and the manual indicator will light. If a program is selected, press the Select Workout button repeatedly to select the manual mode.

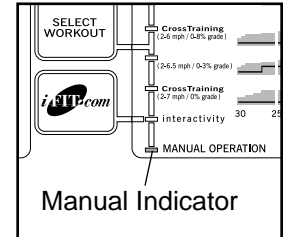

3 Press the Start button or the Speed + button to start the walking belt.

A moment after the button is pressed, the walking belt will begin to move at 1.0 mph. Hold the handrails and begin walking.

As you exercise, adjust the speed of the walking belt as desired by pressing the Speed buttons or the OneTouch Speed buttons. Note: After the buttons are pressed, it may take a moment for the walking belt to reach the selected speed setting.

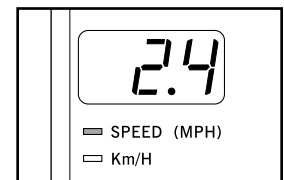

During the first few minutes that you use the treadmill, inspect the alignment of the walking belt, and align the walking belt if necessary (see page 28).

To stop the walking belt, press the Stop button. The displays will pause and the Time/Segment Time display will begin to flash. To restart the walking belt, press the Start button or the Speed + button. To stop the walking belt and reset the displays, press the Stop button, remove the key, and then reinsert the key.

4 Adjust the incline of the treadmill as desired.

To vary the intensity of your exercise, adjust the incline of the treadmill by pressing the Incline buttons. Note: After the buttons are pressed, it may take a moment for the treadmill to reach the selected incline setting.

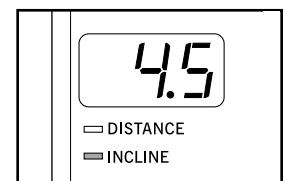

5 Follow your progress with the LED track and the four displays.

LED Track—When the manual mode or the iFIT.com mode is selected, the program display will show a track representing a distance of 1/4 mile. As you exercise, the indicators around the track will light one at a time until the entire track is lit. A new lap will then begin.

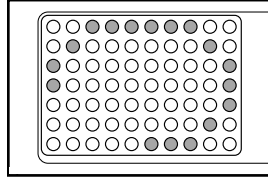

Time/Segment Time display—When the manual mode or the iFIT.com mode is selected, this display will show the elapsed time. When a preset program, a pulse program, or a custom program is selected, the display will show both the time remaining in the program and the time remaining in the current segment of the program. The display will alternate between one number and the other every seven seconds.

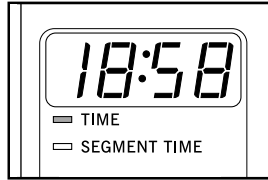

Pulse/Calories display—This display shows the approximate number of calories you have burned. If the optional chest pulse sensor is worn, the display will also show your heart rate. The display will alternate between one number and the other every seven seconds. If the handgrip pulse sensor is used, the display will show your heart rate continuously while your hands are on the pulse sensor.

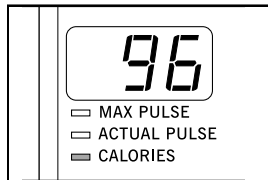

To use the handgrip pulse sensor, **stand on the foot rails** and place your hands on the metal contacts on the handrail as shown—**avoid moving your hands**. After a few seconds, one or two dashes will appear in the Pulse/Calories display and then your heart rate will be shown. **For the most accurate heart rate reading, hold the contacts for about 15 seconds.**

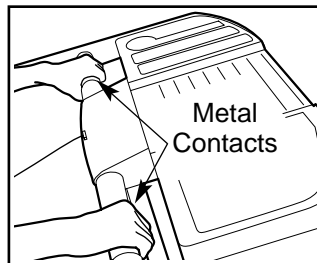

Distance/Incline display—This display shows the distance you have walked and the incline level of the treadmill. The display will alternate between one number and the other every seven seconds. Note: Each time the Incline buttons are pressed, the display will change to show the incline setting.

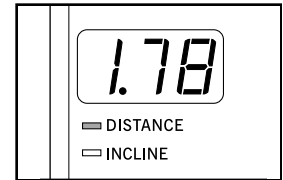

Speed display—This display shows the speed of the walking belt.

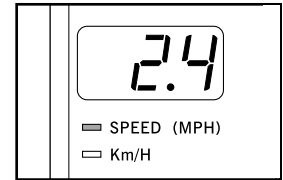

Note: The speed can be displayed in either miles per hour or kilometers per hour. The MPH or Km/H indicator below the Speed display will light to show which unit of measurement is selected. To change the unit of measurement, first hold down the Stop button while inserting the key into the console. The Speed display will show an E for English miles or an M for metric kilometers. Pressing the Speed + button will change the unit of measurement. When the desired unit of measurement is selected, remove and then reinsert the key.

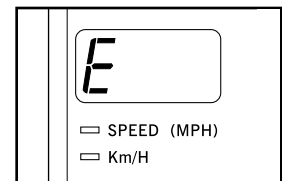

6 When you are finished exercising, stop the walking belt and remove the key.

Step onto the foot rails, press the Stop button, and adjust the incline of the treadmill to the lowest level. **The incline must be at the lowest level when the treadmill is raised to the storage position or the treadmill will be damaged.** Next, remove the key from the console and put it in a secure place. **Note: If the displays and indicators on the console remain lit after the key is removed, the console is in the “demo” mode. Refer to page 22 and turn off the demo mode.**

When you are finished using the treadmill, move the on/off switch near the power cord to the off position and unplug the power cord.

HOW TO USE THE PRESET PROGRAMS

1 Insert the key into the console.

See HOW TO TURN ON THE POWER on page 10.

2 Select one of the six preset programs.

When the key is inserted, the manual mode will be selected. To select one of the preset programs, press the Select Workout button repeatedly until one of the six preset program indicators lights.

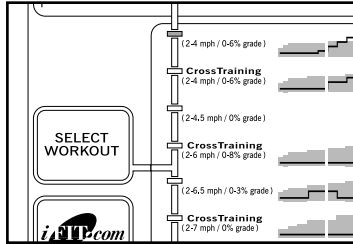

When a preset program is selected, the Distance/Incline display will flash the maximum incline setting for the program for six seconds, and the Speed display will flash the maximum speed setting.

The profiles printed on the right side of the console show how the speed and incline of the treadmill will change during the preset programs. The numbers at the left ends of the profiles show the speed and incline ranges for the programs. The program display will show a simplified profile of the program. The Time/Segment Time display will show how long the selected program will last.

3 Press the Start button or the Speed + button to start the program.

A moment after the button is pressed, the treadmill will automatically adjust to the first speed and incline settings for the program. Hold the handrails and begin walking.

Each program is divided into several time segments of different lengths. The Time/Segment Time display shows both the time remaining in the program and the time remaining in the current segment. One speed setting and one incline setting are programmed for each segment. The speed setting for the first segment will be shown in the flashing Current Segment column of the program display. (The incline settings are not shown

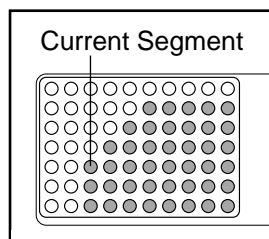

in the program display.) The speed settings for the next seven segments will be shown in the seven columns to the right.

When only three seconds remain in the first segment of the program, both the Current Segment column and the column to the right will flash and a tone will sound. In addition, if the speed and/or incline of the treadmill is about to change, the Speed display and/or the Distance/Incline display will flash to alert you, and three tones will sound. When the first segment is completed, all speed settings will move one column to the left. The speed setting for the second segment will then be shown in the flashing Current Segment column and the treadmill will automatically adjust to the speed and incline settings for the second segment.

The program will continue in this way until the speed setting for the final segment is shown in the Current Segment column and no time remains in the Time/Segment Time display. The walking belt will then slow to a stop.

Note: Each time a segment ends and the speed settings move one column to the left, if all of the indicators in the Current Segment column are lit, the speed settings will move downward so that only the highest indicators in the columns will appear in the program display. When the speed settings move to the left again and not all of the indicators in the Current Segment column are lit, the speed settings will move back up.

If the speed or incline setting for the current segment is too high or too low, you can manually override the setting by pressing the Speed or Incline buttons on the console. Every few times one of the Speed buttons is pressed, an additional indicator will light or darken in the Current Segment column. If any of the columns to the right of the Current Segment column have the same number of lit indicators as the Current Segment column, an additional indicator will light or darken in those columns as well. Note: If you manually adjust the speed setting so that all of the indicators in the Current Segment column are lit, the speed settings in the program display will not move downward as described above. **When the current segment of the program ends, the treadmill will automatically adjust to the speed and incline settings for the next segment.**

To stop the program temporarily, press the Stop button. All displays will pause and the Time/Segment Time display will begin to flash. To restart the program, press the Start button or the Speed + button. To end the program, press the Stop button, remove the key, and then reinsert the key.

4 Use the hand weights, if desired.

If one of the three cross training programs is selected, the Cross Training Indicator below the Time/Segment Time display will periodically flash.

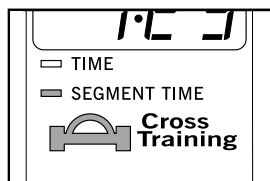

While the indicator is flashing, use the included hand weights for upper body exercise as you walk on the treadmill.

WARNING: Using hand weights and not holding the handrails may compromise your ability to maintain your balance. Exercises using hand weights should be attempted only by experienced users.

5 Follow your progress with the four displays.

Refer to step 5 on page 11.

6 When the program has ended, remove the key.

Step onto the foot rails and make sure that the incline of the treadmill is at the lowest setting. **The incline must be at the lowest setting when the treadmill is raised to the storage position.** Next, remove the key from the console and put it in a secure place. **Note: If the displays and indicators on the console remain lit after the key is removed, the console is in the “demo” mode. Refer to page 22 and turn off the demo mode.**

When you are finished using the treadmill, move the on/off switch near the power cord to the off position and unplug the power cord.

HOW TO USE THE PULSE PROGRAMS

WARNING: If you have heart problems, or if you are over 60 years of age and have been inactive, do not use the pulse programs. If you are taking medication regularly, consult your physician to find whether the medication will affect your exercise heart rate.

1 Insert the key into the console.

See HOW TO TURN ON THE POWER on page 10.

2 Put on the optional chest pulse sensor.

To use a pulse program, **you must wear the optional chest pulse sensor** (see page 22). To put on the chest pulse sensor, follow the instructions included with the chest pulse sensor.

3 Select one of the two pulse programs.

When the key is inserted, the manual mode will be selected. To select one of the pulse programs, press the Select Workout button repeatedly until one of the two pulse program indicators lights.

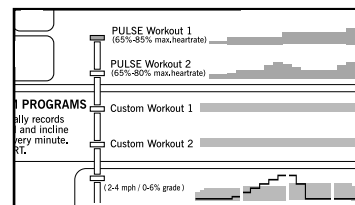

The profiles on the console show how the target heart rate will change during the programs. The program display will show a simplified profile of the program. The Time/Segment Time display will show how long the selected program will last.

4 Enter your age.

When a pulse program is selected, the word AGE will appear in the Pulse/Calories display.



If you have already entered your age, simply press the Enter button. If you have not entered your age, press the + or – button. The current age setting will then appear in the display. Press the buttons again to enter your age. The buttons can be held down to enter your age quickly. When your age is shown, press the Enter button.

5 Enter a maximum heart rate setting.

After you have entered your age, the letters PLS will appear in the Pulse/Calories display.

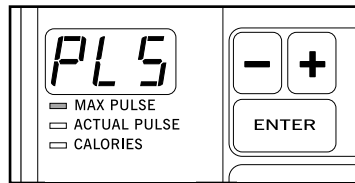

Press the + or – button. A number will then appear in the display. This number is the maximum heart rate setting for the program. If Pulse program 1 is selected, the maximum heart rate setting can be from 65% to 85% of your maximum possible heart rate; if Pulse program 2 is selected, the maximum heart rate setting can be from 65% to 80% of your maximum possible heart rate.

Note: Your maximum possible heart rate is estimated by subtracting your age from 220. For example, if you are 30 years old, your maximum possible heart rate is 190 ($220 - 30 = 190$). Therefore, if Pulse program 1 is selected, the maximum heart rate setting can be from 123 to 161 beats per minute (65% of 190 is 123; 85% of 190 is 161).

If you want to change the maximum heart rate setting, press the + and – buttons. The buttons can be held down to change the setting quickly. When the desired setting is shown, press the Enter button.

6 Press the Start button or the Speed + button to start the program.

A moment after the button is pressed, the treadmill will automatically adjust to the first speed and incline settings for the program. Hold the handrails and begin walking.

Each program is divided into several time segments of different lengths. The Time/Segment Time display will show both the time remaining in the program and the time remaining in the current segment. One target heart rate setting is programmed for each segment. The heart rate setting for the first segment will be shown in the flashing Current Segment column of the program display. The heart rate settings for the next seven segments will be shown in the seven columns to the right.

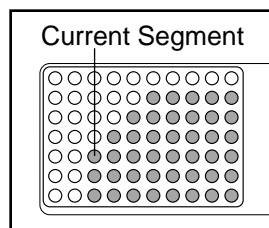

When only three seconds remain in the first segment of the program, both the Current Segment column and the column to the right will flash, a series of tones will sound, and the Speed display and the Distance/Incline display will flash. When the first segment is completed, all heart rate settings will move one column to the left. The heart rate setting for the second segment will then be shown in the flashing Current Segment column, and the speed and/or incline of the treadmill will change, if needed, to bring your heart rate closer to the heart rate setting for the second segment.

The program will continue until no time remains in the Time/Segment Time display. The walking belt will then slow to a stop.

If the speed or incline setting for the current segment is too high or too low, you can adjust the setting with the Speed or Incline buttons. However, if you decrease the speed, the incline will automatically increase; if you increase the speed, the incline will decrease. If you increase the incline, the speed will decrease; if you decrease the incline, the speed will increase. The treadmill will always attempt to keep your heart rate near the target heart rate setting for the current segment. Note: When the incline reaches the lowest setting, the speed cannot be increased any further. When the incline reaches the highest setting, the speed cannot be decreased any further.

If your pulse is not detected during the program, the letters PLS will flash in the Pulse/Calories display. In addition, the speed and/or incline of the treadmill may automatically decrease until your pulse is detected. If this occurs, refer to the instructions included with the chest pulse sensor.

Pulse programs cannot be stopped temporarily and then restarted. To stop the program at any time, press the Stop button.

7 Follow your progress with the four displays.

Refer to step 5 on page 11.

8 When the program has ended, remove the key.

See step 6 on page 13.

HOW TO CREATE CUSTOM PROGRAMS

1 Insert the key into the console.

See HOW TO TURN ON THE POWER on page 10.

2 Select one of the two custom programs.

When the key is inserted, the manual mode will be selected. To select one of the custom programs, press the Select Workout button repeatedly until one of the two custom program indicators lights.

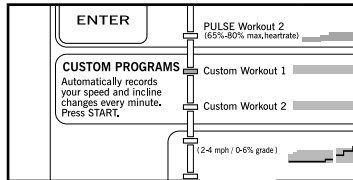

Note: If the custom program has not yet been defined, three columns of indicators will be lit in the program display. If more than three columns of indicators are lit, refer to HOW TO USE A CUSTOM PROGRAM on page 16.

3 Press the Start button or the Speed + button and program the desired speed and incline settings.

A moment after the button is pressed, the walking belt will begin to move. Hold the handrails and begin walking.

Refer to the program display. Each custom program is divided into one-minute segments. One speed setting and one incline setting can be programmed for each segment. The speed setting for the first segment will be shown in the flashing Current Segment column of the program display. (The incline settings are not shown in the program display.) To program a speed setting and an incline setting for the first segment, simply adjust the speed and incline of the treadmill to the desired

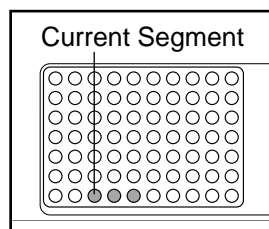

levels by pressing the Speed and Incline buttons. Every few times one of the Speed buttons is pressed, an additional indicator will light or darken in the Current Segment column.

When the first segment of the program is completed, the current speed setting and the current incline setting will be stored in memory. The three columns of indicators will then move one column to the left, and the speed setting for the second segment will be shown in the flashing Current Segment column. Program speed and incline settings for the second segment as described above. Note: After the third segment is completed, the columns of indicators in the program display will no longer move to the left. Instead, each time a segment is completed, the flashing Current Segment column will move one column to the right. If the Current Segment column reaches the right side of the program display, when the current segment is completed all columns of indicators in the program display will move three columns to the left.

Continue programming speed and incline settings for as many segments as desired; custom programs can have up to forty segments. When you are finished with your workout, press the Stop button twice. The speed and incline settings that you programmed and the number of segments that you programmed will then be saved in memory.

4 Follow your progress with the four displays.

Refer to step 5 on page 11.

5 When the program has ended, remove the key.

Refer to step 6 on page 13.

HOW TO USE CUSTOM PROGRAMS

1 Insert the key into the console.

See HOW TO TURN ON THE POWER on page 10.

2 Select one of the two custom programs.

When the key is inserted, the manual mode will be selected. To select one of the custom programs, press the Select Workout button repeatedly until one of the two custom program indicators lights.

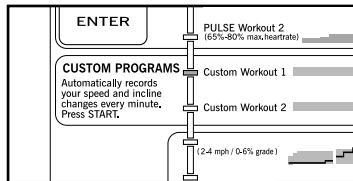

When a custom program is selected, the program display will show a simplified profile of the program. **Note: If only three columns of indicators are lit in the program display, refer to HOW TO CREATE A CUSTOM PROGRAM on page 15.**

3 Press the Start button or the Speed + button to start the program.

A moment after the button is pressed, the treadmill will automatically adjust to the first speed and incline settings for the program. Hold the handrails and begin walking.

Each custom program is divided into several one-minute segments. One speed setting and one incline setting are programmed for each segment. The speed setting for the first segment will be shown in the flashing Current Segment column of the program display. (The incline settings are not shown in the program display.) The speed settings for the next seven segments will be shown in the seven columns to the right.

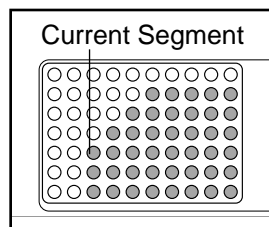

When only three seconds remain in the first segment of the program, both the Current Segment column and the column to the right will flash and a tone will sound. In addition, if the speed and/or incline of the treadmill is about to change, the Speed display and/or the Distance/Incline display

will flash to alert you, and three tones will sound. When the first segment is completed, all speed settings will move one column to the left. The speed setting for the second segment will then be shown in the flashing Current Segment column and the treadmill will automatically adjust to the speed and incline settings for the second segment.

The program will continue until the speed setting for the final segment is shown in the Current Segment column and no time remains in the Time/Segment Time display. The walking belt will then slow to a stop.

If desired, you can redefine to the program while using the program. **To change the speed or incline setting during the current segment**, simply press the Speed or Incline buttons. When the current segment is completed, the new setting will be saved in memory. **To increase the length of the program**, first wait until the program is completed. Then, press the Start button and program speed and incline settings for as many additional segments as desired. (Note: While you are adding segments to the program, the speed settings in the program display will not move to the left. Instead, each time a segment is completed, the flashing Current Segment column will move one column to the right. If the Current Segment column reaches the right side of the program display, when the current segment is completed, all columns of indicators in the program display will move three columns to the left.) When you have added as many segments as desired, press the Stop button twice. **To decrease the length of the program**, press the Stop button twice at any time before the program is completed.

To stop the program temporarily, press the Stop button. All displays will pause and the Time/Segment Time display will begin to flash. To restart the program, press the Start button. To end the program before it is completed, press the Stop button, remove the key, and then reinsert the key.

4 Follow your progress with the four displays.

Refer to step 5 on page 11.

5 When the program has ended, remove the key.

Refer to step 6 on page 13.

HOW TO CONNECT THE TREADMILL TO YOUR CD PLAYER, VCR, OR COMPUTER

To use **iFIT.com CDs**, the treadmill must be connected to your portable CD player, portable stereo, home stereo, or computer with CD player. See pages 17 and 18 for connecting instructions. To use **iFIT.com videocassettes**, the treadmill must be connected to your VCR. See page 19 for connecting instructions. To use **iFIT.com programs directly from our Web site**, the treadmill must be connected to your home computer. See page 18 for connecting instructions.

HOW TO CONNECT YOUR PORTABLE CD PLAYER

Note: If your CD player has separate **LINE OUT** and **PHONES** jacks, see instruction A below. If your CD player has only one jack, see instruction B.

- A. Plug one end of the audio cable into the jack on the front of the treadmill near the power cord. Plug the other end of the cable into the **LINE OUT** jack on your CD player. Plug your headphones into the **PHONES** jack.

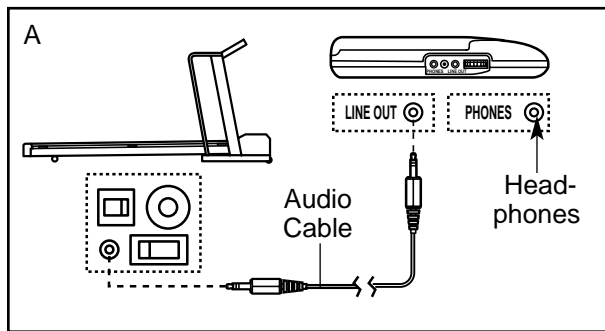

- B. Plug one end of the audio cable into the jack on the front of the treadmill near the power cord. Plug the other end of the cable into a 3.5mm Y-adapter (available at electronics stores). Plug the Y-adapter into the **PHONES** jack on your CD player. Plug your headphones into the other side of the Y-adapter.

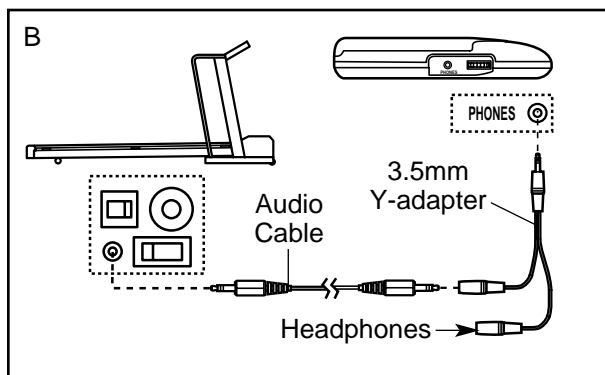

HOW TO CONNECT YOUR PORTABLE STEREO

Note: If your stereo has an **RCA-type AUDIO OUT** jack, see instruction A below. If your stereo has a **3.5mm LINE OUT** jack, see instruction B. If your stereo has only a **PHONES** jack, see instruction C.

- A. Plug one end of the audio cable into the jack on the front of the treadmill near the power cord. Plug the other end of the cable into the included adapter. Plug the adapter into an **AUDIO OUT** jack on your stereo.

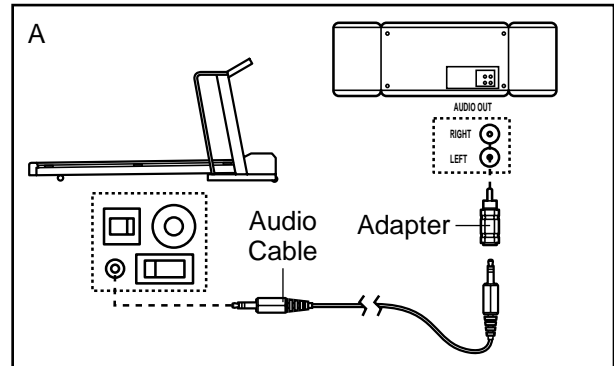

- B. Plug one end of the audio cable into the jack on the front of the treadmill near the power cord. Plug the other end of the cable into the **LINE OUT** jack on your stereo.

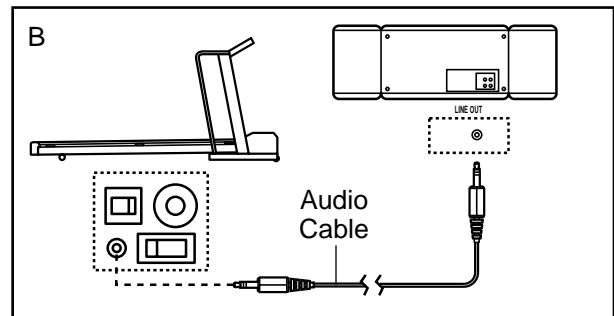

- C. Plug one end of the audio cable into the jack on the front of the treadmill near the power cord. Plug the other end of the cable into a 3.5mm Y-adapter (available at electronics stores). Plug the Y-adapter into the **PHONES** jack on your stereo. Plug your headphones into the other side of the Y-adapter.

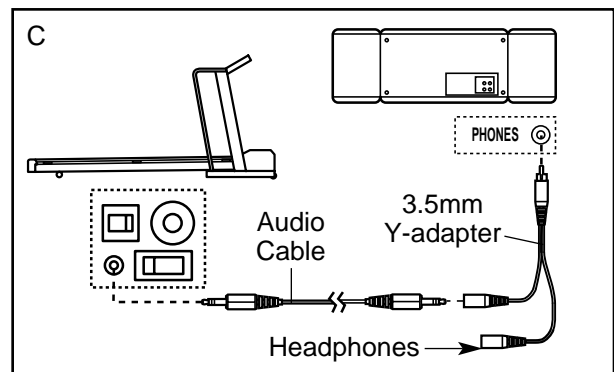

HOW TO CONNECT YOUR HOME STEREO

Note: If your stereo has an unused **LINE OUT** jack, see instruction **A** below. If the **LINE OUT** jack is being used, see instruction **B**.

- A. Plug one end of the audio cable into the jack on the front of the treadmill near the power cord. Plug the other end of the cable into the included adapter. Plug the adapter into the **LINE OUT** jack on your stereo.

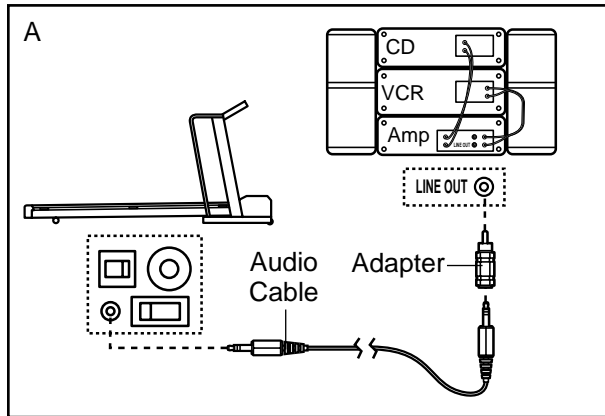

- B. Plug one end of the audio cable into the jack on the front of the treadmill near the power cord. Plug the other end of the cable into the included adapter. Plug the adapter into an **RCA Y-adapter** (available at electronics stores). Next, remove the wire that is currently plugged into the **LINE OUT** jack on your stereo and plug the wire into the unused side of the **Y-adapter**. Plug the **Y-adapter** into the **LINE OUT** jack on your stereo.

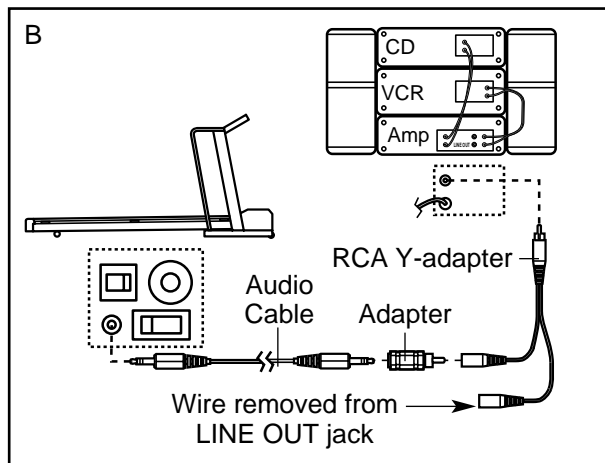

HOW TO CONNECT YOUR COMPUTER

Note: If your computer has a **3.5mm LINE OUT** jack, see instruction **A**. If your computer has only a **PHONES** jack, see instruction **B**.

- A. Plug one end of the audio cable into the jack on the front of the treadmill near the power cord. Plug the other end of the cable into the **LINE OUT** jack on your computer.

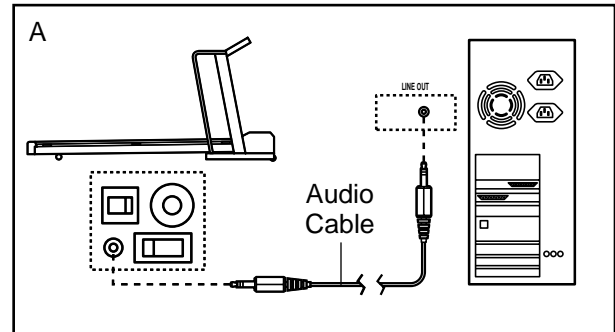

- B. Plug one end of the audio cable into the jack on the front of the treadmill near the power cord. Plug the other end of the cable into a **3.5mm Y-adapter** (available at electronics stores). Plug the **Y-adapter** into the **PHONES** jack on your computer. Plug your headphones or speakers into the other side of the **Y-adapter**.

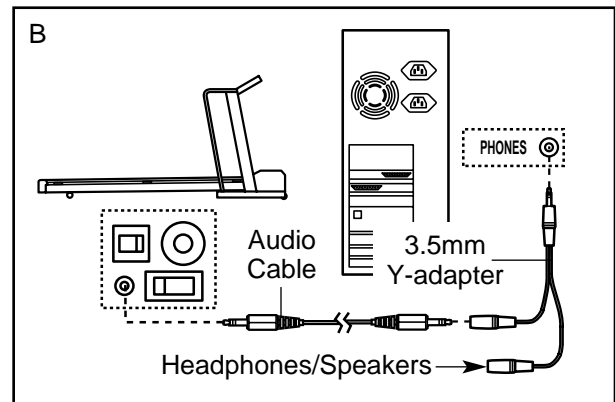

HOW TO CONNECT YOUR VCR

Note: If your VCR has an unused AUDIO OUT jack, see instruction A below. If the AUDIO OUT jack is being used, see instruction B. If you have a TV with a built-in VCR, see instruction B. If your VCR is connected to your home stereo, see **HOW TO CONNECT YOUR HOME STEREO** on page 18.

- A. Plug one end of the audio cable into the jack on the front of the treadmill near the power cord. Plug the other end of the cable into the included adapter. Plug the adapter into the AUDIO OUT jack on your VCR.

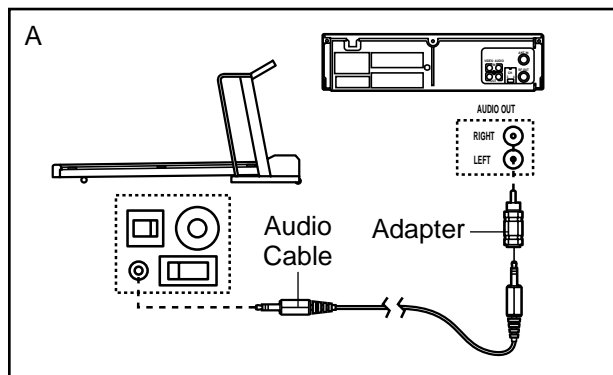

- B. Plug one end of the audio cable into the jack on the front of the treadmill near the power cord. Plug the other end of the cable into the included adapter. Plug the adapter into an RCA Y-adapter (available at electronics stores). Next, remove the wire that is currently plugged into the AUDIO OUT jack on your VCR and plug the wire into the unused side of the Y-adapter. Plug the Y-adapter into the AUDIO OUT jack on your VCR.

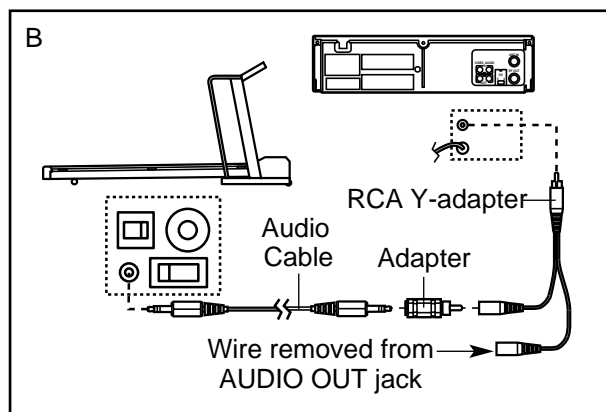

HOW TO USE iFIT.COM CD AND VIDEO PROGRAMS

To use iFIT.com CDs or videocassettes, the treadmill must be connected to your portable CD player, portable stereo, home stereo, computer with CD player, or VCR. See **HOW TO CONNECT THE TREADMILL TO YOUR CD PLAYER, VCR, OR COMPUTER** on page 17. **Note:** To purchase iFIT.com CDs or iFIT.com videocassettes, call toll-free 1-800-735-0768.

Follow the steps below to use an iFIT.com CD or video program.

1 Insert the key into the console.

See **HOW TO TURN ON THE POWER** on page 10.

2 Select the iFIT.com mode.

When the key is inserted, the manual mode will be selected. To use iFIT.com CDs or videocassettes, press the iFIT.com button. The iFIT.com indicator will light.

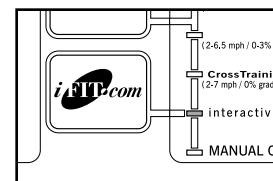

3 Insert the iFIT.com CD or videocassette.

If you are using an iFIT.com CD, insert the CD into your CD player. If you are using an iFIT.com videocassette, insert the videocassette into your VCR.

4 Press the PLAY button on your CD player or VCR.

A moment after the button is pressed, your personal trainer will begin guiding you through your workout. Simply follow your personal trainer's instructions. Note: If the Time/Segment Time display is flashing, press the Start button or the Speed + button on the console. The treadmill will not respond to a CD or video program when the Time/Segment Time display is flashing.

During the CD or video program, an electronic "chirping" sound will alert you when the speed and/or incline of the treadmill is about to change.

CAUTION: Always listen for the "chirp" and be prepared for speed and/or incline changes. In some instances, the speed and/or incline may change before the personal trainer describes the change.

If the speed or incline settings are too high or too low, you can manually override the settings at any time by pressing the Speed or Incline buttons on the console. However, **when the next “chirp” is heard, the speed and/or incline will change to the next settings of the CD or video program.**

To stop the walking belt at any time, press the Stop button on the console. The Time/Segment Time display will begin to flash. To restart the program, press the Start button or the Speed + button. After a moment, the walking belt will begin to move at 1.0 mph. **When the next “chirp” is heard, the speed and incline will change to the next settings of the CD or video program.** The program can also be stopped by pressing the Stop button on your CD player or VCR.

When the CD or video program is completed, the walking belt will stop and the Time/Segment Time display will begin to flash. Note: To use another CD or video program, press the Stop button or remove the key and go to step 1 on page 19.

Note: If the speed or incline of the treadmill does not change when a “chirp” is heard:

- **Make sure that the iFIT.com indicator is lit and that the Time/Segment Time display is not flashing. If the Time/Segment Time display is flashing, press the Start button or the Speed + button on the console.**

- **Adjust the volume of your CD player or VCR. If the volume is too high or too low, the console may not detect the program signals.**
- **Make sure that the audio cable is properly connected, that it is fully plugged in, and that it is not wrapped around a power cord.**
- **If you are using your portable CD player and the CD skips, set the CD player on the floor or another flat surface instead of on the console.**

5 Follow your progress with the four displays.

See step 5 on page 11.

6 When the program is completed, remove the key.

See step 6 on page 13.

CAUTION: Always remove iFIT.com CDs and videos from your CD player or VCR when you are not using them.

HOW TO USE PROGRAMS DIRECTLY FROM OUR WEB SITE

Our Web site at www.iFIT.com allows you to access basic programs, audio programs, and video programs directly from the internet. Additional options, such as on-line competitions, personal training sessions via the internet, and online tracking of your workout history are soon to be available. See www.iFIT.com for details.

To use programs from our Web site, the treadmill must be connected to your home computer. See HOW TO CONNECT YOUR COMPUTER on page 18. In addition, you must have an internet connection and an internet service provider. A list of specific system requirements will be found on our Web site.

Follow the steps below to use a program from our Web site.

1 Insert the key into the console.

See HOW TO TURN ON THE POWER on page 10.

2 Select the iFIT.com mode.

When the key is inserted, the manual mode will be selected. To use a program from our Web site, press the iFIT.com button. The iFIT.com indicator will light.

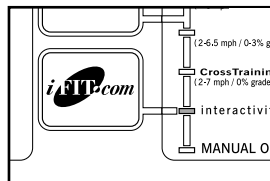

3 Go to your computer and start an internet connection.

4 Start your web browser, if necessary, and go to our Web site at www.iFIT.com.

5 Follow the desired links on our Web site to select a program.

Read and follow the on-line instructions for using a program.

6 Follow the on-line instructions to start the program.

When you start the program, an on-screen countdown will begin.

7 Return to the treadmill and stand on the foot rails. Find the clip attached to the key and slide the clip onto the waistband of your clothes.

When the on-screen countdown ends, the program will begin and the walking belt will begin to move. Hold the handrails, step onto the walking belt, and begin walking. During the program, an electronic “chirping” sound will alert you when the speed and/or incline of the treadmill is about to change. **CAUTION: Always listen for the “chirp” and be prepared for speed and/or incline changes.**

If the speed or incline settings are too high or too low, you can manually override the settings at any time by pressing the Speed or Incline buttons on the console. **However, when the next “chirp” is heard, the speed and/or incline will change to the next settings for the program.**

To stop the walking belt at any time, press the Stop button on the console. The Time/ Segment Time display will begin to flash. To restart the program, press the Start button or the Speed + button. After a moment, the walking belt will begin to move at 1.0 mph. **When the next “chirp” is heard, the speed and incline will change to the next settings for the program.**

When the program is completed, the walking belt will stop and the Time/Segment Time display will begin to flash. Note: To use another program, press the Stop button and go to step 5.

Note: If the speed or incline of the treadmill does not change when a “chirp” is heard, make sure that the iFIT.com indicator is lit and that the Time/Segment Time display is not flashing. In addition, make sure that the audio cable is properly connected, that it is fully plugged in, and that it is not wrapped around a power cord.

8 Follow your progress with the four displays.

See step 5 on page 11.

9 When the program has ended, remove the key.

See step 6 on page 13.

THE INFORMATION MODE/DEMO MODE

The console features an information mode that keeps track of the total number of hours that the treadmill has been operated and the total number of miles that the walking belt has moved. The information mode also allows you to switch the console from miles per hour to kilometers per hour. In addition, the information mode allows you to turn on and turn off the demo mode.

To select the information mode, hold down the Stop button while inserting the key into the console. When the information mode is selected, the following information will be shown:

The Time/Segment Time display will show the total number of hours that the treadmill has been used.

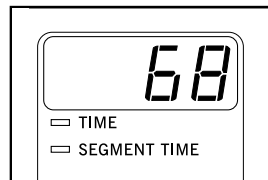

The Distance/Incline display will show the total number of miles that the walking belt has moved.

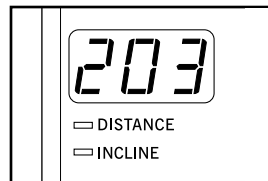

An E for English miles or an M for metric kilometers will appear in the Speed display. Press the Speed + button to change the unit of measurement.

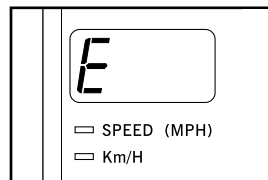

IMPORTANT: The Pulse/Calories display should be blank. If a “d” appears in the display, the console is in the “demo” mode. This mode is intended to be used only

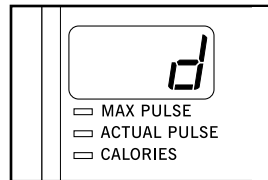

when a treadmill is displayed in a store. When the console is in the demo mode, the power cord can be plugged in, the key can be removed from the console, and the displays and indicators on the console will automatically light in a preset sequence, although the buttons on the console will not operate. **If a “d” appears in the Pulse/Calories display when the information mode is selected, press the Speed – button so the Pulse/Calories display is blank.**

To exit the information mode, remove the key from the console.

THE OPTIONAL CHEST PULSE SENSOR

An optional chest pulse sensor adds even more features to the console. The chest pulse sensor continuously monitors your heart rate during your workouts and allows you to use the console’s two pulse programs. **To purchase the optional chest pulse sensor, call toll-free 1-800-734-2377.**

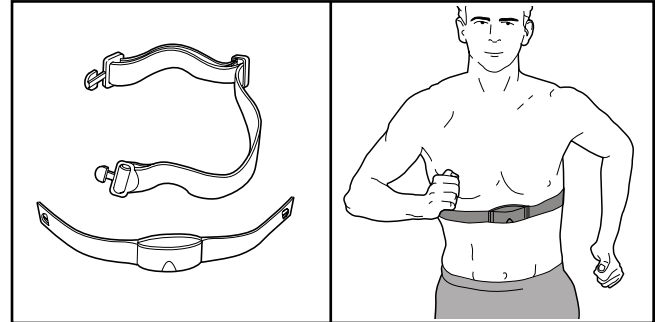

HOW TO FOLD AND MOVE THE TREADMILL

HOW TO FOLD THE TREADMILL FOR STORAGE

Before folding the treadmill, adjust the incline to the lowest position. If this is not done, the treadmill may be permanently damaged. Next, unplug the power cord. **CAUTION:** You must be able to safely lift 45 pounds (20 kg) to raise, lower, or move the treadmill.

1. Hold the treadmill in the locations shown at the right. **To decrease the possibility of injury, bend your legs and keep your back straight. As you raise the treadmill, make sure to lift with your legs rather than your back.** Raise the treadmill about halfway to the vertical position.

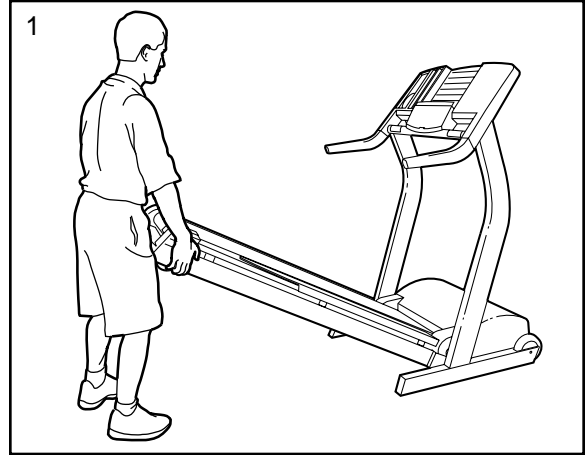

2. Move your right hand to the position shown and hold the treadmill firmly. Using your left hand, pull the lock knob to the left and hold it. Raise the treadmill until all parts of the treadmill are past the latch pin. Then, release the lock knob. **Make sure that the lock knob is fully released so that the latch pin is securely holding the catch.**

To protect the floor or carpet from damage, place a mat under the treadmill. Keep the treadmill out of direct sunlight. Do not leave the treadmill in the storage position in temperatures above 85° Fahrenheit.

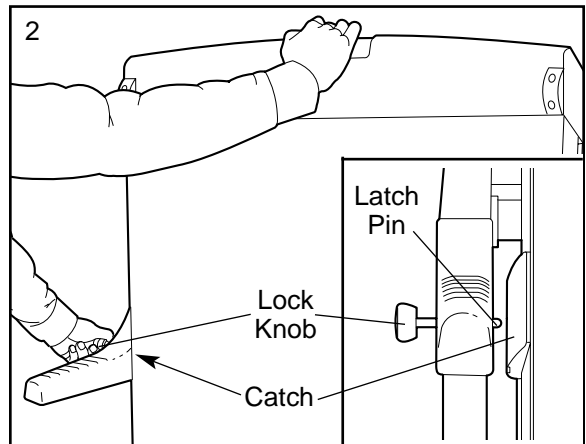

HOW TO MOVE THE TREADMILL

Before moving the treadmill, convert the treadmill to the storage position as described above. **Make sure that the latch pin is securely holding the catch.**

1. Hold the handrails and place one foot on the base.
2. Tilt the treadmill back until it rolls freely on the wheels. Carefully move the treadmill to the desired location. **To reduce the risk of injury, use extreme caution while moving the treadmill. Do not attempt to move the treadmill over an uneven surface.**
3. Place one foot on the wheel, and carefully lower the treadmill until the base is resting in the storage position.

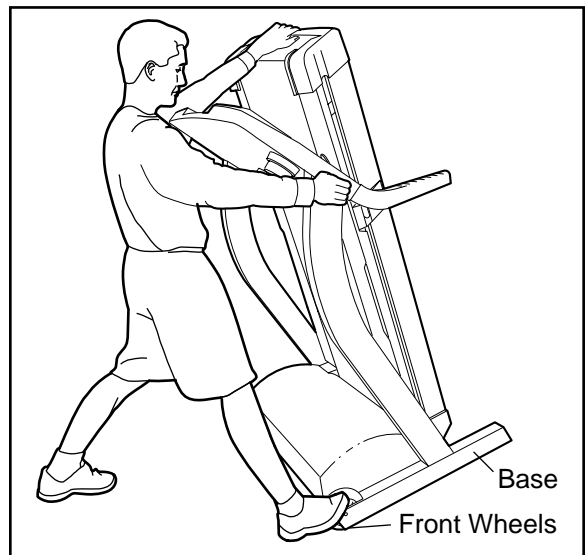

HOW TO LOWER THE TREADMILL FOR USE

1. Hold the upper end of the treadmill with your right hand as shown. Using your left hand, pull the latch knob to the left and hold it. Pivot the treadmill down until the catch is past the pin. Slowly release the latch knob.

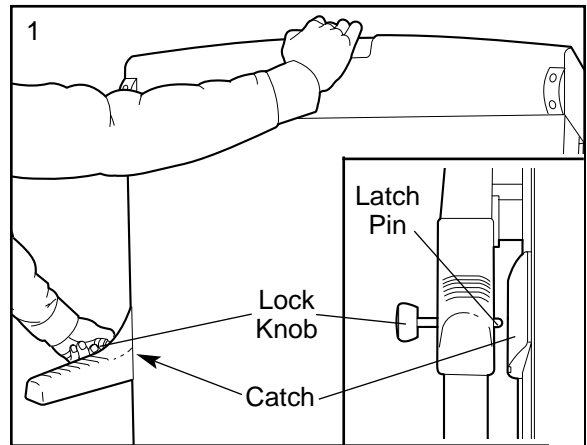

2. Hold the treadmill firmly with both hands, and lower the treadmill to the floor. **Do not drop the treadmill frame to the floor. CAUTION: To decrease the possibility of injury, bend your legs and keep your back straight.**

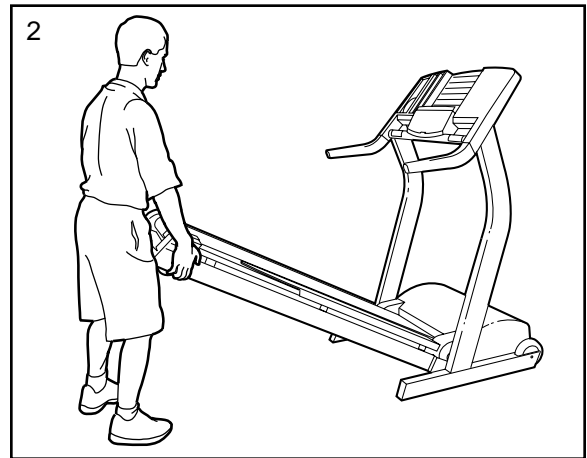

TROUBLE-SHOOTING AND MAINTENANCE

Most treadmill problems can be solved by following the instructions below. If further assistance is needed, please call our Customer Service Department toll-free at 1-800-999-3756, Monday through Friday, 6 a.m. until 6 p.m. Mountain Time (excluding holidays).

PROBLEM

SOLUTION

1. The power does not turn on

- Make sure that the power cord is plugged into a surge suppressor, and that the surge suppressor is plugged into a properly grounded outlet (see page 7). Use only a single-outlet surge suppressor that is UL 1449 listed as a transient voltage surge suppressor (TVSS). The surge suppressor must have a UL suppressed voltage rating of 400 volts or less and a minimum surge dissipation of 450 joules. The surge suppressor must be electrically rated for 120 volts AC and 15 amps. Important: The treadmill is not compatible with GFCI-equipped outlets.
- Make sure that the key is fully inserted into the console.
- Check the circuit breaker located on the frame near the power cord. If the switch protrudes as shown, the circuit breaker has tripped. To reset the circuit breaker, wait for five minutes and then press the switch back in.
- Check the on/off switch located on the frame near the power cord. The switch must be in the on position.

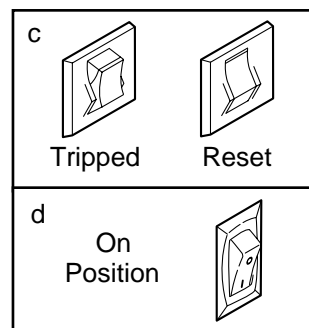

2. The power turns off during use

- Check the circuit breaker located on the treadmill frame near the power cord (see 1. c. above). If the circuit breaker has tripped, wait for five minutes and then press the switch back in.
- Make sure that the power cord is plugged in.
- Remove the key from the console and then reinsert it.
- Unplug the power cord, wait for five minutes, and then plug the power cord back in.
- Make sure that the on/off switch is in the on position (see 1. d. above).

3. The walking belt slows when walked on

- Make sure that only an appropriate surge suppressor is used (see 1. a. above).
- If the walking belt is overtightened, treadmill performance may decrease and the walking belt may be permanently damaged. Remove the key and **UNPLUG THE POWER CORD**. Using the included allen wrench, turn both rear roller adjustment bolts counterclockwise 1/4 of a turn. When the walking belt is properly tightened, you should be able to lift **the edges** of the walking belt 3 to 4 inches off the walking platform. Be careful to keep the walking belt centered. Plug in the power cord, insert the key and run the treadmill for a few minutes. Repeat until the walking belt is properly tightened.

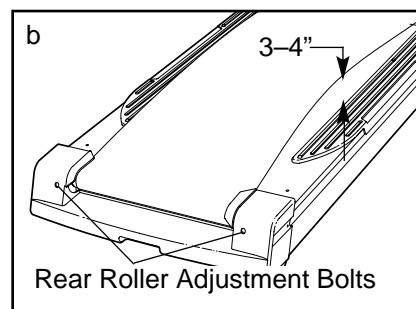

PROBLEM**SOLUTION**

4. The walking belt is off-center or slips when walked on

a. **If the walking belt has shifted to the left**, first remove the key and **UNPLUG THE POWER CORD**. Using the allen wrench, turn the left rear roller bolt clockwise 1/2 of a turn. Be careful not to overtighten the walking belt. **If the walking belt has shifted to the right**, turn the left rear roller bolt counterclockwise 1/2 of a turn. Plug in the power cord, insert the key and run the treadmill for a few minutes. Repeat until the walking belt is centered.

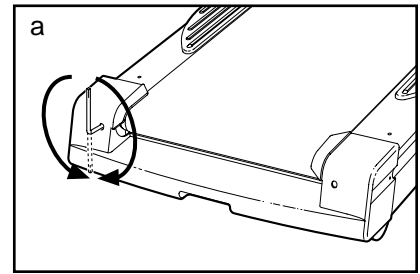

b. If the walking belt slips when walked on, first remove the key and **UNPLUG THE POWER CORD**. Using the allen wrench, turn both rear roller bolts clockwise 1/4 of a turn. When the walking belt is correctly tightened, you should be able to lift each side of the walking belt 3 to 4 inches off the walking platform. Be careful to keep the walking belt centered. Plug in the power cord, insert the key and carefully walk on the treadmill for a few minutes. Repeat until the walking belt is properly tightened.

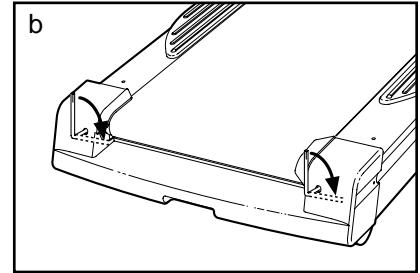

5. The displays of the console do not function properly

a. Remove the key from the console and **UNPLUG THE POWER CORD**. Next, remove the screws from the hood and carefully remove the hood. Locate the Reed Switch (17) and the Magnet (12) on the left side of the Pulley (11). Turn the Pulley until the Magnet is aligned with the Reed Switch. **Make sure that the gap between the Magnet and the Reed Switch is about 1/8"**. If necessary, loosen the Reed Switch Screw (99) and move the Reed Switch slightly. Retighten the Screw. Re-attach the hood and run the treadmill for a few minutes to check for a correct speed reading.

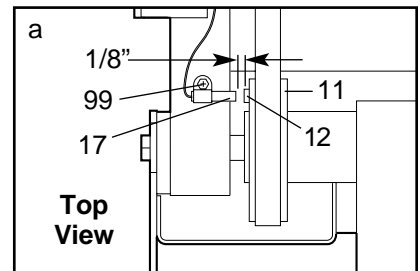

NOTES

EXERCISE GUIDELINES

⚠️ WARNING: Before beginning this or any exercise program, consult your physician. This is especially important for individuals over the age of 35 or individuals with pre-existing health problems.

The pulse sensor is not a medical device. Various factors, including your movement, may affect the accuracy of heart rate readings. The sensor is intended only as an exercise aid in determining heart rate trends in general.

The following guidelines will help you to plan your exercise program. For more detailed exercise information, obtain a reputable book or consult your physician.

EXERCISE INTENSITY

Whether your goal is to burn fat or to strengthen your cardiovascular system, the key to achieving the desired results is to exercise with the proper intensity. The proper intensity level can be found by using your heart rate as a guide. The chart below shows recommended heart rates for fat burning and aerobic exercise.

HEART RATE TRAINING ZONES							
AEROBIC	165	155	145	140	130	125	115
MAX FAT BURN	145	138	130	125	118	110	103
FAT BURN	125	120	115	110	105	95	90
Age	20	30	40	50	60	70	80

To find the proper heart rate for you, first find your age near the bottom of the chart (ages are rounded off to the nearest ten years). Next, find the three numbers above your age. The three numbers define your “training zone.” The lower two numbers are recommended heart rates for fat burning; the highest number is the recommended heart rate for aerobic exercise.

To measure your heart rate during exercise, use the handgrip pulse sensor or the optional chest pulse sensor (see page 22). If your heart rate is too high or too low, adjust the speed or incline of the treadmill.

Fat Burning

To burn fat effectively, you must exercise at a relatively low intensity level for a sustained period of time. During the first few minutes of exercise, your body

uses easily accessible carbohydrate calories for energy. Only after the first few minutes does your body begin to use stored fat calories for energy. If your goal is to burn fat, adjust the speed or incline of the treadmill until your heart rate is near the lowest number in your training zone.

For maximum fat burning, adjust the speed or incline of the treadmill until your heart rate is near the middle number in your training zone.

Aerobic Exercise

If your goal is to strengthen your cardiovascular system, your exercise must be “aerobic.” Aerobic exercise is activity that requires large amounts of oxygen for prolonged periods of time. This increases the demand on the heart to pump blood to the muscles, and on the lungs to oxygenate the blood. For aerobic exercise, adjust the speed or incline of the treadmill until your heart rate is near the highest number in your training zone.

WORKOUT GUIDELINES

Each workout should include the following three parts:

A Warm-up—Start each workout with 5 to 10 minutes of stretching and light exercise. A proper warm-up increases your body temperature, heart rate and circulation in preparation for exercise.

Training Zone Exercise—After warming up, increase the intensity of your exercise until your pulse is in your training zone for 20 to 60 minutes. (During the first few weeks of your exercise program, do not keep your pulse in your training zone for longer than 20 minutes.) Breathe regularly and deeply as you exercise—never hold your breath.

A Cool-down—Finish each workout with 5 to 10 minutes of stretching to cool down. This will increase the flexibility of your muscles and will help prevent post-exercise problems.

EXERCISE FREQUENCY

To maintain or improve your condition, complete three workouts each week, with at least one day of rest between workouts. After a few months, you may complete up to five workouts each week if desired. The key to success is to make exercise a regular and enjoyable part of your everyday life.

SUGGESTED STRETCHES

The correct form for several basic stretches is shown at the right. Move slowly as you stretch—never bounce.

1. Toe Touch Stretch

Stand with your knees bent slightly and slowly bend forward from your hips. Allow your back and shoulders to relax as you reach down toward your toes as far as possible. Hold for 15 counts, then relax. Repeat 3 times. Stretches: Hamstrings, back of knees and back.

2. Hamstring Stretch

Sit with one leg extended. Bring the sole of the opposite foot toward you and rest it against the inner thigh of your extended leg. Reach toward your toes as far as possible. Hold for 15 counts, then relax. Repeat 3 times for each leg. Stretches: Hamstrings, lower back and groin.

3. Calf/Achilles Stretch

With one leg in front of the other, reach forward and place your hands against a wall. Keep your back leg straight and your back foot flat on the floor. Bend your front leg, lean forward and move your hips toward the wall. Hold for 15 counts, then relax. Repeat 3 times for each leg. To cause further stretching of the achilles tendons, bend your back leg as well. Stretches: Calves, achilles tendons and ankles.

4. Quadriceps Stretch

With one hand against a wall for balance, reach back and grasp one foot with your other hand. Bring your heel as close to your buttocks as possible. Hold for 15 counts, then relax. Repeat 3 times for each leg. Stretches: Quadriceps and hip muscles.

5. Inner Thigh Stretch

Sit with the soles of your feet together and your knees outward. Pull your feet toward your groin area as far as possible. Hold for 15 counts, then relax. Repeat 3 times. Stretches: Quadriceps and hip muscles.

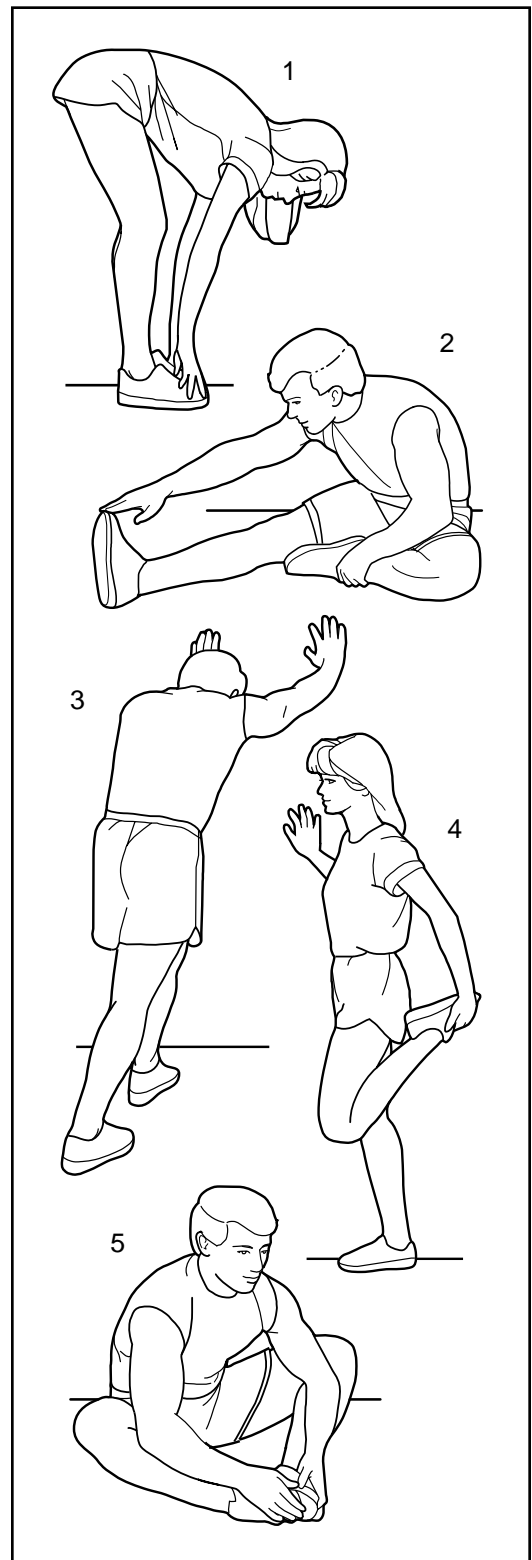

PART LIST—Model No. HRTL14910

R1201A

To locate the parts listed below, refer to the EXPLODED DRAWING attached in the center of this manual.

Key No.	Qty.	Description	Key No.	Qty.	Description	Key No.	Qty.	Description
1	1	Left Foot Rail	49	4	Isolator Washer	96	2	Tie
2	1	Right Foot Rail	50	4	Isolator Nut	97	5	8" Cable Tie
3*	1	Idler Assembly	51**	1	Chest Pulse Strap	98	4	Bumper
4	4	Isolator	52	2	Roller Adj. Washer	99	4	Bumper Screw
5	1	Latch Catch	53	2	Rear Roller Adj. Bolt	100	1	On/Off Switch
6	1	Platform	54	1	Rear Endcap	101	1	Circuit Breaker
7	4	Walking Deck Screw	55	1	Frame	102	1	Power Cord
8	1	Walking Belt	56	1	Allen Wrench	103	1	Power Cord Grommet
9	2	Frame Pivot Bolt	57	2	Rear Platform Screw	104	2	Warning Decal
10	1	Latch Assembly	58	1	Rear Roller	105	20	Foot Rail Screw
11	1	Front Roller/Pulley	59	1	Pulse Wire Harness	106	1	Jack
12	1	Magnet	60	2	Frame Star Washer	107	1	iFIT.com Audio Cable
13	7	Front Wheel Nut/ Pivot Nut	61	1	Book Rack	108	6	Foam Grip Screw/ Belt Guide Screw
14	2	Spacer Insert	62	1	Left Foam Grip	109	2	2-pound Weight
15	2	Frame Pivot Spacer	63	2	Roller Star Washer	110	2	Foam Pad
16	1	Reed Switch Clip	64	1	Pulse Sensor	111	1	12" Audio Wire
17	1	Reed Switch	65	1	Upright	112	1	Tension Washer
18	1	Lift Frame	66	4	Base Mounting Screw	113	1	Tension Bolt
19	4	Wire Clip	67	1	Lock Knob	114	4	Frame Pivot Washer
20	1	Idler Arm	68	1	Lock Knob Sleeve	115	1	Console Ground Wire
21	2	Pulse Bar Bolt	69	1	Lock Knob Spring	116	1	Motor Plate
22	1	Motor Belt	70	1	Lock Pin Collar	117	2	Motor Isolator
23	1	Idler Pulley	71	1	Pin Clip	118	1	Audio Wire Nut
24	1	Motor	72	1	Lock Pin	119	2	Outlet Bracket
25	1	Pulley Spacer	73	2	Incline Pivot Bolt	120	4	Star Washer
26	2	Static Warning Decal	74	1	Wire Harness	121	4	Controller Screw
27	4	Hood Bracket	75	8	Grommet	122	1	Lift Motor Screw/ Base Screw
28	1	Pulley Nut	76	2	Console Screw	123	4	Hood Screw
29	1	Idler Spring	77	2	Wheel Spacer	124	3	Long Console Screw
30	2	Lift Motor Nut	78	2	Front Wheel	125	1	Idler Pulley Bolt
31	1	Lift Motor Bolt	79	2	Wheel Bolt	#	4	Front Belly Pan Screw
32	1	Lift Motor Bolt	80	1	Wheel Nut	#	1	14" White Wire, 2 F
33	2	Motor Bolt	81	1	Right Foam Grip	#	1	8" White Wire, M/F
34	1	Outlet Bracket	82	1	Console Base (Top)	#	1	8" Blue Wire, 2 F
35	4	Plastic Stand-off	83	1	Console	#	1	8" Blue Wire, M/F
36	1	Power Supply	84	1	Key/Clip	#	1	4" Black Wire, 2 F
37	1	Power Supply Bracket	85	1	Console Base (Bottom)	#	1	8" Green Wire, 2 Ring
38	1	Controller	86	1	Pulse Sensor Plate	#	1	User's Manual
39	1	Controller Bracket	87	1	Upright Wire Harness			
40	1	Motor Hood	88	1	Shock			
41	6	Latch Catch Screw/ Rear Endcap Screw	89	2	Upright Endcap			
42	1	Motor Belly Pan	90	5	Pulley Washer/ Wheel Washer			
43	2	Belt Guide	91	1	Wheel Washer			
44	21	Misc. Screw	92	1	Pulse Sensor Cover			
45	13	Plastic Fastener	93	1	Latch Warning Decal			
46	1	Frame Belly Pan	94	1	Incline Motor			
47	1	Pulse Bar	95	1	12" Wire Harness			
48	1	Ground Wire		2	Incline Motor Spacer			
49	2	Rear Foot		6	Sensor Cover Screw/ Rear Foot			
				2	Tie Holder			

* Includes all parts shown in the box

**For information about the optional chest pulse sensor, see page 22

These parts are not illustrated

HOW TO ORDER REPLACEMENT PARTS

To order replacement parts, call our Customer Service Department toll-free at 1-800-999-3756, Monday through Friday, 6 a.m. until 6 p.m. Mountain Time (excluding holidays). To help us assist you, please be prepared to give the following information:

- The MODEL NUMBER of the product (HRTL14910)
- The NAME of the product (HealthRider® S700HRC treadmill)
- The SERIAL NUMBER of the product (see the front cover of this manual)
- The KEY NUMBER and DESCRIPTION of the part(s) (see the PART LIST on page 30).

EXPLODED DRAWING—Model No. HRTL14910

R1201A

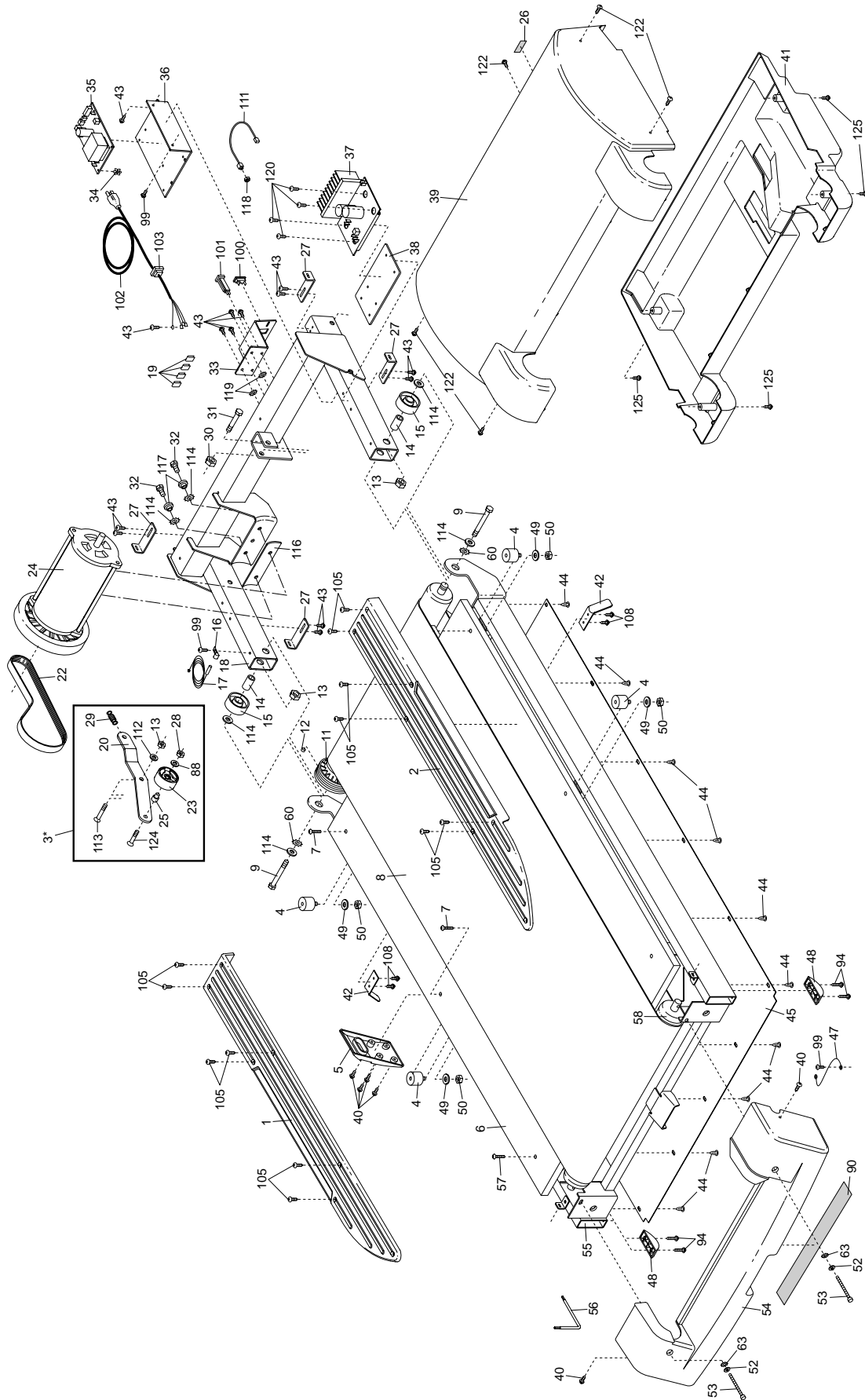

To identify the parts shown on this EXPLODED DRAWING, refer to the PART LIST on page 30.

EXPLODED DRAWING—Model No. HRTL14910

R1201A

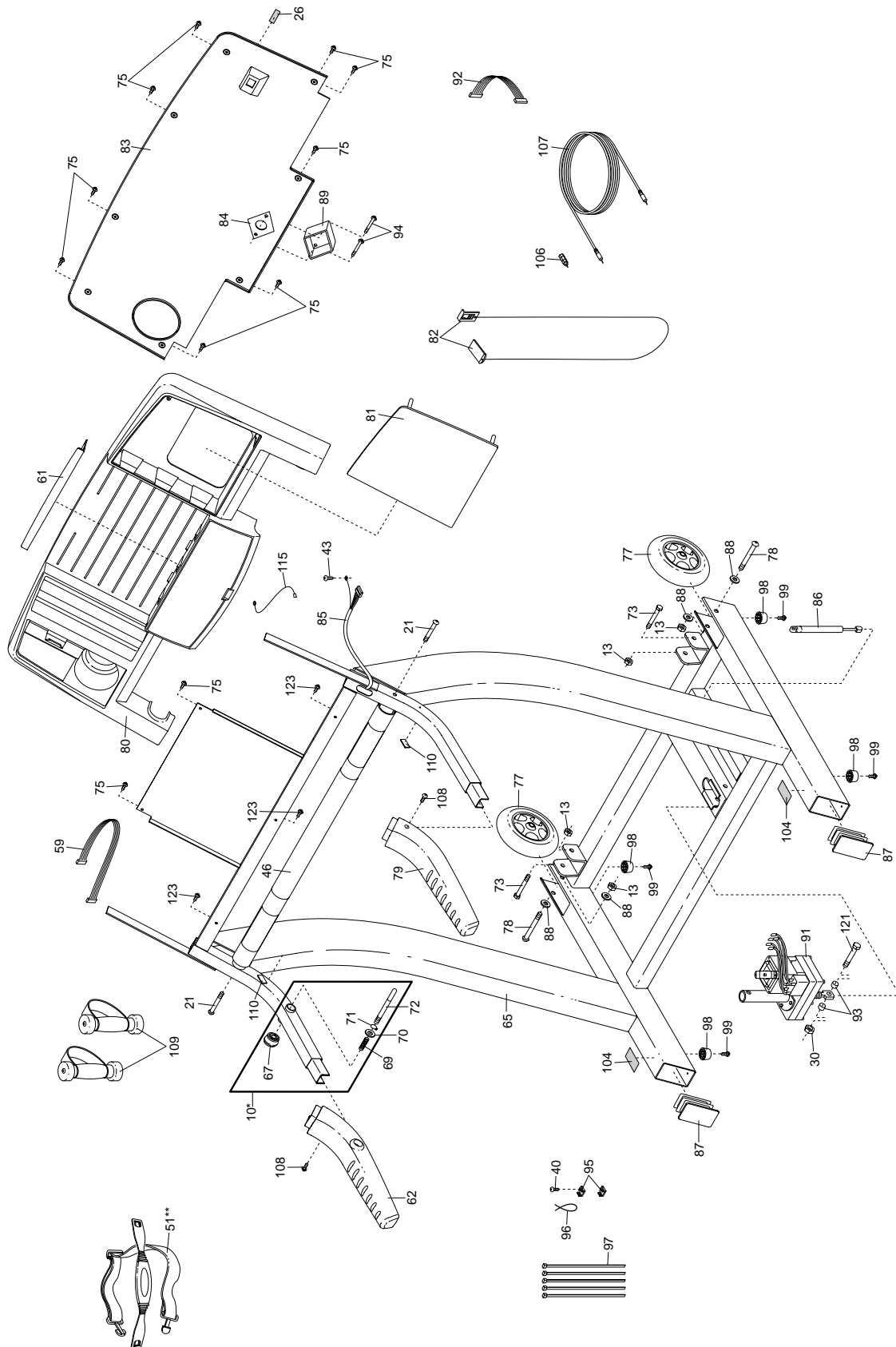

LIMITED WARRANTY

WHAT IS COVERED—The entire HealthRider® S700HRC treadmill (“Product”) is warranted to be free of all defects in material and workmanship.

WHO IS COVERED—The original purchaser or any person receiving the Product as a gift from the original purchaser.

HOW LONG IS IT COVERED—ICON Health & Fitness, Inc. (“ICON”), extends a lifetime warranty on the frame. The motor is covered for three years after the date of purchase. The belt and deck are covered for two years after the date of purchase. All mechanical components are covered for two years after the date of purchase. All electrical components are covered for two years after the date of purchase. Labor is covered for one year.

WHAT WE DO TO CORRECT COVERED DEFECTS—We will ship to you, without charge, any replacement part or component, providing the repairs are authorized by ICON first and are performed by an ICON trained and authorized service provider, or, at our option, we will replace the Product.

WHAT IS NOT COVERED—Any failures or damage caused by unauthorized service, misuse, accident, negligence, improper assembly or installation, alterations, modifications without our written authorization or by failure on your part to use, operate, and maintain as set out in your User’s Manual (“Manual”). This warranty does not extend to products used for commercial or rental purposes or to products used as store display modules.

WHAT YOU MUST DO—Always retain proof of purchase, such as your bill of sale; store, operate, and maintain the Product as specified in the Manual; notify our Customer Service Department of any defect within 10 days after discovery of the defect; as instructed, return any defected part for replacement or, if necessary, the entire product, for repair.

USER’S MANUAL—It is VERY IMPORTANT THAT YOU READ THE MANUAL before operating the Product. Remember to do the periodic maintenance requirements specified in the Manual to assure proper operation and your continued satisfaction.

HOW TO GET PARTS AND SERVICE—Simply call our Customer Service Department at 1-800-999-3756 and tell them your name and address and the serial number of your Product. They will tell you how to get a part replaced, or if necessary, arrange for service where your Product is located or advise you how to ship the Product for service. Before shipping, always obtain a Return Authorization Number (RA No.) from our Customer Service Department; securely pack your Product (save the original shipping carton if possible); put the RA No. on the outside of the carton and insure the product. Include a letter explaining the product or problem and a copy of your proof of purchase if you believe the service is covered by warranty.

ICON is not responsible or liable for indirect, special or consequential damages arising out of or in connection with the use or performance of the product or damages with respect to any economic loss, loss of property, loss of revenues or profits, loss of enjoyment or use, costs of removal, installation or other consequential damages of whatsoever nature. Some states do not allow the exclusion or limitation of incidental or consequential damages. Accordingly, the above limitation may not apply to you.

The warranty extended hereunder is in lieu of any and all other warranties and any implied warranties of merchantability or fitness for a particular purpose is limited in its scope and duration to the terms set forth herein. Some states do not allow limitations on how long an implied warranty lasts. Accordingly, the above limitation may not apply to you.

No one is authorized to change, modify or extend the terms of this limited warranty.

This warranty gives you specific legal rights and you may have other rights which vary from state to state.

ICON HEALTH & FITNESS, INC., 1500 S. 1000 W., LOGAN, UT 84321-9813