

TECHNICAL & SERVICE MANUAL



KHS0951 / CH0951
KHS1251 / CH1251
KHS1852 / CH1852

FILE NO.

Destination: U.S.A.

SPLIT SYSTEM AIR CONDITIONER

Indoor Model No.	Product Code No.
KHS0951	1 852 069 13
KHS1251	1 852 069 14
KHS1852-S	1 852 069 15

Outdoor Model No.	Product Code No.
CH0951	1 852 069 16
CH1251	1 852 069 17
CH1852	1 852 069 18

Indoor Unit

Outdoor Unit

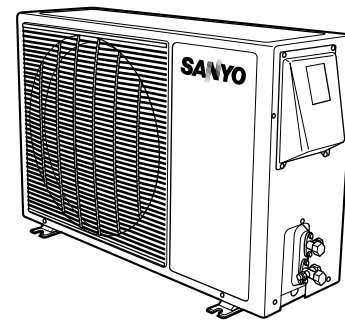
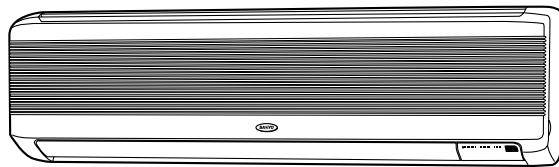

KHS0951
KHS1251

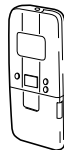

CH0951
CH0952

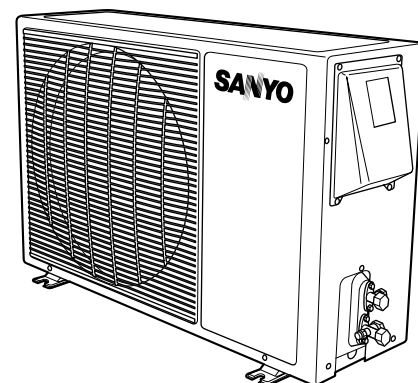
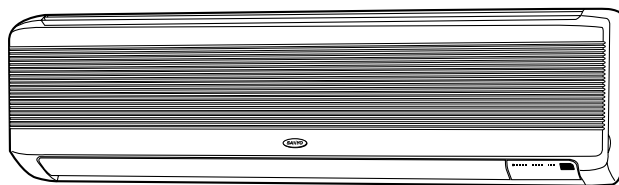

KHS1852

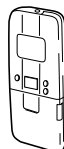

CH1852

IMPORTANT!

Please Read Before Starting

This air conditioning system meets strict safety and operating standards. As the installer or service person, it is an important part of your job to install or service the system so it operates safely and efficiently.

For safe installation and trouble-free operation, you must:

- Carefully read this instruction booklet before beginning.
- Follow each installation or repair step exactly as shown.
- Observe all local, state, and national electrical codes.
- Pay close attention to all warning and caution notices given in this manual.



WARNING

This symbol refers to a hazard or unsafe practice which can result in severe personal injury or death.



CAUTION

This symbol refers to a hazard or unsafe practice which can result in personal injury or product or property damage.

If Necessary, Get Help

These instructions are all you need for most installation sites and maintenance conditions. If you require help for a special problem, contact our sales/service outlet or your certified dealer for additional instructions.

In Case of Improper Installation

The manufacturer shall in no way be responsible for improper installation or maintenance service, including failure to follow the instructions in this document.

SPECIAL PRECAUTIONS

WARNING

When Wiring



ELECTRICAL SHOCK CAN CAUSE SEVERE PERSONAL INJURY OR DEATH. ONLY A QUALIFIED, EXPERIENCED ELECTRICIAN SHOULD ATTEMPT TO WIRE THIS SYSTEM.

- Do not supply power to the unit until all wiring and tubing are completed or reconnected and checked.
- Highly dangerous electrical voltages are used in this system. Carefully refer to the wiring diagram and these instructions when wiring. Improper connections and inadequate grounding can cause **accidental injury or death**.
- **Ground the unit** following local electrical codes.
- Connect all wiring tightly. Loose wiring may cause overheating at connection points and a possible fire hazard.

When Transporting

Be careful when picking up and moving the indoor and outdoor units. Get a partner to help, and bend your knees when lifting to reduce strain on your back. Sharp edges or thin aluminum fins on the air conditioner can cut your fingers.

When Installing...

...In a Ceiling or Wall

Make sure the ceiling/wall is strong enough to hold the unit's weight. It may be necessary to construct a strong wood or metal frame to provide added support.

...In a Room

Properly insulate any tubing run inside a room to prevent "sweating" that can cause dripping and water damage to walls and floors.

...In Moist or Uneven Locations

Use a raised concrete pad or concrete blocks to provide a solid, level foundation for the outdoor unit. This prevents water damage and abnormal vibration.

...In an Area with High Winds

Securely anchor the outdoor unit down with bolts and a metal frame. Provide a suitable air baffle.

...In a Snowy Area (for Heat Pump-type Systems)

Install the outdoor unit on a raised platform that is higher than drifting snow. Provide snow vents.

When Connecting Refrigerant Tubing

- Use the flare method for connecting tubing.
- Apply refrigerant lubricant to the matching surfaces of the flare and union tubes before connecting them, then tighten the nut with a torque wrench for a leak-free connection.
- Check carefully for leaks before starting the test run.

When Servicing

- Turn the power OFF at the main power box (mains) before opening the unit to check or repair electrical parts and wiring.
- Keep your fingers and clothing away from any moving parts.
- Clean up the site after you finish, remembering to check that no metal scraps or bits of wiring have been left inside the unit being serviced.

Others



CAUTION

- Ventilate any enclosed areas when installing or testing the refrigeration system. Escaped refrigerant gas, on contact with fire or heat, can produce dangerously toxic gas.
- Confirm upon completing installation that no refrigerant gas is leaking. If escaped gas comes in contact with a stove, gas water heater, electric room heater or other heat source, it can produce dangerously toxic gas.

Table of Contents

	Page
1. OPERATING RANGE	1
2. SPECIFICATIONS	
2-1. Unit Specifications	2
2-2. Major Component Specifications	5
2-3. Other Component Specifications	11
3. DIMENSIONAL DATA	
3-1. Unit	14
4. REFRIGERANT FLOW DIAGRAM	
4-1. Refrigerant Flow Diagram	18
5. PERFORMANCE DATA	
5-1. Performance Charts	19
5-2. Air Throw Distance Charts	22
5-3. Cooling Capacity	25
5-4. Heating Capacity	29
6. ELECTRICAL DATA	
6-1. Electrical Characteristics	30
6-2. Electric Wiring Diagrams	33
7. INSTALLATION INSTRUCTIONS	
7-1. Installation Site Selection	42
7-2. Remote Control Unit Installation Position	44
7-3. Address Switches	45
7-4. Recommended Wire Length and Diameter	46
8. FUNCTION	
8-1. Room Temperature Control	47
8-2. Dry Operation (Dehumidification)	49
8-3. Automatic Switching between Cooling and Heating	49
8-4. Freeze Prevention (Cooling)	50
8-5. Overload Prevention (Heating)	50
8-6. Cold draft Prevention (Heating)	51
8-7. Defrosting Operation (Heating)	52
8-8. Low Temperature Cutoff (Heating)	53
9. TROUBLESHOOTING	
9-1. Check before and after troubleshooting	54
9-2. Air conditioner does not operate	55
9-3. Some part of air conditioner does not operate	59
9-4. Air conditioner operates, but abnormalities are observed	61
9-5. If a sensor is defective	63

10. CHECKING ELECTRICAL COMPONENTS	
10-1. Measurement of Insulation Resistance	64
10-2. Checking Continuity of Fuse on PCB Ass'y	65
10-3. Checking Motor Capacitor	65
11. ARRANGEMENT OF ELECTRICAL COMPONENT	66

APPENDIX INSTRUCTION MANUAL

1. OPERATING RANGE

	Temperature	Indoor Air Intake Temp.	Outdoor Air Intake Temp.
Cooling	Maximum	95°F D.B. / 71°F W.B.	115°F D.B.
	Minimum	67°F D.B. / 57°F W.B.	67°F D.B.
Heating	Maximum	80°F D.B. / 67°F W.B.	75°F D.B. / 65°F W.B.
	Minimum	— D.B. / — W.B.	17°F D.B. / 15°F W.B.

2. SPECIFICATIONS

2-1. Unit Specifications

- (1) Indoor unit **KHS0951**
 Outdoor unit **CH0951**

			Cooling	Heating
Voltage Rating			115V 60Hz	
Performance			Cooling	Heating
Capacity	BTU/h		9,100	10,900
	kW		2.67	3.19
Air circulation (High)	ft ³ /min (m ³ /min)		270 (7.65)	
Moisture removal (High)	Pints/h		2.0	—
Electrical Rating			Cooling	Heating
Available voltage range	V		103 – 126	
Running amperes	A		8.5	8.4
Power input	W		890	890
Power factor	%		91	92
SEER (HSPF)	BTU/W		11.0	(6.8)
Compressor locked rotor amperes	A		49	
Heater element	kW		—	
Features				
Controls / Temperature control			Microprocessor / I.C. thermostat	
Control unit			Wireless remote control unit	
Timer			ON / OFF 12 hours, 1-hour OFF	
Fan speeds	Indoor / Outdoor		3 and Auto / 1 (Hi)	
Airflow direction (Indoor)	Horizontal		Manual	
	Vertical		Auto	
Air filter			Washable	
Compressor			Rotary (Hermetic)	
Refrigerant / Amount charged at shipment	lb. (kg)		2.65 (1.20)	
Refrigerant control			Capillary tube	
Operation sound	Indoor: Hi / Me / Lo	dB-A	38 / 34 / 32	
	Outdoor: Hi	dB-A	48	
Refrigerant tubing connections			Flare	
Max allowable tubing length at shipment	ft. (m)		25 (7.5)	
Refrigerant tubing diameter	Narrow tube	inch (mm)	1/4 (6.35)	
	Wide tube	inch (mm)	3/8 (9.52)	
Dimensions & Weight			Indoor Unit	Outdoor Unit
Unit dimensions	Height	inch (mm)	10-5/8 (270)	21-1/4 (540)
	Width	inch (mm)	31-11/16 (805)	31-1/2 (800)
	Depth	inch (mm)	6-31/32 (177)	11-13/32 (290)
Package dimensions	Height	inch (mm)	9-13/16 (249)	23-31/32 (609)
	Width	inch (mm)	33-21/32 (855)	38-5/8 (981)
	Depth	inch (mm)	13-5/16 (338)	16-3/16 (411)
Weight	Net	lb. (kg)	17.6 (8.0)	75.0 (34)
	Shipping	lb. (kg)	22.0 (10.0)	83.8 (38)
Shipping volume	cu.ft (m ³)		2.51 (0.071)	8.67 (0.246)

DATA SUBJECT TO CHANGE WITHOUT NOTICE.

Remarks: Rating conditions are

- Cooling: Indoor air temperature 80°F D.B. / 67°F W.B.
 Outdoor air temperature 95°F D.B. / 75°F W.B.
 Heating: Indoor air temperature 70°F D.B.
 Outdoor air temperature 47°F D.B. / 43°F W.B.

(2) Indoor unit **KHS1251**
 Outdoor unit **CH1251**

	Cooling	Heating
Voltage Rating	115V 60Hz	

Performance		Cooling	Heating
Capacity	BTU/h	11,700	12,500
	kW	3.43	3.66
Air circulation (High)	ft ³ /min (m ³ /min)	330 (9.35)	
Moisture removal (High)	Pints/h	3.4	—

Electrical Rating		Cooling	Heating
Available voltage range	V	103 – 126	
Running amperes	A	10.5	10.3
Power input	W	1,200	1,170
Power factor	%	99	99
SEER (HSPF)	BTU/W	10.2	(6.8)
Compressor locked rotor amperes	A	60	
Heater element	kW	—	

Features			
Controls / Temperature control		Microprocessor / I.C. thermostat	
Control unit		Wireless remote control unit	
Timer		ON / OFF 12 hours, 1-hour OFF	
Fan speeds	Indoor / Outdoor	3 and Auto / 1 (Hi)	
Airflow direction (Indoor)	Horizontal	Manual	
	Vertical	Auto	
Air filter		Washable	
Compressor		Rotary (Hermetic)	
Refrigerant / Amount charged at shipment	lb. (kg)	2.76 (1.25)	
Refrigerant control		Capillary tube	
Operation sound	Indoor: Hi / Me / Lo	dB-A	
	Outdoor: Hi	dB-A	
Refrigerant tubing connections		Flare	
Max allowable tubing length at shipment	ft. (m)	25 (7.5)	
Refrigerant tubing diameter	Narrow tube	inch (mm)	
	Wide tube	inch (mm)	

Dimensions & Weight			Indoor Unit	Outdoor Unit
Unit dimensions	Height	inch (mm)	10-5/8 (270)	21-1/4 (540)
	Width	inch (mm)	31-11/16 (805)	31-1/2 (800)
	Depth	inch (mm)	6-31/32 (177)	11-13/32 (290)
Package dimensions	Height	inch (mm)	9-13/16 (249)	23-31/32 (609)
	Width	inch (mm)	33-21/32 (855)	38-5/8 (981)
	Depth	inch (mm)	13-5/16 (338)	16-3/16 (411)
Weight	Net	lb. (kg)	17.6 (8.0)	83.8 (38)
	Shipping	lb. (kg)	22.0 (10.0)	92.6 (42)
Shipping volume		cu.ft (m ³)	2.51 (0.071)	8.67 (0.246)

DATA SUBJECT TO CHANGE WITHOUT NOTICE.

Remarks: Rating conditions are
 Cooling: Indoor air temperature 80°F D.B. / 67°F W.B.
 Outdoor air temperature 95°F D.B. / 75°F W.B.
 Heating: Indoor air temperature 70°F D.B.
 Outdoor air temperature 47°F D.B. / 43°F W.B.

(3) Indoor unit **KHS1852**
 Outdoor unit **CH1852**

	Cooling	Heating
Voltage Rating	230 / 208V 60Hz	

Performance		Cooling	Heating
Capacity	BTU/h	17,000 / 16,500	19,000 / 18,500
	kW	4.98 / 4.84	5.75 / 5.42
Air circulation (High)	ft ³ /min (m ³ /min)	390 (11.1)	
Moisture removal (High)	Pints/h	4.5 / 4.3	—

Electrical Rating		Cooling	Heating
Available voltage range	V	187 – 253	
Running amperes	A	7.6 / 8.1	7.1 / 7.5
Power input	W	1,700 / 1,660	1,610 / 1,540
Power factor	%	99	99
SEER (HSPF)	BTU/W	10.5	(6.8)
Compressor locked rotor amperes	A	43	
Heater element	kW	—	

Features			
Controls / Temperature control		Microprocessor / I.C. thermostat	
Control unit		Wireless remote control unit	
Timer		ON / OFF 12 hours, 1-hour OFF	
Fan speeds	Indoor / Outdoor	3 and Auto / 1 (Hi)	
Airflow direction (Indoor)	Horizontal	Manual	
	Vertical	Auto	
Air filter		Washable	
Compressor		Rotary (Hermetic)	
Refrigerant / Amount charged at shipment	lb. (kg)	3.97 (1.80)	
Refrigerant control		Capillary tube	
Operation sound	Indoor: Hi / Me / Lo dB-A	41 / 38 / 36	
	Outdoor: Hi dB-A	52	
Refrigerant tubing connections		Flare	
Max allowable tubing length at shipment	ft. (m)	25 (7.5)	
Refrigerant tubing diameter	Narrow tube inch (mm)	1/4 (6.35)	
	Wide tube inch (mm)	5/8 (15.88)	

Dimensions & Weight			Indoor Unit	Outdoor Unit
Unit dimensions	Height	inch (mm)	11-7/32 (285)	24-19/32 (625)
	Width	inch (mm)	39-3/16 (995)	34-21/32 (880)
	Depth	inch (mm)	7-23/32 (196)	12-19/32 (320)
Package dimensions	Height	inch (mm)	10-7/8 (276)	27-15/16 (710)
	Width	inch (mm)	42-1/8 (1,070)	40-9/16 (1,030)
	Depth	inch (mm)	14-9/32 (363)	16-3/16 (411)
Weight	Net	lb. (kg)	26.5 (12.0)	108 (49)
	Shipping	lb. (kg)	33 (15.0)	117 (53)
Shipping volume		cu.ft (m ³)	3.78 (0.107)	10.6 (0.301)

DATA SUBJECT TO CHANGE WITHOUT NOTICE.

Remarks: Rating conditions are
 Cooling: Indoor air temperature 80°F D.B. / 67°F W.B.
 Outdoor air temperature 95°F D.B. / 75°F W.B.
 Heating: Indoor air temperature 70°F D.B.
 Outdoor air temperature 47°F D.B. / 43°F W.B.

2-2. Major Component Specifications

2-2-1. Indoor Unit

(1) Indoor unit **KHS0951**

Control PCB		
Part No.		POW-KHS095A, POW-KHS095B
Controls		Microprocessor
Control circuit fuse		AC 115V – 3A
Remote Control Unit		RCS-1HS2U
Fan & Fan Motor		
Type		Cross-flow
Q'ty ... Dia. and length	inch (mm)	1 ... \varnothing 3-3/4 / L24-9/32 (\varnothing 95 / L617)
Fan motor model ... Q'ty		KFV4-21H1PA ... 1P
Nominal output	W	20
Coil resistance (ambient temp. 68°F (20°C))	Ω	BLU – BRN: 100.9 BLU – PNK: 127.5
Run capacitor	μ F	3.5
	VAC	180
Flap Motor		
Type		Stepping motor
Model		MP24GA1
Rating		DC12V
Coil resistance (ambient temp. 77°F (25°C))	Ω	WHT – BLU (respectively 4 wires): 380 \pm 7%
Heat Exchanger Coil		
Coil		Aluminum plate fin / Copper tube
Rows		2
Fin pitch	inch (mm)	1/16 (1.4)
Face area	ft ² (m ²)	1.40 (0.130)

DATA SUBJECT TO CHANGE WITHOUT NOTICE.

(2) Indoor unit **KHS1251**

Control PCB		
Part No.		POW-KHS125A / POW-KHS095B
Controls		Microprocessor
Control circuit fuse		AC 115V – 3A

Remote Control Unit	
	RCS-1HS2U

Fan & Fan Motor		
Type		Cross-flow
Q'ty ... Dia. and length	inch (mm)	1 ... \varnothing 3-3/4 / L24-9/32 (\varnothing 95 / L617)
Fan motor model ... Q'ty		KFV4-21H1PA ... 1P
Nominal output	W	20
Coil resistance (ambient temp. 68°F (20°C))	Ω	BLU – BRN: 100.9 BLU – PNK: 127.5
Run capacitor	μ F	3.5
	VAC	180

Flap Motor		
Type		Stepping motor
Model		MP24GA1
Rating		DC12V
Coil resistance (ambient temp. 77°F (25°C))	Ω	WHT – BLU (respectively 4 wires): 380 \pm 7%

Heat Exchanger Coil		
Coil		Aluminum plate fin / Copper tube
Rows		2
Fin pitch	inch (mm)	1/16 (1.4)
Face area	ft ² (m ²)	1.40 (0.130)

DATA SUBJECT TO CHANGE WITHOUT NOTICE.

(3) Indoor unit KHS1852

Control PCB		
Part No.		POW-KHS1852
Controls		Microprocessor
Control circuit fuse		AC 208 / 230V – 3A

Remote Control Unit		RCS-1HS2U
----------------------------	--	-----------

Fan & Fan Motor		
Type		Cross-flow
Q'ty ... Dia. and length	inch (mm)	1 ... \varnothing 3-15/32 / L29-3/8 (\varnothing 88 / L746)
Fan motor model ... Q'ty		UF4-31D6P-S ... 1P
Nominal output	W	30
Coil resistance (ambient temp. 68°F (20°C))	Ω	WHT – BRN: 204.2 WHT – PNK: 158.3
Run capacitor	μ F	2.0
	VAC	440

Flap Motor		
Type		Stepping motor
Model		MP24GA2
Rating		DC12V
Coil resistance (ambient temp. 77°F (25°C))	Ω	Each terminals (1–2, 1–3, 1–4, 1–5) : 400 \pm 7%

Heat Exchanger Coil		
Coil		Aluminum plate fin / Copper tube
Rows		2
Fin pitch	inch (mm)	1/16 (1.3)
Face area	ft ² (m ²)	1.68 (0.156)

DATA SUBJECT TO CHANGE WITHOUT NOTICE.

2-2-2. Outdoor Unit

(1) Outdoor unit CH0951

Control PCB		
Part No.		POW-CH095
Controls		—
Control circuit fuse		—

Compressor		
Type		Rotary (Hermetic)
Compressor model		C-1R75H2R
Nominal output	W	750
Compressor oil ... Amount	cc	SUNISO 4GSD-T ... 350
Coil resistance (ambient temp. 68°F (20°C))	Ω	C – R: 0.841 C – S: 2.831
Safety devices	Type	External (OLR)
	Overload relay	MRA99111-9200
Run capacitor	μF	40
	VAC	400
Crank case heater		115V, 20W

Fan & Fan Motor		
Type		Propeller
Q'ty ... Dia. and length	inch. (mm)	1 ... 16-17/32 (ø 420)
Fan motor model ... Q'ty		UE6-21BA1PA ... 1
No. of poles ... rpm (115V, High)		6 ... 630
Nominal output	W	20
Coil resistance (ambient temp. 68°F (20°C))	Ω	BLU – BRN: 45.3 BLU – PNK: 50.5
Run capacitor	μF	8
	VAC	220

Heat Exchanger Coil		
Coil		Aluminum plate fin / Copper tube
Rows		2
Fin pitch	inch (mm)	1/16 (1.4)
Face area	ft ² (m ²)	3.37 (0.313)

External Finish	Acrylic baked-on enamel finish
------------------------	--------------------------------

DATA SUBJECT TO CHANGE WITHOUT NOTICE.

(2) Outdoor unit CH1251

Control PCB		
Part No.		POW-CH095
Controls		—
Control circuit fuse		—

Compressor		
Type		Rotary (Hermetic)
Compressor model		C-R95H2E
Nominal output	W	950
Compressor oil ... Amount	cc	SUNISO 4GSD-T ... 570
Coil resistance (ambient temp. 68°F (20°C))	Ω	C – R: 0.576 C – S: 3.070
Safety devices	Type	External (OLR)
	Overload relay	MRA98693-9200
Run capacitor	μF	40
	VAC	400
Crank case heater		115V, 20W

Fan & Fan Motor		
Type		Propeller
Q'ty ... Dia. and length	inch. (mm)	1 ... 16-17/32 (ø 420)
Fan motor model ... Q'ty		UE6-21BA1PA ... 1
No. of poles ... rpm (115V, High)		6 ... 630
Nominal output	W	20
Coil resistance (ambient temp. 68°F (20°C))	Ω	BLU – BRN: 45.3 BLU – PNK: 50.5
Run capacitor	μF	8
	VAC	220

Heat Exchanger Coil		
Coil		Aluminum plate fin / Copper tube
Rows		2
Fin pitch	inch (mm)	1/16 (1.4)
Face area	ft ² (m ²)	3.37 (0.313)

External Finish	Acrylic baked-on enamel finish
------------------------	--------------------------------

DATA SUBJECT TO CHANGE WITHOUT NOTICE.

(3) Outdoor unit CH1852

Control PCB		
Part No.		POW-CH095
Controls		—
Control circuit fuse		—

Compressor		
Type		Rotary (Hermetic)
Compressor model		C-R132H6D
Nominal output	W	1,300
Compressor oil ... Amount	cc	SUNISO 4GSD-T ... 500
Coil resistance (ambient temp. 68°F (20°C))	Ω	C – R: 1.442 C – S: 2.430
Safety devices	Type	External (OLR)
	Overload relay	MRA99117-9200
Run capacitor	μF	35
	VAC	400
Crank case heater		230V, 20W

Fan & Fan Motor		
Type		Propeller
Q'ty ... Dia. and length	inch. (mm)	1 ... 16-17/32 (ø 420)
Fan motor model ... Q'ty		KFG6-51E6PA ... 1
No. of poles ... rpm (230V, High)		6 ... 830
Nominal output	W	50
Coil resistance (ambient temp. 68°F (20°C))	Ω	WHT – BRN: 102 PNK – WHT: 199
Run capacitor	μF	2
	VAC	440

Heat Exchanger Coil		
Coil		Aluminum plate fin / Copper tube
Rows		2
Fin pitch	inch (mm)	1/16 (1.6)
Face area	ft ² (m ²)	5.13 (0.477)

External Finish	Acrylic baked-on enamel finish
------------------------	--------------------------------

DATA SUBJECT TO CHANGE WITHOUT NOTICE.

2-3. Other Component Specifications

2-3-1. Indoor Unit

(1) Indoor unit KHS0951

Transformer		ATR-T4
Rating	Primary	AC 115V, 60Hz
	Secondary	19V, 0.5A
Thermistor (Coil sensor)		DTN-TKS131B
Resistance	kΩ	32°F (0°C) 15 ± 2%
Thermistor (Room sensor in lamp Ass'y)		DTN-TKS134B
Resistance	kΩ	77°F (25°C) 5 ± 3%

DATA SUBJECT TO CHANGE WITHOUT NOTICE.

(2) Indoor unit KHS1251

Transformer		ATR-T4
Rating	Primary	AC 115V, 60Hz
	Secondary	19V, 0.5A
Thermistor (Coil sensor)		DTN-TKS131B
Resistance	kΩ	32°F (0°C) 15 ± 2%
Thermistor (Room sensor in lamp Ass'y)		DTN-TKS134B
Resistance	kΩ	77°F (25°C) 5 ± 3%

DATA SUBJECT TO CHANGE WITHOUT NOTICE.

(3) Indoor unit KHS1852

Transformer		ATR-T5
Rating	Primary	AC 230V, 60Hz
	Secondary	19V, 0.5A
Thermistor (Coil sensor)		DTN-TKS131B
Resistance	kΩ	32°F (0°C) 15 ± 2%
Thermistor (Room sensor)		DTN-TKS142B
Resistance	kΩ	77°F (25°C) 5 ± 3%

DATA SUBJECT TO CHANGE WITHOUT NOTICE.

2-3-2. Outdoor Unit

(1) Outdoor Unit CH0951

PTC Thermistor	PS2A E20-470
Resistance Ω at 77°F (25°C)	47 ± 25%
Power Relay (PR)	DFU24D1-F
Coil rating	DC 24V
Coil resistance Ω at 68°F (20°C)	650 ± 10%
Contact rating	AC 250V, 20A
Thermostat (Defrost thermo. 23D)	TRS02-12MSR
Operating temp. °F (°C)	ON 54 ± 4°F (12 ± 2°C)
	Diff. 14 deg (8 deg). below
Thermostat (Low temp. cutoff 23A)	TRS02-M13MSR436
Operating temp. °F (°C)	OFF (OPEN) : 5°F (-15°C)
	ON (CLOSE) : 17°F (-8.3°C)
4-way Valve (Solenoid coil)	LB69001 (Coil), VH79102 (Valve)
Coil rating	AC 120V, 6W

DATA SUBJECT TO CHANGE WITHOUT NOTICE

(2) Outdoor Unit CH1251

PTC Thermistor	PS2A E20-470
Resistance Ω at 77°F (25°C)	47 ± 25%
Power Relay (PR)	DFU24D1-F
Coil rating	DC 24V
Coil resistance Ω at 68°F (20°C)	650 ± 10%
Contact rating	AC 250V, 20A
Thermostat (Defrost thermo. 23D)	TRS02-12MSR
Operating temp. °F (°C)	ON 54 ± 4°F (12 ± 2°C)
	Diff. 14 deg (8 deg). below
Thermostat (Low temp. cutoff 23A)	TRS02-M13MSR436
Operating temp. °F (°C)	OFF (OPEN) : 5°F (-15°C)
	ON (CLOSE) : 17°F (-8.3°C)
4-way Valve (Solenoid coil)	LB69001 (Coil), V26-9201 (Valve)
Coil rating	AC 120V, 6W

DATA SUBJECT TO CHANGE WITHOUT NOTICE

(3) Outdoor Unit CH1852

Power Relay (PR)		DFU24D1-F
Coil rating		DC 24V
Coil resistance	Ω at 68°F (20°C)	650 ± 10%
Contact rating		AC 250V, 20A
Thermostat (Defrost thermo. 23D)		TRS02-12MSR
Operating temp.	°F (°C)	ON 54 ± 4°F (12 ± 2°C)
		Diff. 14 deg (8 deg). below
Thermostat (Low temp. cutoff 23A)		TRS02-M13MSR436
Operating temp.	°F (°C)	OFF (OPEN) : 5°F (-15°C)
		ON (CLOSE) : 17°F (-8.3°C)
4-way Valve (Solenoid coil)		LB69005 (Coil), V26-9201 (Valve)
Coil rating		AC 208-230V, 6W

DATA SUBJECT TO CHANGE WITHOUT NOTICE

3. DIMENSIONAL DATA

3-1. Unit

3-1-1. Indoor Unit

(1) Indoor unit **KHS0951 / KHS1251**

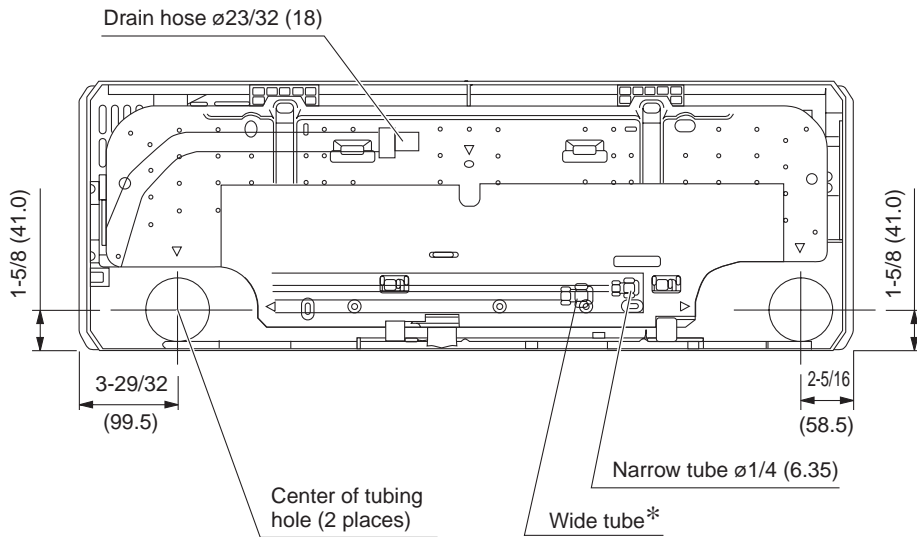
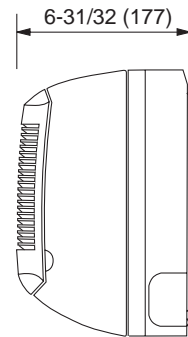
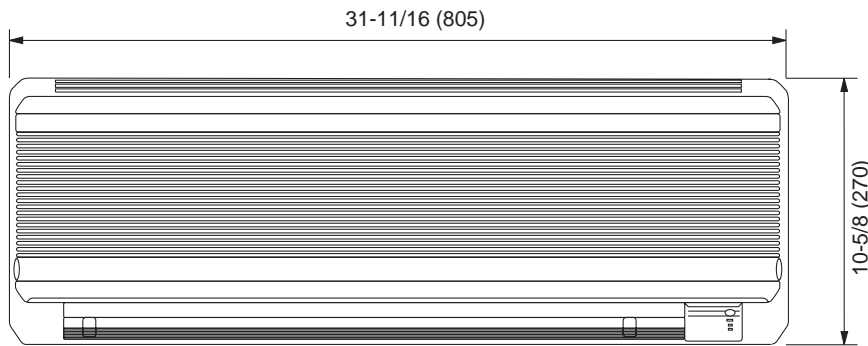
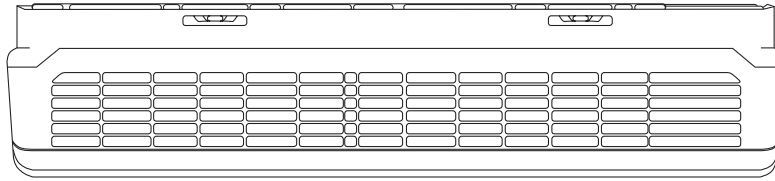

Remote control unit

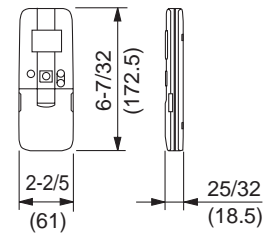

*

KHS0951	ø3/8 (9.52)
KHS1251	ø1/2 (12.7)

Unit: inch (mm)

(2) Indoor unit **KHS1852**

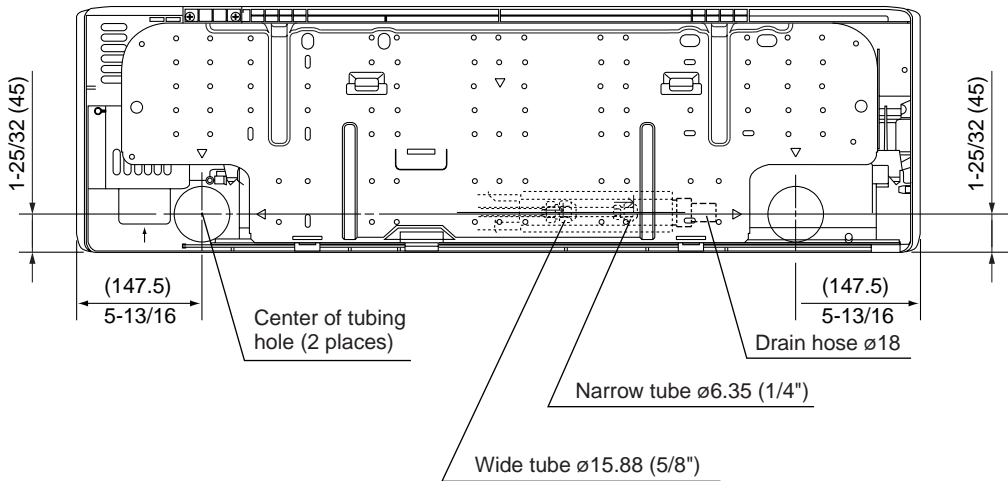
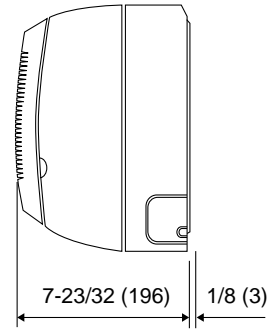
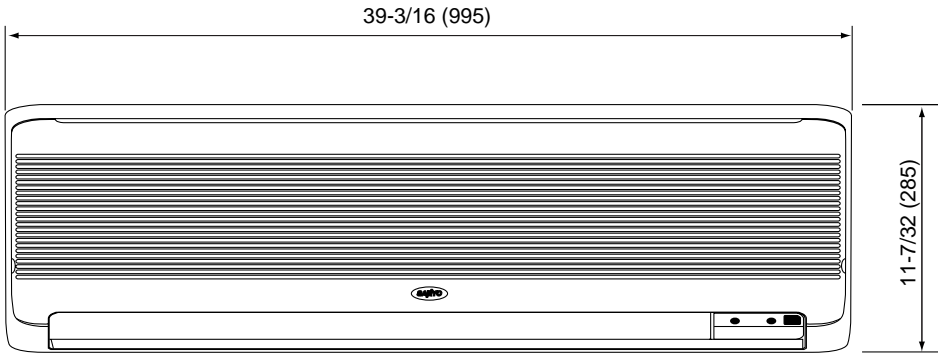
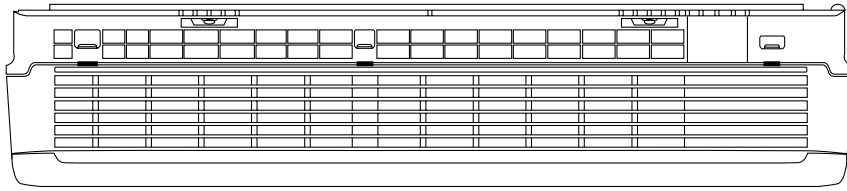

Remote control unit

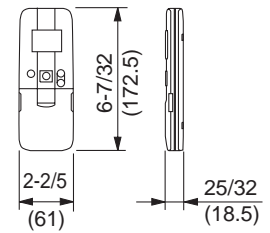

Unit : inch (mm)

3-1-2. Outdoor Unit

(1) Outdoor unit CH0951 / CH1251

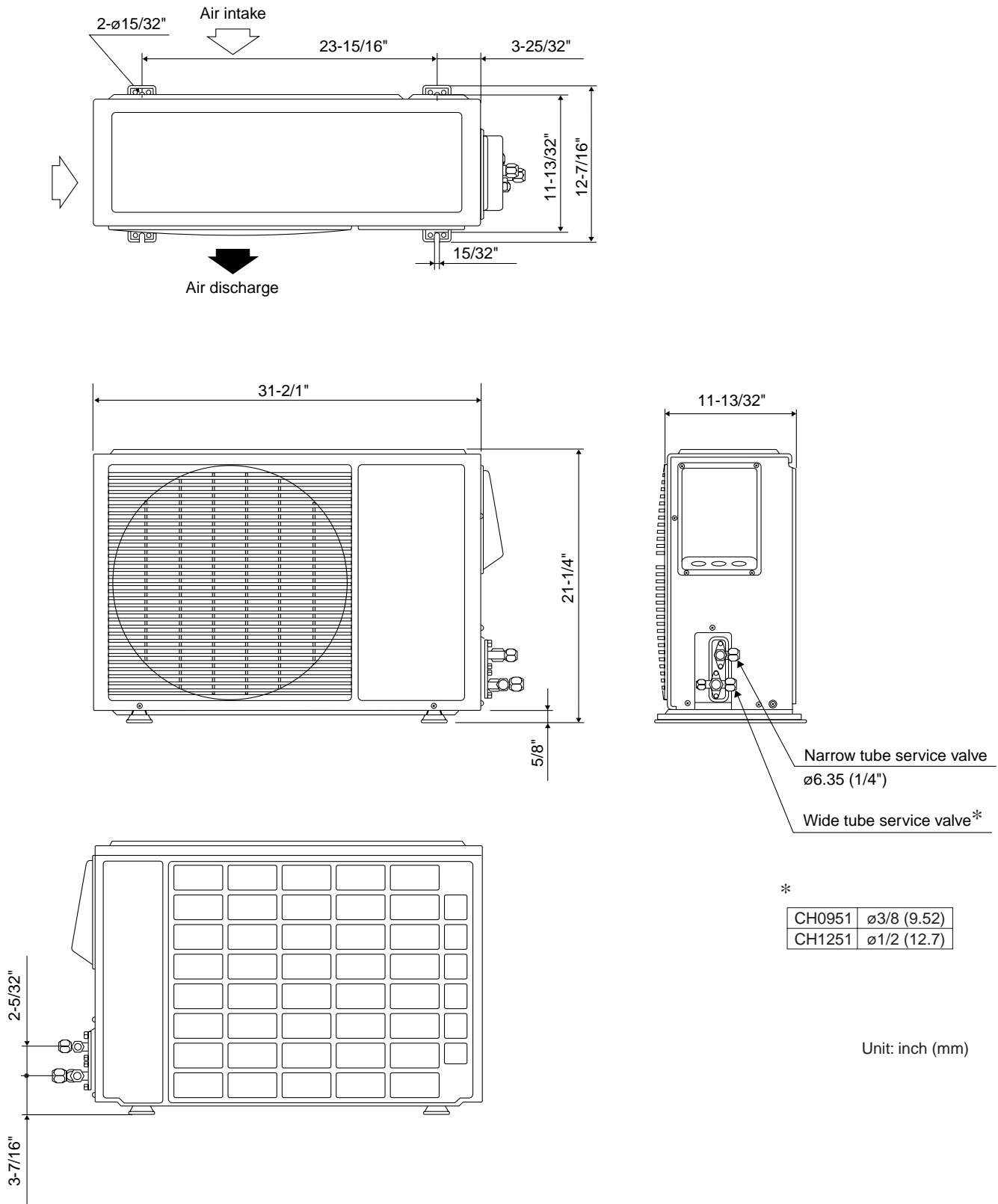

(2) Outdoor unit CH1852

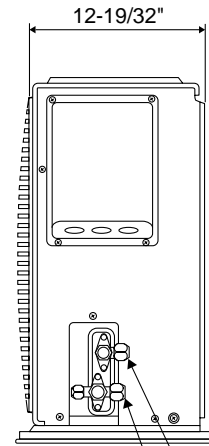
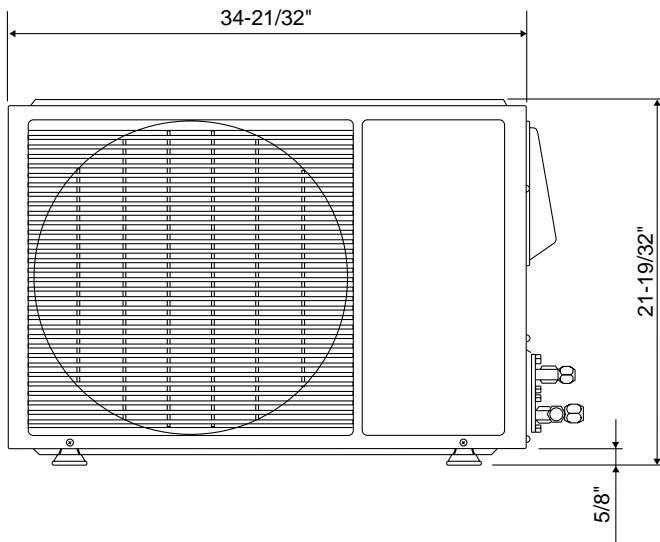
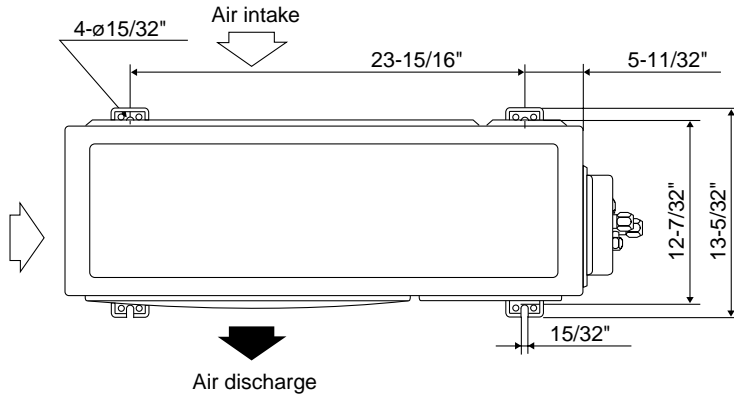

Narrow tube service valve
ø6.35 (1/4")

Wide tube service valve
ø15.88 (5/8")

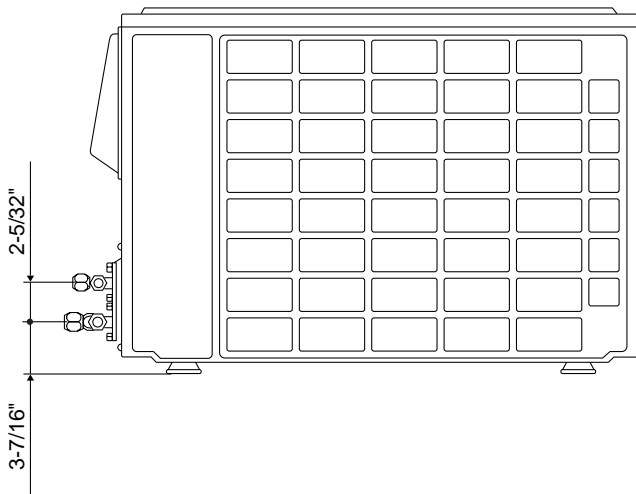

Unit: inch (mm)

4. REFRIGERANT FLOW DIAGRAM

4-1. Refrigerant Flow Diagram

Indoor unit **KHS0951 / KHS1251**
 Outdoor unit **CH0951 / CH1251**

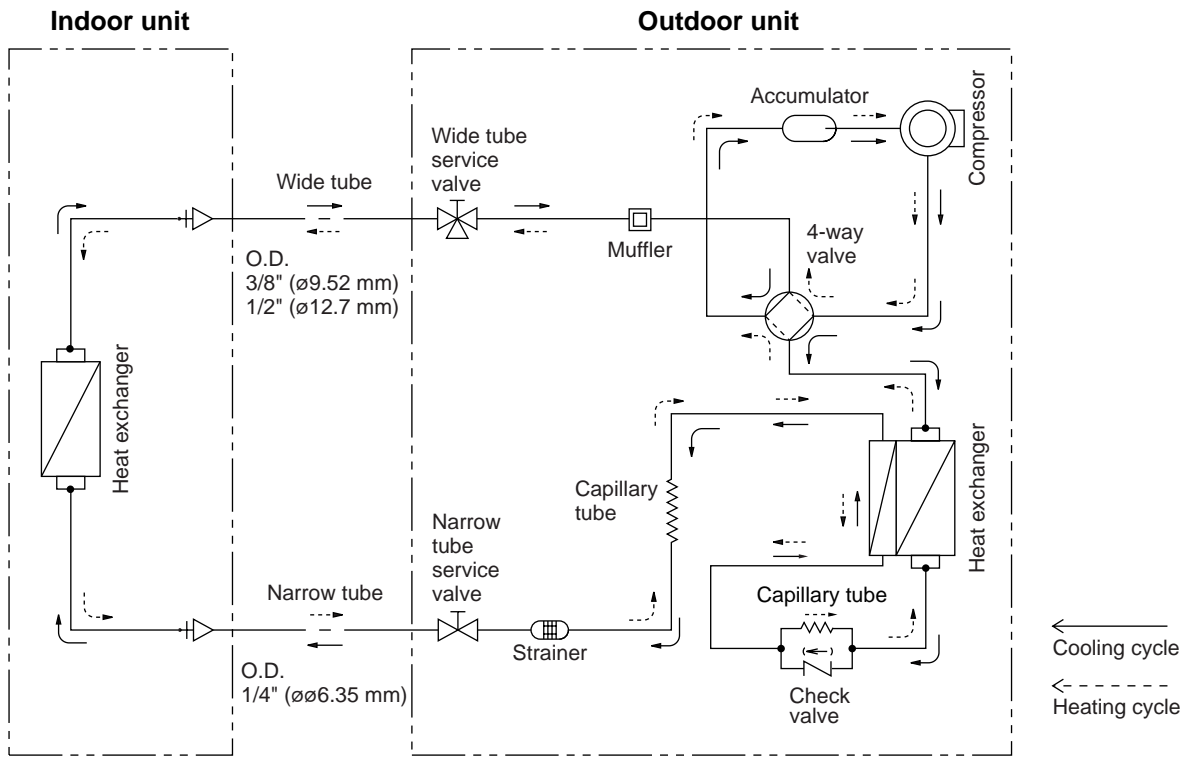

Indoor unit **KHS1852**
 Outdoor unit **CH1852**

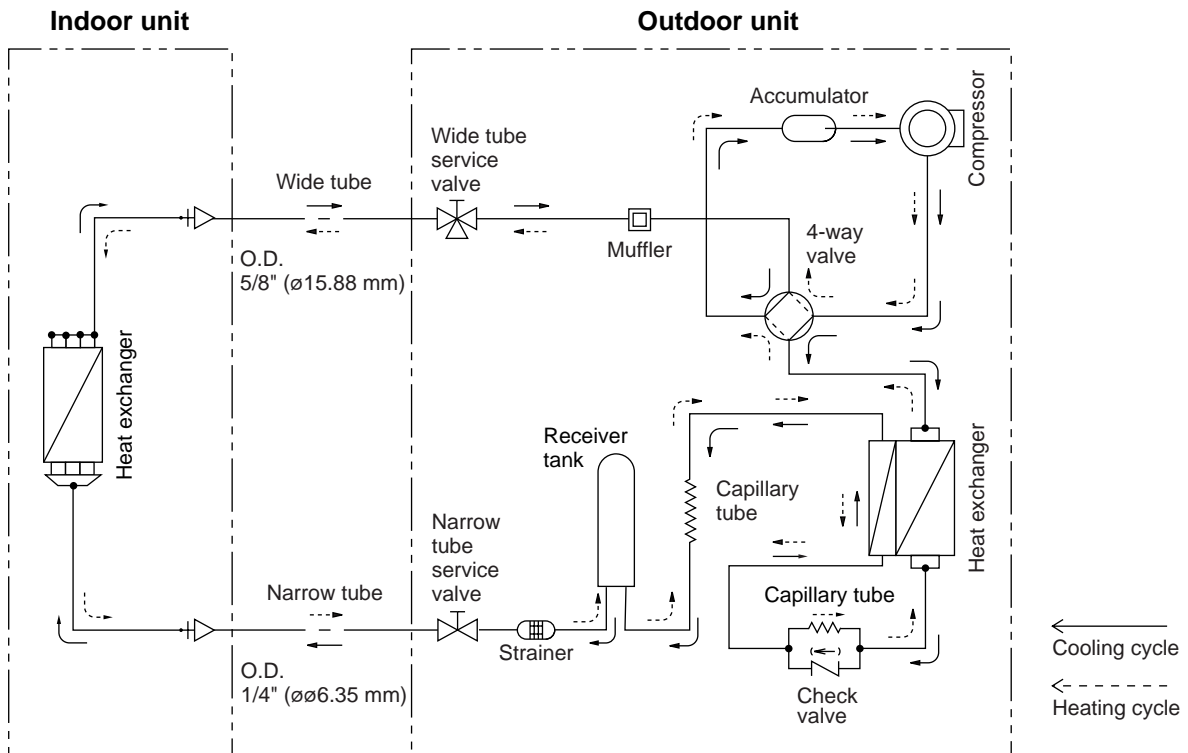

5. PERFORMANCE DATA

5-1. Performance Charts

Indoor Unit **KHS0951**
 Outdoor Unit **CH0951**

■ Cooling Characteristics

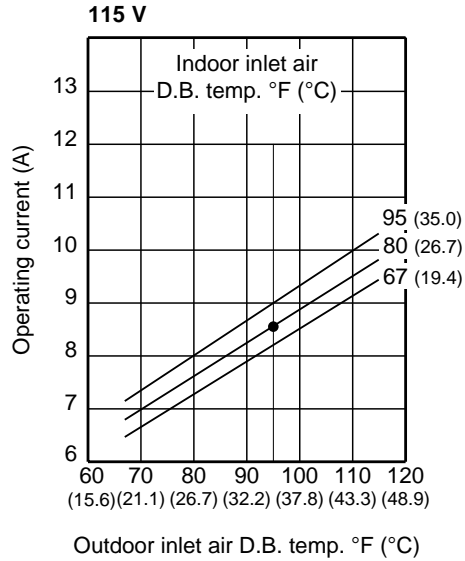

■ Heating Characteristics

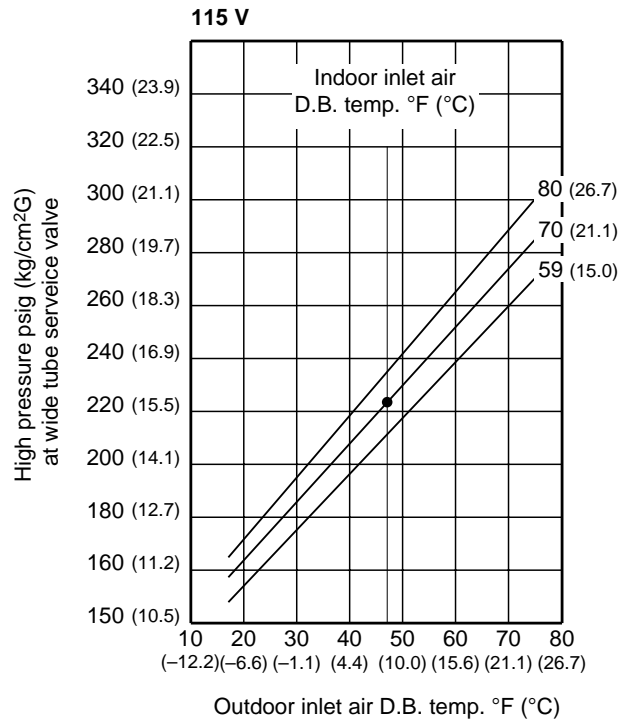
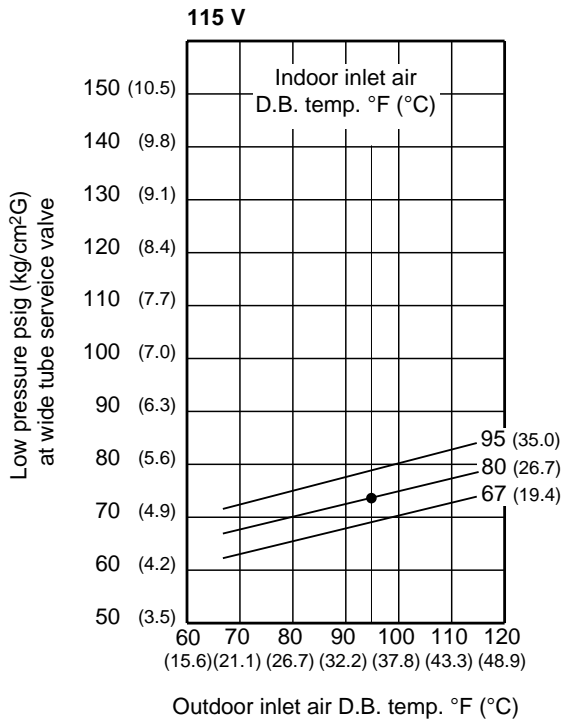
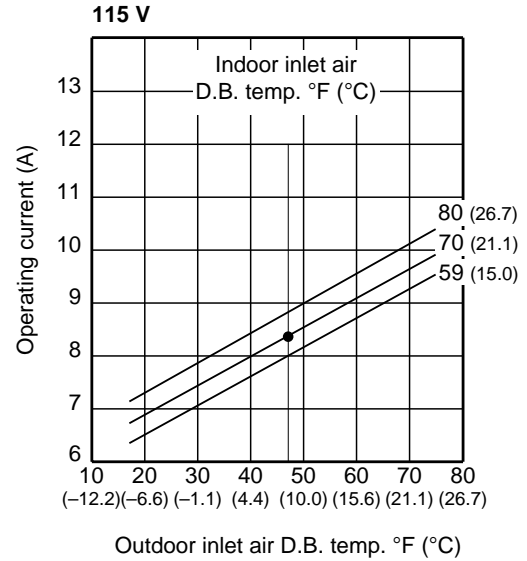

NOTE

Overload prevention operates to protect the air conditioner when the outdoor ambient temperature reaches an abnormally high level while in heating mode. (Refer to 8-5. Overload prevention)

- Points of Rating condition
 Black dots in above charts indicate the following rating conditions.

Cooling: Indoor air temperature 80°F D.B. / 67°F W.B.
 Outdoor air temperature 95°F D.B.

Heating: Indoor air temperature 70°F D.B.
 Outdoor air temperature 47°F D.B. / 43°F W.B.

Indoor Unit **KHS1251**
 Outdoor Unit **CH1251**

■ **Cooling Characteristics**

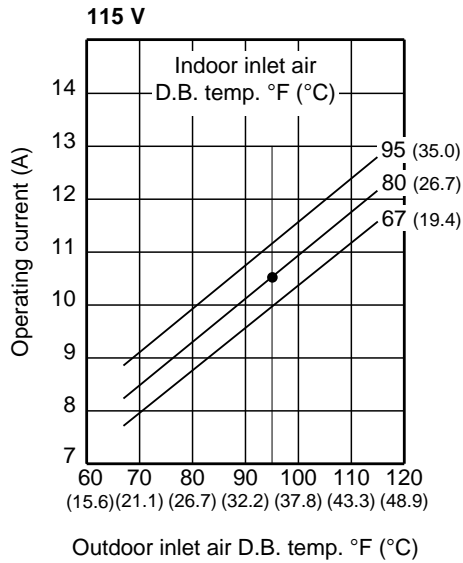

■ **Heating Characteristics**

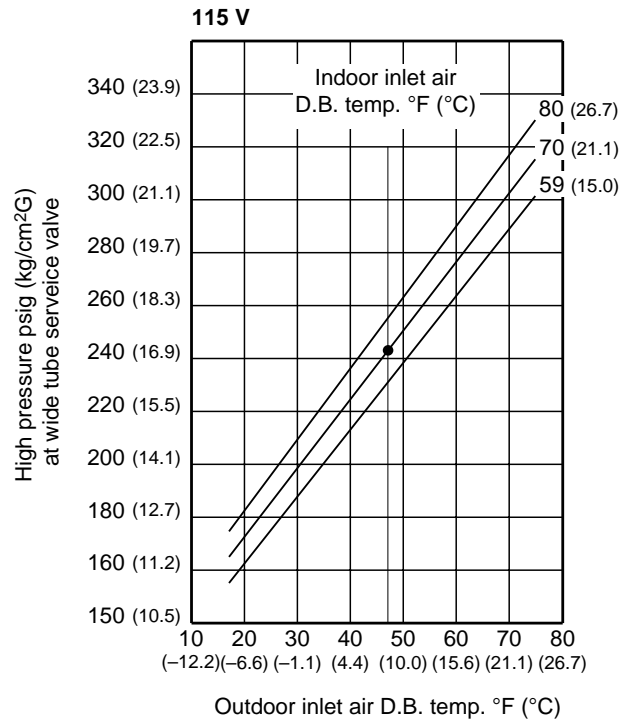
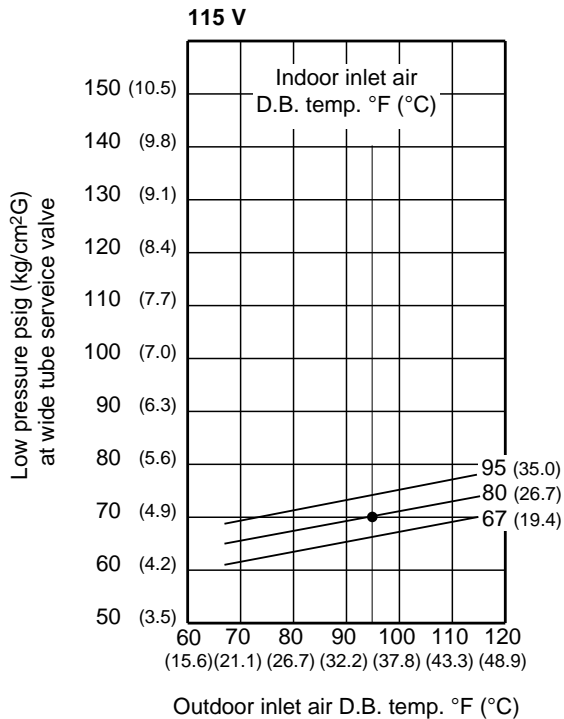
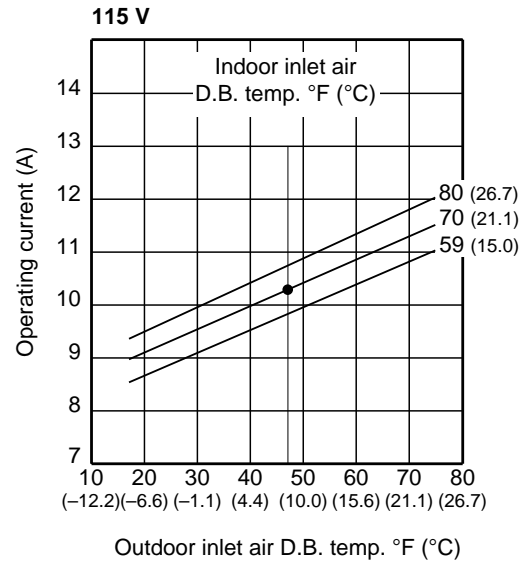

NOTE

Overload prevention operates to protect the air conditioner when the outdoor ambient temperature reaches an abnormally high level while in heating mode. (Refer to 8-5. Overload prevention)

● Points of Rating condition
 Black dots in above charts indicate the following rating conditions.

Cooling: Indoor air temperature 80°F D.B. / 67°F W.B.
 Outdoor air temperature 95°F D.B.

Heating: Indoor air temperature 70°F D.B.
 Outdoor air temperature 47°F D.B. / 43°F W.B.

Indoor Unit **KHS1852**
 Outdoor Unit **CH1852**

■ **Cooling Characteristics**

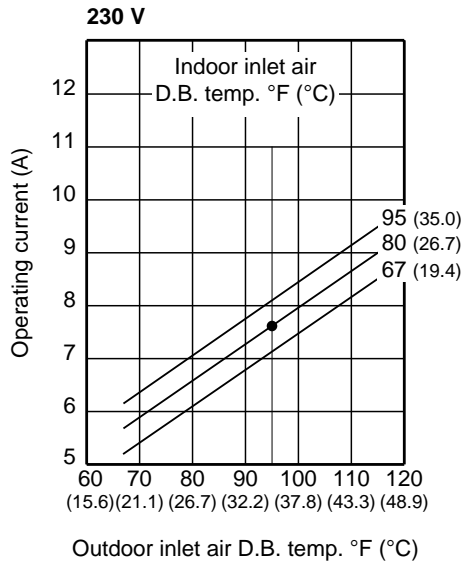

■ **Heating Characteristics**

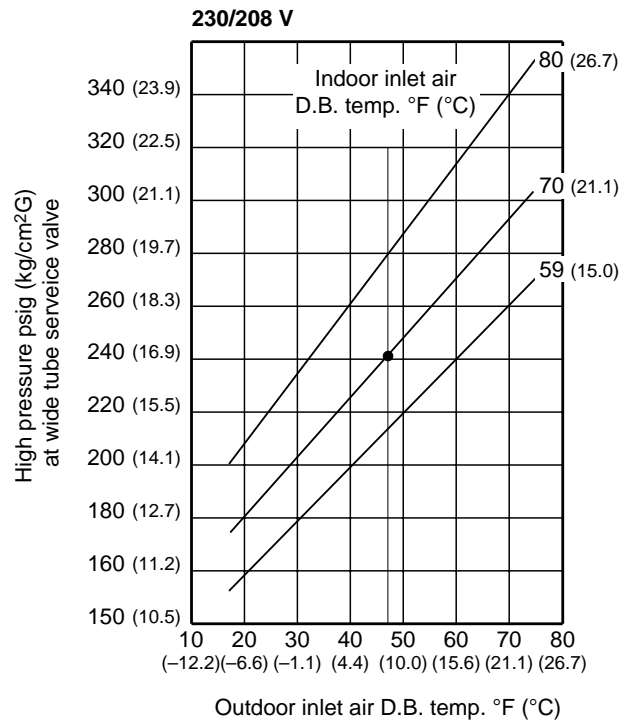
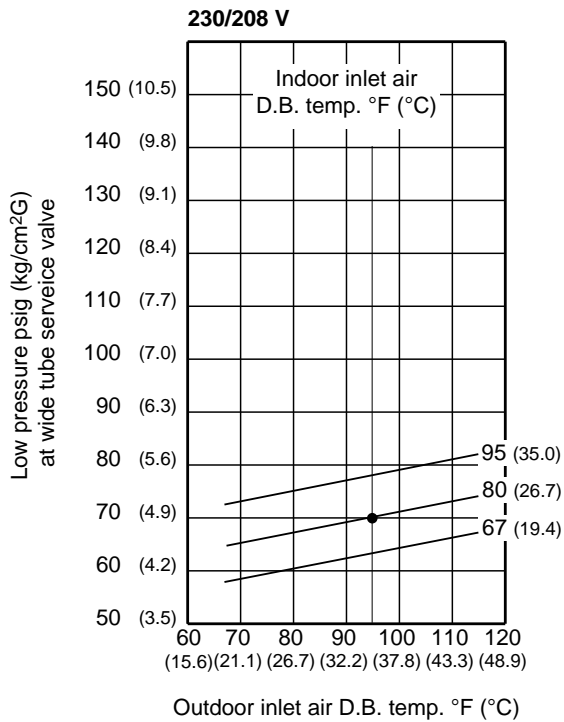
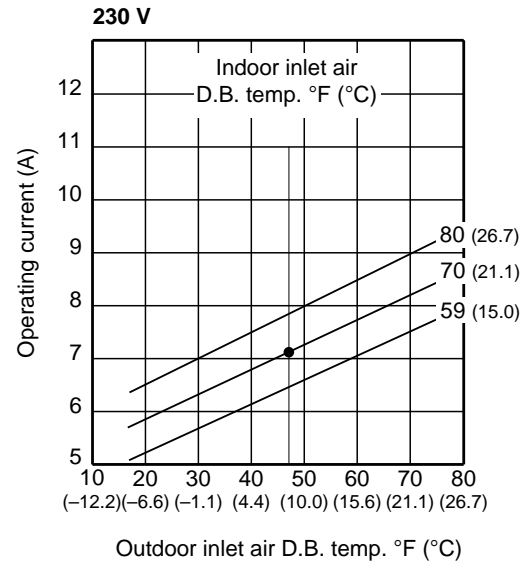

NOTE

Overload prevention operates to protect the air conditioner when the outdoor ambient temperature reaches an abnormally high level while in heating mode. (Refer to 8-5. Overload prevention)

- Points of Rating condition
 Black dots in above charts indicate the following rating conditions.

Cooling: Indoor air temperature 80°F D.B. / 67°F W.B.
 Outdoor air temperature 95°F D.B.

Heating: Indoor air temperature 70°F D.B.
 Outdoor air temperature 47°F D.B. / 43°F W.B.

5-2. Air Throw Distance Chart

(1) Indoor Unit KHS0951

Cooling

Room air temp. : 80°F (26.7°C)

Fan speed : High

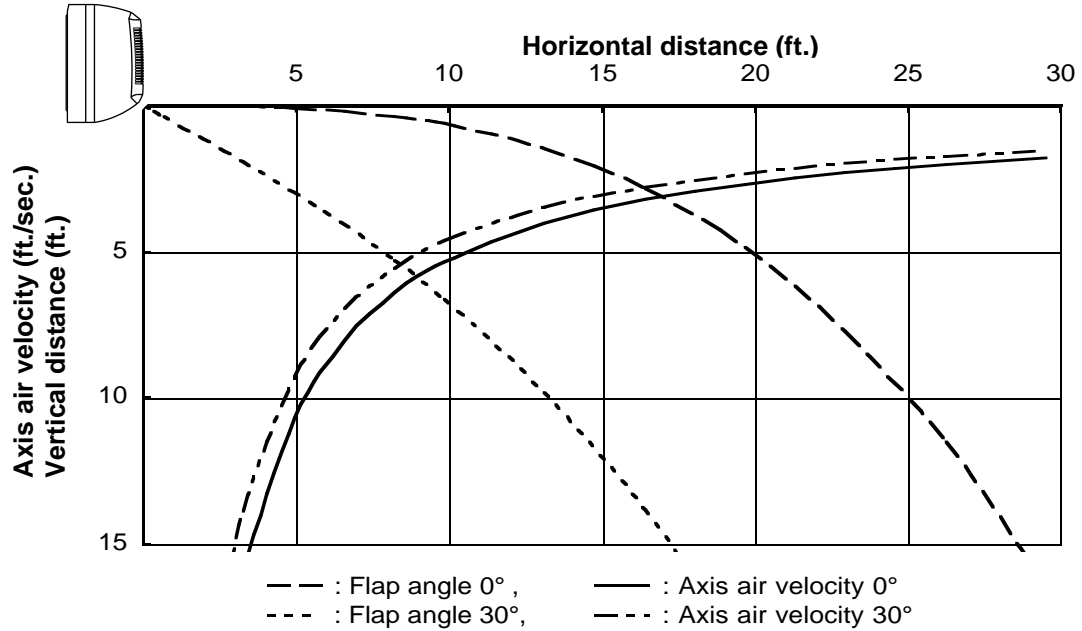

Heating

Room air temp. : 70°F (21.1°C)

Fan speed : High

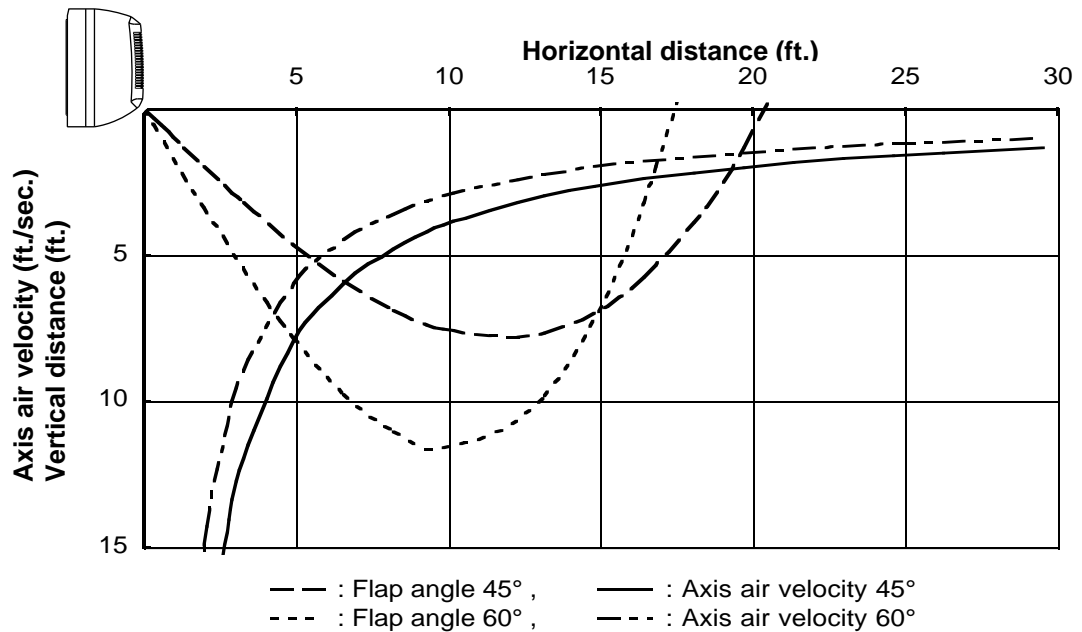

(2) Indoor Unit KHS1251

Cooling

Room air temp. : 80°F (26.7°C)

Fan speed : High

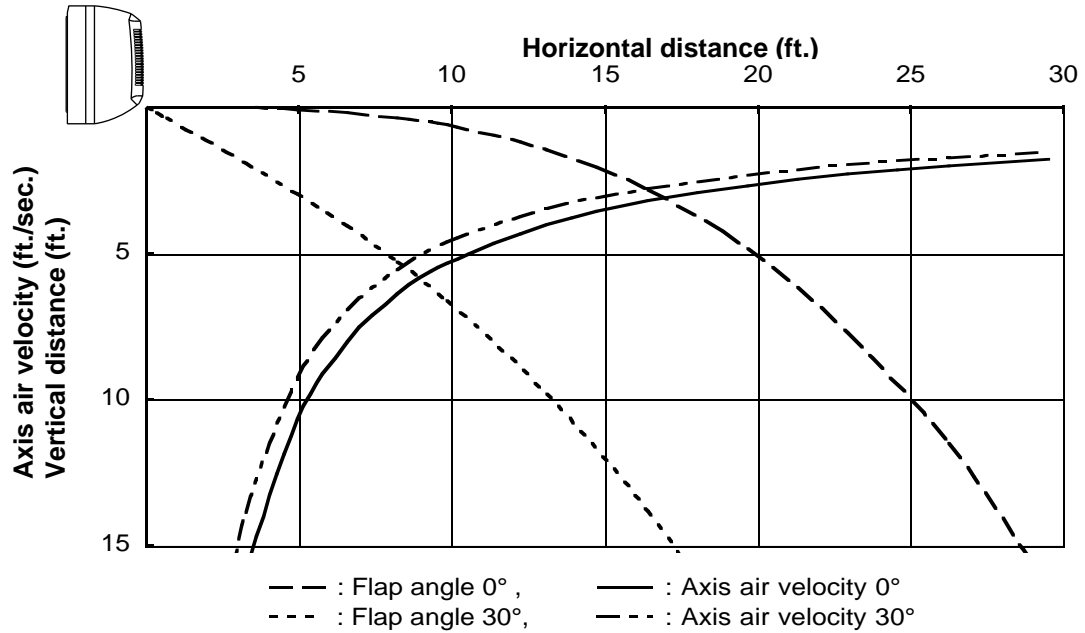

Heating

Room air temp. : 70°F (21.1°C)

Fan speed : High

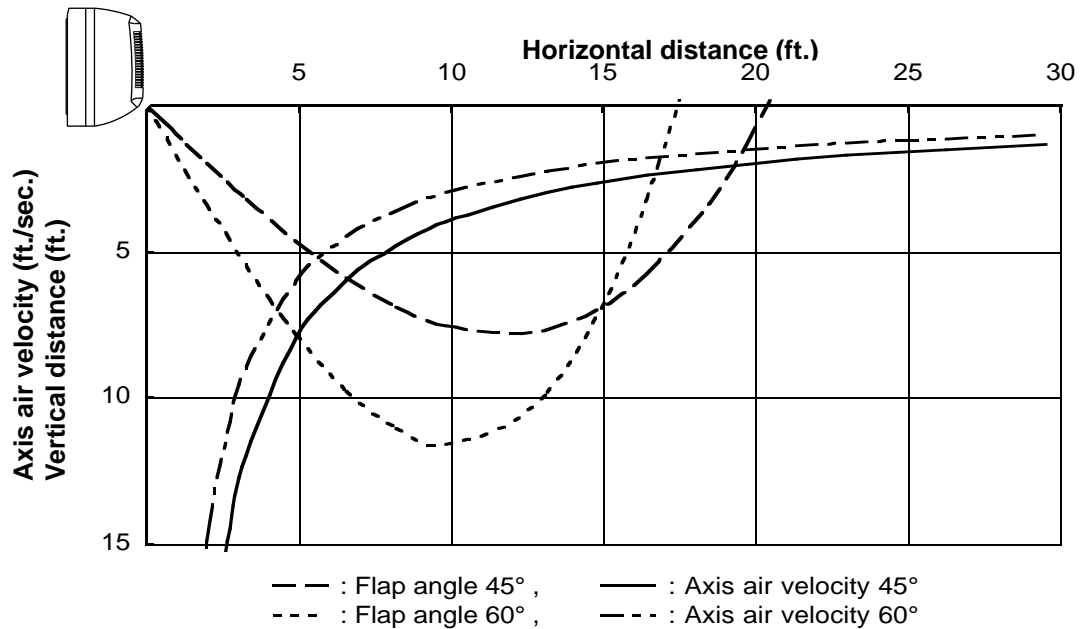

(3) Indoor Unit KH1852

Cooling

Room air temp. : 80°F (26.7°C)
 Fan speed : High

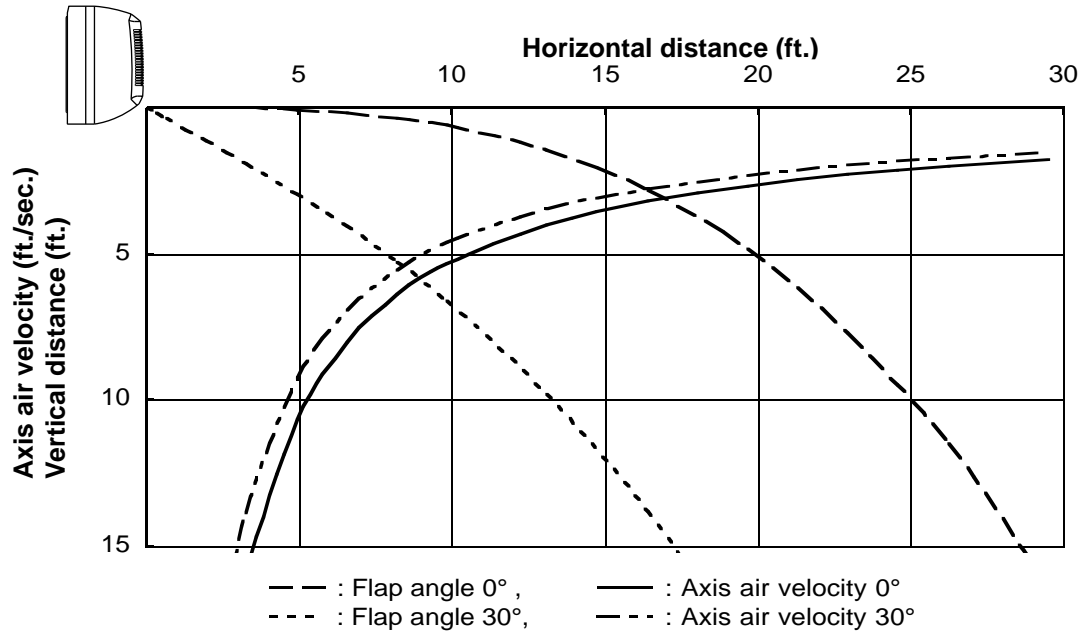

Heating

Room air temp. : 70°F (21.1°C)
 Fan speed : High

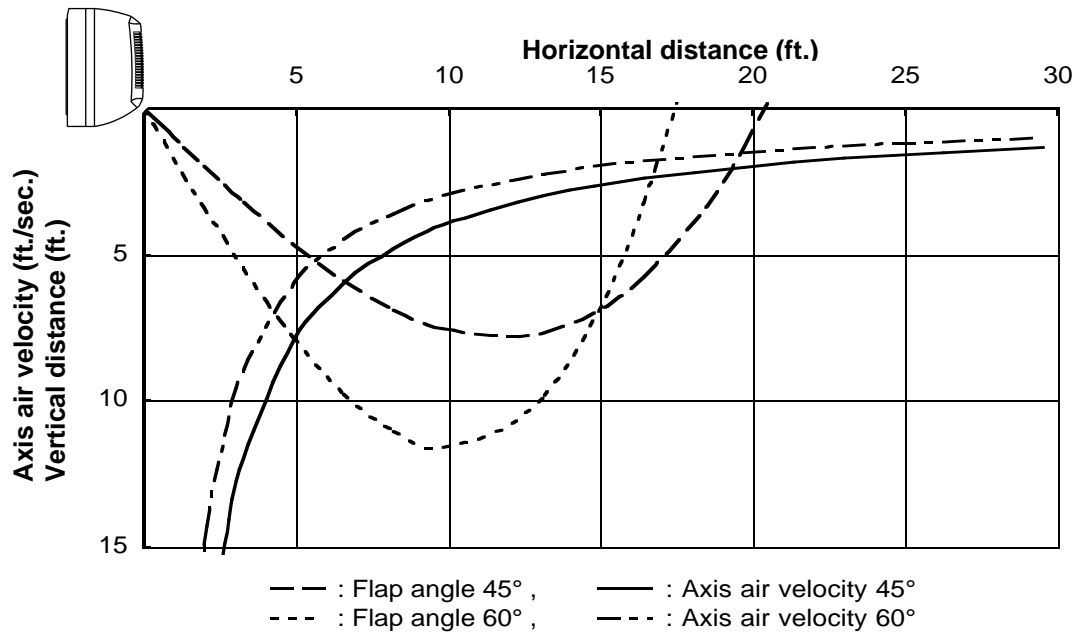

5-3. Cooling Capacity

Indoor Unit **KHS0951**
 Outdoor Unit **CH0951**

115V Single phase 60 Hz

RATING CAPACITY :		9,100 BTU/h		AIR FLOW RATE:		270 CFM	
EVAPORATOR		CONDENSER					
ENT.TEMP.°F (°C)		AMBIENT TEMP °F (°C)					
WB	DB		75 (23.9)	85 (29.4)	95 (35.0)	105 (40.6)	115 (46.1)
59 (15.0)		TC	9,220	8,770	8,260	7,690	7,050
		CI	0.64	0.7	0.76	0.82	0.9
	72(22.2)	SHC	6,720	6,490	6,240	5,960	5,650
	76(24.4)	SHC	7,580	7,350	7,090	6,820	6,510
	80(26.7)	SHC	8,470	8,240	7,990	7,690	7,050
	88(28.9)	SHC	9,220	8,770	8,260	7,690	7,050
63 (17.2)		TC	9,560	9,140	8,680	8,160	7,600
		CI	0.65	0.71	0.77	0.84	0.92
	72(22.2)	SHC	5,670	5,470	5,260	5,020	4,780
	76(24.4)	SHC	6,520	6,330	6,120	5,880	5,630
	80(26.7)	SHC	7,420	7,220	7,010	6,780	6,530
	88(28.9)	SHC	9,130	8,930	8,680	8,160	7,600
67 (19.4)		TC	9,930	9,540	# 9,100	8,620	8,090
		CI	0.65	0.71	0.78	0.85	0.94
	72(22.2)	SHC	4,610	4,450	4,260	4,060	3,850
	76(24.4)	SHC	5,470	5,300	5,120	4,920	4,700
	80(26.7)	SHC	6,360	6,200	6,010	5,810	5,600
	88(28.9)	SHC	8,080	7,910	7,720	7,520	7,310
71 (21.7)		TC	10,460	10,090	9,700	9,270	8,800
		CI	0.66	0.72	0.79	0.87	0.96
	72(22.2)	SHC	3,560	3,420	3,270	3,100	2,930
	76(24.4)	SHC	4,420	4,270	4,120	3,960	3,790
	80(26.7)	SHC	5,310	5,170	5,020	4,860	4,680
	88(28.9)	SHC	7,030	6,880	6,730	6,570	6,390
75 (23.9)		TC	10,670	10,320	9,960	9,540	9,090
		CI	0.67	0.73	0.8	0.89	0.99
	76(24.4)	SHC	3,280	3,160	3,040	2,890	2,740
	80(26.7)	SHC	4,180	4,060	3,930	3,790	3,640
	88(28.9)	SHC	5,890	5,770	5,640	5,500	5,350

TC :Total Cooling Capacity (BTU/h)
 SHC:Sensible Heat Capacity (BTU/h)
 CI :Compressor Input (kW)

Rating conditions are

:Outdoor Ambient Temp.95°FDB
 :Indoor Unit Entering Air Temp.80°FDB/67°FWB

Indoor Unit **KHS1251**
 Outdoor Unit **CH1251**

115 V Single phase 60 Hz

RATING CAPACITY :		11,700 BTU/h		AIR FLOW RATE:		330 CFM	
EVAPORATOR		CONDENSER					
ENT.TEMP.°F (°C)		AMBIENT TEMP °F (°C)					
WB	DB		75 (23.9)	85 (29.4)	95 (35.0)	105 (40.6)	115 (46.1)
59 (15.0)		TC	11,850	11,280	10,620	9,890	9,070
		CI	0.89	0.98	1.06	1.15	1.26
	72(22.2)	SHC	8,440	8,140	7,800	7,430	7,030
	76(24.4)	SHC	9,450	9,150	8,810	8,440	8,040
	80(26.7)	SHC	10,500	10,200	9,860	9,490	9,070
	84(28.9)	SHC	11,510	11,210	10,620	9,890	9,070
	88(28.9)	SHC	11,850	11,280	10,620	9,890	9,070
63 (17.2)		TC	12,300	11,750	11,160	10,490	9,770
		CI	0.9	0.99	1.08	1.17	1.29
	72(22.2)	SHC	7,180	6,920	6,640	6,320	6,000
	76(24.4)	SHC	8,190	7,920	7,640	7,330	7,000
	80(26.7)	SHC	9,240	8,980	8,700	8,380	8,060
	84(28.9)	SHC	10,250	9,980	9,700	9,390	9,060
	88(28.9)	SHC	11,260	10,990	10,710	10,400	9,770
67 (19.4)		TC	12,760	12,260	# 11,700	11,080	10,400
		CI	0.91	1	1.09	1.19	1.32
	72(22.2)	SHC	5,910	5,690	5,450	5,180	4,900
	76(24.4)	SHC	6,920	6,700	6,450	6,190	5,900
	80(26.7)	SHC	7,970	7,750	7,500	7,240	6,960
	84(28.9)	SHC	8,980	8,760	8,510	8,250	7,960
	88(28.9)	SHC	9,980	9,760	9,520	9,250	8,970
71 (21.7)		TC	13,440	12,980	12,470	11,920	11,310
		CI	0.92	1.01	1.11	1.22	1.35
	72(22.2)	SHC	4,660	4,470	4,270	4,050	3,820
	76(24.4)	SHC	5,660	5,480	5,280	5,060	4,830
	80(26.7)	SHC	6,720	6,530	6,330	6,110	5,880
	84(28.9)	SHC	7,720	7,540	7,330	7,120	6,890
	88(28.9)	SHC	8,730	8,540	8,340	8,130	7,890
75 (23.9)		TC	13,710	13,270	12,800	12,260	11,690
		CI	0.94	1.02	1.12	1.25	1.38
	76(24.4)	SHC	4,290	4,130	3,960	3,770	3,580
	80(26.7)	SHC	5,340	5,180	5,020	4,830	4,630
	84(28.9)	SHC	6,350	6,190	6,020	5,830	5,640
	88(28.9)	SHC	7,360	7,200	7,030	6,840	6,640

TC :Total Cooling Capacity (BTU/h)
 SHC:Sensible Heat Capacity (BTU/h)
 CI :Compressor Input (kW)

Rating conditions are

:Outdoor Ambient Temp.95°FDB
 :Indoor Unit Entering Air Temp.80°FDB/67°FWB

Indoor Unit **KHS1852**
 Outdoor Unit **CH1852**

208 V Single phase 60 Hz

RATING CAPACITY :		17,000 BTU/h		AIR FLOW RATE:		390 CFM	
EVAPORATOR		CONDENSER					
ENT.TEMP. °F (°C)		AMBIENT TEMP °F (°C)					
WB	DB		75 (23.9)	85 (29.4)	95 (35.0)	105 (40.6)	115 (46.1)
59 (15.0)		TC	17,220	16,390	15,440	14,370	13,180
		CI	1.26	1.38	1.5	1.62	1.79
	72(22.2)	SHC	11,770	11,290	10,750	10,170	9,540
	76(24.4)	SHC	12,960	12,480	11,950	11,360	10,730
	80(26.7)	SHC	14,210	13,730	13,200	12,610	11,980
	84(28.9)	SHC	15,410	14,920	14,390	13,800	13,170
63 (17.2)		TC	17,870	17,070	16,220	15,250	14,200
		CI	1.28	1.4	1.52	1.66	1.82
	72(22.2)	SHC	10,190	9,770	9,320	8,830	8,320
	76(24.4)	SHC	11,380	10,960	10,520	10,030	9,510
	80(26.7)	SHC	12,630	12,210	11,770	11,270	10,760
	84(28.9)	SHC	13,830	13,400	12,960	12,470	11,950
67 (19.4)		TC	18,550	17,820	# 17,000	16,100	15,110
		CI	1.29	1.41	1.54	1.68	1.86
	72(22.2)	SHC	8,600	8,240	7,850	7,430	6,990
	76(24.4)	SHC	9,790	9,440	9,050	8,630	8,180
	80(26.7)	SHC	11,040	10,680	10,290	9,880	9,430
	84(28.9)	SHC	12,230	11,880	11,490	11,070	10,620
71 (21.7)		TC	19,530	18,850	18,120	17,320	16,440
		CI	1.3	1.42	1.56	1.72	1.9
	72(22.2)	SHC	7,040	6,740	6,420	6,080	5,710
	76(24.4)	SHC	8,240	7,930	7,620	7,280	6,910
	80(26.7)	SHC	9,480	9,180	8,860	8,520	8,160
	84(28.9)	SHC	10,680	10,380	10,060	9,720	9,350
75 (23.9)		TC	19,920	19,280	18,600	17,820	16,980
		CI	1.32	1.45	1.59	1.76	1.95
	76(24.4)	SHC	6,480	6,220	5,960	5,660	5,340
	80(26.7)	SHC	7,720	7,470	7,200	6,900	6,590
	84(28.9)	SHC	8,920	8,660	8,400	8,100	7,780
	88(28.9)	SHC	10,110	9,860	9,590	9,290	8,980

TC :Total Cooling Capacity (BTU/h)
 SHC:Sensible Heat Capacity (BTU/h)
 CI :Compressor Input (kW)

Rating conditions are

:Outdoor Ambient Temp.95°FDB
 :Indoor Unit Entering Air Temp.80°FDB/67°FWB

Indoor Unit **KHS1852**
 Outdoor Unit **CH1852**

230 V Single phase 60 Hz

RATING CAPACITY :		17,000 BTU/h		AIR FLOW RATE:		390 CFM	
EVAPORATOR		CONDENSER					
ENT.TEMP. °F (°C)		AMBIENT TEMP °F (°C)					
WB	DB		75 (23.9)	85 (29.4)	95 (35.0)	105 (40.6)	115 (46.1)
59 (15.0)		TC	17,220	16,390	15,440	14,370	13,180
		CI	1.26	1.38	1.5	1.62	1.79
	72(22.2)	SHC	11,770	11,290	10,750	10,170	9,540
	76(24.4)	SHC	12,960	12,480	11,950	11,360	10,730
	80(26.7)	SHC	14,210	13,730	13,200	12,610	11,980
	84(28.9)	SHC	15,410	14,920	14,390	13,800	13,170
	88(28.9)	SHC	16,600	16,120	15,440	14,370	13,180
63 (17.2)		TC	17,870	17,070	16,220	15,250	14,200
		CI	1.28	1.4	1.52	1.66	1.82
	72(22.2)	SHC	10,190	9,770	9,320	8,830	8,320
	76(24.4)	SHC	11,380	10,960	10,520	10,030	9,510
	80(26.7)	SHC	12,630	12,210	11,770	11,270	10,760
	84(28.9)	SHC	13,830	13,400	12,960	12,470	11,950
	88(28.9)	SHC	15,020	14,590	14,150	13,660	13,150
67 (19.4)		TC	18,550	17,820	# 17,000	16,100	15,110
		CI	1.29	1.41	1.54	1.68	1.86
	72(22.2)	SHC	8,600	8,240	7,850	7,430	6,990
	76(24.4)	SHC	9,790	9,440	9,050	8,630	8,180
	80(26.7)	SHC	11,040	10,680	10,290	9,880	9,430
	84(28.9)	SHC	12,230	11,880	11,490	11,070	10,620
	88(28.9)	SHC	13,430	13,070	12,680	12,260	11,810
71 (21.7)		TC	19,530	18,850	18,120	17,320	16,440
		CI	1.3	1.42	1.56	1.72	1.9
	72(22.2)	SHC	7,040	6,740	6,420	6,080	5,710
	76(24.4)	SHC	8,240	7,930	7,620	7,280	6,910
	80(26.7)	SHC	9,480	9,180	8,860	8,520	8,160
	84(28.9)	SHC	10,680	10,380	10,060	9,720	9,350
	88(28.9)	SHC	11,870	11,570	11,250	10,910	10,540
75 (23.9)		TC	19,920	19,280	18,600	17,820	16,980
		CI	1.32	1.45	1.59	1.76	1.95
	76(24.4)	SHC	6,480	6,220	5,960	5,660	5,340
	80(26.7)	SHC	7,720	7,470	7,200	6,900	6,590
	84(28.9)	SHC	8,920	8,660	8,400	8,100	7,780
	88(28.9)	SHC	10,110	9,860	9,590	9,290	8,980

TC :Total Cooling Capacity (BTU/h)
 SHC:Sensible Heat Capacity (BTU/h)
 CI :Compressor Input (kW)

Rating conditions are

:Outdoor Ambient Temp.95°FDB
 :Indoor Unit Entering Air Temp.80°FDB/67°FWB

5-4. Heating Capacity

Indoor unit **KHS0951 / KHS1251 / KHS1852**
Outdoor unit **CH0951 / CH1251 / CH1852**

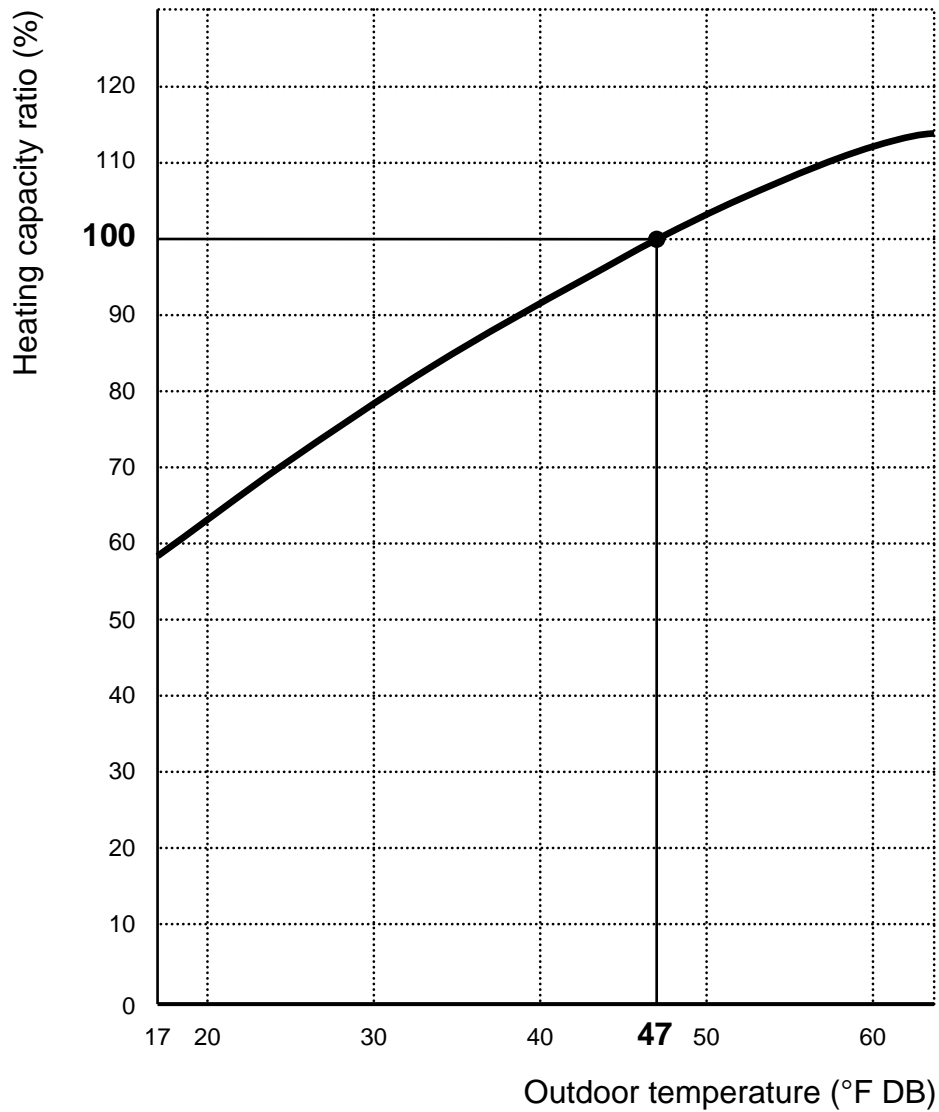

NOTE

- 1) ● ... Point of rating condition
Black dot in the chart indicates the following rating condition.
Indoor: 70°F (21.1°C) D.B.
Outdoor: 47°F (8.3°C) D.B. / 43°F (6.1°C) W.B.
- 2) Above characteristics indicate instantaneous operation, which does not take into account defrost operation.
- 3) Fan speed: High
- 4) Because this air conditioner heats a room by drawing in the heat of the outside air (heat pump system), the heating efficiency will fall off when the outdoor temperature is very low. If sufficient heat cannot be obtained with this air conditioner, use another heating appliance in conjunction with it.

6. ELECTRICAL DATA

6-1. Electrical Characteristics

Indoor Unit **KHS0951**
 Outdoor Unit **CH0951**

COOLING

		Indoor Unit	Outdoor Unit		Complete Unit
		Fan Motor	Fan Motor	Compressor	
Performance at		115V Single phase 60Hz			
Rating Conditions	Running Amps. A	0.40	0.70	7.4	8.5
	Power Input kW	0.034	0.081	0.775	0.89
Full Load Conditions	Running Amps. A	0.40	0.70	9.1	10.2
	Power Input kW	0.034	0.081	0.985	1.10

Rating Conditions : Indoor Air Temperature 80°F (26.7°C) D.B. / 67°F (19.4°C) W.B.
 Outdoor Air Temperature 95°F (35°C) D.B.

Full Load Conditions : Indoor Air Temperature 95°F (35°C) D.B. / 70°F (21.2°C) W.B.
 Outdoor Air Temperature 115°F (46.1°C) D.B.

HEATING

		Indoor Unit	Outdoor Unit		Complete Unit
		Fan Motor	Fan Motor	Compressor	
Performance at		115V Single phase 60Hz			
Rating Conditions	Running Amps. A	0.40	0.70	7.3	8.4
	Power Input kW	0.034	0.081	0.775	0.89
Full Load Conditions	Running Amps. A	0.40	0.70	8.6	9.7
	Power Input kW	0.034	0.081	0.935	1.05

Rating Conditions : Indoor Air Temperature 70°F (21.1°C) D.B.
 Outdoor Air Temperature 47°F (8.3°C) D.B. / 43°F (6.1°C) W.B.

Full Load Conditions : Indoor Air Temperature 80°F (26.7°C) D.B.
 Outdoor Air Temperature 75°F (23.9°C) D.B. / 65°F (18.3°C) W.B.

Indoor Unit **KHS1251**
 Outdoor Unit **CH1251**

COOLING

		Indoor Unit	Outdoor Unit		Complete Unit
		Fan Motor	Fan Motor	Compressor	
Performance at		115V Single phase 60Hz			
Rating Conditions	Running Amps. A	0.40	0.70	9.4	10.5
	Power Input kW	0.034	0.081	1.085	1.20
Full Load Conditions	Running Amps. A	0.40	0.70	11.8	12.9
	Power Input kW	0.034	0.081	1.365	1.48

Rating Conditions : Indoor Air Temperature 80°F (26.7°C) D.B. / 67°F (19.4°C) W.B.
 Outdoor Air Temperature 95°F (35°C) D.B.

Full Load Conditions : Indoor Air Temperature 95°F (35°C) D.B. / 70°F (21.2°C) W.B.
 Outdoor Air Temperature 115°F (46.1°C) D.B.

HEATING

		Indoor Unit	Outdoor Unit		Complete Unit
		Fan Motor	Fan Motor	Compressor	
Performance at		115V Single phase 60Hz			
Rating Conditions	Running Amps. A	0.40	0.70	9.2	10.3
	Power Input kW	0.034	0.081	1.055	1.17
Full Load Conditions	Running Amps. A	0.40	0.70	10.9	12.0
	Power Input kW	0.034	0.081	1.255	1.37

Rating Conditions : Indoor Air Temperature 70°F (21.1°C) D.B.
 Outdoor Air Temperature 47°F (8.3°C) D.B. / 43°F (6.1°C) W.B.

Full Load Conditions : Indoor Air Temperature 80°F (26.7°C) D.B.
 Outdoor Air Temperature 75°F (23.9°C) D.B. / 65°F (18.3°C) W.B.

Indoor Unit **KHS1852**
 Outdoor Unit **CH1852**

COOLING

			Indoor Unit	Outdoor Unit		Complete Unit		
			Fan Motor	Fan Motor	Compressor			
Performance at			230 / 208V Single phase 60Hz					
Rating Conditions	Running Amps.	A	0.25 / 0.23	0.49 / 0.46	6.86 / 7.41	7.6 / 8.1		
	Power Input	kW	0.047 / 0.045	0.113 / 0.095	1.54 / 1.52	1.70 / 1.66		
Full Load Conditions	Running Amps.	A	0.25 / 0.23	0.49 / 0.46	8.8 / 9.7	9.5 / 10.4		
	Power Input	kW	0.047 / 0.045	0.113 / 0.095	1.98 / 1.98	2.14 / 2.12		

Rating Conditions : Indoor Air Temperature 80°F (26.7°C) D.B. / 67°F (19.4°C) W.B.
 Outdoor Air Temperature 95°F (35°C) D.B.

Full Load Conditions : Indoor Air Temperature 95°F (35°C) D.B. / 70°F (21.2°C) W.B.
 Outdoor Air Temperature 115°F (46.1°C) D.B.

HEATING

			Indoor Unit	Outdoor Unit		Complete Unit		
			Fan Motor	Fan Motor	Compressor			
Performance at			230 / 208V Single phase 60Hz					
Rating Conditions	Running Amps.	A	0.25 / 0.23	0.49 / 0.46	6.36 / 6.81	7.1 / 7.5		
	Power Input	kW	0.047 / 0.045	0.113 / 0.095	1.45 / 1.40	1.61 / 1.54		
Full Load Conditions	Running Amps.	A	0.25 / 0.23	0.49 / 0.46	8.6 / 9.4	9.3 / 10.1		
	Power Input	kW	0.047 / 0.045	0.113 / 0.095	1.94 / 1.92	2.10 / 2.06		

Rating Conditions : Indoor Air Temperature 70°F (21.1°C) D.B.
 Outdoor Air Temperature 47°F (8.3°C) D.B. / 43°F (6.1°C) W.B.

Full Load Conditions : Indoor Air Temperature 80°F (26.7°C) D.B.
 Outdoor Air Temperature 75°F (23.9°C) D.B. / 65°F (18.3°C) W.B.

6-2. Electric Wiring Diagrams

(1) Indoor unit KHS0951 / KHS1251

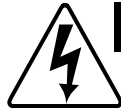

WARNING

To avoid electrical shock hazard, be sure to disconnect power before checking, servicing and/or cleaning any electrical parts.

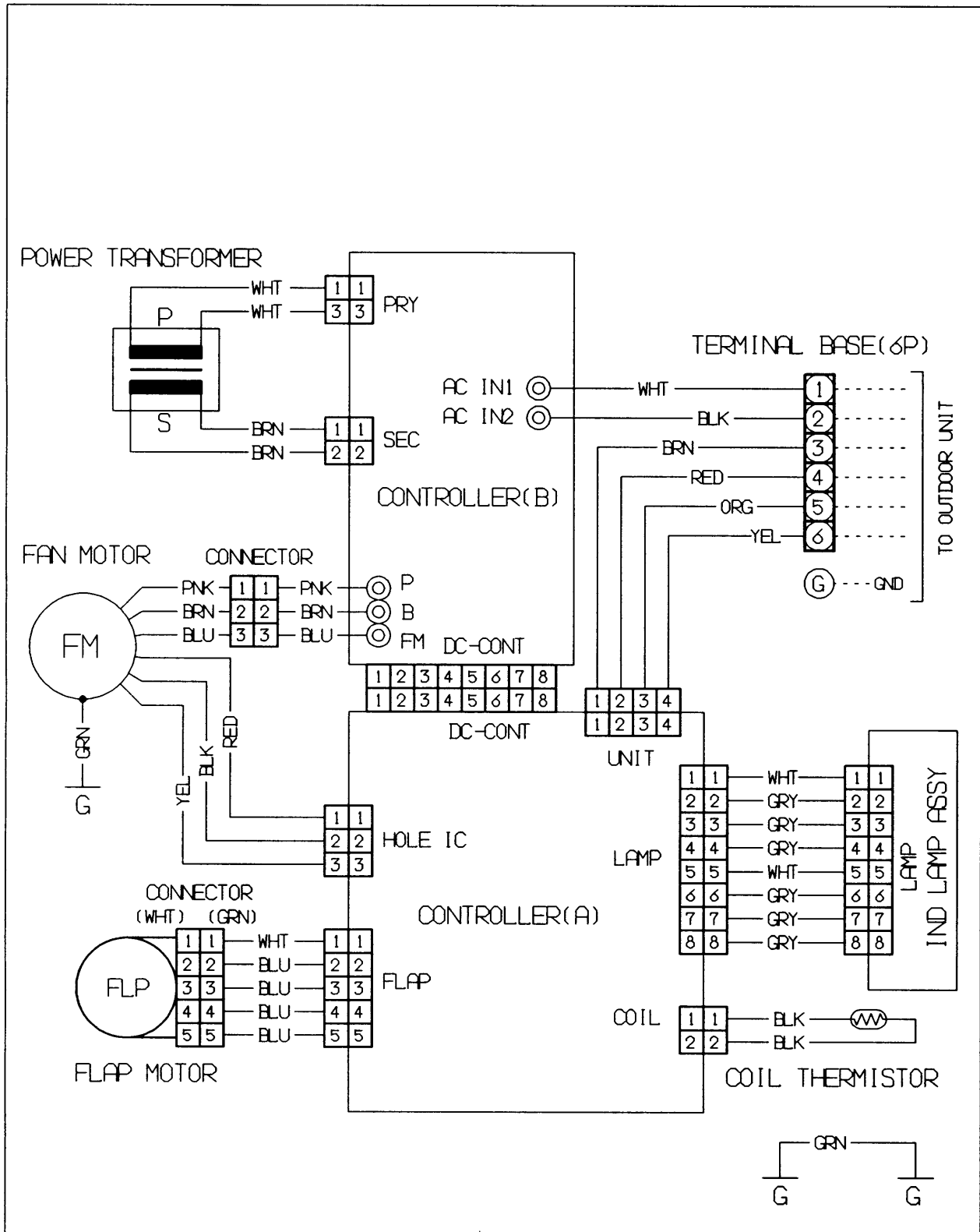

8512-5253-561XX-1

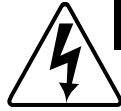

WARNING

To avoid electrical shock hazard, be sure to disconnect power before checking, servicing and/or cleaning any electrical parts.

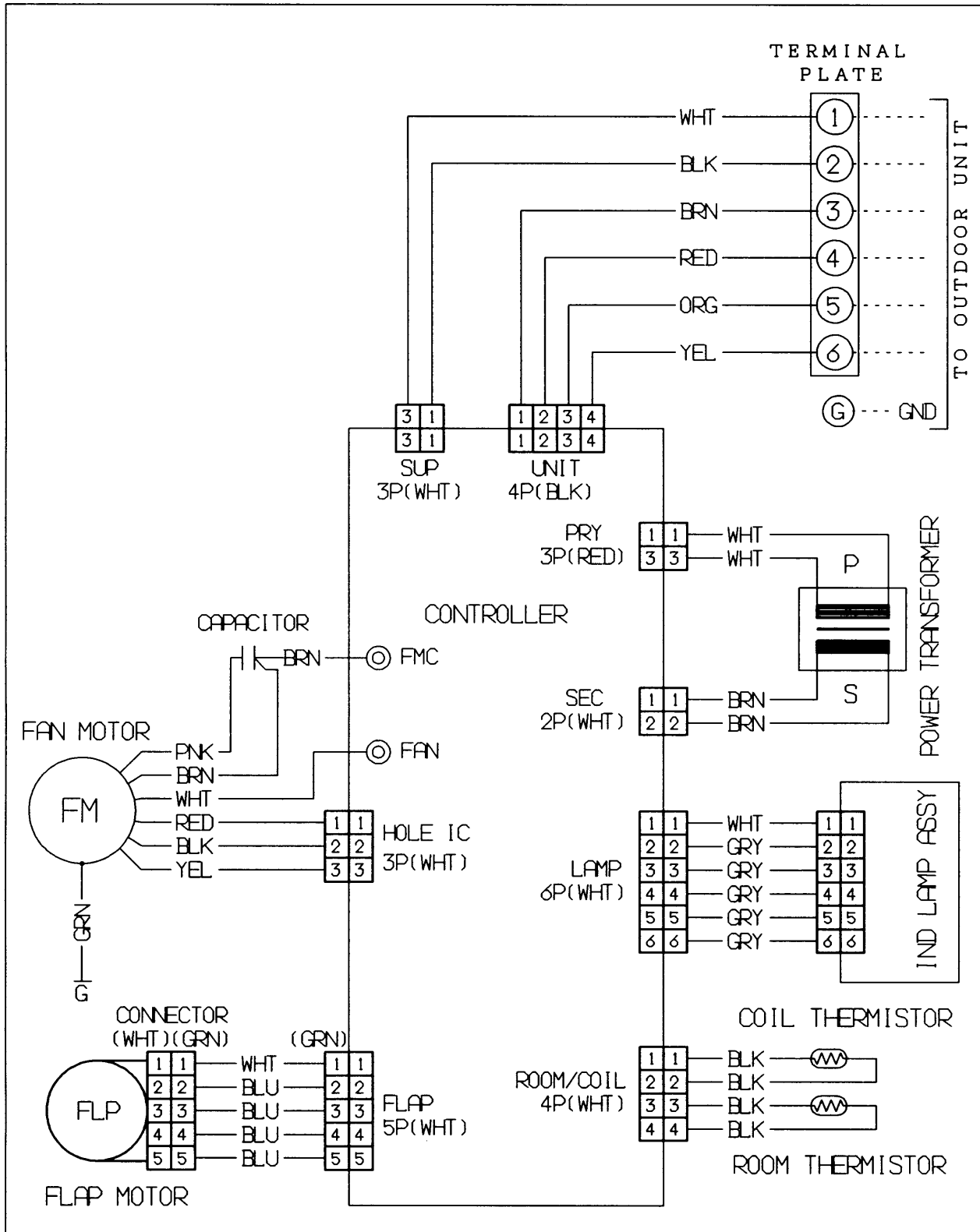

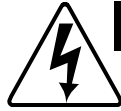

WARNING

To avoid electrical shock hazard, be sure to disconnect power before checking, servicing and/or cleaning any electrical parts.

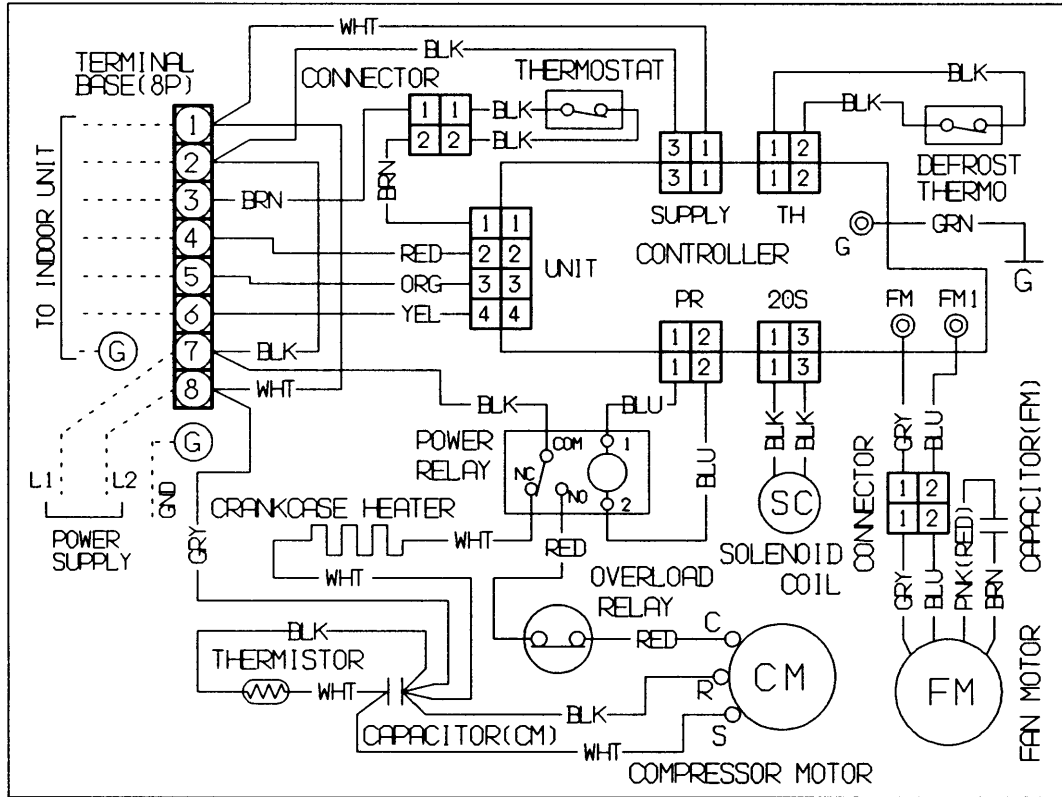

8512-5253-562XX-0

(4) Outdoor unit CH1852

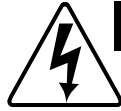

WARNING

To avoid electrical shock hazard, be sure to disconnect power before checking, servicing and/or cleaning any electrical parts.

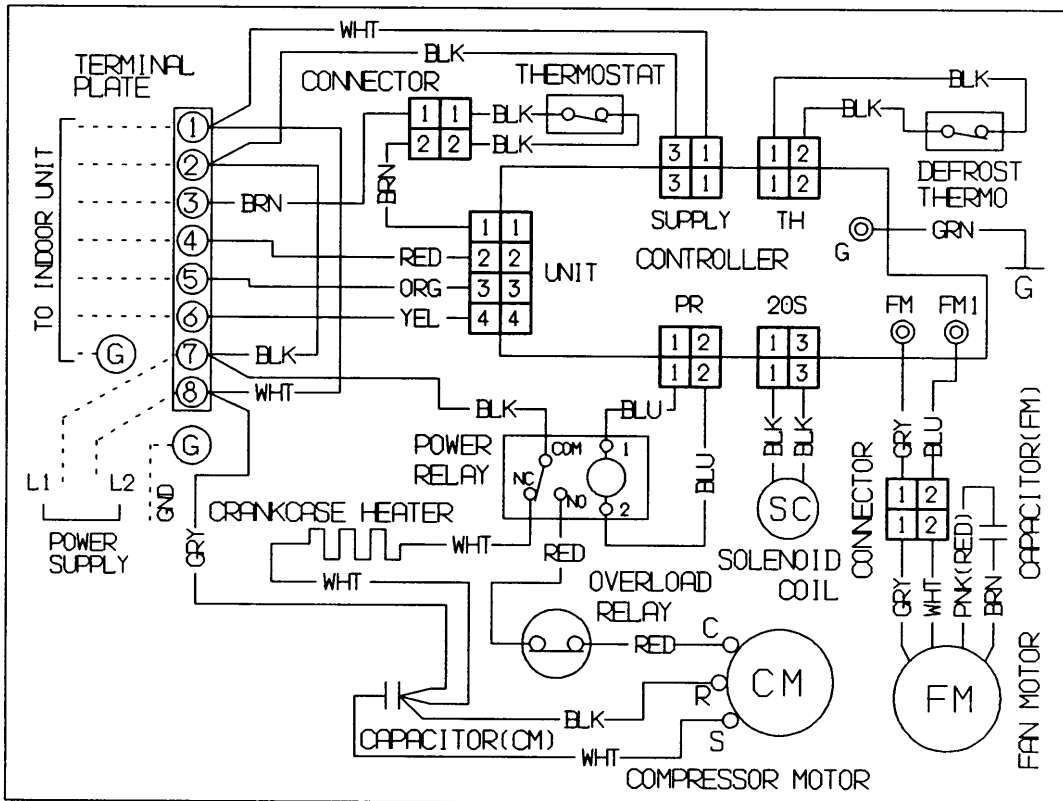

8512-5253-589XX-0

(5) Printed circuit board POW-KHS095A (for KHS0951)

Top view

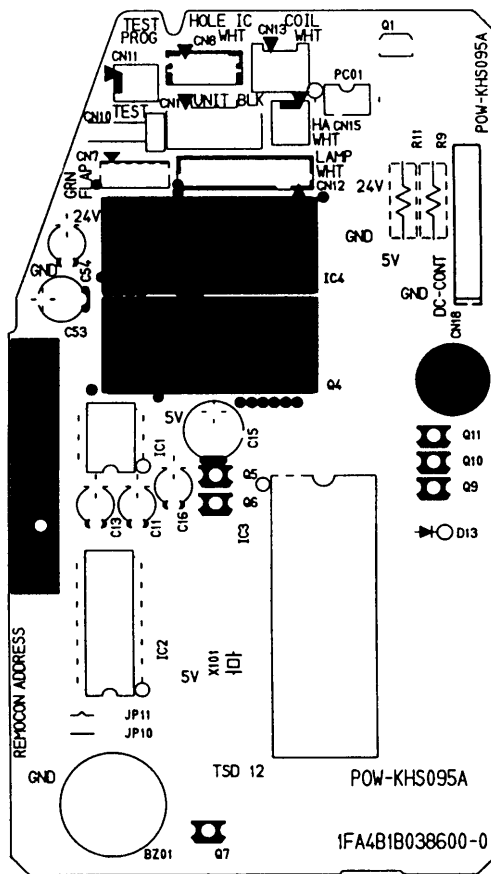

Bottom view

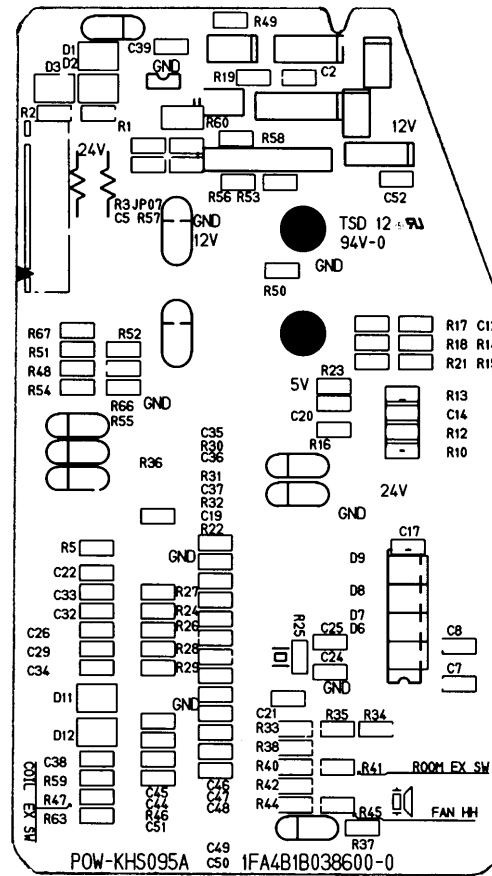

(6) Printed circuit board **POW-KHS125A (for KHS1251)**

Top view

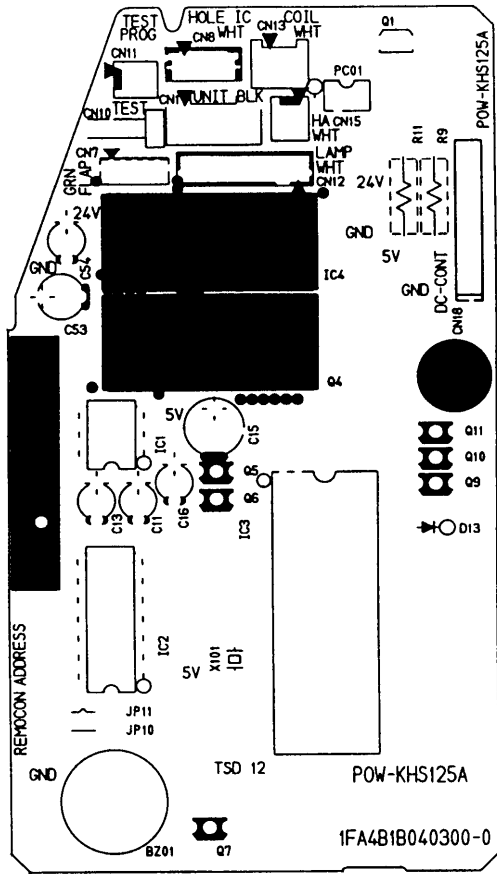

Bottom view

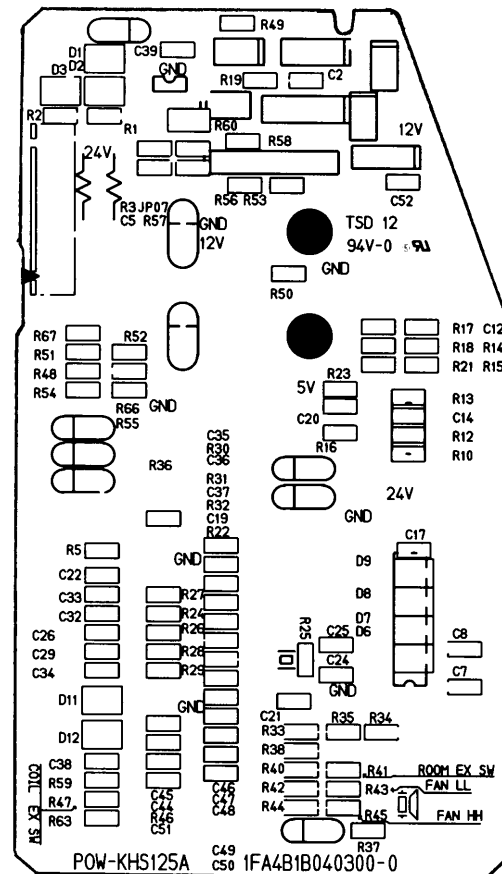

(7) Printed circuit board **POW-KHS095B (for KHS0951 and KHS1251)**

Top view

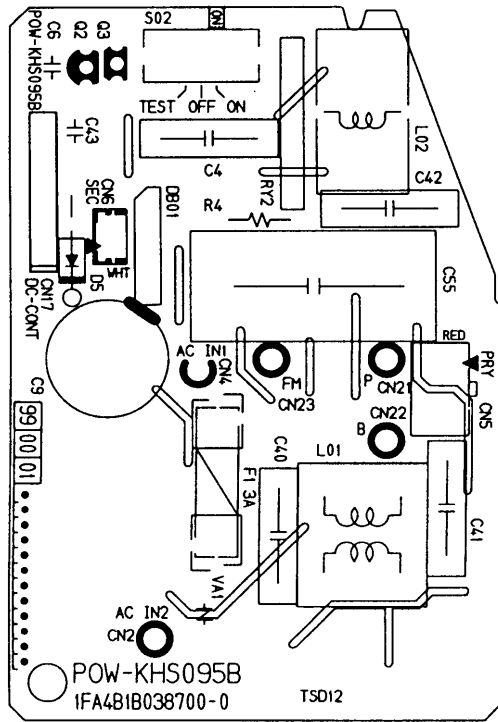

Bottom view

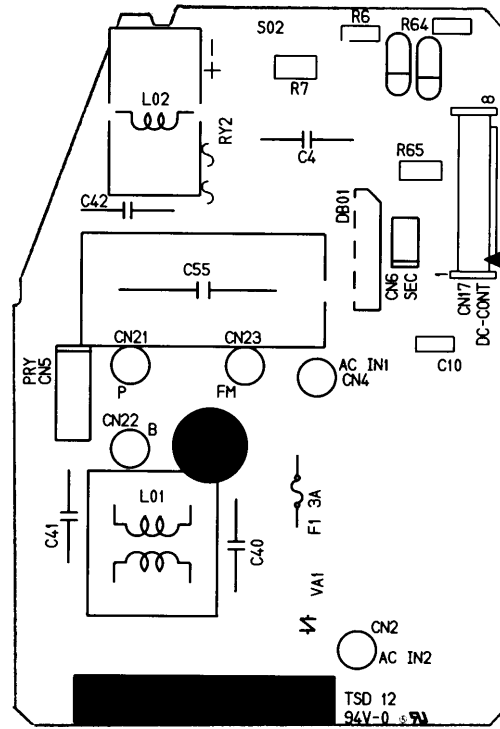

(8) Printed circuit board POW-KHS1852 (for KHS1852)

Top view

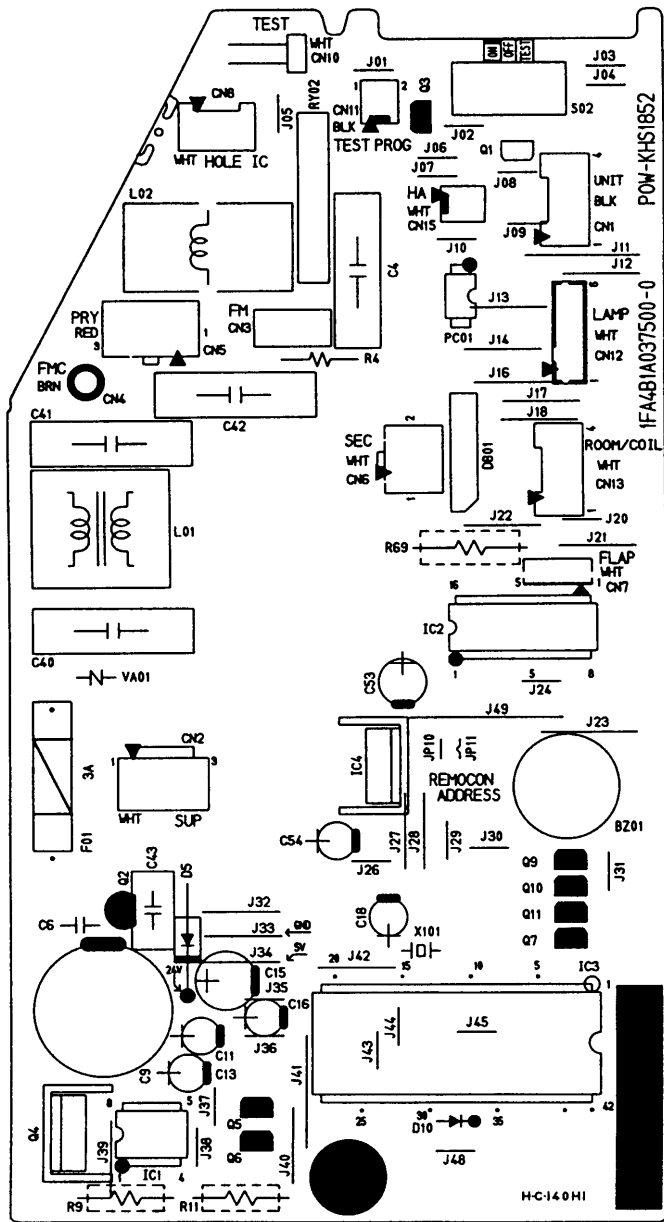

Bottom view

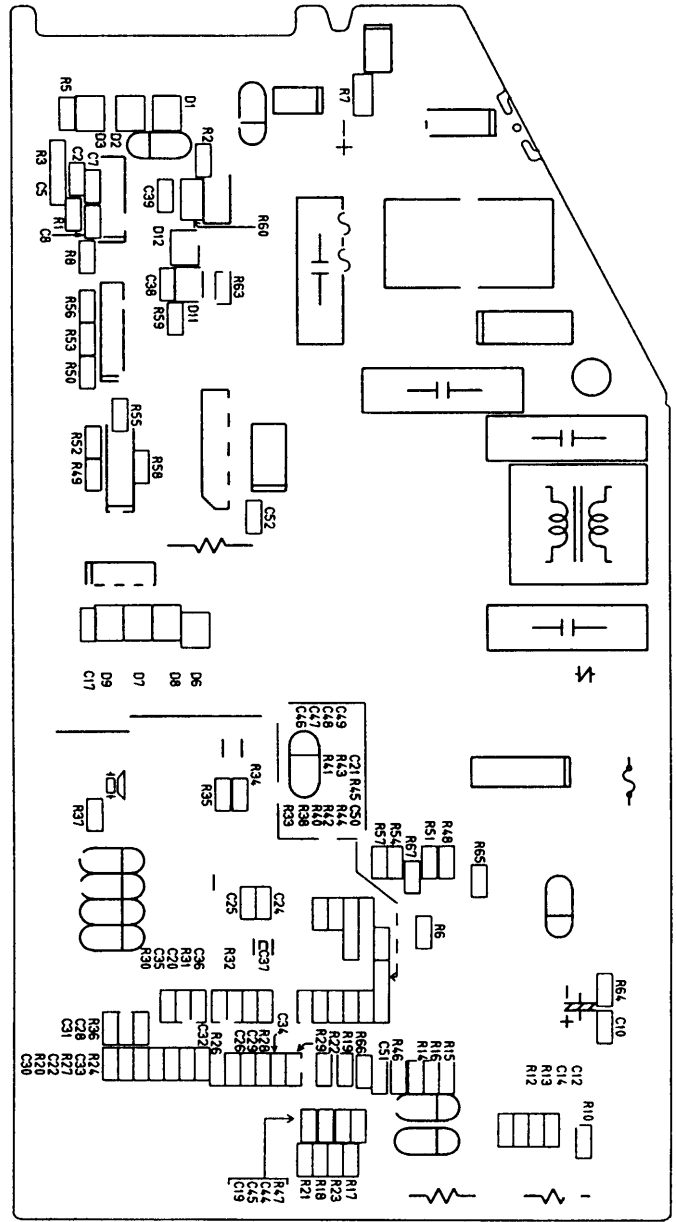

(9) Printed circuit board POW-CH095 (for CH0951, CH1251 and CH1852)

Top view

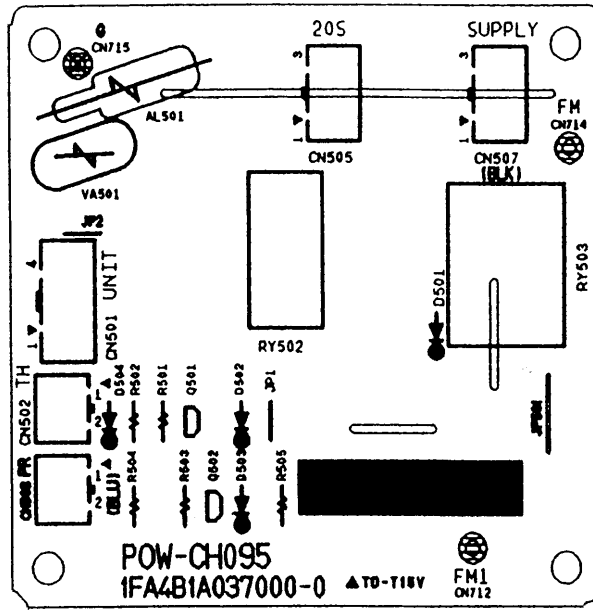

7. INSTALLATION INSTRUCTIONS

7-1. Installation Site Selection

7-1-1. Indoor Unit



WARNING

To prevent abnormal heat generation and the possibility of fire, do not place obstacles, enclosures and grilles in front of or surrounding the air conditioner in a way that may block air flow.

AVOID:

- direct sunlight.
- nearby heat sources that may affect performance of the unit.
- areas where leakage of flammable gas may be expected.
- places where large amounts of oil mist exist.

DO:

- select an appropriate position from which every corner of the room can be uniformly cooled. (High on a wall is best.)
- select a location that will hold the weight of the unit.
- select a location where tubing and drain hose have the shortest run to the outside. (Fig. 1)
- allow room for operation and maintenance as well as unrestricted air flow around the unit. (Fig. 2)
- install the unit within the maximum elevation difference (H) above the outdoor unit and within a total tubing length (L) from the outdoor unit as detailed in Table 1 and Fig. 3a.

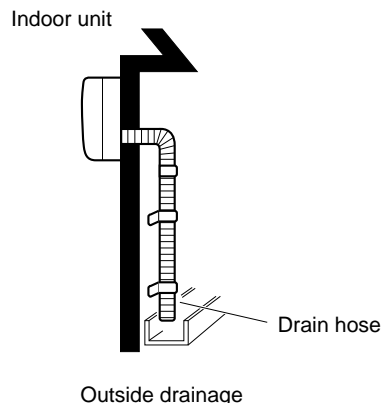

Fig. 1

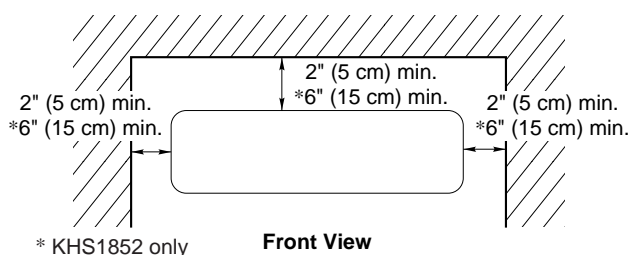

Fig. 2

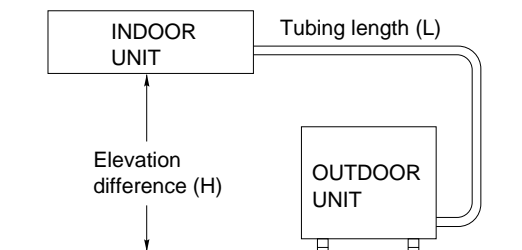

Fig. 3a



CAUTION

For stable operation of the air conditioner, do not install wall-mounted type indoor units under 5 ft. (1.5 m) from floor level.

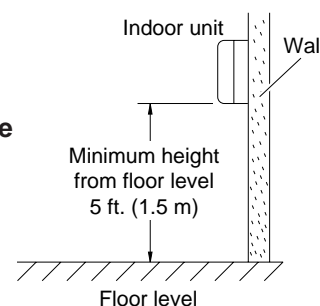

Fig. 3b

Table 1

Max. Allowable Tubing Length at Shipment (ft.)	Limit of Tubing Length (L) (ft.)	Limit of Elevation Difference (H) (ft.)	Required Amount of Additional Refrigerant (oz./ft.)*	Model
25	50	23	a) 0.16	9,000 BTU
25	65	23	b) 0.27	12,000/18,000 BTU

* If total tubing length becomes a) 25 to 50 ft. (max.), b) 25 to 65 ft. (max.) charge additional refrigerant (R22) by a) 0.16 oz./ft., b) 0.27 oz./ft. No additional compressor oil is necessary.

7-1-2. Outdoor Unit

AVOID:

- heat sources, exhaust fans, etc. (Fig. 4)
- damp, humid or uneven locations.

DO:

- choose a place as cool as possible.
- choose a place that is well ventilated.
- allow enough room around the unit for air intake/exhaust and possible maintenance. (Fig. 5a)



CAUTION

- **Install the outdoor unit above snowfall line.**
- **Do not place objects on or sit on the outdoor unit. Also, never block the air intake/outlet or exhaust. Distortion of the outdoor unit or incomplete combustion may result.**
- **Do not introduce foreign matter into the air intake/outlet or exhaust. Do not poke them with such objects as a stick.**

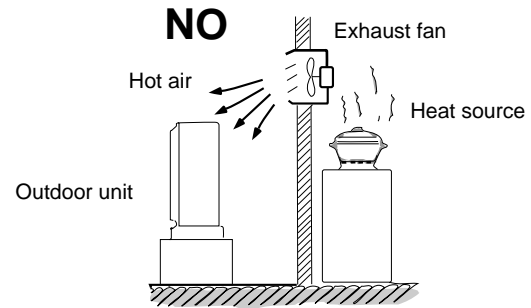

Fig. 4

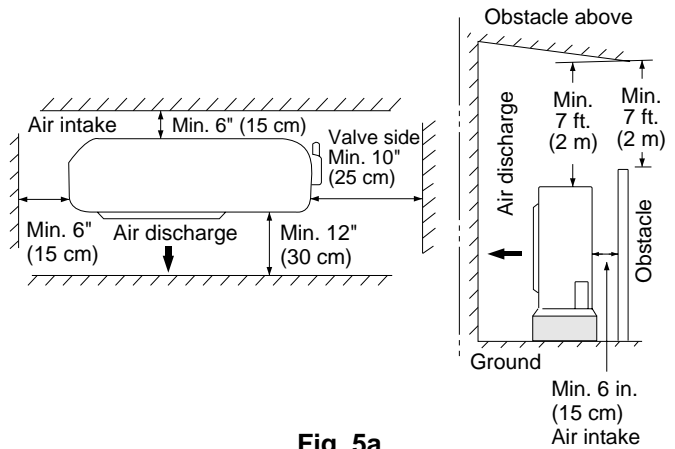

Fig. 5a

- provide a solid base (level concrete pad, concrete block, 4 in. × 16 in. (10 × 40 cm) beams or equal), a minimum of 4 in. (10 cm) above ground level to reduce humidity and protect the unit against possible water damage and decreased service life (Fig. 5b).
- use lug bolts or equal to bolt down unit, reducing vibration and noise.

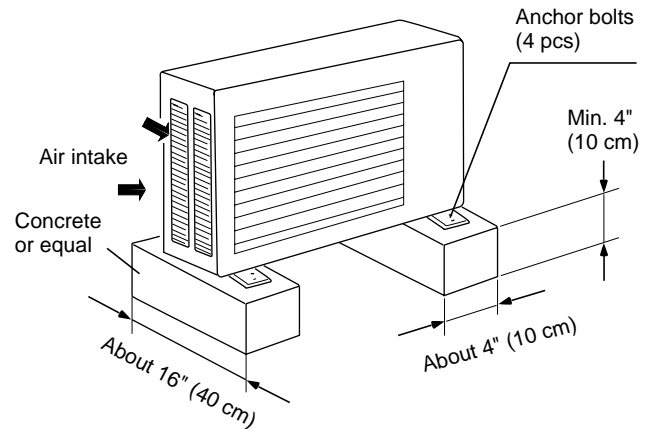

Fig. 5b

7-2. Remote Control Unit Installation Position

The remote control unit can be operated from either a non-fixed position or a wall-mounted position.

To ensure that the air conditioner operates correctly, do not install the remote control unit in the following places:

- In direct sunlight
- Behind a curtain or other place where it is covered
- More than 26 ft. (8 m) away from the air conditioner
- In the path of the air conditioner's airstream
- Where it may become extremely hot or cold
- Where it may be subject to electrical or magnetic interference

7-2-1. Mounting on a Wall

a) Removable mounting

- 1) Momentarily hold the remote control unit at the desired mounting position.
- 2) Confirm that the air conditioner responds correctly when you press keys on the remote control from that position.
- 3) After confirming correct operation, use a screwdriver to screw the supplied special mounting screw into the wall. (Fig. 6)
- 4) Hang the remote control unit from the mounting screw.

b) Non-removable mounting

- 1) Momentarily hold the remote control unit at the desired mounting position.
- 2) Confirm that the air conditioner responds correctly when you press keys on the remote control from that position.
- 3) After confirming correct operation, use a screwdriver to screw the mounting screw into the wall. (Fig. 6)
- 4) Remove the remote control cover by sliding it downward.
- 5) Remove the batteries of the remote control unit.
- 6) Use a screwdriver to screw the remote control unit securing screw into the wall through the hole in the battery compartment. (Fig. 7)
- 7) Replace the batteries.
- 8) Again confirm that the remote control unit operates correctly.

Removable mounting

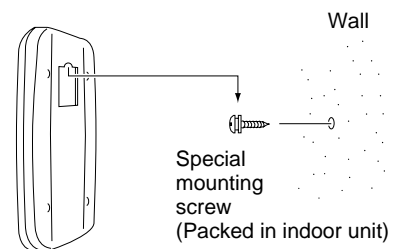

Fig. 6

Non-removable mounting

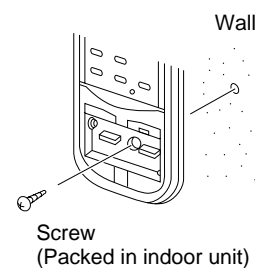
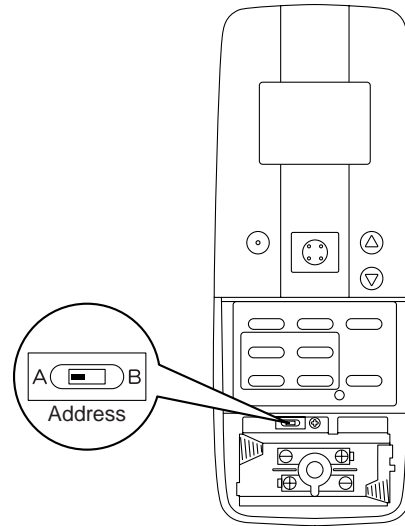

Fig. 7

7-3. Address Switches

If you are installing more than 1 indoor unit (up to 2) in the same room, it is necessary for you to assign each unit its own address so each can be operated by its own remote control unit. You assign the addresses by matching the switch positions of each indoor unit with the switch positions of its remote control unit. The switches of the remote control unit are shown in Fig. 8.

For instance, to set up 2 indoor units, switch Unit A's address switches. Then switch Unit B's address switches. *It is important that you match the switches of the air conditioner unit with the switches of its remote control unit.*



NOTE

Address switch is in "A" position at time of shipment.

Fig. 8

7-3-1. Finding the Address Switches

Remote Control Unit

Remove the lid and unit's 2 batteries. You can see the switches inside the battery compartment. (Fig. 8)



WARNING Be sure to turn the air conditioner off and disconnect the power before opening the unit.



Risk of Electric Shock

KHS0951, KHS1251

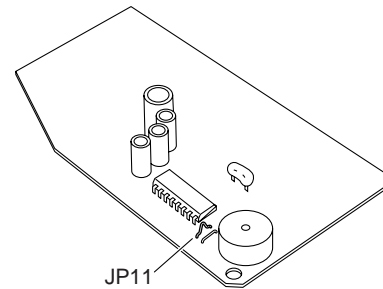

Fig. 9

7-3-2. Switch Positions for Up to 2 Units

Indoor Unit

Remove the casing, then follow the steps below.

- a) Unscrew the cover plate of the electrical component box. Remove the PCB. Locate and cut the jumper wire. (Figs. 9 and 10)
- b) Table 2 shows the positions you can use for up to 2 indoor units installed in the same room. (Figs. 8, 9 and 10)

KHS1852

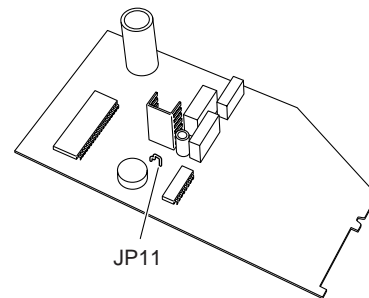

Fig. 10

Table 2

Unit No.	Remote Control Address	Indoor Unit Jumper Wire
		JP11
1	A	Do not cut
2	B	Cut

NOTE

An indoor unit cannot be remote controlled if its remote control unit is too far away (more than 26 ft.). If the remote control unit does not seem to work correctly, bring it closer to the unit being operated and try again. For this reason, if the remote control unit is to be used from a fixed position, operation should be checked at that position before mounting.

7-4. Recommended Wire Length and Diameter

Regulations on wiring diameter differ from locality to locality. For field wiring requirements, please refer to your local electrical codes. Carefully observe these regulations when carrying out the installation.

NOTE

Refer to the wiring system diagram (Fig. 11)

Refer to your local codes or in the absence of local codes with the National Electric Code: ANSI/NFPA70.



WARNING

- Be sure to comply with local codes on running the wire from the outdoor unit to the indoor unit (size of wire and wiring method, etc.).
- Each wire must be firmly connected.
- No wire should be allowed to touch refrigerant tubing, the compressor, or any moving part.



WARNING

- To avoid the risk of electric shock, each air conditioner unit must be grounded.



CAUTION

- Be sure to connect the power supply line to the outdoor unit as shown in the wiring diagram. The indoor unit draws its power from the outdoor unit.

WIRING SYSTEM DIAGRAM

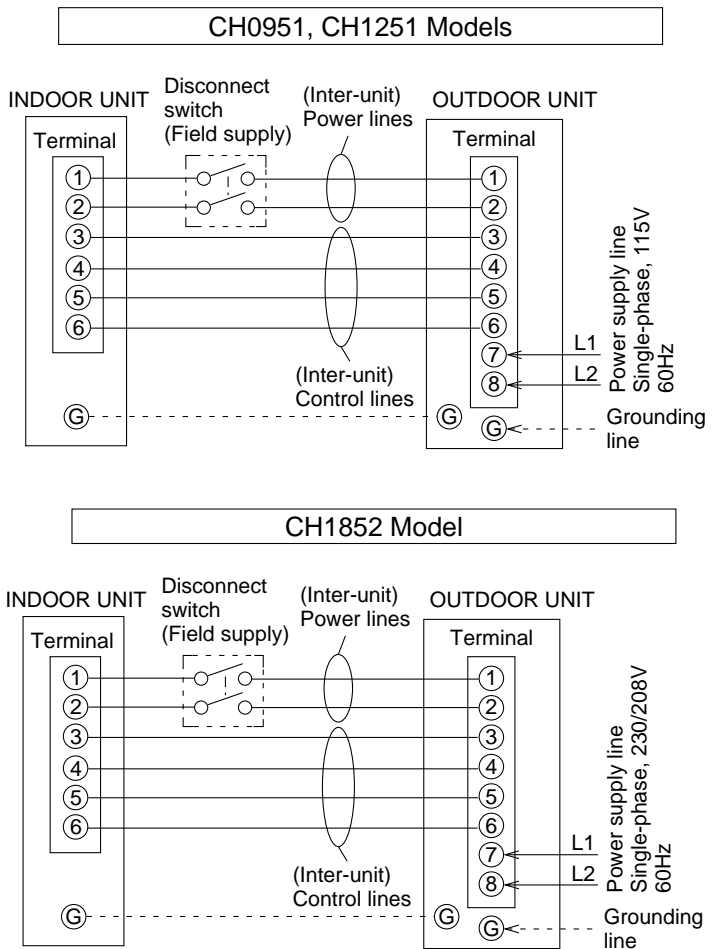

Fig. 11

8. FUNCTION

8-1. Room Temperature Control

■ Cooling

- Room temperature control is obtained by cycling the compressor ON and OFF under control of the room temperature sensor in the remote control unit.
- The room temperature (and other information) is transmitted every 3 minutes by the remote control unit to the controller in the indoor unit.

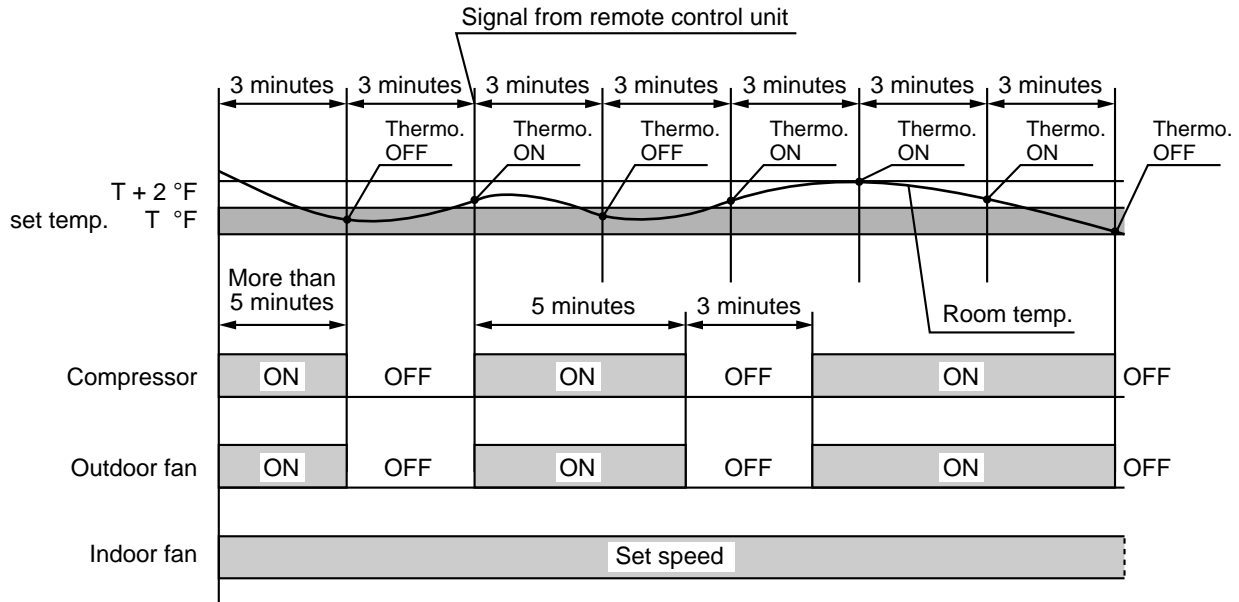

- The control circuit will not attempt to turn the compressor ON until the compressor has been OFF for at least 3 minutes. To protect the compressor from stalling out when trying to start against the high side refrigerant pressure, the control circuit has a built-in automatic time delay to allow the internal pressure to equalize.
- As a protective measure, the control circuit switches the compressor OFF after 5 minutes or more of compressor operation.
- Thermo. ON : When the room temperature is above $T + 2^{\circ}\text{F}$ ($T^{\circ}\text{C}$ is set temperature).
Compressor → ON
- Thermo. OFF : When the room temperature is equal to or below set temperature $T^{\circ}\text{F}$.
Compressor → OFF

■ Heating

- Room temperature control is obtained by cycling the compressor ON and OFF under control of the room temperature sensor in the remote control unit.
- The room temperature (and other information) is transmitted every 3 minutes by the remote control unit to the controller in the indoor unit.

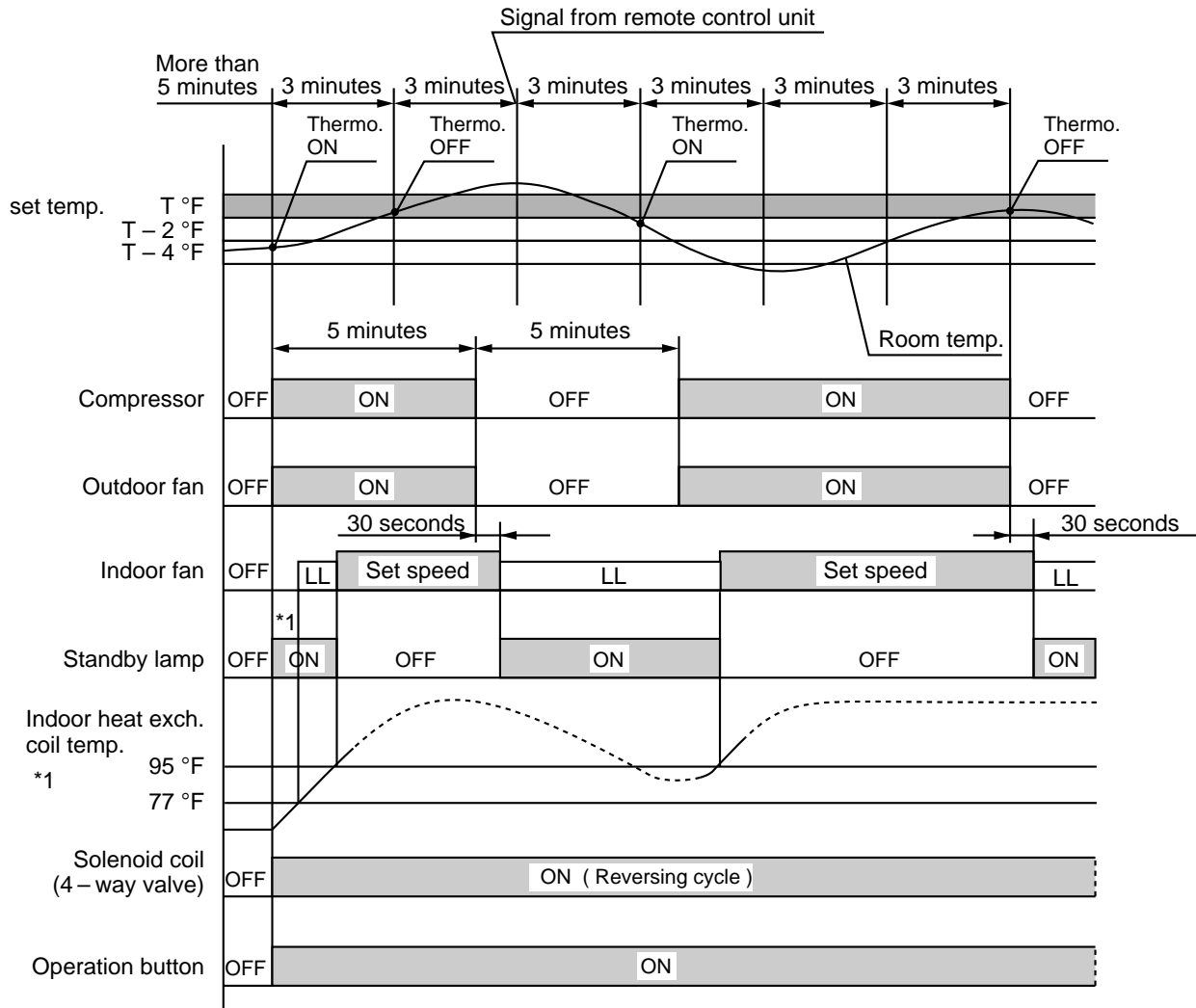

- The control circuit will not attempt to turn the compressor ON until the compressor has been OFF for at least 5 minutes. To protect the compressor from stalling out when trying to start against the high side refrigerant pressure, the control circuit has a built-in automatic time delay to allow the internal pressure to equalize.
- As a protective measure, the control circuit switches the compressor OFF after 5 minutes or more of compressor operation.
- Thermo. ON : When the room temperature is below $T - 2^\circ\text{F}$ ($T^\circ\text{C}$ is set temperature).
Compressor \rightarrow ON
- Thermo. OFF : When the room temperature is equal to or above set temperature $T^\circ\text{F}$.
Compressor \rightarrow OFF

NOTE

*1: Refer to "8-6 Cold Draft Prevention".

8-2. Dry Operation (Dehumidification)

- Dry operation uses the ability of the cooling cycle to remove moisture from the air, but by running at low level to dehumidify without greatly reducing the room temperature. The air conditioner repeats the cycle of turning ON and OFF automatically as shown in the chart below according to the room temperature.

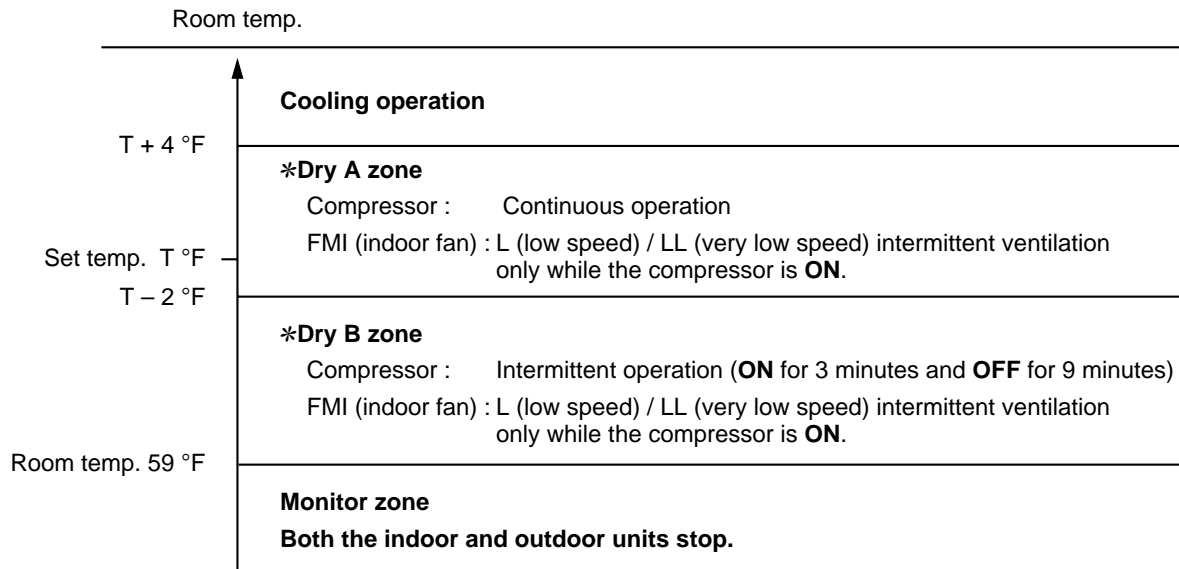

NOTE

- Intermittent ventilation occurs by switching the indoor fan speed between L ↔ LL.
- Dry operation does not occur when the room temperature is under 15°C, which is the monitor zone.
- When the compressor stops, the indoor fan stops as well.

8-3. Automatic Switching between Cooling and Heating

- When AUTO mode is selected, the microprocessor calculates the difference between the set temperature and the room temperature, and automatically switches to COOLING or HEATING mode to maintain the desired temperature.

Room temp. ≥ Set temp. → COOL

Room temp. < Set temp. → HEAT

This means that if the room temperature is **higher than** or **equal to** the set temperature, **COOLING** operation begins. If the room temperature is **lower than** the set temperature, **HEATING** operation begins.

8-4. Freeze Prevention (Cooling)

- This function prevents freezing of the indoor heat exchange coil.
- When the compressor has been running for 10 minutes or more and the temperature of the indoor heat exchange coil falls below 30°F, the control circuit stops the compressor for at least 6 minutes. The compressor does not start again until the temperature rises above 46°F or 6 minutes has elapsed.

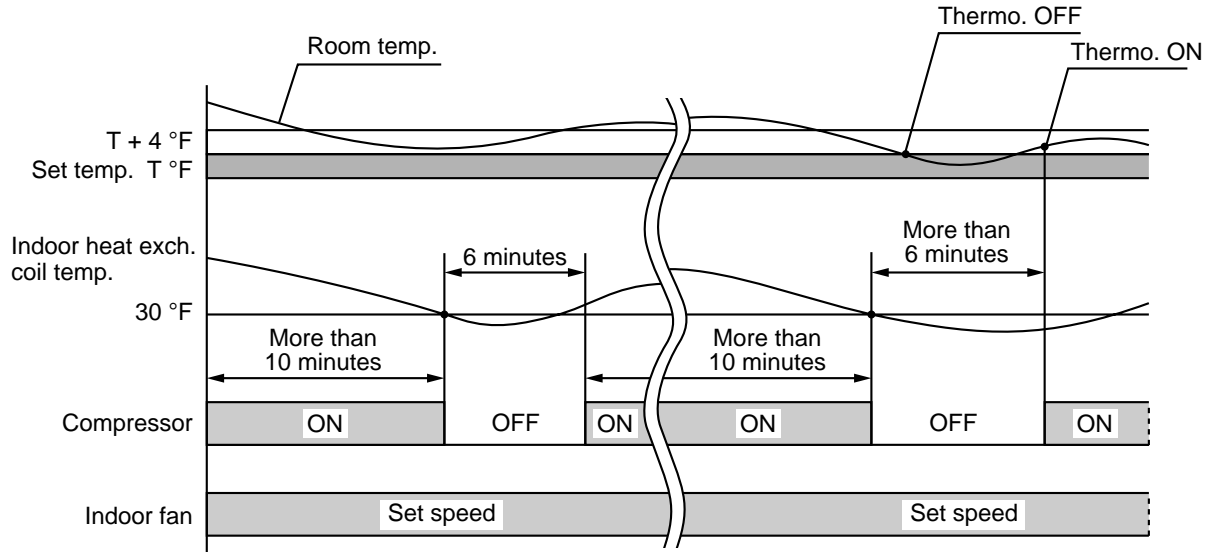

8-5. Overload Prevention (Heating)

- This function prevents overheating of the indoor heat exchange coil.
- When the temperature of the indoor heat exchange coil rises above **139°F**, and if the indoor fan is L (low speed), then the fan speed changes from L (low speed) to M (medium speed).
- When the temperature of the indoor heat exchange coil rises above **141°F**, the outdoor fan stops.

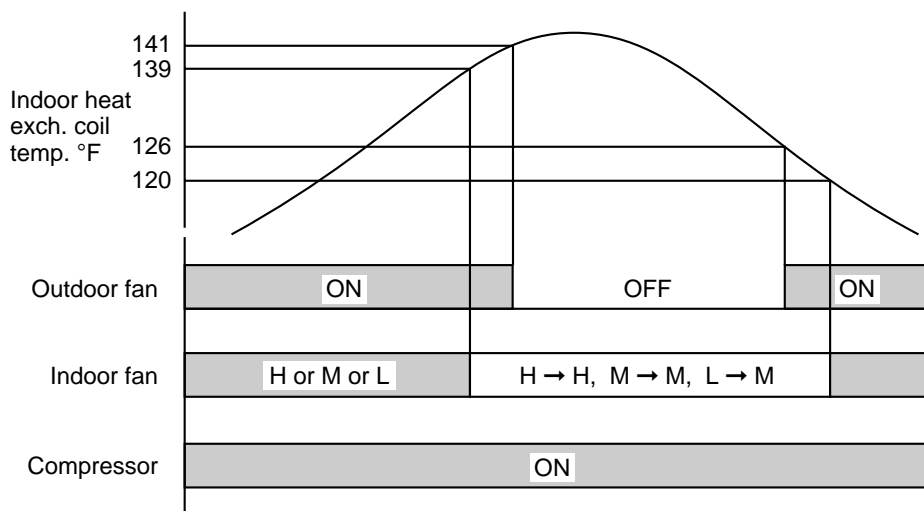

8-6. Cold draft Prevention (Heating)

- This function controls indoor fan speed so a strong draft of cold air will not blow out before the indoor heat exchange coil have sufficiently warmed up.
- STANDBY lamp on front of the indoor unit lights up when this function is working.
- when 10 minutes has elapsed, the fan speed is automatically switched to set speed regardless of indoor heat exchange coil temperature.

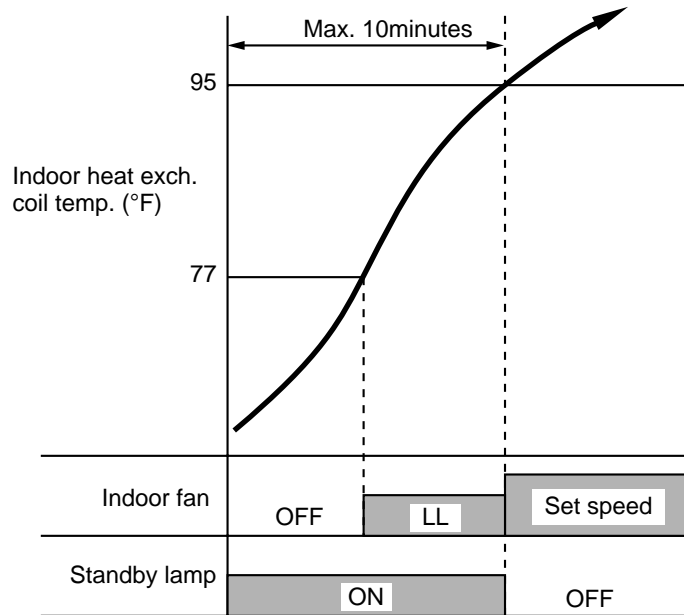

8-7. Defrosting Operation (Heating)

■ Defrosting Flowchart

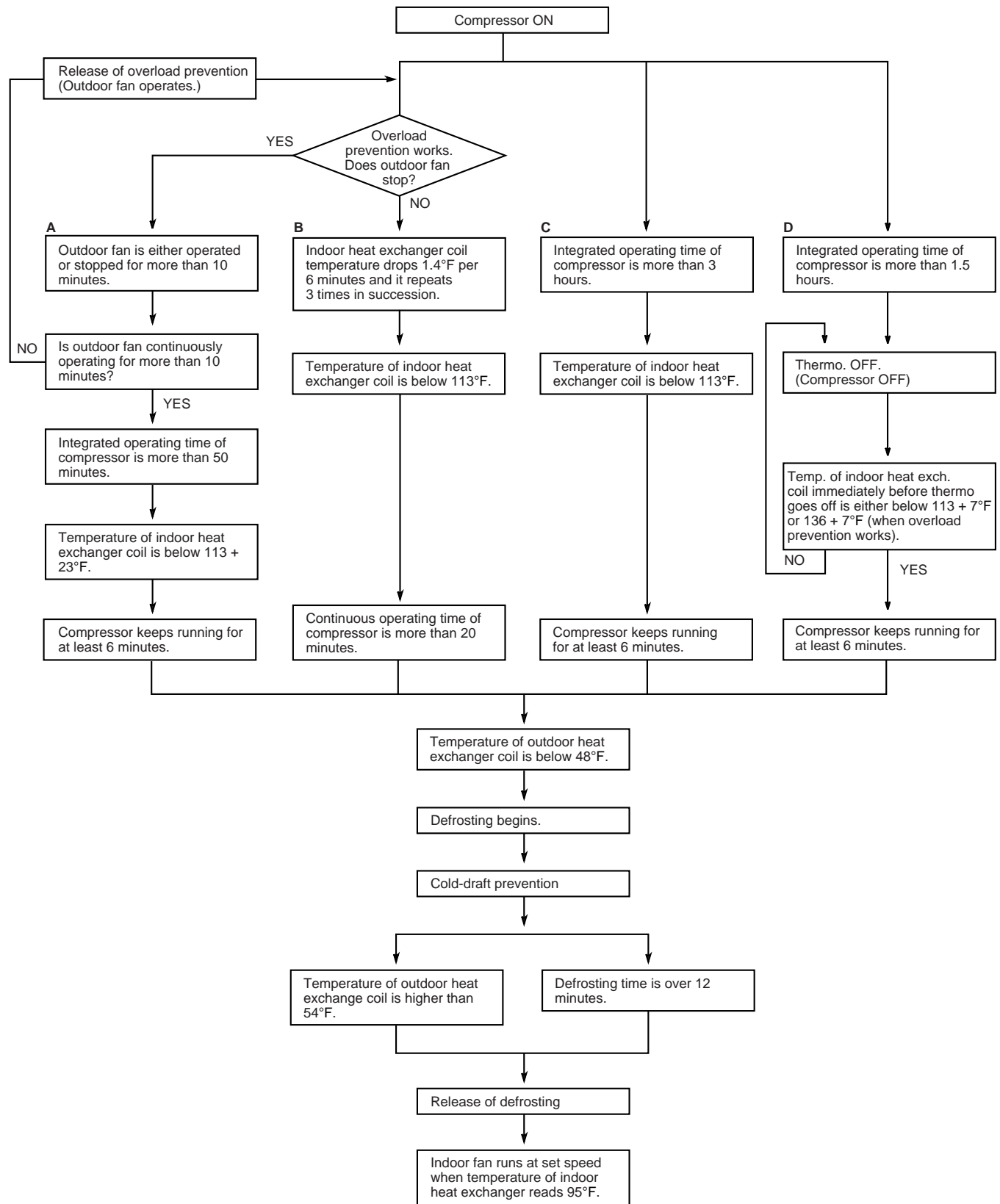

■ Defrosting Mode Timing Chart

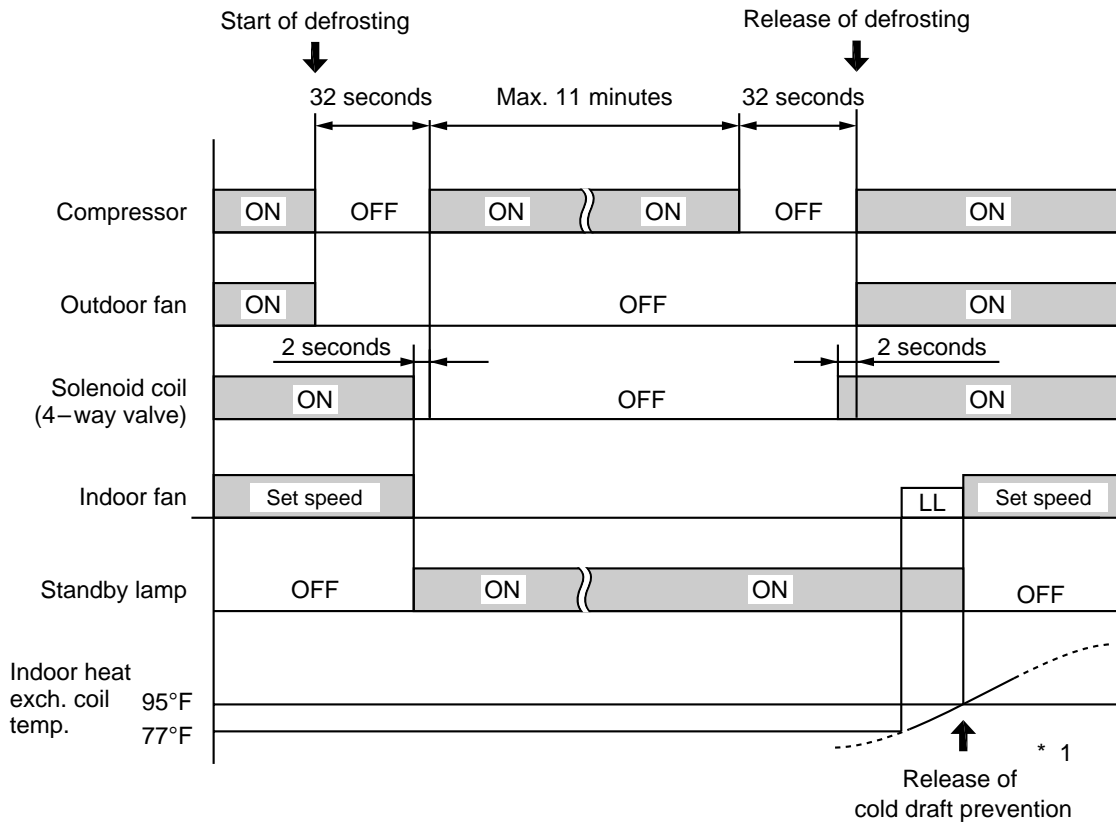

NOTE

*1: Refer to "8-6 Cold Draft Prevention".

8-8. Low Temperature Cutoff (Heating)

- This function protects the compressor from being damaged due to flow back of the liquid refrigerant to the compressor when the outdoor temperature is very low.
- Low ambient operation during heating can cause the outdoor heat exchanger to become super-cooled which may result in liquid back-flow. To protect the compressor from this condition, both compressor and outdoor fan stop if the outdoor temperature drops around 5°F. However, the indoor fan continues to operate even after the compressor has stopped. Note that standby lamp does not light up during this period.

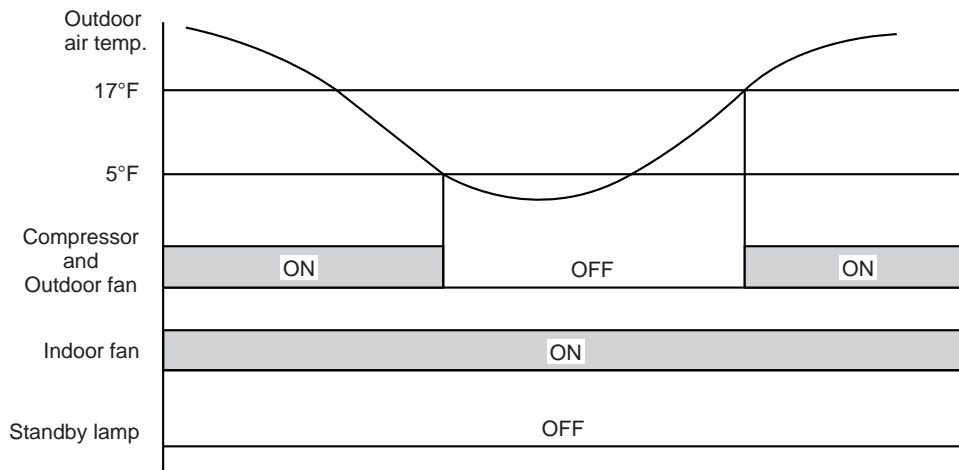

9. TROUBLESHOOTING

9-1. Check before and after troubleshooting



WARNING

Hazardous voltage can cause **ELECTRIC SHOCK** or **DEATH**. Disconnect power or turn off circuit breaker before you start checking or servicing.

9-1-1. Check power supply wiring.

- Check that power supply wires are correctly connected to terminals **No. 7 (L1)** and **No. 8 (L2)** on the terminal plate in the outdoor unit.

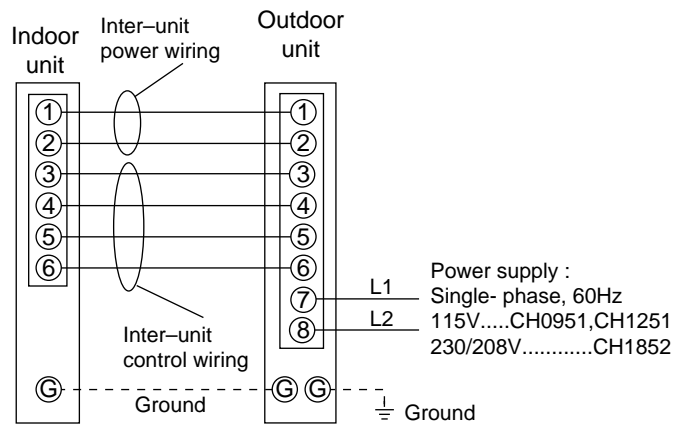

9-1-2. Check inter-unit wiring.

- Check that inter-unit wiring is correctly connected to the indoor unit from the outdoor unit.

9-1-3. Check power supply.

- Check that voltage is in specified range ($\pm 10\%$ of the rating).
- Check that power is being supplied.

9-1-4. Check lead wires and connectors in indoor and outdoor units.

- Check that coating of lead wires is not damaged.
- Check that lead wires and connectors are firmly connected.
- Check that wiring is correct.

9-2. Air conditioner does not operate.

9-2-1. Circuit breaker trips (or fuse blows).

A. When the circuit breaker is set to ON, it is tripped soon. (Resetting is not possible.)

- There is a possibility of ground fault.
- Check insulation resistance.

If resistance value is $2M\Omega$ or less, insulation is defective (“NO”).

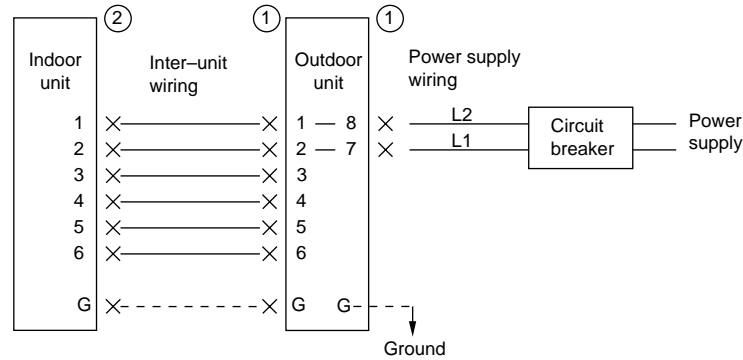

WARNING

* Set circuit breaker to OFF.

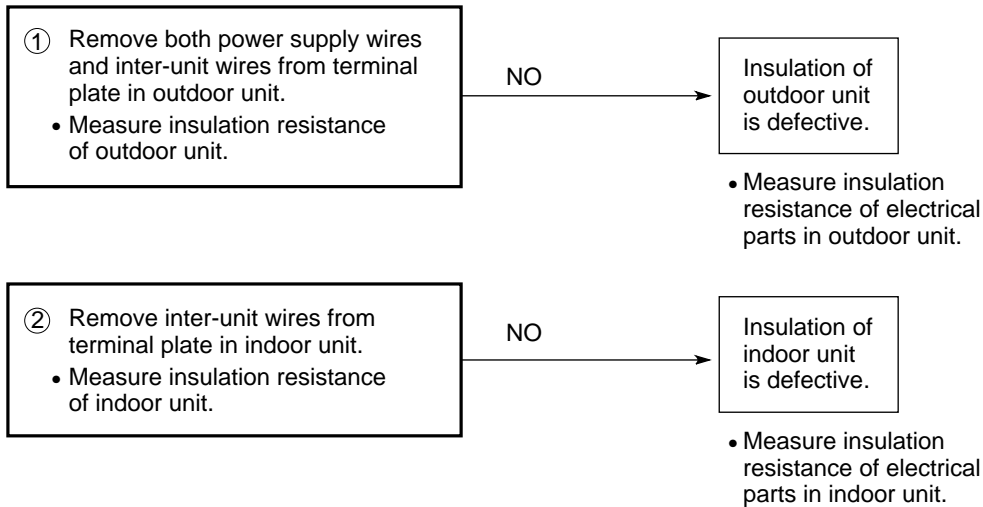

B. Circuit breaker trips in several minutes after turning the air conditioner on.

- There is a possibility of short circuit.

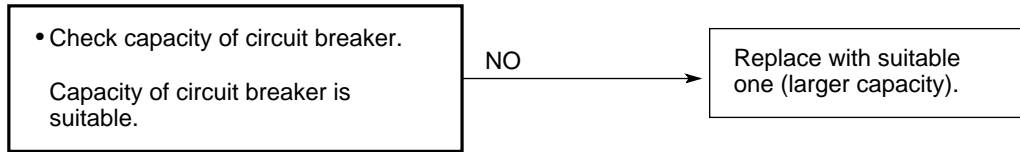

In case of Heating operation :

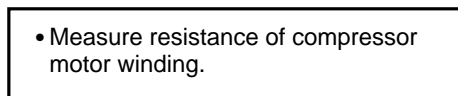
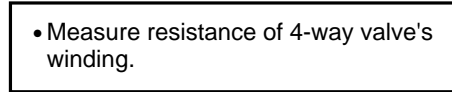
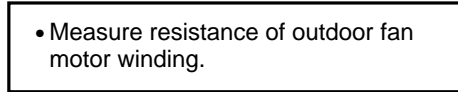

9-2-2. Neither indoor nor outdoor unit runs.

A. Power is not supplied.

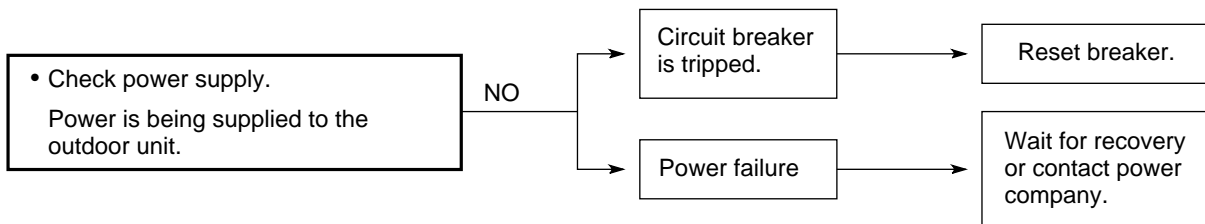

B. Check "OPERATION selector" switch in the indoor unit.

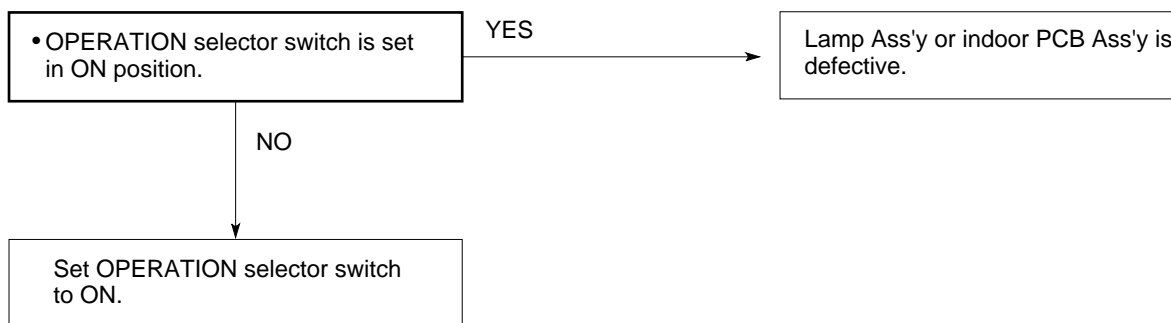

C. Check remote control unit.

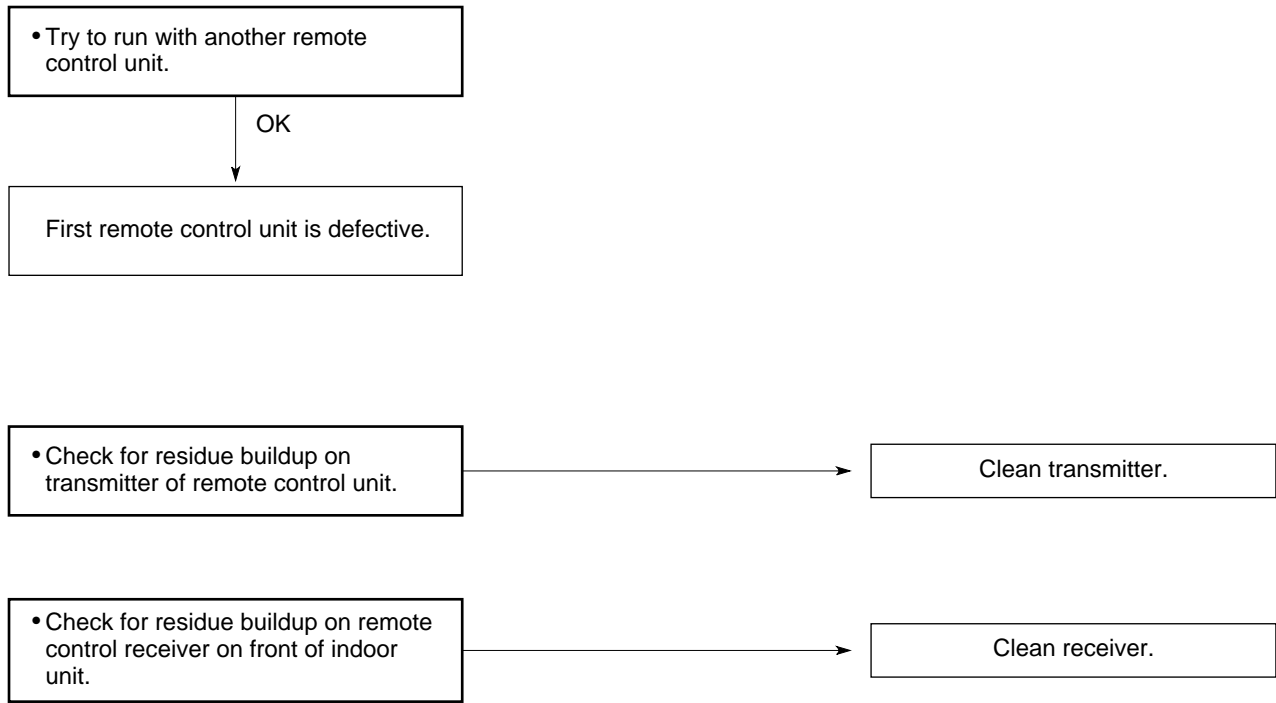

D. Check fuse on the indoor PCB Ass'y.

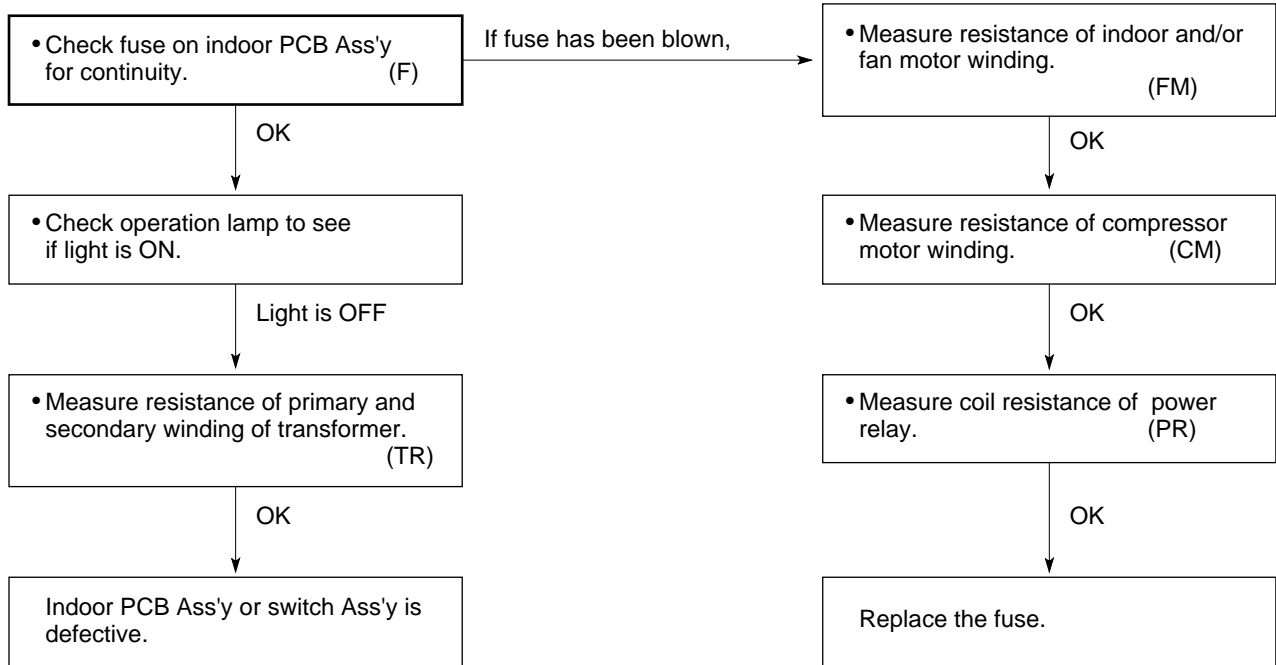

E. Check TIMER on the remote control unit.



9-2-3. Only outdoor unit does not run.

A. Check setting temperature.

COOL

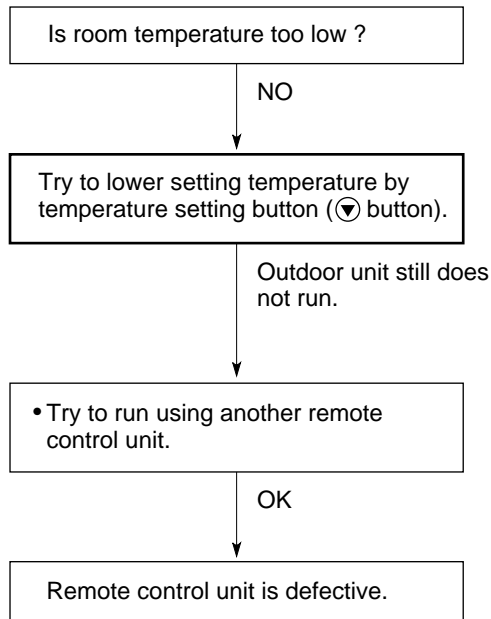

HEAT

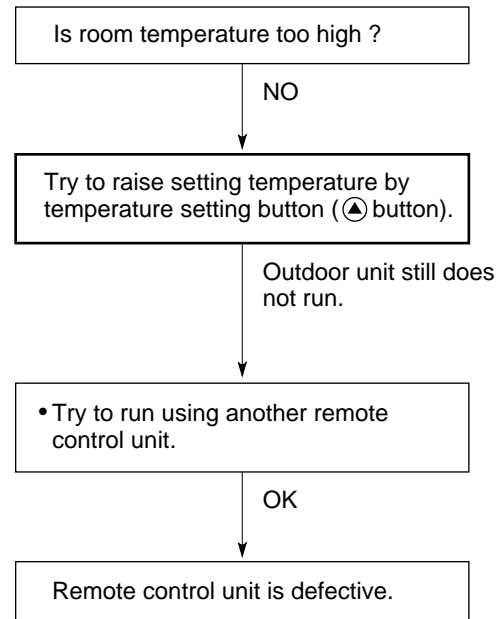

B. Check PCB Ass'y in either indoor or outdoor unit.

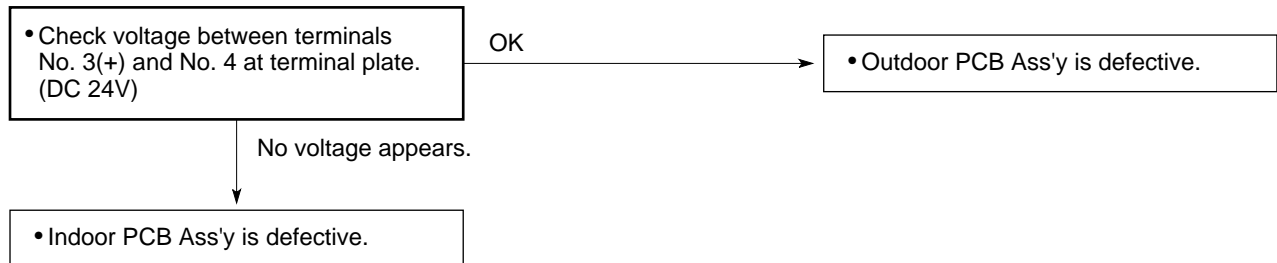

9-2-4. Only indoor unit does not run.

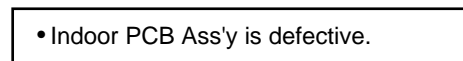

9-3. Some part of air conditioner does not operate.

9-3-1. Only indoor fan does not run.

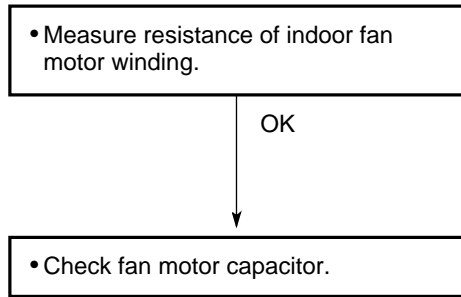
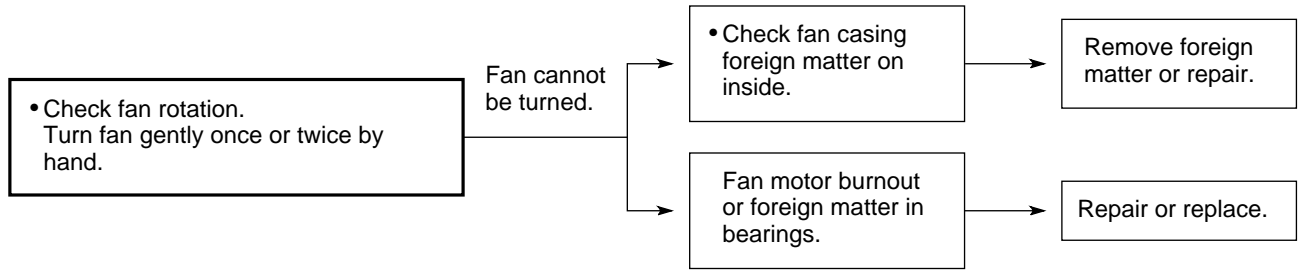

9-3-2. Only flap motor does not run.

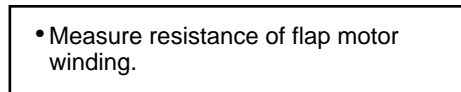

9-3-4. Only outdoor fan does not run.

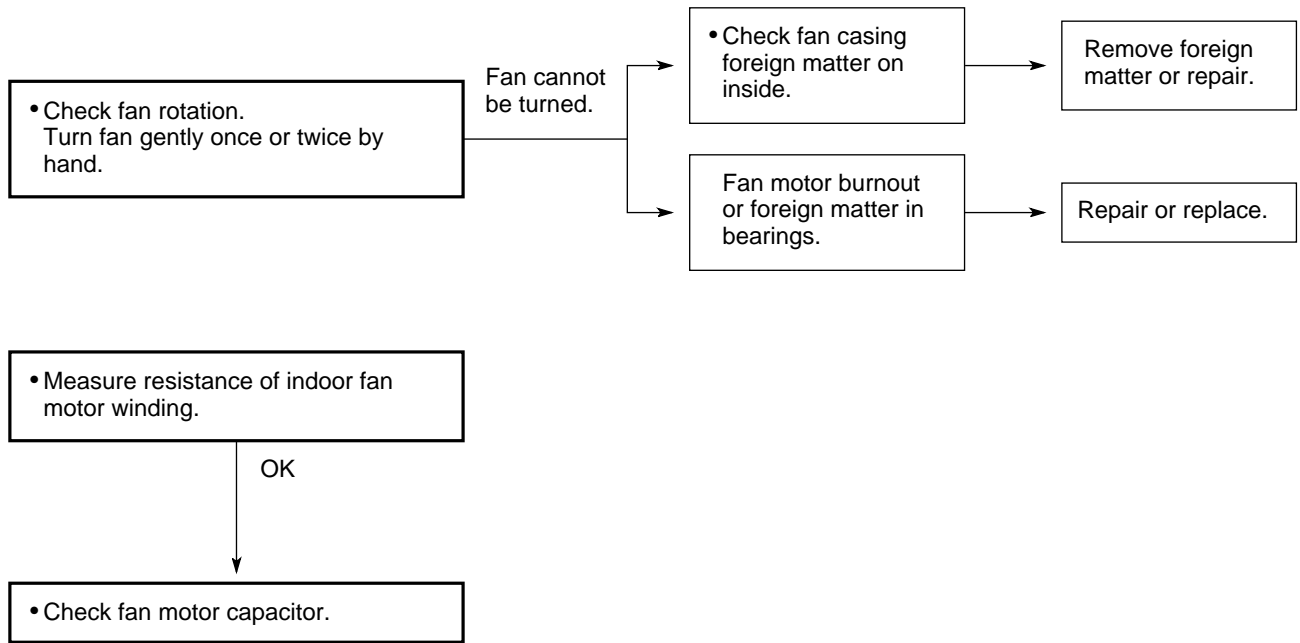

9-3-5. Only compressor does not run.

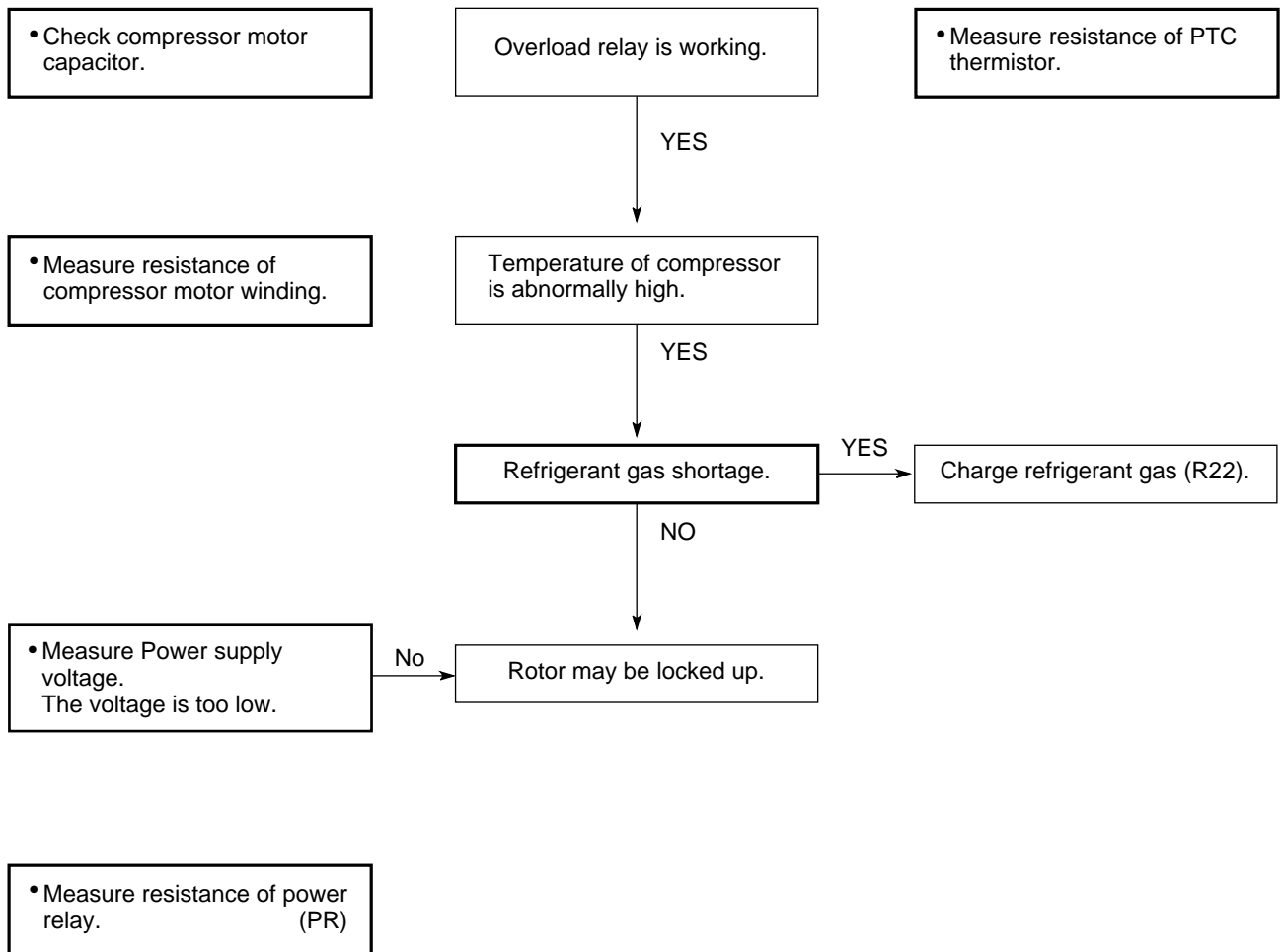

9-4. Air conditioner operates, but abnormalities are observed.

9-4-1. Operation does not switch from HEAT to COOL (or COOL to HEAT).

• Remote control unit may be defective.

Receiver in lamp Ass'y may be defective.

• Measure resistance of 4-way valve's winding.

COOL → HEAT

• Check voltage between terminals No. 3(+) and No. 5 at terminal plate. (DC 24V)

OK

Outdoor PCB Ass'y is defective.

No voltage appears.

• Indoor PCB Ass'y is defective.

HEAT → COOL

• Check voltage between terminals No. 3(+) and No. 5 at terminal plate. (0V)

9-4-2. Poor cooling or heating.

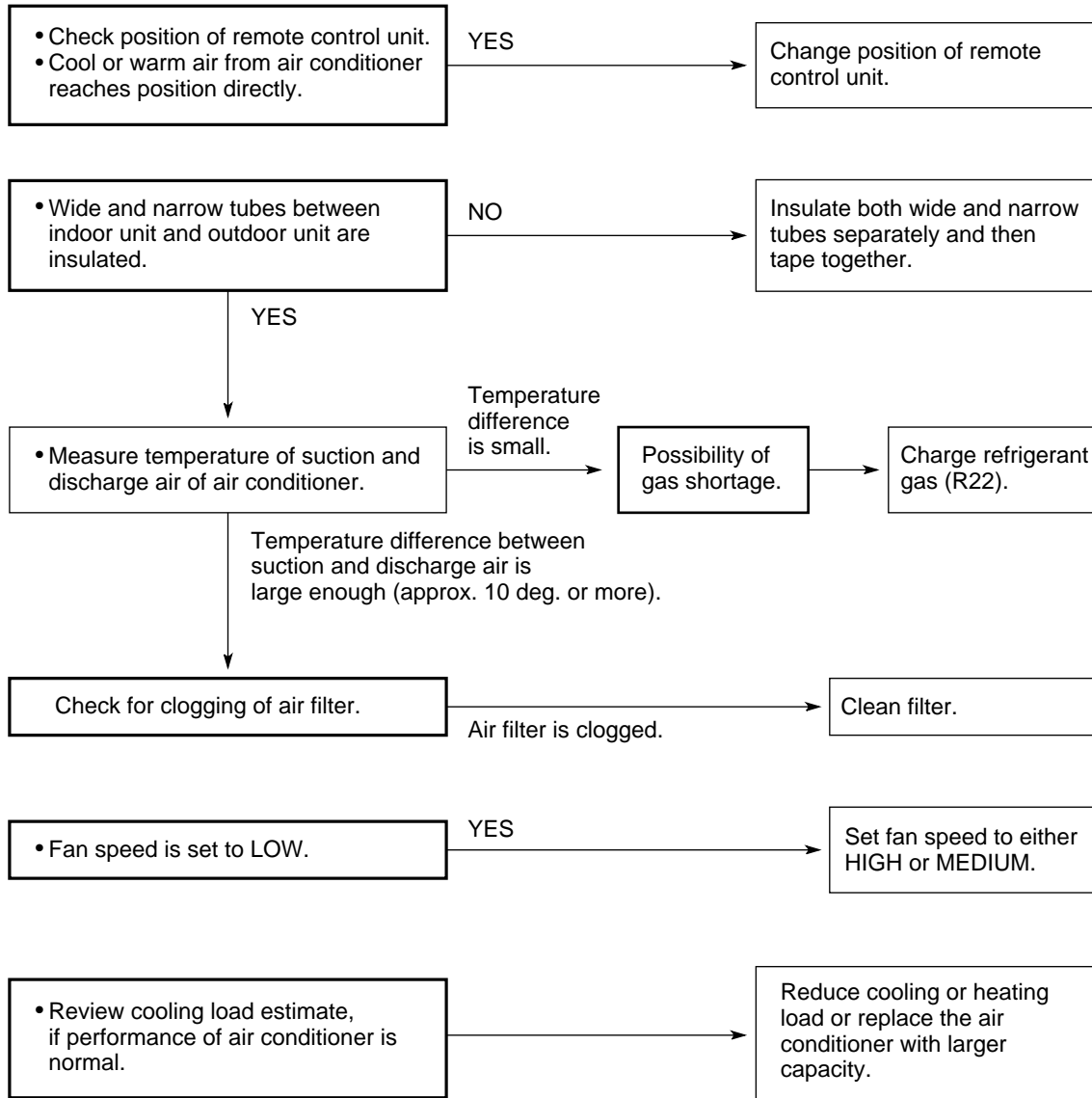

9-4-3. Excessive cooling or heating.

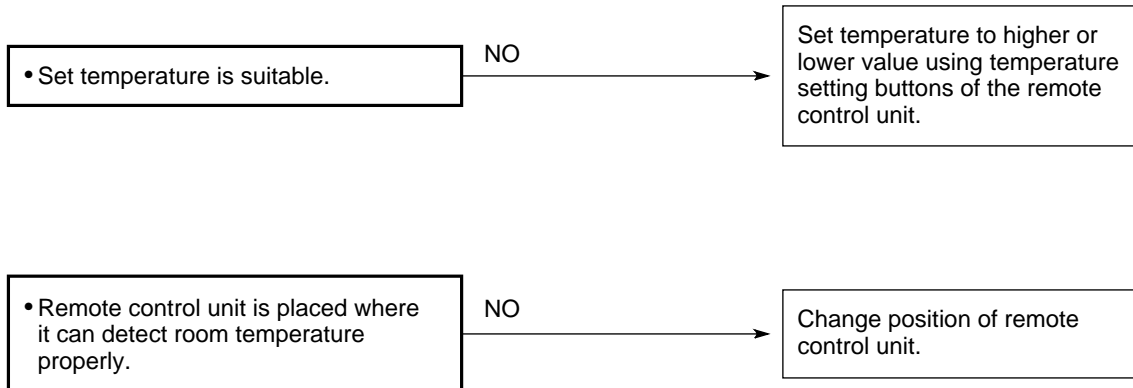

9-5. If a sensor is defective.

9-5-1. Indoor coil temp. thermistor (TH1) is defective.

A. Open

When thermistor opens, the air conditioner will be in the following conditions as the controller tries to detect extremely low indoor coil temperature.

In Cooling mode: Function of freeze prevention continues to work. That is, the controller turns both compressor and outdoor fan motor periodically ON and OFF for several minutes. (Refer to "8-3. Freeze Prevention")

B. Short

When thermistor is short, the air conditioner will be in the following conditions as the controller tries to detect extremely high indoor coil temperature.

In Cooling mode: Function of freeze prevention will not work even when the frost builds up on indoor heat exchanger coil

9-5-2. Room temp. thermistor (TH2) is defective.

A. Open

When thermistor opens, the air conditioner will be in the following conditions as the controller tries to detect extremely low room temperature.

In Cooling mode: The air conditioner soon stops and will not start again. (Thermo.OFF) Neither outdoor fan nor compressor runs.

B. Short

When thermistor is short, the air conditioner will be in the following conditions as the controller tries to detect extremely high room temperature.

In Cooling mode: The air conditioner continues to operate (Thermo.ON). Both the outdoor fan and compressor do not stop. As a result, the room becomes too cold.

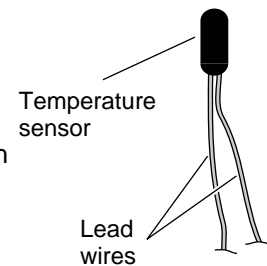

NOTE

Definition of Open or Short Circuit of Sensor (Thermistor)

Thermistor Structure

Open ... A lead wire is broken or disconnected or the circuit inside the temperature sensor is open .

Short ... The protective cover of a lead wire has been damaged, and the exposed wire is touching another metal part, or both lead wires have become exposed and are touching each other. Alternatively, the circuit inside the temperature sensor is closed.

10. CHECKING ELECTRICAL COMPONENTS

10-1. Measurement of Insulation Resistance

- The insulation is in good condition if the resistance exceeds $2M\Omega$.

10-1-1. Power Supply Wires

Clamp the ground wire of the power supply wires with the lead clip of the insulation resistance tester and measure the resistance by placing a probe on either of the power wires. (Fig. 1)

Then measure the resistance between the ground wire and the other power wire. (Fig. 1)

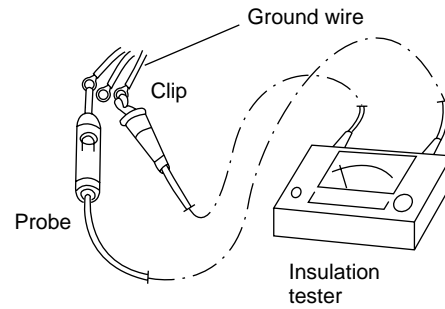

Fig. 1

10-1-2. Indoor Unit

Clamp an aluminum plate fin or copper tube with the lead clip of the insulation resistance tester and measure the resistance by placing a probe on each terminal screw on the terminal plate. (Fig. 2)

Note that the ground line terminal should be skipped for the check.

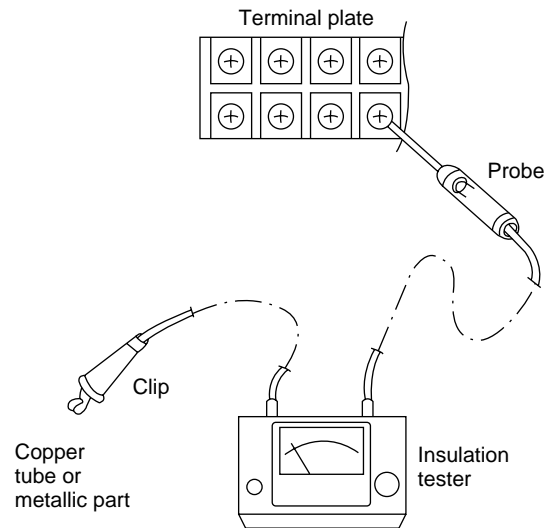

Fig. 2

10-1-3. Outdoor Unit

Clamp a metallic part of the unit with the lead clip of the insulation resistance tester and measure the resistance by placing a probe on each terminal screw where power supply lines are connected on the terminal plate. (Fig. 2)

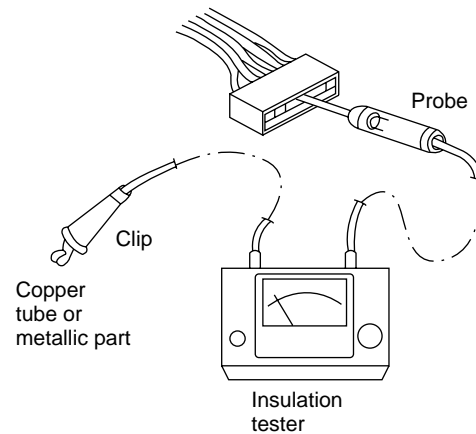

Fig. 3

10-1-4. Measurement of Insulation Resistance for Electrical Parts

Disconnect the lead wires of the desired electric part from terminal plate, capacitor, etc. Similarly disconnect the connector. Then measure the insulation resistance. (Figs. 3 and 4)

NOTE

Refer to Electric Wiring Diagram.

If the probe cannot enter the poles because the hole is too narrow then use a probe with a thinner pin.

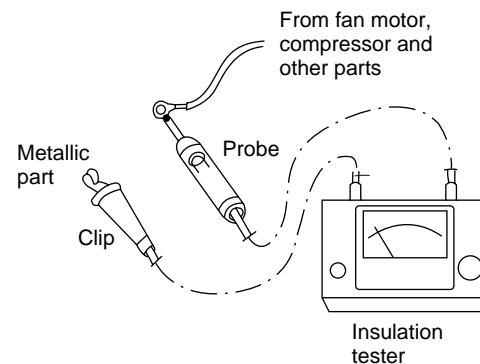

Fig. 4

10-2. Checking Continuity of Fuse on PCB Ass'y

- Remove the PCB Ass'y from the electrical component box. Then pull out the fuse from the PCB Ass'y. (Fig. 5)
- Check for continuity using a multimeter as shown in Fig. 6.

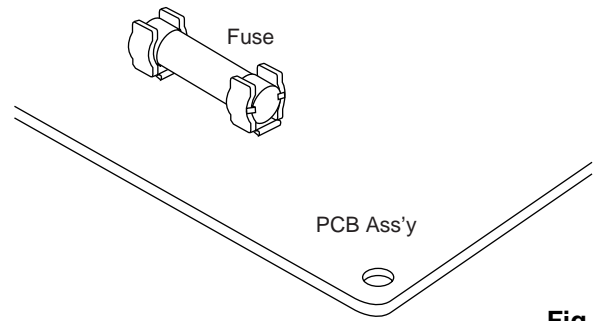

Fig. 5

10-3. Checking Motor Capacitor

Remove the lead wires from the capacitor terminals, and then place a probe on the capacitor terminals as shown in Fig. 7. Observe the deflection of the pointer, setting the resistance measuring range of the multimeter to the maximum value.

The capacitor is "good" if the pointer bounces to a great extent and then gradually returns to its original position.

The range of deflection and deflection time differ according to the capacity of the capacitor.

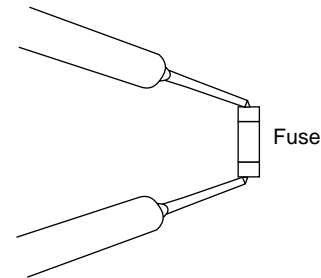

Fig. 6

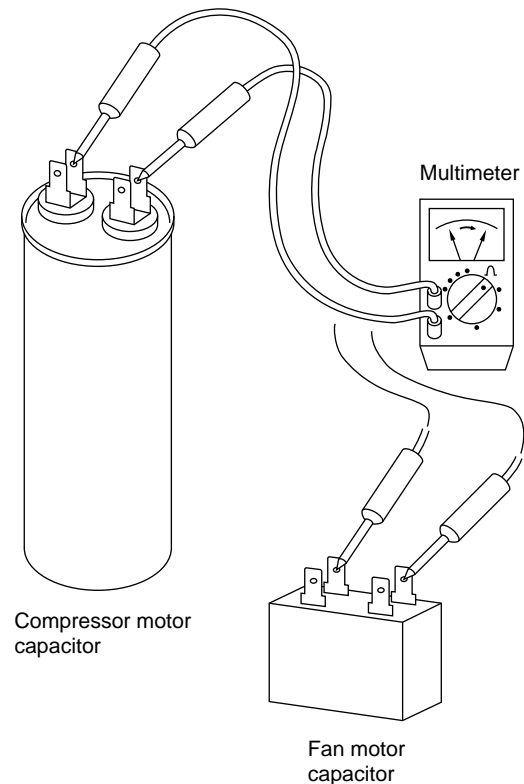
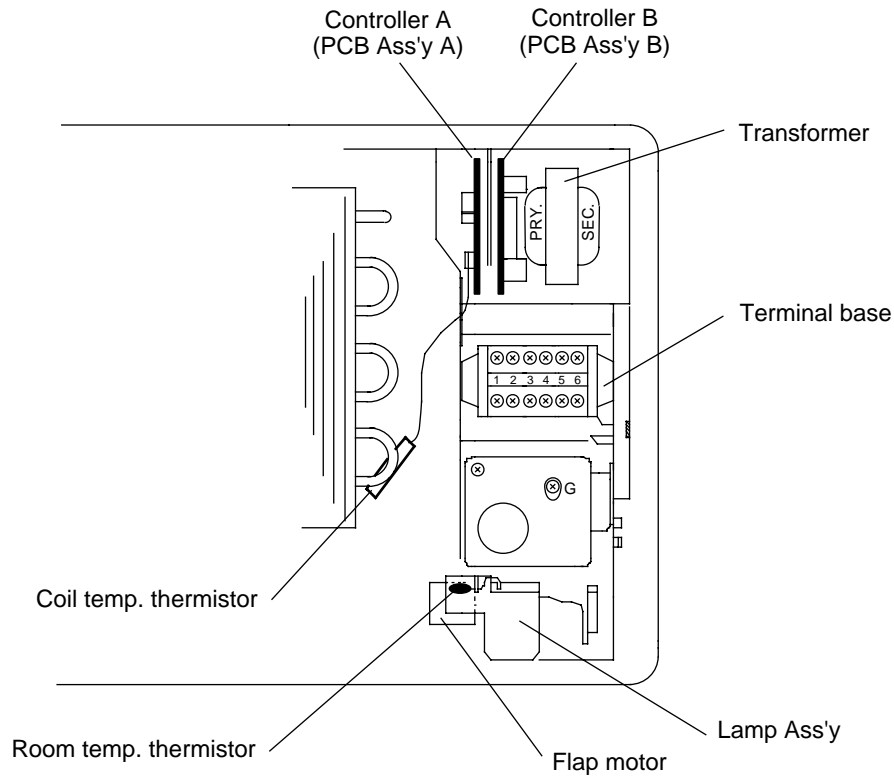

Fig. 7

11. ARRANGEMENT OF ELECTRICAL COMPONENT

Indoor Unit **KHS0951 / KHS1251**



Indoor Unit **KHS1852**

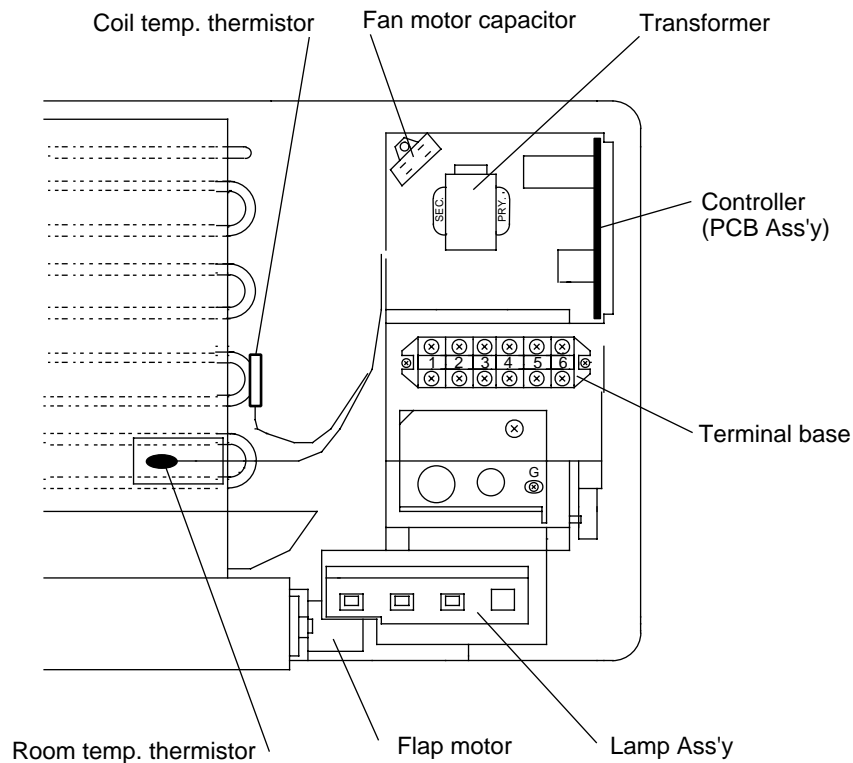

● **Electric Parts**

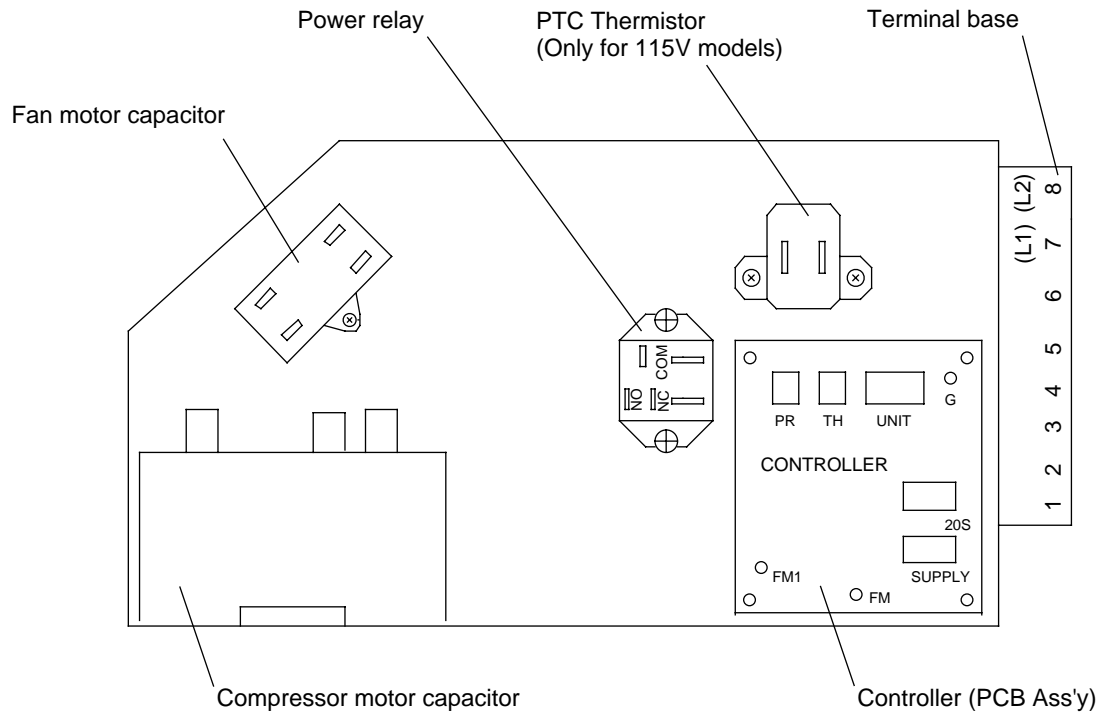

● **Parts Layout in Unit**

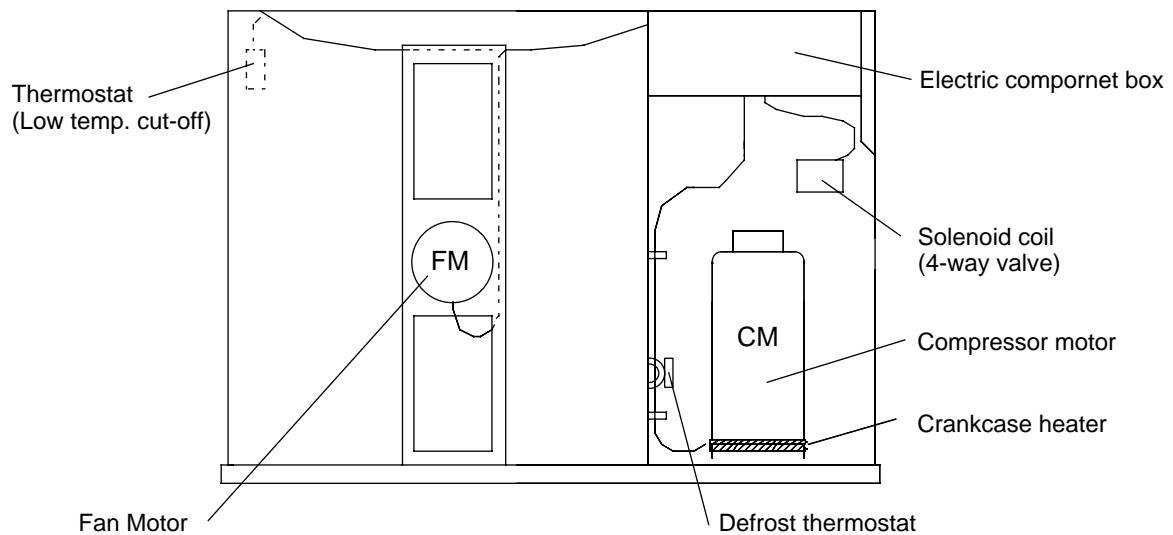

APPENDIX INSTRUCTION MANUAL

KHS0951 + CH0951

KHS1251 + CH1251

KHS1852 + CH1852

Features

This air conditioner is equipped with cooling, heating and drying functions. Details on these functions are provided below; refer to these descriptions when using the air conditioner.

- **Microprocessor Controlled Operation**
The interior compartment of the remote control unit contains several features to facilitate automatic operation, easy logically displayed for easy use.
 - **Simple One-touch Wireless Remote Control**
The remote control unit has several features to facilitate automatic operation.
 - **12-Hour ON or OFF Timer**
This timer can be set to automatically turn the unit on or off at any time within a 12 hour period.
 - **1-Hour OFF Timer**
This timer can be set to automatically turn off the unit at any time after one hour.
 - **Night Setback**
Pressing this button changes the setting of the room temperature thermostat, allowing you to set the temperature at whatever level that you find comfortable.
 - **Automatic and 3-step Fan Speed**
Auto/High/Medium/Low
 - **Air Sweep Control**
This function moves a flap up and down in the air outlet, directing air in a sweeping motion around the room and providing comfort in every corner.
 - **Automatic Switching between Cooling and Heating**
This unit automatically switches between cooling operation and heating operation according to the difference between the room temperature and the temperature setting.
 - **Hot Start Heating System**
Right from the start, the air is warm and comfortable. This system prevents any cold blasts at the beginning while the heat pump is warming up, or even defrosting.
 - **Automatic Restart Function for Power Failure**
Even when power failure occurs, preset programmed operation can be reactivated once power resumes.
 - **Anti-Mold Filter**
This unit is equipped with an anti-mold filter that inhibits the growth of mold and bacteria.
-
- **Optional Air Clean Filter**
An air filter that uses activated charcoal to eliminate unpleasant odors and clean the air is available (sold separately).



CAUTION

If the outdoor temperature is extremely low, it is recommended to use another heating appliance:

When the outdoor temperature falls to around 5°F, the compressor stops. However, indoor fan continues to operate even after the compressor has been stopped. In this case, to prevent room from freezing, use another heating appliance.

Contents

	Page
Features	2
Product Information	3
Alert Symbols	3
Installation Location	4
Electrical Requirements	4
Safety Instructions	4
Names of Parts	5
Using the Remote Control Unit	10
Operation with the Remote Control Unit.....	12
1. Automatic Operation	12
2. Manual Operation	14
3. Adjusting the Fan Speed.....	15
4. Night Setback Mode	16
Special Remarks	18
Using the 12-Hour ON and OFF Timer	19
Using the 1-Hour OFF Timer.....	20
Adjusting the Airflow Direction	21
Operation without the Remote Control Unit	22
Care and Cleaning.....	22
Tips for Energy Saving	25
Troubleshooting.....	26
Operating Range	26

Product Information

If you have problems or questions concerning your Air Conditioner, you will need the following information. Model and serial numbers are on the nameplate on the bottom of the cabinet.

Model No. _____ Serial No. _____

Date of purchase _____

Dealer's address _____

Phone number _____

Alert Symbols

The following symbols used in this manual, alert you to potentially dangerous conditions to users, service personnel or the appliance:



WARNING

This symbol refers to a hazard or unsafe practice which can result in severe personal injury or death.



CAUTION

This symbol refers to a hazard or unsafe practice which can result in personal injury or product or property damage.

Installation Location

- We recommend that this air conditioner be installed properly by qualified installation technicians in accordance with the Installation Instructions provided with the unit.
- Before installation, check that the voltage of the electric supply in your home or office is the same as the voltage shown on the nameplate.



WARNING

- Do not install this air conditioner where there are fumes or flammable gases, or in an extremely humid space such as a greenhouse.
- Do not install the air conditioner where excessively high heat-generating objects are placed.

Avoid: To protect the air conditioner from heavy corrosion, avoid installing the outdoor unit where salty sea water can splash directly onto it or in sulphurous air near a spa.

Electrical Requirements

1. All wiring must conform to the local electrical codes. Consult your dealer or a qualified electrician for details.
2. Each unit must be properly grounded with a ground (or earth) wire or through the supply wiring.
3. Wiring must be done by a qualified electrician.

Safety Instructions

- Read this Instruction Manual carefully before using this air conditioner. If you still have any difficulties or problems, consult your dealer for help.
- This air conditioner is designed to give you comfortable room conditions. Use this only for its intended purpose as described in this Instruction Manual.



WARNING

- Never use or store gasoline or other flammable vapor or liquid near the air conditioner – it is very dangerous.
- This air conditioner has no ventilator for intaking fresh air from outdoors. You must open doors or windows frequently when you use gas or oil heating appliances in the same room, which consume a lot of oxygen from the air. Otherwise there is a risk of suffocation in an extreme case.



CAUTION

- Do not turn the air conditioner on and off from the power mains switch. Use the ON/OFF operation button.
- Do not stick anything into the air outlet of the outdoor unit. This is dangerous because the fan is rotating at high speed.
- Do not let children play with the air conditioner.
- Do not cool the room too much if babies or invalids are present.

Names of Parts

INDOOR UNIT

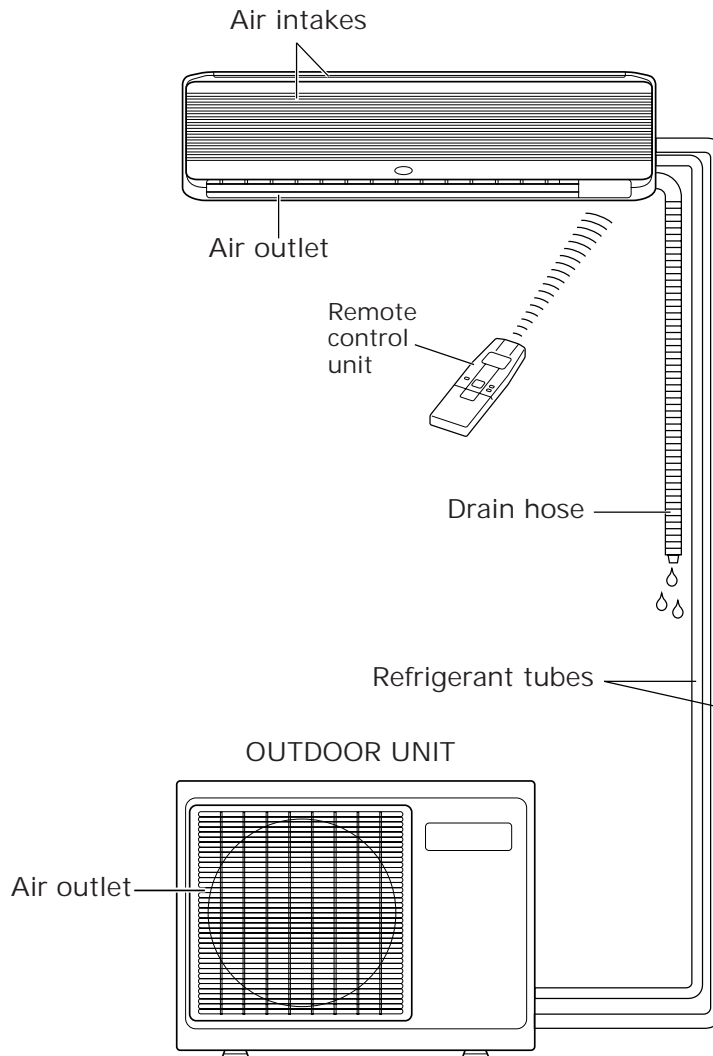

NOTE

This illustration is based on the external appearance of a standard model. Consequently, the shape may differ from that of the air conditioner which you have selected.

This air conditioner consists of an indoor unit and an outdoor unit. You can control the air conditioner with the remote control unit.

Air Intakes	Air from the room is drawn into these sections and passes through air filters which remove dust.
Air Outlet	Air is blown out of the air conditioner through the air outlet.
Remote Control Unit	The wireless remote control unit controls power on/off, operation mode selection, temperature, fan speed, timer setting, night setback and air sweeping.
Refrigerant Tubes	The indoor and outdoor units are connected by copper tubes through which refrigerant gas flows.
Drain Hose	Moisture in the room condenses and drains off through this hose.
Outdoor (Condensing) Unit	The outdoor unit contains the compressor, fan motor, heat exchanger coil, and other electrical components.

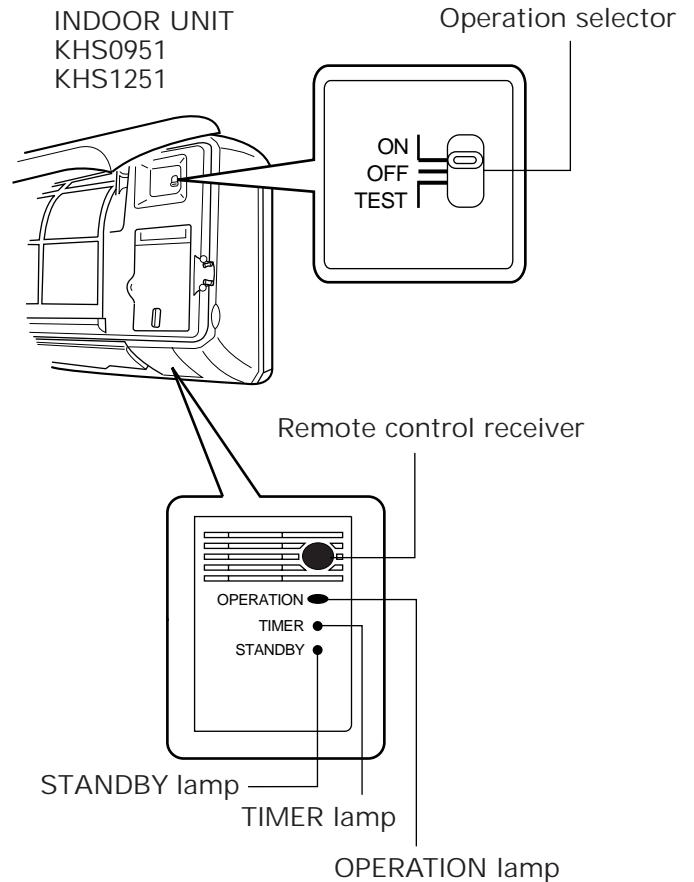
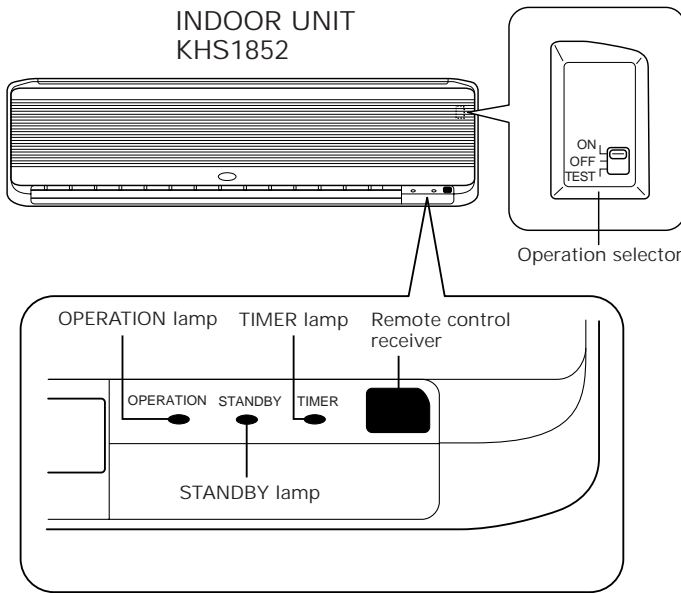

Unit Display and Operation Selector



IMPORTANT

Avoid using radio equipment such as mobile phones near (within 1 m of) the indoor unit. Some radio equipment may cause the unit to malfunction.

If the trouble occurs, disconnect power and restart the air conditioner after a few minutes.

Remote control receiver	This section picks up infrared signals from the remote control unit (transmitter).
Operation selector ON position	This position is for operating the air conditioner with the wireless remote control unit. Set the selector normally in this position.
OFF position	Switch the selector to the OFF position if you are not going to use the air conditioner for a few days or longer.
 WARNING	The OFF position does not disconnect the power. Use the main power switch to turn off power completely.
TEST position	This position is used only when servicing the air conditioner.
 CAUTION	Do not set at the TEST position for normal operation.
OPERATION lamp	This lamp lights when the system is in the continuous HEAT, DRY and COOL mode.
TIMER lamp	This lamp lights when the system is being controlled by the timer.
STANDBY lamp	This lamp lights during the warm up period for heating and when the system is defrosting.

Remote Control Unit (Display)

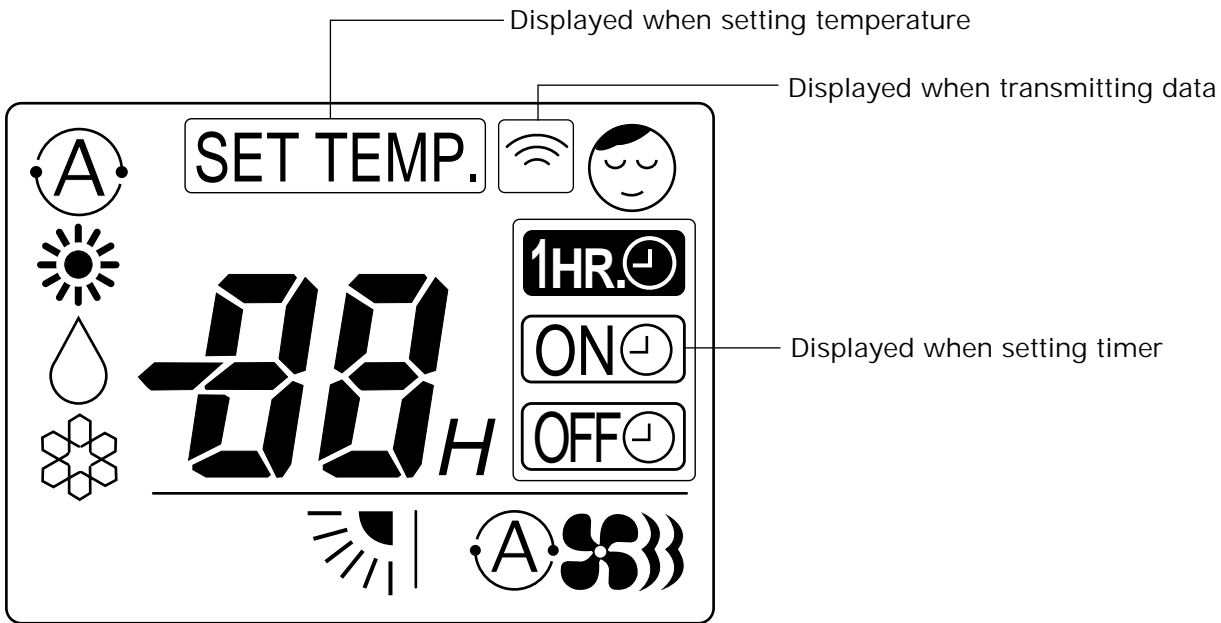

Symbols

(1) Operation mode

AUTO	
HEAT	
MILD DRY	
COOL	

(2) Fan speed

AUTO	
HIGH	
MEDIUM	
LOW	

(3) Temperature setting

60 – 88 °F
 When set to 82 °F
 Current temperature indication

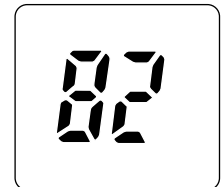

(4) Timer

12-hour ON Timer

12-hour OFF Timer

1-hour OFF Timer

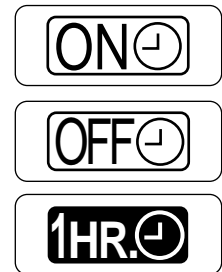

(5) NIGHT SETBACK



(6) Confirmation of transmission



(7) Flap

Angle indication



Sweep indication





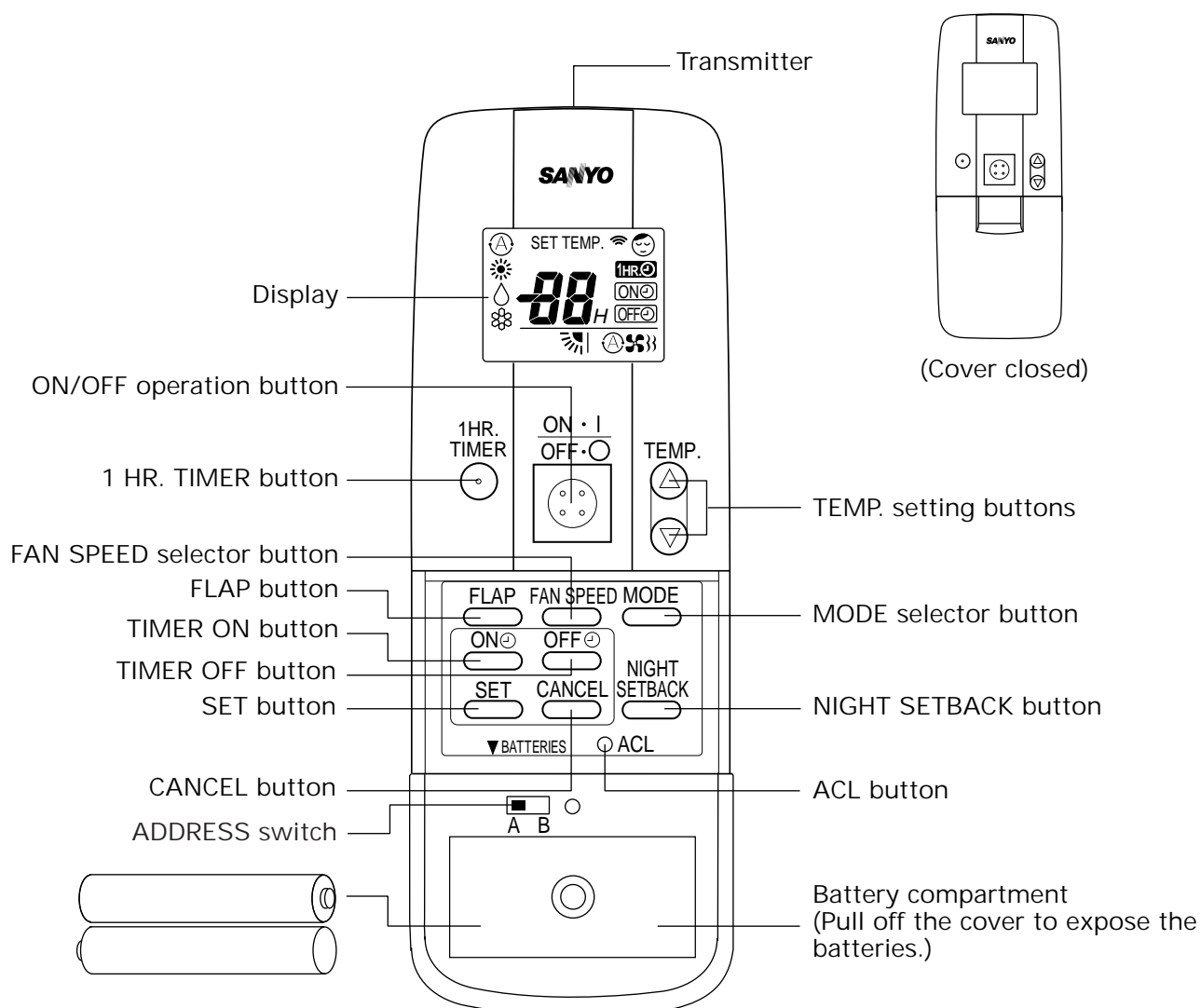









Remote Control Unit



NOTE The illustration above pictures the remote control unit after the cover has been lowered and removed.

Transmitter	When you press the buttons on the remote control unit, the mark appears in the display and the setting changes are transmitted to the receiver in the air conditioner.
Display	Information on the operating status is displayed while the remote control unit is switched on. If the unit is turned off, only the mode that was set previously is still displayed.
NIGHT SETBACK button	For details, see "Night Setback Mode". When you press this button in the DRY, COOL or HEAT mode, the mark appears in the display, and the remote control unit automatically adjusts the set temperature to save energy.
TEMP. setting buttons	Press the button to increase the temperature setting. Press the button to reduce the temperature setting.
ON/OFF operation button	This button is for turning the air conditioner on and off.
TIMER ON button	: The air conditioner starts at the set time.
TIMER OFF button	: The air conditioner stops at the set time.

Remote Control Unit (continued)

<p>MODE selector button Green or red (AUTO)</p> <p>Red (HEAT) Orange (DRY) Green (COOL)</p>	<p>Use this button to select the AUTO, HEAT, DRY and COOL mode.</p> <p> : When this setting is selected, the air conditioner calculates the difference between the thermostat setting and the room temperature and automatically switches to the "COOL" or "HEAT" mode as appropriate.</p> <p> : The air conditioner makes the room warmer.</p> <p> : The air conditioner reduces the humidity in the room.</p> <p> : The air conditioner makes the room cooler.</p>
<p>FLAP button</p> <p style="text-align: center;">NOTE</p>	<p>Press this button either to select to set the airflow direction to one of the six possible positions manually, or to select the sweep function, which moves the flap up and down automatically.</p> <p> : The airflow direction can be set manually. (six positions)</p> <p> : The flap moves up and down automatically.</p> <p>To switch to the sweep function () when in the manual () mode, hold down the FLAP button.</p>
<p>FAN SPEED selector button</p>	<p> : The air conditioner automatically decides the fan speed.</p> <p> : High fan speed</p> <p> : Medium fan speed</p> <p> : Low fan speed</p>
<p>1 HR. TIMER button (1-hour off timer)</p>	<p> : When you press this button, regardless of whether the unit is operating or stopped, the unit operates for one hour and then shuts down.</p>
<p>ACL button (All clear)</p>	<p>Puts the remote control unit into pre-operation status. Always press this button after replacing the batteries.</p>
<p>SET button</p>	<p>After using the TIMER ON button or TIMER OFF button to set the timer, press this button to activate the new setting.</p>
<p>CANCEL button</p>	<p>Press this button to cancel the current timer setting.</p>
<p>ADDRESS switch</p>	<p>The address switch changes to prevent mixing of signals from remote control units when two Sanyo air conditioners are installed next to each other. Normally, the address switch is set to A. When switching the address, the remote control unit must be changed to B. For more information, please contact the dealer where you made the purchase.</p>

Using the Remote Control Unit

How to Install Batteries

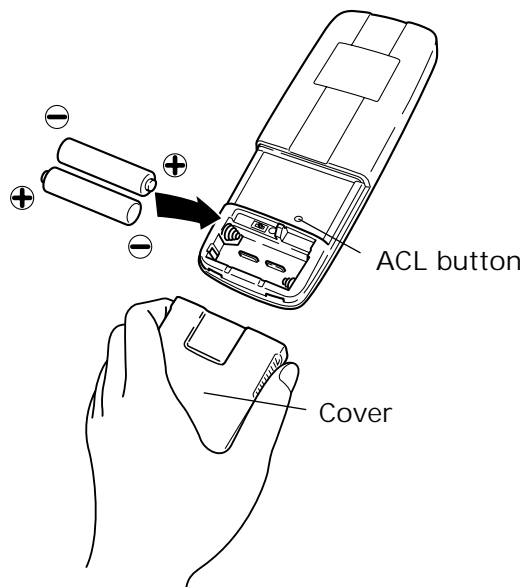

1. Slide the cover in the direction indicated by the arrow and remove it.
2. Install two AAA alkaline batteries. Make sure the batteries point in the direction marked in the battery compartment.
3. Use a thin object such as the tip of a pen to press the ACL button.

NOTE

- The batteries last about six months, depending on how much you use the remote control unit. Replace the batteries when the remote control unit's display fails to light, or when the remote control cannot be used to change the air conditioner's settings.
- Use two fresh leak-proof type-AAA alkaline batteries.
- In replacing batteries, follow the instructions as mentioned in the sub-section "How to Install Batteries".
- If you do not use the remote control unit more than 1 month, take out the batteries.

How to Use the Remote Control Unit

When using the remote control unit, always point the unit's transmitter head directly at the air conditioner's receiver.

Air conditioner
(Indoor unit)



Receiver

Remote control
unit

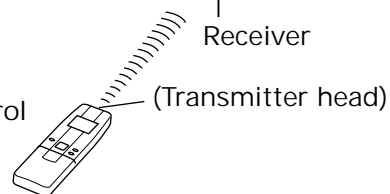

(Transmitter head)

Remote Control Unit Installation Position

The remote control unit may be operated either from a non-fixed position or from a wall-mounted position. To ensure that the air conditioner operates correctly, **DO NOT** install the remote control unit in the following places:

DO NOT

- In direct sunlight
- Behind a curtain or other places where it is covered
- More than 26 feet (8 m) away from the air conditioner
- In the path of the air conditioner's airstream
- Where it may become extremely hot or cold
- Where it may be subject to electrical or magnetic noise
- Where there is an obstacle between the remote control unit and air conditioner (since a check signal is sent from the remote control unit every 5 minutes)

Using the Remote Control Unit (continued)

Mounting the Remote Control Unit

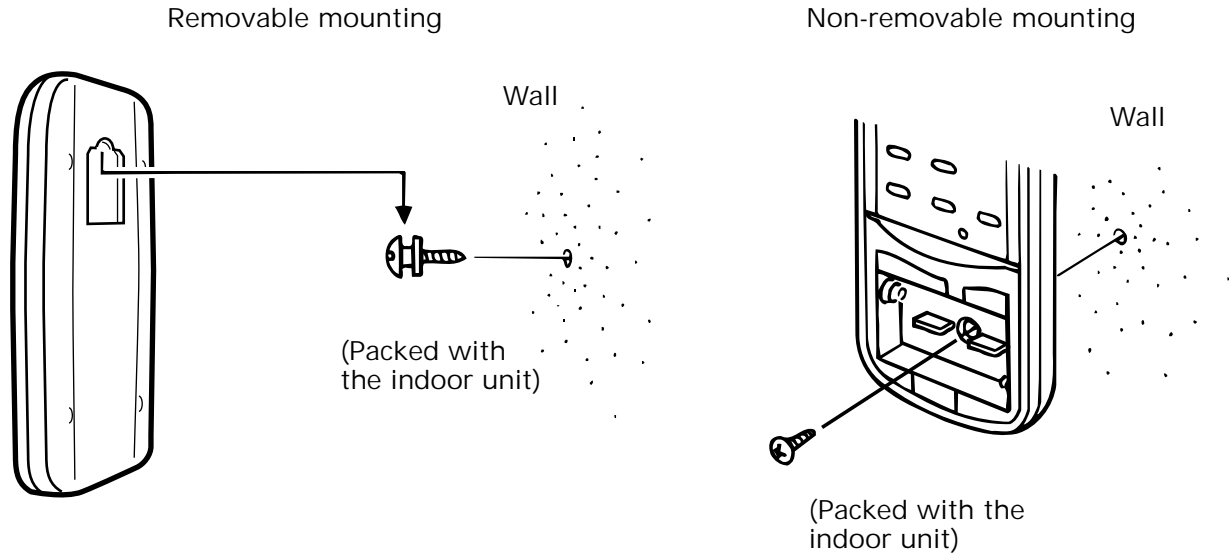

Mounting on a wall

A. Removable mounting

- 1) Momentarily hold the remote control unit at the desired mounting position.
- 2) Confirm that the air conditioner responds correctly when you press keys on the remote control from that position.
- 3) After confirming correct operation, use a screwdriver to screw the mounting screw into the wall.
- 4) Hang the remote control unit from the mounting screw.

B. Non-removable mounting

- 1) Momentarily hold the remote control unit at the desired mounting position.
- 2) Confirm that the air conditioner responds correctly when you press keys on the remote control from that position.
- 3) After confirming correct operation, use a screwdriver to screw the mounting screw into the wall.
- 4) Remove the batteries of the remote control unit.
- 5) Use a screwdriver to screw the remote control unit securing screw into the wall through the hole in the battery compartment.
- 6) Replace the batteries.
- 7) Again confirm that the remote control unit operates correctly.

Operation with the Remote Control Unit

1. Automatic Operation

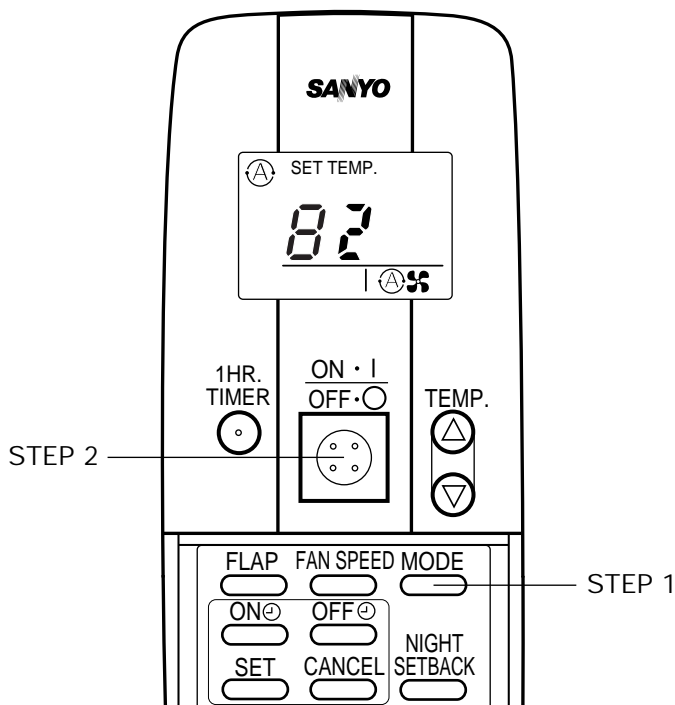

NOTE

Check that the circuit breaker on the power panel is turned on and that the operation selector of the indoor unit is in the ON position.

Once the  mode is selected and the unit is preset by following the steps below, you can have the air conditioner automatically bring the room to the desired temperature simply by pressing the ON/OFF operation button.

STEP 1	Press the MODE selector to select  .
STEP 2	Press the ON/OFF operation button.

To stop the air conditioner, press the ON/OFF operation button again.

NOTE

- To change the temperature setting, press the temperature setting buttons and change the setting to the desired temperature.
- The temperature setting changes by two degrees each time one of the TEMP. buttons is pressed.

Operation with the Remote Control Unit (continued)

Press TEMP. to change the temperature setting.

To raise the temperature setting

TEMP.

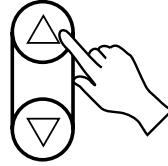

To lower the temperature setting

- Although the fan speed is set automatically, you can change the fan speed by pressing the FAN SPEED selector button.



To stop the air conditioner, press the ON/OFF operation button again.

Operation with the Remote Control Unit (continued)

2. Manual Operation

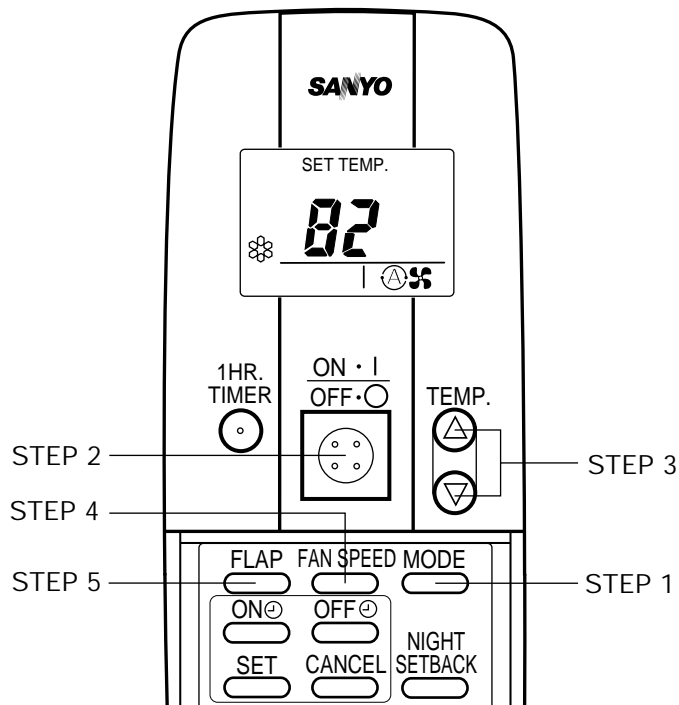

NOTE

Check that the circuit breaker on the power panel is turned on and that the operation selector of the indoor unit is in the ON position.

If the automatic operation settings of the unit do not meet your needs, press the setting buttons as described below and change the settings as desired.

STEP 1	Press the MODE selector button and select the desired mode. For heating operation → ☀ For dehumidifying operation → 💧 For cooling operation → ❄
STEP 2	To start the air conditioner, press the ON/OFF operation button.
STEP 3	Press the TEMP. setting buttons to change the temperature setting to the desired temperature. Adjustable temperature range: 88 °F max. 60 °F min.
STEP 4	Set the FAN SPEED selector button to the setting you want.
NOTE	If the fan speed is set to Ⓐ❄ (Automatic), the fan speed switches automatically, according to the difference between the actual room temperature and the temperature setting.
STEP 5	Press the FLAP button and set the airflow direction as desired. (Refer to "Adjusting the Airflow Direction" on page 21.)

To stop the air conditioner, press the ON/OFF operation button again.

Operation with the Remote Control Unit (continued)

NOTE

- This appliance has a built-in 5-minute time delay circuit to ensure reliable operation. When the operation button is pressed, the compressor will start running within three minutes. In the event of power failure, the unit will stop. When the power is restored, the unit will restart automatically after five minutes.

3. Adjusting the Fan Speed

A. Automatic

Simply set the FAN SPEED selector button to the  position.

A microcomputer in the air conditioner automatically controls the fan speed when the  mode is selected. When the air conditioner starts operating, the difference between the room temperature and the set temperature is detected by the microcomputer which then automatically switches the fan speed to the most suitable level.



Cooling and DRY mode:

When difference between room temperature and set temperature is	FAN SPEED
4 °F and over	High
Between 4 °F and 2 °F	Medium
Below 2 °F	Low

Heating mode:

When difference between room temperature and set temperature is	FAN SPEED
4 °F and over	High
Below 4 °F	Medium

B. Manual

If you want to adjust fan speed manually during operation, just set the FAN SPEED selector as desired. [ ,  , or ]

Operation with the Remote Control Unit (continued)

4. Night Setback Mode

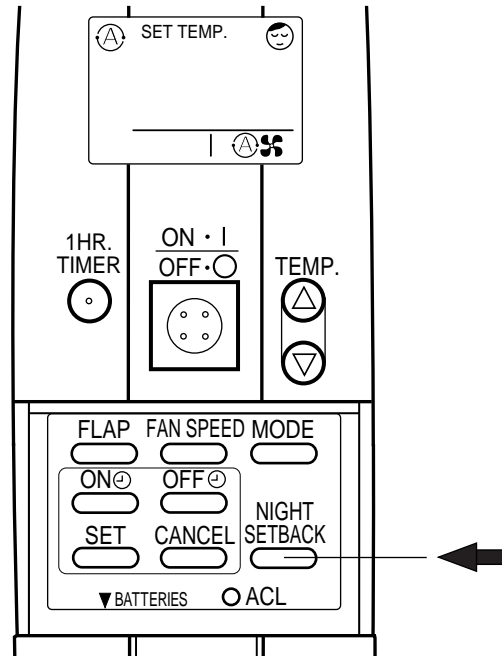

The Night Setback Mode is used for saving energy.

Press the NIGHT SETBACK button while the air conditioner is operating. The ☺ mark appears in the display.

To cancel the night setback function, press the NIGHT SETBACK button again.

Operation with the Remote Control Unit (continued)

A. In Cooling and DRY Mode: (☼ and △)

When the night setback mode is selected, the air conditioner automatically raises the temperature setting 2 °F when 30 minutes have passed after the selection was made, and then another 2 °F after another 30 minutes have passed, regardless of the indoor temperature when night setback was selected. This enables you to save energy without sacrificing comfort. This function is convenient when gentle cooling is needed.

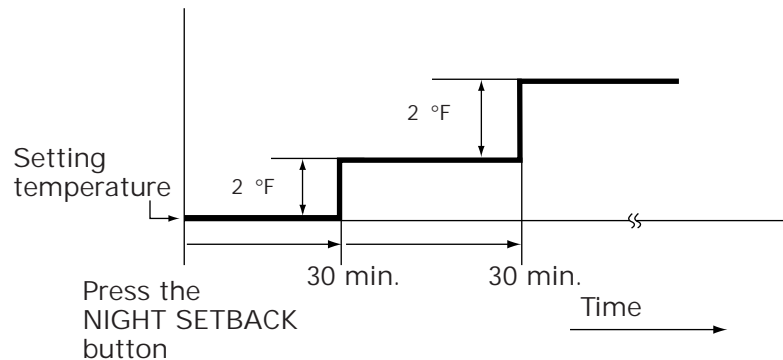

B. In Heating Mode: (☼)

When the night setback mode is selected, the air conditioner automatically lowers the temperature setting 4 °F when 30 minutes have passed after the selection was made, and then another 4 °F after another 30 minutes have passed, regardless of the indoor temperature when night setback was selected. This enables you to save energy without sacrificing comfort. This function is convenient when gentle heating is needed.

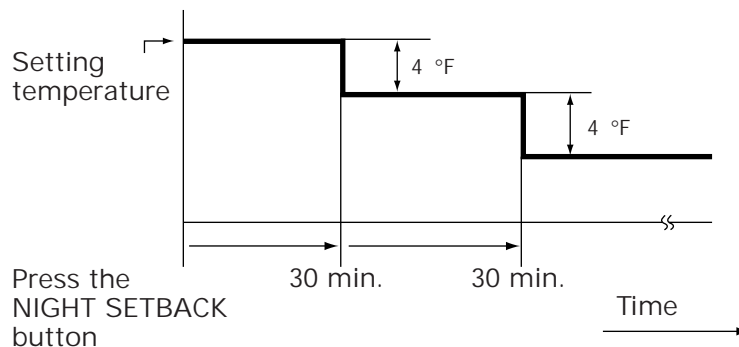

Special Remarks

“DRY” (△) Operation

How it works?

- Once the room temperature reaches the level that was set, the unit repeats the cycle of turning on and off automatically.
- During DRY operation, the fan speed is automatically set to LOW or VERY LOW; the fan speed then switches back and forth between LOW (for 20 seconds) and VERY LOW (for 10 seconds).
- “DRY” operation is not possible if the indoor temperature is 59°F or less.

Heating (☀) Operation

Heating performance

- Because this air conditioner heats a room by drawing in the heat of the outside air (heat pump system), the heating efficiency will fall off when the outdoor temperature is very low. If sufficient heat cannot be obtained with this air conditioner, use another heating appliance in conjunction with it.

Defrosting

- When the outdoor temperature is low, frost or ice may form on the heat exchanger coil, reducing heating performance. When this happens, a microcomputer defrosting system operates. At the same time, the fan on the indoor unit stops and the STANDBY lamp remains lit until defrosting is completed. Heating operation restarts after several minutes. (This interval will vary slightly depending upon the outdoor temperature and the way in which frost forms).

STANDBY lamp

- For several minutes after the start of heating operation, the indoor fan will not start running until the indoor heat exchanger coil has warmed up sufficiently. This is because the COLD DRAFT PREVENTION SYSTEM is operating. During this period, the STANDBY lamp remains lit.

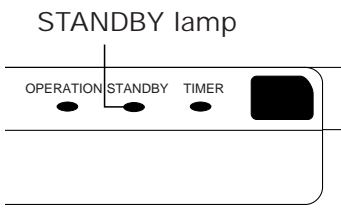

- The STANDBY lamp also remains lit during defrosting or when the compressor has been turned off by the thermostat when the system is in the heating mode.

- Upon completion of defrosting and when the compressor is turned on again, for heating operation, the STANDBY lamp will go off automatically.

Power failure during operation

- In the event of power failure, the unit will stop. When the power is resumed, the unit will restart automatically after five minutes.

Clicking Sound

Clicking sound is heard from the air conditioner

- In heating or cooling operation, any plastic parts may expand or shrink due to a sudden temperature change. In this event, a clicking sound may occur. This is normal, and the sound will soon disappear.

Remote Control Unit

- The remote control unit sends the setting condition to the air conditioner regularly at five minute intervals.

Using the 12-Hour ON and OFF Timer

1. TIMER ON mode (Example)

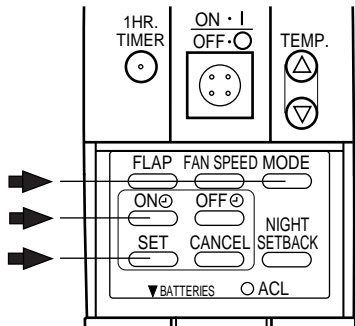

After the length of time set for TIMER ON elapses, the unit begins operating.

The display depicted at left indicates that the air conditioner will begin operating in three hours.

Setting procedure:

STEP 1	Press the MODE selector button and select the desired operation mode. (See "Operation with the Remote Control Unit," page 14.)
STEP 2	Press the TIMER ON button. (For example, to set the timer to turn on the air conditioner after three hours have elapsed, press the TIMER ON button three times.) The time can be set to from one to twelve hours, in one hour steps. → 1 → 2 → 3.....12
STEP 3	Press the SET button.

- The display changes immediately to its status previous to timer setting, but the **ON** indication remains.
- To check the status of the timer while it is counting down, press the SET button.

Cancellation procedure: Press the CANCEL button.

2. TIMER OFF mode (Example)

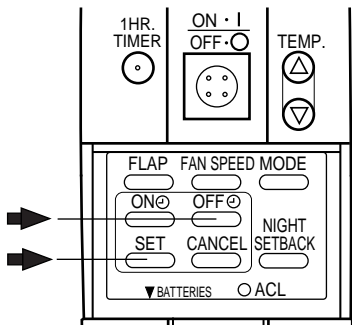

After the length of time set for TIMER OFF elapses, the unit stops operating.

The display depicted at left indicates that the air conditioner will stop operating in five hours.

Setting procedure:

STEP 1	Press the TIMER OFF button. (For example, to set the timer to turn off the air conditioner after five hours have elapsed, press the TIMER OFF button five times.) The time can be set to from one to twelve hours, in one hour steps. → 1 → 2 → 3.....12
STEP 2	Press the SET button.

- The display changes immediately to its status previous to timer setting, but the **OFF** indication remains.
- To check the status of the timer while it is counting down, press the SET button.

Cancellation procedure: Press the CANCEL button.

Using the 1-Hour OFF Timer

1. 1-Hour OFF Timer

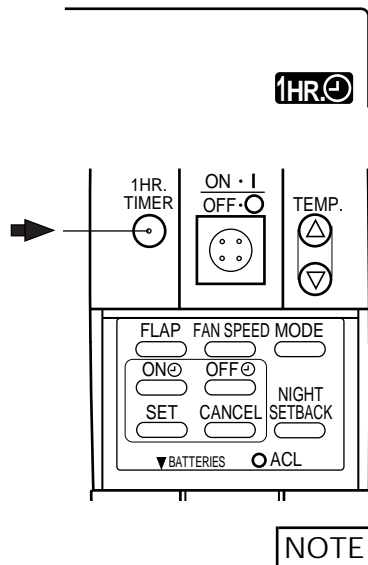

This function causes the unit to operate for one hour and then stop, regardless of whether the unit is on or off when the button is pressed. The **1HR.** indicator in the display indicates that this function is operating.

Setting procedure:

Regardless of whether the unit is operating or stopped, press the 1 HR. TIMER button.

1HR. appears in the display.

Cancellation procedure:

Press the ON/OFF operation button to turn the unit off, wait for the unit to stop operating, and then press the ON/OFF operation button again. The 1-Hour Timer function is now cancelled and the unit operates normally.

- If, while the 1-Hour Timer function is operating, the 1 HR. TIMER button is pressed once to cancel the function and then again, the unit continues to operate for one hour from that point in time and then stops.
- If the 1 HR. TIMER button is pressed while the TIMER OFF function is operating, the OFF Timer is cancelled and the unit stops operating one hour later.

2. Combining the 1-Hour OFF Timer and 12-Hour ON Timer

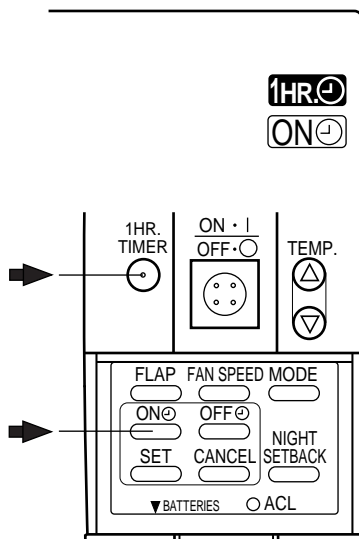

By combining the 1-Hour OFF Timer and 12-Hour ON Timer, it is possible to have the unit operate for just one hour from the present time, and then have it switch on again later at a time specified by you.

(Example) Having the unit operate for just one hour from the present time, and then switch on again three hours from the present time.

Timer setting

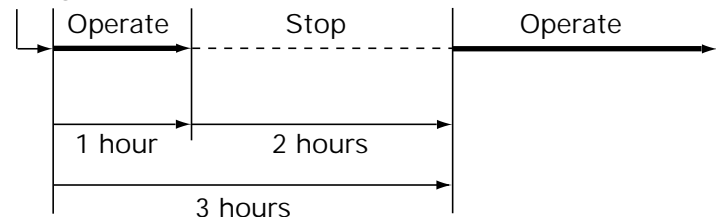

Setting procedure:

STEP 1	Press the 1 HR. TIMER button.
STEP 2	Press the TIMER ON button and use the SET button to set the unit to turn on three hours later.

NOTE

- Set the 1-Hour OFF Timer and the 12-Hour ON Timer simultaneously. Unless you set the 1-Hour OFF Timer and the 12-Hour ON Timer at the same time, the 1-Hour OFF Timer may operate for one hour or more.

Adjusting the Airflow Direction

1. Horizontal The horizontal airflow can be adjusted by moving the vertical vanes with your hands to the left or right.

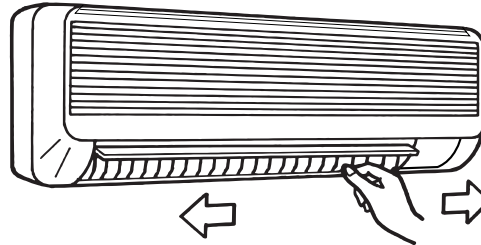

CAUTION

When the humidity is high, the vertical vanes should be in the front position during the cooling or dehumidifying operation. If the vertical vanes are positioned all of the way to the right or left, condensation may begin to form around the air vent and drip down.

2. Vertical

The vertical airflow can be adjusted by moving the flap with the remote control unit. Do not move the flap with your hands. Confirm that the remote control unit has been turned on. Use the FLAP button to set either the sweep function or one of the six airflow direction settings. (The maximum capacity is obtained at the position at 4 .)

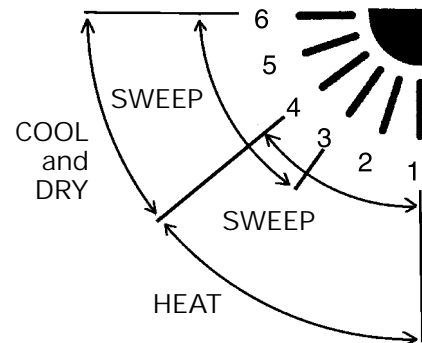
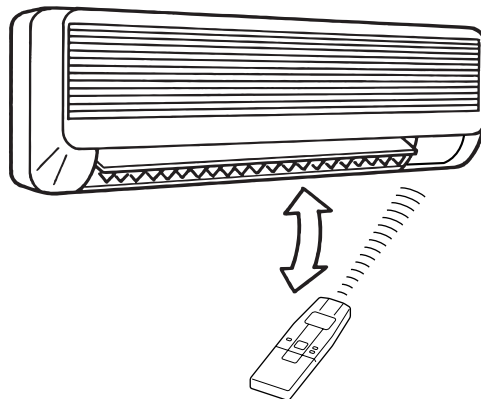
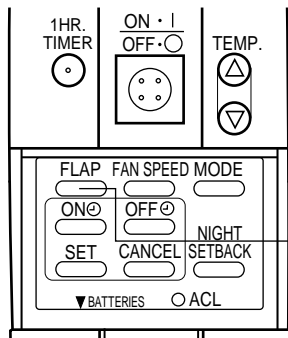

- A. Sweep function



The flap starts moving up and down to deliver air over the sweep range.

- B. Setting the airflow manually



Referring to the above illustration, use the FLAP button to set the airflow direction within the range used during the heating, cooling, or dehumidifying operation.

NOTE

- The flap automatically closes when the unit is off.
- During the heating operation, the fan speed will be very low and the flap will be in the horizontal position (position 6) until the air being blown out of the unit begins to warm. Once the air warms up, the flap position and fan speed change to the settings specified with the remote control.



CAUTION

- Use the FLAP button on the remote control to adjust the position of the flap. If you move the flap by hand, the flap position according to the remote control and the actual flap position may no longer match. If this should happen, shut off the unit, wait for the flap to close, and then turn on the unit again; the flap position will now be normal again.
- Do not have the flap pointed down during cooling operation. Condensation may begin to form around the air vent and drip down.

Operation without the Remote Control Unit

INDOOR UNIT
KHS0951
KHS1251

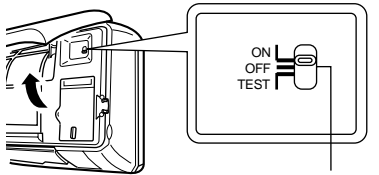

KHS1852

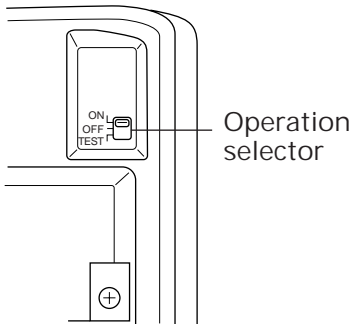

If you have lost the remote control unit or it has trouble, follow the steps below.

1. When the air conditioner is not running

If you want to turn on the air conditioner, switch the operation selector to the OFF position, and then to the ON position.

NOTE

The set temperature and fan speed are automatically set at the last selection before stopping.

2. When the air conditioner is running

If you want to turn off the air conditioner, switch the operation selector to the OFF position.

Care and Cleaning



WARNING

1. For safety, be sure to turn the air conditioner off and also to disconnect the power before cleaning.
2. Do not pour water on the indoor unit to clean it. This will damage the internal components and cause an electric shock hazard.

Casing and Grille
(Indoor Unit)

Clean the casing and grille of the indoor unit with a vacuum cleaner brush, or wipe them with a clean, soft cloth.

If these parts are stained, use a clean cloth moistened with a mild liquid detergent. When cleaning the grille, be careful not to force the vanes out of place.



CAUTION

1. Never use solvents, or harsh chemicals when cleaning the indoor unit. Do not wipe the plastic casing using very hot water.
2. Some metal edges and the fins are sharp and may cause injury if handled improperly; be especially careful when you clean these parts.
3. The internal coil and other components of the outdoor unit must be cleaned every year. Consult your dealer or service center.

Care and Cleaning (continued)

Anti-mold filter

The anti-mold filter behind the air intake grille should be checked and cleaned at least once every two weeks.

How to remove the anti-mold filter

1. Grasp both ends of the air intake grille and pull it out and up.
2. Push the anti-mold filter up slightly, and then pull it down.

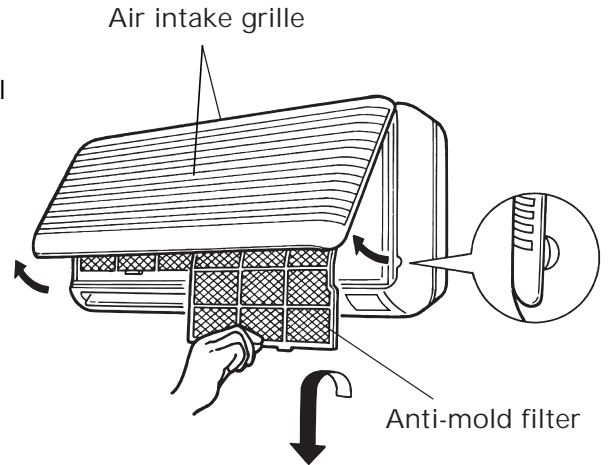

Cleaning

Use a vacuum cleaner to remove light dust. If there is sticky dust on the filter, wash the filter in lukewarm, soapy water, rinse it in clean water and dry it.

How to replace the anti-mold filter

1. With the "FRONT" mark facing you, slide the anti-mold filter up into the unit and then lower the handle into the groove on the unit.
2. After installing the anti-mold filter, press the locations marked by the arrows (↓) and close the air intake grille.

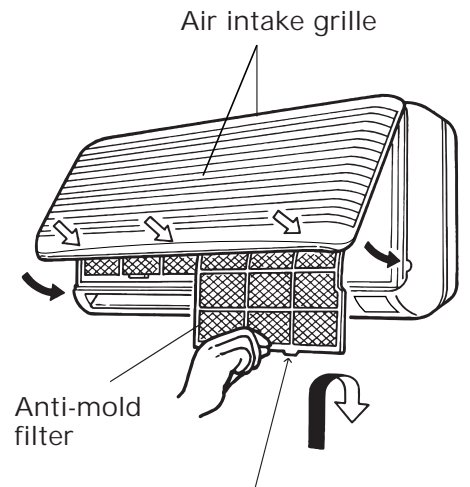

Insert into the groove on the unit.

Care and Cleaning (continued)

Air cleaning filter
(not provided)

The air cleaning filter removes dust and dirt from the air, and reduces odors and smoke from tobacco.

NOTE

KHS0951/KHS1251

The air cleaning filter is not provided with the air conditioner and must be purchased separately. The first time that you buy the air clean filter, it is necessary to get the STK-ARF4B model with frame. When changing the filter subsequently, it is only necessary to replace the filter itself (model STK-F4B). Do not throw away the filter frame.

KHS1852

The air clean filter is not provided with the air conditioner and must be purchased separately.
Ask for the STK-F4B model when purchasing.



WARNING

The air cleaning filter cannot remove harmful gases or vapors nor ventilate air in the room. You must open doors or windows frequently when you use gas or oil heating appliances. Otherwise there is a risk of suffocation in extreme cases.

How to install the air
cleaning filter

The air cleaning filter needs to be installed behind the anti-mold filter.

1. Remove the anti-mold filter.
2. To mount the STK-F4B, set the air clean filter(sold separately) at the mounting position with the black side facing the rear.
To mount the STK-ARF4B, mount the air clean filter in the position shown in the diagram with the (STK-F4B) FRONT marking facing the front.
3. Reinstall the anti-mold filter, and close the suction grill.

Air clean filter
(STK-F4B)

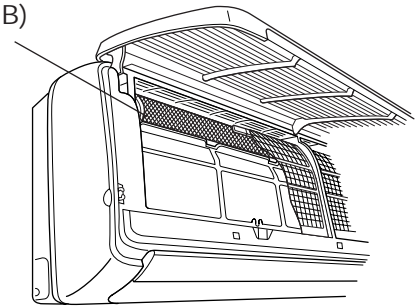

KHS1852

NOTE

- In general, the filter should be replaced once every three months.
- Dirty air clean filters cannot be washed and reused. Purchase a replacement filter at your local dealer.

Air clean filter
(STK-ARF4B)

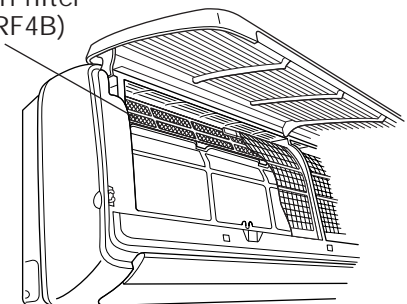

KHS0951/KHS1251

Cleaning the main unit and
remote control unit

- Wipe clean using a soft, dry cloth.
- To remove stubborn dirt, moisten a cloth in warm water no hotter than 104°F, wring thoroughly, and then wipe.
- The air intake grille can be removed in order to wash it with water.

Care and Cleaning (continued)

Removing and remounting the air intake grille

- With the air intake grille open all the way, grip both arms with your hands and pull toward you to remove. To remount, hold the air intake grille roughly horizontal and push it in until the arm shafts fit into the indentations in the main unit, then fit the grille into place.

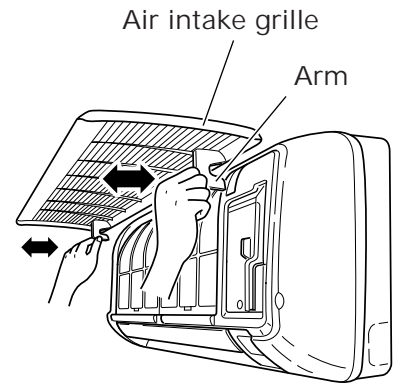

CAUTION

When using a footstool or the like, be careful not to let it tip over.

Washing the grille with water

- Clean the grille gently using a soft sponge, or the like. Then wipe away any remaining moisture.
- Neutral detergent may be used to remove stubborn dirt. Then rinse thoroughly with water and wipe away any remaining moisture.

Tips for Energy Saving

Do not

- Block the air intake and outlet of the unit. If they are obstructed, the unit will not work well, and may be damaged.
- Let direct sunlight into the room. Use sunshades, blinds or curtains. If the walls and ceiling of the room are warmed by the sun, it will take longer to cool the room.

Do

- Always try to keep the air filter clean. (Refer to "Care and Cleaning".) A clogged filter will impair the performance of the unit.
- To prevent conditioned air from escaping, keep windows, doors and any other openings closed.

Troubleshooting

If your air conditioner does not work properly, first check the following points before requesting service. If it still does not work properly, contact your dealer or service center.

Trouble	Possible Cause	Remedy
Air conditioner does not run at all.	<ol style="list-style-type: none"> 1. Power failure. 2. Leakage circuit breaker tripped. 3. Line voltage is too low. 4. Operation button is OFF. 5. Batteries in remote control unit have run down. 	<ol style="list-style-type: none"> 1. Restore power. 2. Contact service center. 3. Consult your electrician or dealer. 4. Press the button again. 5. Replace batteries.
OPERATION lamp flashes and air conditioner does not operate.	Trouble in wiring system.	Contact service center.
Compressor runs but soon stops.	Obstruction in front of condenser coil.	Remove obstruction.
Poor cooling (or heating) performance.	<ol style="list-style-type: none"> 1. Dirty or clogged air filter. 2. Heat source or many people in room. 3. Doors and/or windows are open. 4. Obstacle near air intake or air discharge port. 5. Thermostat is set too high for cooling (or too low for heating). 6. (Outdoor temperature is too low.) 	<ol style="list-style-type: none"> 1. Clean air filter to improve airflow. 2. Eliminate heat source if possible. 3. Shut them to keep the heat (or cold) out. 4. Remove it to ensure good airflow. 5. Set the temperature lower (or higher). 6. (Consult your dealer or try to use a back-up heater.)
Clicking sound is heard from the air conditioner.	In heating or cooling operation, any plastic parts may expand or shrink due to a sudden temperature change. In this event, a clicking sound may occur.	This is normal, and the sound will soon disappear.
OPERATION lamp lights but outdoor unit will not run.	1. The use of portable telephones near the air conditioner may cause disturbance to its normal operation.	<ol style="list-style-type: none"> 1. Turn off the power then restart the air conditioner after 1 minute. 2. Consult your dealer.

Operating Range

The air conditioner is operable within the temperature ranges as listed below:

	Temperature	Indoor Air Intake Temp.	Outdoor Air Intake Temp.
COOLING	Maximum	95 °F DB/71 °F WB	115 °F DB
	Minimum	67 °F DB/57 °F WB	67 °F DB
HEATING	Maximum	80 °F DB/67 °F WB	75 °F DB/65 °F WB
	Minimum	- DB/- WB	17 °F DB/15 °F WB

For Parts or Service Contact
SANYO FISHER SERVICE CORPORATION
A DIVISION OF SANYO LOGISTICS CORPORATION
1411 West 190th Street, Suite 800, Gardena, CA 90248 U.S.A.
50 Beth Neilson Drive, Toronto, Ontario, M4H 1M6, CANADA