

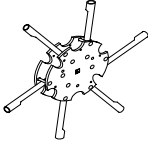

BILLY GOAT AERATOR

Owner's Manual

AE401, AE401H, AE401H5T & AE401S

Replacement Parts

TINE ROW KIT
Complete tine row set for replacement of one complete row of tines. Includes mounting plates, spacer, and all hardware.

P/N 360197

TINE KIT
Individual coring tine for replacement of worn or broken tines.

P/N 360100



ABOUT THIS MANUAL

THANK YOU for purchasing a BILLY GOAT[®] *Aerator*. Your new machine has been carefully designed and manufactured to provide years of reliable and productive service. This manual provides complete operating and maintenance instructions that will help to maintain your machine in top running order. Read this manual carefully before assembling, operating, or servicing your equipment.

CONTENTS

SERIAL PLATE DATA AND SPECIFICATIONS _____	<u>3</u>
GENERAL SAFETY _____	<u>4-5</u>
INSTRUCTION LABELS _____	<u>6</u>
PACKING CHECKLIST & ASSEMBLY _____	<u>7</u>
OPERATION _____	<u>8-10</u>
MAINTENANCE _____	<u>11-13</u>
TROUBLESHOOTING AND WARRANTY PROCEDURE _____	<u>14</u>
MAINTENANCE RECORD _____	<u>15</u>
ILLUSTRATED PARTS & PARTS LISTS _____	<u>16-19</u>



SERIAL PLATE DATA

Record the model number, serial number, date of purchase, and where purchased.

Purchase Date: _____

Purchased From: _____

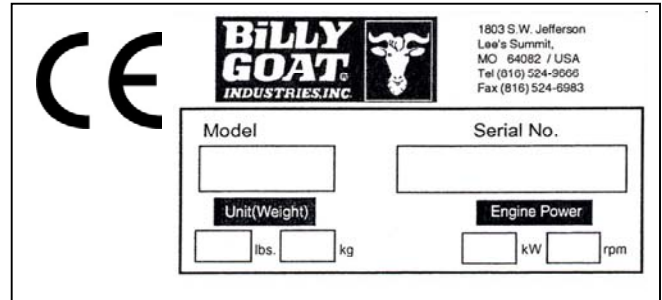

Specifications

	AE401	AE401H	AE401H5T	AE401S
Engine: HP	5.5 (4.1 kW)	4.0 (2.98 kW)	4.0 (2.98 kW)	4.0(2.98 Kw)
Engine: Model	1273520197B1	GX120K1HX2	GX120K1HX2	EH12-2
Engine: Type	B&S INTEK	HONDA OHV	HONDA OHV	SUBARU
Engine: Fuel Capacity	3.0 qt. (2.84 L)	2.1 qt. (2.0 L)	2.1 qt. (2.0 L)	3.8 qt (3.6 L)
Engine: Oil Capacity	0.66 qt. (0.62 L)	0.63 qt. (0.6 L)	0.63 qt. (0.6 L)	0.63 qt. (0.6 L)
Total Unit Weight:	244# (109.8 Kg)	242# (109.8 Kg)	248# (109.8 Kg)	244# (110.7 kg)
Max. operating slope	20°	20°	20°	20°

GENERAL SAFETY INSTRUCTIONS and SYMBOLS

The safety symbols shown below are used throughout this manual. You should become familiar with them before assembling, operating, or servicing this equipment.



WARNING: This symbol indicates important information that will prevent injury to yourself or others.



This symbol indicates ear protection is recommended when operating this equipment.



This symbol indicates eye protection is recommended when operating this equipment.



This symbol indicates gloves should be worn when servicing this equipment.



This symbol indicates that this manual and the engine manufacturer's manual should be read carefully before assembling, operation, or servicing this equipment.



CAUTION: This symbol indicates important information that will prevent damage to your BILLY GOAT[®] Aerator.



This symbol indicates the engine oil level should be checked before operating this equipment.

Read and make sure you thoroughly understand the following safety precautions before assembling, operating or servicing this equipment:



READ this manual and the engine manufacturer's manual carefully before assembling, operating, or servicing this equipment.



EAR PROTECTION is recommended when operating this equipment.



EYE PROTECTION is recommended when operating this equipment.



BREATHING PROTECTION is recommended when operating this equipment.



WARNING: **EXHAUST** from this product contains chemicals known to the State of California to cause cancer, birth defects or other reproductive harm.

DO NOT operate this equipment on any unimproved forested, brushy, or grass covered land unless a spark arrester is installed on the muffler as required by Section 4442 of the California Public Resources Code. The arrester must be maintained in good working order. Other states may have similar laws. Federal laws apply on federal lands.

















DO NOT run engine in an enclosed area. Exhaust gases contain carbon monoxide, an odorless and possibly fatal poison.



AE Owner's Manual



WARNING:

-  **DO NOT** run this equipment indoors or in any poorly ventilated area. Refueling outdoors is recommended.
 -  **DO NOT** refuel this equipment while the engine is running. Allow engine to cool for at least two minutes before refueling.
 -  **DO NOT** store gasoline near an open flame.
 -  **DO NOT** remove gas cap while engine is running.
 -  **DO NOT** start or operate engine if strong odor of gasoline is present.
 -  **DO NOT** start or operate engine if gasoline is spilled. Move equipment away from spill until gasoline has completely evaporated.
 -  **DO NOT** smoke while filling the fuel tank.
 -  **DO NOT** check for spark with spark plug or spark plug wire removed. Use an approved spark tester.
 -  **DO NOT** operate engine without a muffler. Inspect muffler periodically and replace if necessary. If equipped with muffler deflector, inspect deflector periodically and replace if necessary.
 -  **DO NOT** operate engine with grass, leaves or other combustible material near the muffler.
 -  **DO NOT** touch muffler, cylinder, or cooling fins when hot. Contact with hot surfaces may cause severe burns.
 -  **DO NOT** leave equipment unattended while in operation.
 -  **DO NOT** park equipment on a steep grade or slope.
 -  **DO NOT** operate equipment with bystanders in or near the work area.
 -  **DO NOT** allow children to operate this equipment.
 -  **DO NOT** operate equipment with guards removed.
 -  **DO NOT** operate equipment near hot or burning debris or any toxic or explosive materials.
 -  **DO NOT** operate equipment on slopes greater than specified in Specifications section of this manual.
 -  **DO NOT** operate barefoot or wearing open sandals. Always wear substantial footwear
 -  **DO NOT** place hands or feet underneath unit, or near any moving parts.
 -  **DO NOT** operate the machine while under the influence of alcohol or drugs.
 -  **DO NOT** aerate near drop-offs, ditches, or embankments. The operator could lose footing or balance
 -  **DO NOT** start engine without tine height adjust lever in up position and clutch bail engaged.
 -  **DO NOT** change the engine governor setting or overspeed the engine.
- ALWAYS** Stop the tine reel when crossing gravel drives, walks, or roads.
- ALWAYS** Shut the engine off and wait until the tine reel comes to complete stop before performing maintenance.
- ALWAYS** Use equipment only in daylight or good artificial light.
- ALWAYS** wear safety goggles or safety glasses with side shields
- ALWAYS** remove spark plug wire when servicing equipment to prevent accidental starting.
- ALWAYS** check fuel lines and fittings frequently for cracks or leaks. Replace if necessary.
- ALWAYS** store fuel in approved safety containers.



WARNING: Important

Remove all rocks, wire, string, etc. that can present a hazard during work prior to starting.



DO identify and mark all fixed objects to be avoided during work such as sprinkler heads, water valves, limbs, or clothes line anchors, etc.



AE Owner's Manual

INTENDED USE

INTENDED USE: This machine is designed for aerating established lawns and large grass covered areas. The machine should not be used for any other purpose than that stated above. DO NOT operate if excessive vibration occurs. If excessive vibration occurs, shut engine off immediately and check for damaged or worn tine reel, loose pulley bolts or set screws, loose engine or lodged foreign objects. (See trouble shooting section on page 14).

INSTRUCTION LABELS

The labels shown below were installed on your BILLY GOAT® Aerator. If any labels are damaged or missing, replace them before operating this equipment. Part numbers from the Illustrated Parts List are provided for convenience in ordering replacement labels. The correct position for each label may be determined by referring to the part numbers shown.



LABEL WARNING GUARDS
P/N 900327



LABEL EXPLOSIVE FUEL
P/N 400268

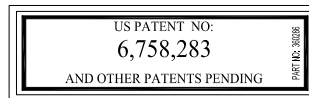

LABEL PATENT
P/N 360286



LABEL WARNING UNIT WEIGHT
P/N 360188



LABEL LIFT HERE
P/N 360187

LABEL INSTRUCTIONS AE
P/N 360025



ENGINE LABELS

SUBARU

HONDA

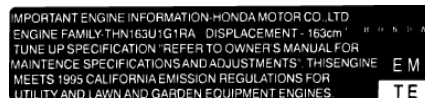
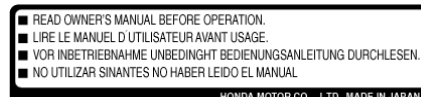

THROTTLE CONTROLS

Subaru



Honda

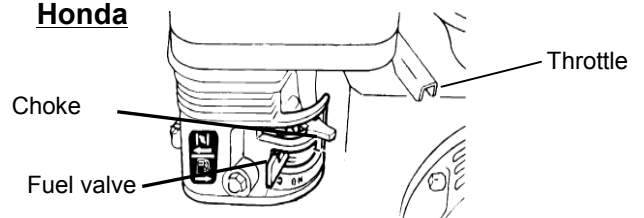



PACKING CHECKLIST

Your Billy Goat is shipped from the factory in one carton, completely assembled.



READ all safety instructions before assembling unit.
TAKE CAUTION when removing the unit from the box.



PUT OIL IN ENGINE BEFORE STARTING

PARTS BAG & LITERATURE ASSY

Warranty card P/N- 400972, Owner's Manual P/N-360314, Declaration of Conformity P/N-360194.

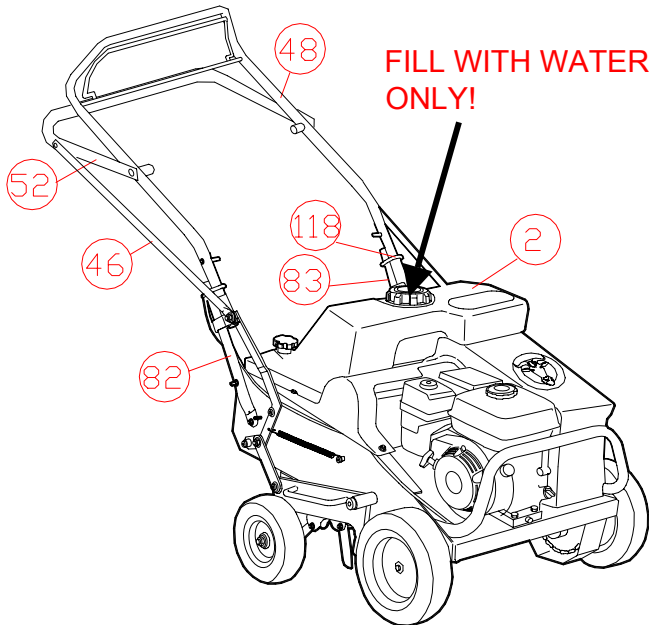

Boxing Parts Checklist

- Owner's Manual AE 360314
- Engine Manual Per Model
- Honda 4.0 HP
- Subaru 4.0 HP

ASSEMBLY

1. **HONDA AND SUBARU:** Unfold the upper handle (item 48) and slide handle lock loops (item 118) into place to secure the upper handle to the lower handle (item 82 & 83).
2. **PIVOT** the lift rod (item 46), insert the pin through the lift handle (item 52) then lock in place with lynch pin (item 47). Repeat same steps on other side.
3. **FILL** the water tank (item 2) to desired weight with water **ONLY**.
4. **CHECK** engine oil level and fill to proper level. Also check oil in gear reduction reservoir and fill if necessary. See engine owner's manual for type and amount of oil to use. Move the tine engagement lever to the down position, to level engine during checking.
5. **CONNECT** spark plug wire. Set the engine stop switch to the **ON** position. You will use the stop switch on the handle during operation.

OPERATION

 Like all mechanical tools, reasonable care must be used when operating machine. **Inspect machine work area and machine before operating. Make sure that all operators of this equipment are trained in general machine use and safety.**

 **PUT OIL IN ENGINE BEFORE STARTING**

STARTING

 **ENGINE:** See engine manufacturer's instructions for type and amount of oil and gasoline used. Engine must be level when checking and filling oil and gasoline.

GEAR REDUCTION: See engine manufacturer's instructions for type and amount of oil used. Engine must be level when checking and filling the gear reduction case. The engine is shipped from the factory with oil in the gear case. It should be checked before first use.

ENGINE SPEED: Controlled by lever on the engine. Under normal conditions, operate at the minimum throttle speed to accomplish your task.

NOTE: The unit ground speed varies with the engine speed.

FUEL VALVE: Move fuel valve to "ON" position
Honda: Located below the air cleaner on the engine.

CHOKE: Engage the choke when starting a cold engine.
Honda: Located below the air cleaner on the engine.

THROTTLE: Move the throttle control lever on the engine to fast position. Pull starting rope to start engine.

IF YOUR UNIT FAILS TO START:

See Troubleshooting on page 14.

NOTE: Honda engines are equipped with a low oil sensor to prevent engine damage. When it senses a low oil condition (i.e. unit is operating or sitting on a steep slope) the engine shuts down. The low oil condition must be corrected before the engine can be restarted. See the engine owner's manual for more information.

DO NOT operate if excessive vibration occurs. If excessive vibration occurs, shut engine off immediately and check for damaged or worn tine reel, loose pulley bolts or set screws, loose engine or lodged foreign objects. (See trouble shooting section on page 14).

HANDLING & TRANSPORTING:

 **CAUTION:** This unit is heavy. It requires at least two people to lift it.

REMOVE: The aerator is equipped with a water tank as weight. Drain the water using drain plug before loading and unloading the unit.

NOTE: The water tank is also heavy (up to 50 lbs.) when it is full of water. The tank should be drained then handled carefully and secured in place during transport.

LIFTING: The aerator is equipped with lift handles. After draining the water tank, lift the unit with two people, one on each side of the unit. Grip the unit at the points marked "LIFT HERE" when lifting. Lift using your legs and not your back. See Fig. 2

USING RAMPS: Use ramps that are of adequate strength for a unit of this weight. When loading the aerator using ramps be sure the ramp is not too steep and that the surface of the ramp provides good traction.

 Never lift the machine while the engine is running.

Fig 2



IT TAKES AT LEAST TWO PEOPLE. ONE ON EACH SIDE OF THE UNIT

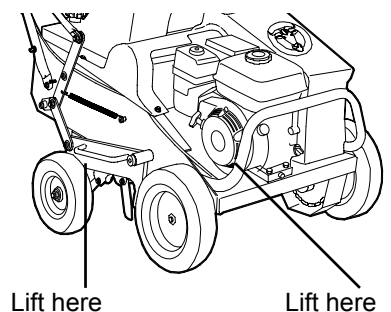

PARKING

NEVER PARK THIS UNIT ON A SLOPE OF ANY KIND. Always keep tines in the up position when parking the unit.

UNIT STORAGE

Never store engine indoors or in enclosed poorly ventilated areas with fuel in tank, where fuel fumes may reach an open flame, spark or pilot light, as on a furnace, water heater, clothes dryer or other gas appliance.

If engine is to be unused for 30 days or more, prepare as follows:

Remove all gasoline from carburetor and fuel tank to prevent gum deposits from forming on these parts and causing possible malfunction of engine. Drain fuel outdoors, into an approved container, away from open flame. Be sure engine is cool. Do not smoke. Run engine until fuel tank is empty and engine runs out of gasoline.

NOTE: Fuel stabilizer (such as Sta-Bil) is an acceptable alternative in minimizing the formation of fuel gum deposits during storage. Add stabilizer to gasoline in fuel tank or storage container. Always follow mix ratio found on stabilizer container. Run engine at least 10 min. after adding stabilizer to allow it to reach the carburetor.

TINES RAISING/LOWERING

The tines are raised or lowered into the ground by operating the tine engagement lever on the upper handle. Tine penetration is very dependent on surface preparation. READ the entire operation section before aerating.

AERATING OPERATION

MOW: Mow the lawn to its normal cut height.

WATER: For the best performance and maximum tine penetration the lawn should be thoroughly watered the day before aeration.

INSPECT lawn before beginning work. Remove all rocks, wire, string, or other objects that can present a hazard during work prior to starting.

IDENTIFY and mark all fixed objects to be avoided during work, such as sprinkler heads, water valves, buried cables, or clothes line anchors, etc.

START ENGINE: See page 8.

SET SPEED: The ground speed of your aerator varies with the engine speed. Set the engine at approximately half throttle to start. Speed may be increased based on the turf conditions (i.e. large flat areas) and operator experience. Speed should be lowered when operating under adverse turf conditions (i.e. fenced areas, hills, or slopes).

MOVE: Be sure the tine engagement control is in the up position (tines out of the ground) and engage the wheel drive by squeezing the operators clutch bail against the handle. Transport the aerator to the work area.

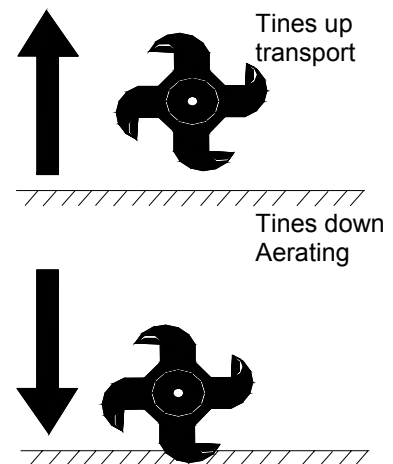
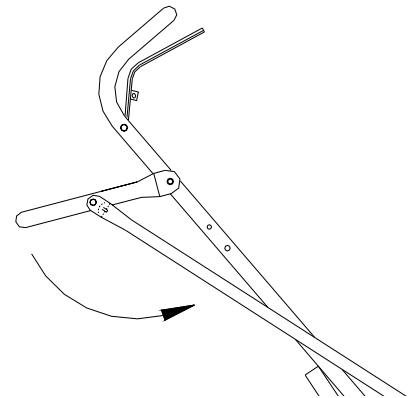



AE Owner's Manual

ENGAGE TINES: With the aerator in the work area, release the clutch bail and push forward on the tine engagement lever, lowering the tines into the dirt.

AERATE: Engage the operators clutch bail by pushing it pulling it backwards from the handle, and start aerating.

NOTE: For maximum tine penetration apply downward pressure on the handle.

TURNING: At the end of an aerating run, release the clutch bail and lift up on the tine engagement control to lift the tines out of the ground. Using the handle lift the front of the unit to pivot it around and line up for the next pass.

TRANSPORT: Be sure to lift the tine engagement lever (tines out of the ground) before transporting away from the work area.

AERATING TIPS

WATER: For the best performance and maximum tine penetration, the lawn should be thoroughly watered the day before aeration.

SLOPES: Do not operate the aerator on steep slopes. Use extreme caution when operating on any sloped surface. For lesser sloped areas operate the unit, traversing up and down at a 45 degree angle to the slope rather than straight across. Extended operation on steep slopes can cause engine damage.

NOTE: DO NOT release the operators clutch bail when operating on a slope. This will allow the unit to free wheel and allow the unit to roll down the slope.

NOTE: Honda engines are equipped with a low oil sensor to prevent engine damage. When it senses a low oil condition (i.e. unit is operating or sitting on a steep slope) the engine shuts down. The low oil condition must be corrected before the engine can be restarted. See the engine owner's manual for more information.

TINE PENETRATION: Maximum tine penetration is achieved by applying downward pressure on the handle during operation.

TURNING: At the end of a pass the tines can be lifted out of the ground to turn by lifting straight up on the operators handle.

FOLDING HANDLE

This unit is equipped with a folding upper handle for easier storage. TO FOLD THE HANDLE (See Fig. 3):

1. Slide handle lock loops (item 118) up on both sides.
2. Fold the upper handle (item 48).



Fig 3

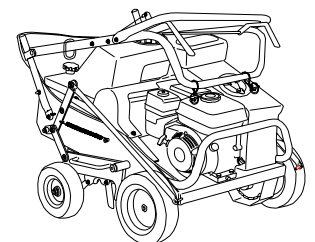

Fig 4



MAINTENANCE

PERIODIC MAINTENANCE

Periodic maintenance should be performed at the following intervals:

Maintenance Operation	Every Use (daily)	Every 25 hrs	Every 50 Hours
Inspect for loose, worn or damaged parts.		●	
Check engine oil.	●		
Inspect belt for wear.			●
Engine (See Engine Manual)			
Oil chains (see lubrication).		●	
Thoroughly clean all debris from unit and tine reel	●		
Check tine reel nut torque. Torque to min. 100 ft.lbs.			●
Check gear reduction oil level		●	
Grease bearings (see lubrication).			●

ENGINE MUST BE LEVEL WHEN CHECKING OR FILLING OIL

TINE REEL REMOVAL AND TINE ROW REPLACEMENT

TINE REEL REMOVAL

NOTE: Tine reel removal is only necessary to replace an entire tine row or for other major unit maintenance. Individual tines can be replaced by following the INDIVIDUAL TINE REPLACEMENT instructions.

1. Wait for engine to cool and disconnect spark plug.
2. Remove the top guard by removing the four nuts, two on each side that secures it to the frame.
3. Release the tension on the chain. See CHAIN TENSION ADJUSTMENT in this manual.
4. Remove the four bolts and nuts, two on each side, holding the tine reel bearings in place. BE CAREFUL the tine reel is heavy and sharp. Take precautions to not allow it to fall when the bearing bolts are removed.
5. Lift the reel up and to the side to remove it from the drive chain.
6. See TINE ROW REPLACEMENT for instructions on maintenance.
7. To reinstall the reel follow the above steps in reverse.
8. Replace the guard and reinstall the four nuts that secure it in place.

TINE ROW REPLACEMENT

1. Wait for engine to cool and disconnect spark plug.
2. Remove the top guard by removing the four nuts, two on each side that secures it to the frame.
3. Remove the tine reel per the TINE REEL REMOVAL instructions.
4. Remove the nut at the end of the tine reel shaft that secures the tine rows in place.
5. Remove the tine rows and spacers as necessary to replace the defective part. Be sure to note the order in which the spacers were removed for later reassembly.
6. Reassemble the tine reel in the exact order that it was disassembled.
7. Tighten the nut that secures the tine rows and spacers on the shaft. Torque the nut to a minimum of 100 ft.lbs. Check that all of the tine rows are tight by attempting to move them by hand.
8. Reinstall the tine reel per the TINE REEL REMOVAL instructions above.
9. Reset the tension on the chain.
10. Replace the guard and reinstall the four nuts that secure it in place.

TIP: Spraying tines with a rust preventing lubricant can increase tine life and allow for easier replacement of worn or damaged tines.



INDIVIDUAL TINES REPLACEMENT

1. Wait for engine to cool and disconnect spark plug.
2. Loosen but do not remove the outermost nut and carriage bolt that secure the damaged or worn tine.
3. Loosen and remove the innermost nut and carriage bolt that hold the tine in the reel.
4. Use a small pry bar and push the tine plates apart slightly to slide out the tine to be replaced.
5. Slide the new tine in place and secure with the innermost nut and carriage bolt. Tighten completely.
6. Retighten the outermost nut and carriage bolt to completely secure the new tine.
7. Repeat as required to replace all damaged or worn tines.

NOTE: Tines are a normal wear item and should be inspected regularly for signs of wear or damage.

BELT AND CHAIN TENSION ADJUSTMENT

ADJUSTING BELT TENSION-

1. Remove the top guard (item 3) by removing the four nuts (item 87), two on each side, that secure it to the frame.
2. Locate the top of the belt idler assembly where the clutch cable (item 55) is secured in place. A properly tensioned belt should stretch the idler spring (located next to the idler pulley) between 1/4" - 3/8" when the clutch bail (item 54) is held in the drive position.
3. Using a 1/2" wrench loosen the two nuts that secure the cable (item 55) in place.
4. TO INCREASE belt tension adjust these two nuts so that the cable (item 55) is secured in place with an additional 1/4" of the threaded adjuster at the top of the assembly.
TO DECREASE belt tension, adjust these two nuts so that the cable (item 55) is secured in place with 1/4" less of the threaded adjuster at the top of the assembly.
5. Replace the guard (item 3) and reinstall the four nuts (item 87) that secure it in place.
6. Run the unit to test your adjustment. Repeat as necessary to achieve proper adjustment. A properly adjusted belt will pull the unit up a 15 degree slope when clutched without any belt slip, and will declutch and stop the unit completely when the clutch is released.

NOTE: Never release the clutch on a slope. The unit is heavy and will free wheel down hill.

NOTE: A worn belt will not allow for proper adjustment and must be replaced.

ADJUSTING CHAIN TENSION-

1. Remove the top guard (item 3) by removing the four nuts (item 87), two on each side, that secure it to the frame.
2. Locate the bolt (item 31, 33) and nut (item 80) that hold each idler sprocket to the frame of the unit. One idler sprocket sets tension on the wheel drive chain and one sets tension on the tine drive chain.
3. Loosen the bolt and nut and slide the idler sprocket (item 29) in the desired direction.
INCREASED TENSION: Slide the sprocket to the rear.
DECREASED TENSION: Slide the idler sprocket to the front.
4. Tighten the bolt and nut to secure the sprocket in place.
5. Replace the guard and reinstall the four nuts that secure it in place.

NOTE: Over tensioning the chain will cause premature chain and sprocket wear. **DO NOT OVER TENSION THE CHAIN.** A properly tensioned chain will have slack of 1/4"-3/8" when moved by hand.



DRIVE BELT REPLACEMENT

1. Wait for engine to cool and disconnect spark plug.
2. Remove the top guard by removing the four nuts, two on each side, that secure it to the frame.
3. Slide the belt off of the engine drive pulley, and off of the jackshaft drive pulley.
4. Continue sliding the belt along the jackshaft to the right jackshaft bearing away from the pulley and sprockets.
5. Using a 9/16" wrench, remove the two bolts and nuts that hold the jackshaft bearing in place.
6. Carefully lift the jackshaft up until the belt can be slid out underneath the bearing.
7. Slide the new belt in place over the jackshaft.
8. Replace and tighten the bolts and nuts holding the jackshaft bearing in place. Be sure that the jackshaft is aligned straight across between both bearings.
9. Slide the belt along the jackshaft and over both engine and jackshaft pulleys. Be sure the idler pulley is positioned on the flat side of the belt.
10. Check proper belt tension. See BELT TENSION ADJUSTMENT in this manual.

CHAIN REPLACEMENT

NOTE: This procedure will work to change the wheel drive chain or the tine drive chain.

1. Wait for engine to cool and disconnect spark plug.
2. Remove the top guard by removing the four nuts, two on each side, that secure it to the frame.
3. Roll the unit until the master link of the chain that you want to replace is exposed near the jackshaft sprocket.
4. Release the tension on the chain. See CHAIN TENSION ADJUSTMENT in this manual.
5. Using a screwdriver or similar device, remove the spring clip that secures the master link in the chain.
6. With the master link removed unwind the chain from the two sprockets that it connects.
7. Carefully string the replacement chain around the same two sprockets and reconnect it with the new master link provided with your replacement chain.
8. Re set the tension on the chain.
9. Replace the guard and reinstall the four nuts that secure it in place.

LUBRICATION

BEARINGS-

1. Remove the top guard by removing the four nuts, two on each side that secures it to the frame. **NOTE:** Guard must be removed to lubricate the jackshaft bearings only. All other bearings can be lubed without removing the guard.
2. Lubricate all 6 bearings using a pressurized grease gun with standard lithium based grease.
3. Wipe any excess grease off of all bearings and fittings after each lubrication.
4. Replace the guard and reinstall the four screws that secure it in place.

CHAINS-

1. Remove the top guard by removing the four nuts, two on each side that secures it to the frame.
2. Apply a light coat of No. 30 Oil or a penetrating chain lubricant to keep the chain clean and in good running order.
3. Replace the guard and reinstall the four screws that secure it in place.

NOTE: If machine is cleaned with a pressure washer the chains and bearings should be lubricated after each cleaning.



Troubleshooting

Problem	Possible Cause	Solution
Engine will not start.	Stop switch off (Honda only). Throttle in off position. Engine not in full choke position. Out of gasoline. Bad or old gasoline. Spark plug wire disconnected. Dirty air cleaner. Engine oil level too low (Honda only).	Check stop switches, throttle, choke position and gasoline. Connect spark plug wire. Clean or replace air cleaner. Or contact a qualified service person. Check and fill engine oil.
Abnormal vibration.	Damaged or missing tines. Loose handle bolts. Loose engine bolts.	Stop work immediately. Replace any damaged or missing tines. Tighten all loose bolts and nuts.
Engine is making loud noise or squealing	Gear reduction oil level is low	Check and add oil according to engine owner's manual
Engine stalls or labors when aerating	Working on too steep of a slope. Not enough oil in the engine.	Work at 45 degrees to the slope moving up and down instead of across. Check and add engine oil.
Engine is locked, will not pull over.	Debris locked against reel, or drive pulleys. Engine problem.	Pull spark plug wire and remove debris. Contract an engine servicing dealer for engine problems.
Unit does not move when clutch is engaged.	Belt drive out of adjustment. Worn drive belt. Loose or damaged chain or sprockets. Loose or damaged pulleys. Damaged or broken clutch cable.	See maintenance on pg. 12 of this manual. Contact a qualified servicing dealer.

When servicing the engine refer to specific manufacturers engine owner's manual. All engine warranty is covered by the specific engine manufacturer. If your engine requires warranty or other repair work contact your local servicing engine dealer. When contacting a dealer for service it is a good idea to have your engine model number available for reference (See table page pg. 3). If you cannot locate a servicing dealer in your area you can contact the manufacturers national service organization.

To contact:

American Honda: 800-426-7701

Subaru America: 800-277-6246

WARRANTY CLAIM PROCEDURE

Should a BILLY GOAT[®] machine fail due to a defect in material and/or workmanship, the owner should make a warranty claim as follows:

- The machine must be taken to the dealer from whom it was purchased or to an authorized Servicing BILLY GOAT Dealer.
- The owner must present the remaining half of the Warranty Registration Card, or, if this is not available, the invoice or receipt.
- The Warranty Claim will be completed by the authorized BILLY GOAT Dealer and submitted to their respective BILLY GOAT Distributor for their territory Attention: Service Manager. Any parts replaced under warranty must be tagged and retained for 90 days. The model number and serial number of the unit must be stated in the Warranty Claim.
- The distributor service manager will sign off on the claim and submit it to BILLY GOAT for consideration.
- The Technical Service Department at BILLY GOAT will study the claim and may request parts to be returned for examination. BILLY GOAT will notify their conclusions to the distributor service manager from whom the claim was received.
- The decision by the Technical Service Department at BILLY GOAT to approve or reject a Warranty Claim is final and binding.

For online product registration go to www.billygoat.com

PARTS DRAWING AE

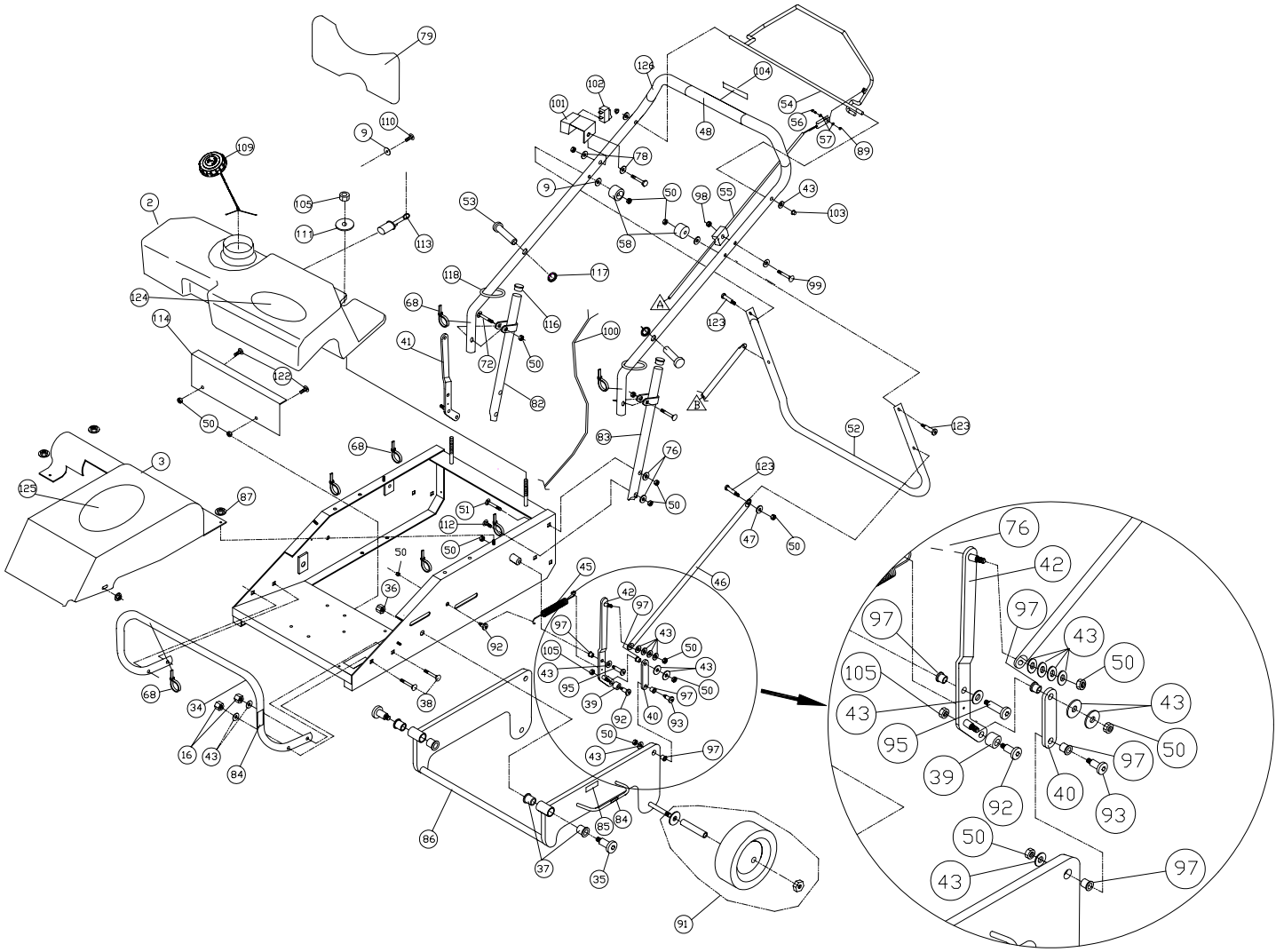



PARTS LIST AE

ITEM NO.	DESCRIPTION	AE401 Part No.	QTY	AE401H5T Part No.	QTY	AE401H Part No.	QTY	AE401S Part No.	QTY
2	WATER TANK 5.5 GAL	360238	1	360238	1	360238	1	360238	1
3	GUARD DRIVE COVER	360280	1	360280	1	360280	1	360305	1
9	WASHER 5/16 FENDER	8172020	5	8172020	5	8172020	5	8172020	5
16	NUT LOCK 3/8-16	8160003	4	8160003	4	8160003	4	8160003	4
34	TUBE FRONT BUMPER	360329	1	360329	1	360329	1	360329	1
35	BOLT SHOULDER 3/4 x 2.5	360146	2	360146	2	360146	2	360146	2
36	NUT LOCK 5/8-11 THIN	8161046	2	8161046	2	8161046	2	8161046	2
37	BUSHING PIVOT	360183	4	360183	4	360183	4	360183	4
38	BOLT CARRIAGE 3/8-16 x 1.75"	8024061	4	8024061	4	8024061	4	8024061	4
39	TUBE SPACER	830526-P	2	830526-P	2	830526-P	2	830526-P	2
40	BRACKET LIFT LINK	360246	2	360246	2	360246	2	360246	2
41	LINK LIFT RIGHT	360300	1	360300	1	360300	1	360300	1
42	LINK LIFT LEFT	360299	1	360299	1	360299	1	360299	1
43	WASHER FLAT 3/8 SAE	8172009	22	8172009	22	8172009	22	8172009	22
45	SPRING EXTENSION	360154	2	360154	2	360154	2	360154	2
46	ROD LIFT	360297	2	360297	2	360297	2	360297	2
47	WASHER 5/16 SAE ZP	8172008	2	8172008	2	8172008	2	8172008	2
48	HANDLE UPPER AE	350375	1	350375	1	350375	1	350375	1
50	NUT LOCK 5/16-18	8160002	20	8160002	20	8160002	20	8160002	20
51	CARRIAGE BOLT 5/16-18X1.50	8024042	2	8024042	2	8024042	2	8024042	2
52	HANDLE LIFT	360296	1	360296	1	360296	1	360296	1
53	CLEVIS PIN 3/8" X 1.625	520119	2	520119	2	520119	2	520119	2
54	BAIL CLUTCH	350374	1	350374	1	350374	1	350374	1
55	CABLE CLUTCH ASSY	360313	1	360313	1	360313	1	360313	1
56	SCREWCAP #10 - 24 X 0.625	8059135	1	8059135	1	8059135	1	8059135	1
57	WASHER #10 SAE FLAT	8172005	2	8172005	2	8172005	2	8172005	2
58	BUMPER RECESS	360298	2	360298	2	360298	2	360298	2
68	TY-WRAP	900407	10	900407	10	900407	10	900407	10
72	CARRIAGE BOLT 5/16-18X1.75	8024043	2	8024043	2	8024043	2	8024043	2
76	WASHER 1/4 FLAT CUT	8171002	7	8171002	7	8171002	7	8171002	7
79	LABEL TANK INSTRUCTIONS AE	360025	1	360025	1	360025	1	360025	1
82	HANDLE LOWER RIGHT WA	360270	1	360270	1	360270	1	360270	1
83	HANDLE LOWER LEFT WA	360269	1	360269	1	360269	1	360269	1
84	LABEL LIFT HERE	360187	4	360187	4	360187	4	360187	4
85	LABEL WARNING WEIGHT	360188	2	360188	2	360188	2	360188	2
86	FRAME REAR WA	360267	1	360267	1	360267	1	360267	1
87	NUT FLANGE 1/4-20	900453	4	900453	4	900453	4	900453	4
89	LOCKNUT #10-24	8164005	1	8164005	1	8164005	1	8164005	1
91	TIRE & WHEEL 8" ASSY	360334	2	360334	2	360334	2	360334	2
92	BOLT SHOULDER 3/8 x 1/2"	830528	4	830528	4	830528	4	830528	4
93	BOLT SHOULDER 3/8 x 1"	360152	2	360152	2	360152	2	360152	2
95	BOLT SHOULDER 3/8 x 2"	360153	2	360153	2	360153	2	360153	2
97	BUSHING SHOULDER NYLON 3/8 ID	360175	8	360175	8	360175	8	360175	8
98	NUT LOCK 1/4x 20 THIN	8160001	1	8160001	1	8160001	1	8160001	1
99	SCREW CAP 1/4 - 20 x 1 1/2"	8041009	1	8041009	1	8041009	1	8041009	1
100	HARNESS WIRE AE	360199	1	360199	1	360199	1	360316	1
101	BRACKET MOUNT SWITCH	430141	1	430141	1	430141	1	430141	1
102	SWITCH ON-OFF	500281	1	500281	1	500281	1	500281	1
103	NUT - PAL 3/8	360218	2	360218	2	360218	2	360218	2
104	CLUTCH LABEL	830503	1	830503	1	830503	1	830503	1
105	NUT LOCK 5/16 -18 THIN	8161041	6	8161041	6	8161041	6	8161041	6
107	PLASTIC LANYARD	360243	3	360243	3	360243	3	360243	3
109	CAP WATER TANK	360256	1	360256	1	360256	1	360256	1
110	SCREW SELF TAP 1/4-20 x 5/8"	430361	1	430361	1	430361	1	430361	1
111	WASHER - EXTENSION	810652	2	810652	2	810652	2	810652	2
112	CARRIAGE BOLT 5/8" X 34"	8024039	2	8024039	2	8024039	2	8024039	2
113	PLUG DRAIN 1"	360293	1	360293	1	360293	1	360293	1
114	GUARD PLUG AE	360292	1	360292	1	360292	1	360292	1
116	PLUG CAP 1" TUBE	890132	2	890132	2	890132	2	890132	2
117	RETAINER 3/8"	360279	2	360279	2	360279	2	360279	2
118	LOOP FOLDING HANDLE	350138	2	350138	2	350138	2	350138	2
122	SCREWCAP 5/16-18 x 3/4	8041026	2	8041026	2	8041026	2	8041026	2
123	BOLT SHOULDER 3/8 x 1 1/4"	360284	4	360284	4	360284	4	360284	4
124	LABEL BILLY GOAT OVAL	360274	1	360274	1	360274	1	360274	1
125	LABEL BILLY GOAT CIRCLE	430303	1	430303	1	430303	1	430303	1
126	GRIP	400570	2	400570	2	400570	2	400570	2



PARTS DRAWING AE

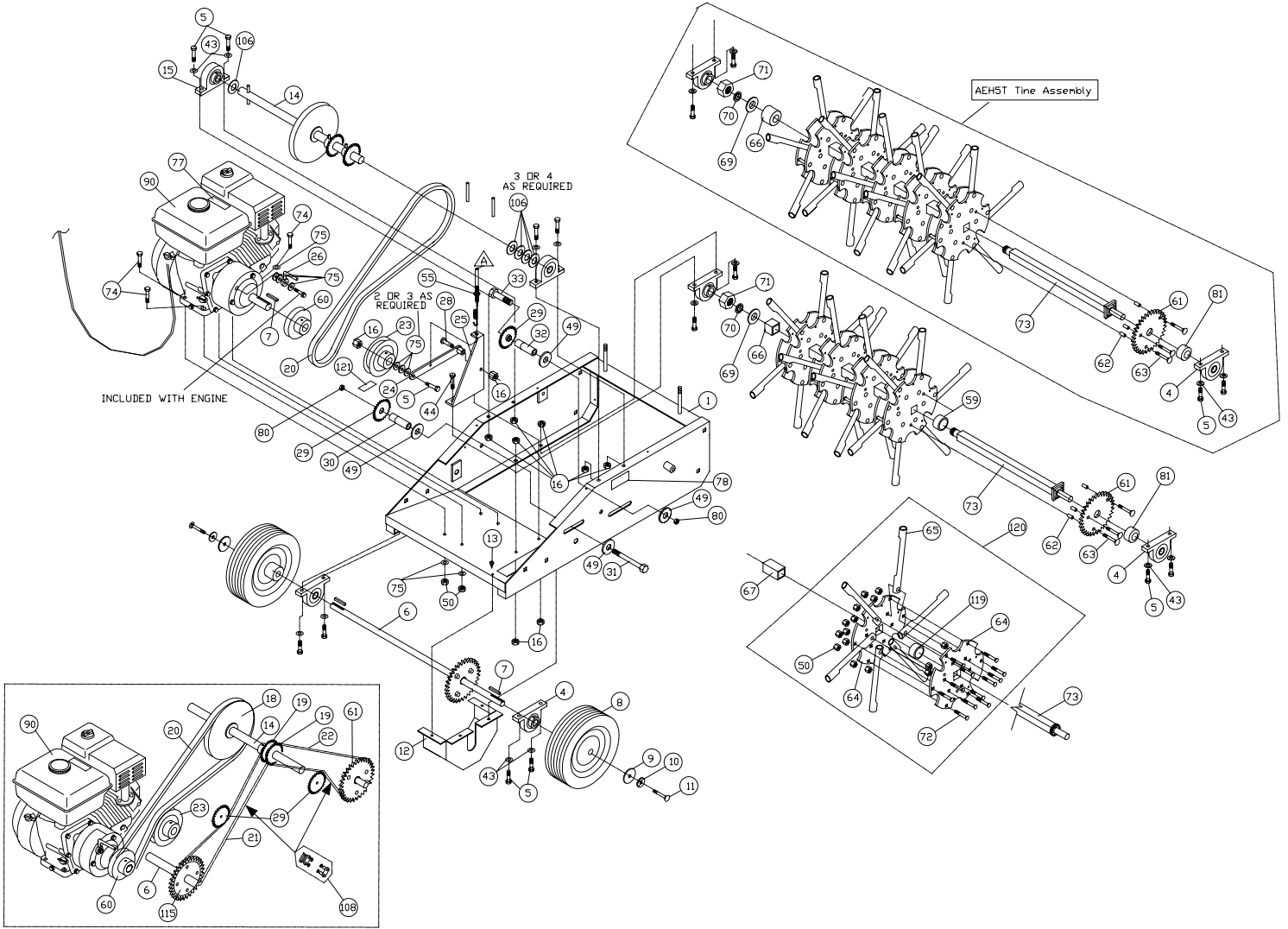



PARTS LIST AE

ITEM NO.	DESCRIPTION	AE401 Part No.	QTY	AE401H5T Part No.	QTY	AE401H Part No.	QTY	AE401S Part No.	QTY
1	FRAME ASSEMBLY WA AE401	360304	1	360304	1	360304	1	360304	1
4	BEARING 3/4" PILLOW BLOCK	350133	4	350133	4	350133	4	350133	4
5	SCREWCAP 3/8-16 x 1 1/2	8041052	12	8041052	8	8041052	12	8041052	12
	SCREWCAP 3/8-16 x 1 1/4"	-	-	8041051	4	-	-	-	-
6	FRONT AXLE ASSY	360332	1	360332	1	360332	1	360332	1
7	KEY SQUARE 3/16 x 3/16 x 1.25	9201080	3	9201080	3	9201080	3	9201080	3
8	WHEEL 10.5" SEMI PN. W3/4" KEYED HUB	360388	2	360388	2	360388	2	360388	2
9	FENDER WASHER 5/16"	8172020	3	8172020	3	8172020	3	8172020	3
10	WASHER LOCK 5/16 TWISTED TOOTH	430298	2	430298	2	430298	2	430298	2
11	SCREWCAP 5/16-18 x 1"	8041028	2	8041028	2	8041028	2	8041028	2
12	GUARD DIFFERENTIAL AE	360248	1	360248	1	360248	1	360248	1
13	SCREW SELF TAP 1/4 x 1/2"	8122080	2	8122080	2	8122080	2	8122080	2
14	JACKSHAFT AERATOR ASSY	360331	1	360331	1	360331	1	360331	1
15	BEARING 1" PILLOW BLOCK	810700	2	810700	2	810700	2	810700	2
16	NUT LOCK 3/8-16	8160003	16	8160003	15	8160003	16	8160003	16
20	BELT 4L x 43" POWER RATED	360120	1	360120	1	360120	1	360120	1
21	CHAIN #40 x 94 PITCH O-RING (WHEEL)	360115	1	360115	1	360115	1	360115	1
22	CHAIN #40 x 76 PITCH O-RING (TINE)	360114	1	360114	1	360114	1	360114	1
23	PULLEY IDLER 4.5"	500270	1	500270	1	500270	1	500270	1
24	ARM IDLER WA	510199	1	510199	1	510199	1	510199	1
25	BRACKET MOUNT IDLER	360121	1	360121	1	360121	1	360121	1
26	BELT FINGER FRONT AE	360219	1	360219	1	360219	1	360219	1
27									
28	BOLT SHOULDER 1/2 x 1	500114	1	500114	1	500114	1	500114	1
29	SPROCKET IDLER 17T x 5/8" BORE	360116	2	360116	2	360116	2	360116	2
30	SPACER SPROCKET IDLER 2.5"	360123	1	360123	1	360123	1	360123	1
31	SCREW CAP 1/2 - 13 x 4	8041106	1	8041106	1	8041106	1	8041106	1
32	SPACER SPROCKET IDLER 1.175"	360124	1	360124	1	360124	1	360124	1
33	SCREW CAP 1/2 - 13 x 3"	8041102	1	8041102	1	8041102	1	8041102	1
43	WASHER FLAT 3/8 SAE	8172009	12	8172009	12	8172009	12	8172009	12
44	SCREWCAP 3/8 -16 x1	8041050	2	8041050	2	8041050	2	8041050	2
49	FLAT WASHER 1/2"	8171006	4	8171006	4	8171006	4	8171006	4
50	NUT LOCK 5/16-18	8160002	55	8160002	68	8160002	55	8160002	55
55	CABLE CLUTCH ASSY	360313	1	360313	1	360313	1	360313	1
59	SPACER TINE SPROCKET END	360108	1	-	-	360108	1	360108	1
60	PULLEY ENGINE	610417	1	610417	1	610417	1	610417	1
61	SPROCKET 42 T	360106	1	360106	1	360106	1	360106	1
62	SPACER - TINE SPROCKET 1.468	360272	3	360107	3	360272	3	360272	3
63	SCREW CAP 5/16-18 x 2.50"	8041034	3	-	-	8041034	3	8041034	3
	SCREWCAP 5/16-18 X 1 3/4" HCS ZP	-	-	8041031	3	-	-	-	-
64	TINE PLATE	360101	8	360101	10	360101	8	360101	8
65	TINE	360100	24	360100	30	360100	24	360100	24
66	SPACER - NUT RIGHT END	360266	1	360282	1	360266	1	360266	1
67	SPACER - BETWEEN TINE ASSEMBLIES	360265	3	360104	4	360265	3	360265	3
69	HEAVY WASHER TINE ASSY	830113	1	830113	1	830113	1	830113	1
70	WASHER LOCK 7/8" INTERNAL	350154	1	350154	1	350154	1	350154	1
71	NUT JAM 7/8 -14 (Torque 100 ft.lbs)	350155	1	350155	1	350155	1	350155	1
72	CARRIAGE BOLT 5/16-18X1.75	8024043	48	8024043	60	8024043	48	8024043	48
73	SHAFT TINE DRIVE	360102	1	360102	1	360102	1	360102	1
74	SCREW CAP 5/16 - 18 x 1.5"	8041030	4	8041030	4	8041030	4	8041030	4
75	WASHER FLAT CUT 5/16	8171003	9 OR 10	8171003	9 OR 10	8171003	9 OR 10	8171003	9 OR 10
77	LABEL HOT ENGINE	400268	1	400268	1	400268	1	400268	1
78	LABEL DANGER GUARD	900327	2	900327	2	900327	2	900327	2
80	NUT LOCK 1/2 -13 THIN	8161044	2	8161044	2	8161044	2	8161044	2
81	SPACER BEARING/SPROCKET 0.375 THK	360109	1	360109	1	360109	1	360109	1
90	ENGINE	360127	1	360278	1	360278	1	360306	1
94	LOCKNUT 3/8" - 16 THIN HGT	8161042	1	8161042	1	8161042	1	8161042	1
106	WASHER 1.062" ID X 1.75 OD	8172021	4 OR 5	8172021	4 OR 5	8172021	4 OR 5	8172021	4 OR 5
108	CHAIN MASTER LINK	360205	2	360205	2	360205	2	360205	2
119	SPACER - TINE PLATES	360105	4	360105	5	360105	4	360105	4
120	TINE ASSY (INCLUDES 50,64,65,72,&119)	360197	1	360197	1	360197	1	360197	1
121	RUBBER PAD 1/8" TK X 1/2" W	350310	1	350310	1	350310	1	350310	1



AE Owner's Manual

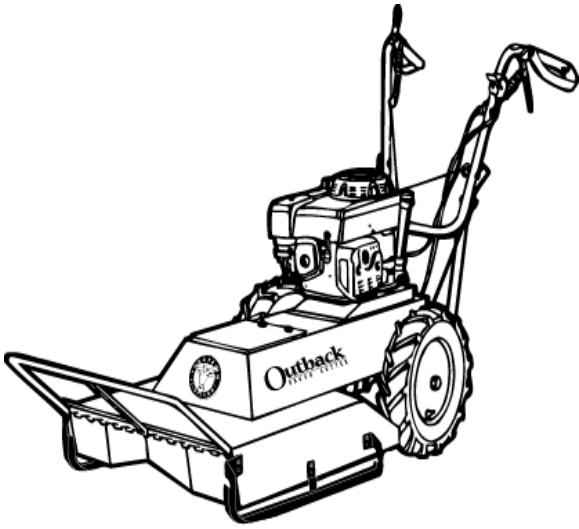

BRUSH CUTTER

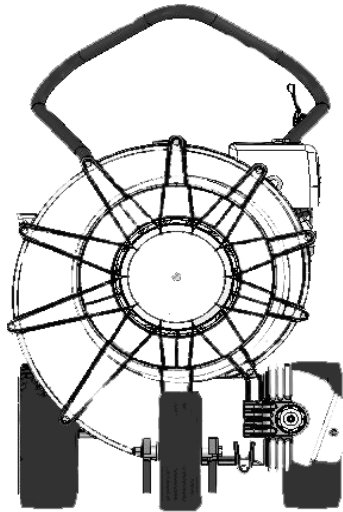

FORCE BLOWER

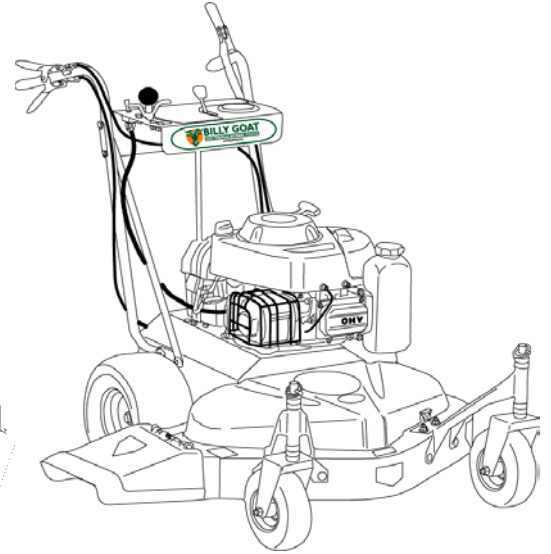

FINISH MOWER

If you liked this product please feel free to view our full line of quality lawn care, renovation, and debris removal products at www.billygoat.com

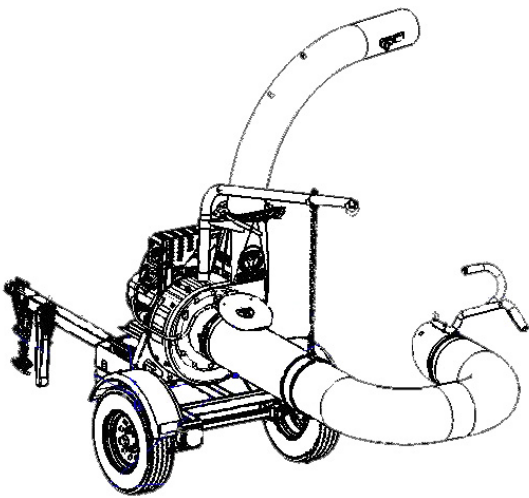

QL VACUUM

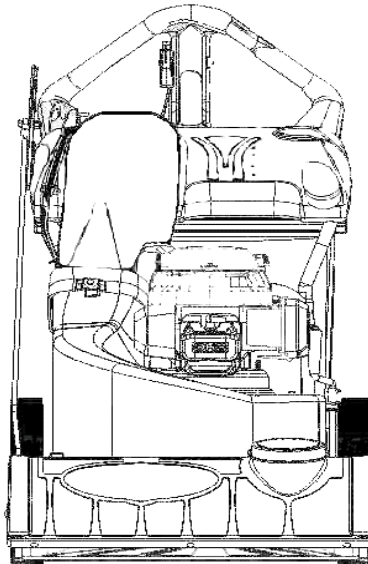

MULTI VACUUM

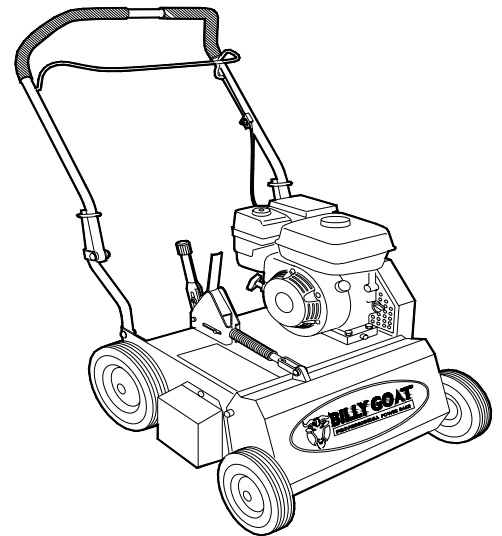

POWER RAKE

