

FES 8916

Fanless Embedded Controller

User Manual

FES8916: Fanless Embedded Controller, 6-slot system with
Socket P Intel Core 2 Duo Processor



FES 8916

Fanless Embedded Controller

Disclaimers

This manual has been carefully checked and believed to contain accurate information. Acnodes Corporation assumes no responsibility for any infringements of patents or any third party's rights, and any liability arising from such use.

Acnodes does not warrant or assume any legal liability or responsibility for the accuracy, completeness or usefulness of any information in this document. Acnodes does not make any commitment to update the information in this manual.

Acnodes reserves the right to change or revise this document and/or product at any time without notice.

No part of this document may be reproduced, stored in a retrieval system, or transmitted, in any form or by any means, electronic, mechanical, photocopying, recording, or otherwise, without the prior written permission of ACNODES CO., Ltd.

Copyright 2009 Acnodes
Corporation All Rights Reserved
December 2009, Version A2
Printed in Taiwan



FES 8916

Fanless Embedded Controller

Safety Precautions

1. The FES 8916 does not come equipped with an operating system. An operating system must be loaded first before installing any software into the computer.
2. Be sure to ground yourself to prevent static charge when installing the internal components. Use a grounding wrist strap and place all electronic components in any static- shielded devices. Most electronic components are sensitive to static electrical charge.
3. Disconnect the power cord from the FES 8916 before any installation. Be sure both the system and external devices are turned OFF. A sudden surge of power could ruin sensitive components that the FES 8916 must be properly grounded.
4. The brightness of the flat panel display will be getting weaker as a result of frequent usage. However, the operating period varies depending on the application environment.
5. Turn OFF the system power before cleaning. Clean the system using a cloth only. Do not spray any liquid cleaner directly onto the screen. The FES 8916 may come with or w/o a touch screen. Although the touch screen is chemical resistant, it is recommended that you spray the liquid cleaner on a cloth first before wiping the screen. In case your system comes without the touch screen, you must follow the same procedure and not spray any cleaner on the flat panel directly.
6. Avoid using sharp objects to operate the touch screen. Scratches on the touch screen may cause malfunction or internal failure to the touch screen.
7. The flat panel display is not susceptible to shock or vibration. When assembling the FES 8916, make sure it is securely installed.
8. Do not open the system's back cover. If opening the cover for maintenance is a must, only a trained technician is allowed to do so. Integrated circuits on computer boards are sensitive to static electricity. To avoid damaging chips from electrostatic discharge, observe the following precautions:

Before handling a board or integrated circuit, touch an unpainted portion of the system unit chassis for a few seconds. This will help to discharge any static electricity on your body. When handling boards and components, wear a wrist- grounding strap, available from most electronic component stores.



FES 8916

Fanless Embedded Controller

Classification

1. Degree of protection against electric shock: not classified
2. Degree of protection against the ingress of water: IPX0
3. Equipment not suitable for use in the presence of a flammable anesthetic mixture with air or with oxygen or nitrous oxide.
4. Mode of operation: Continuous
5. Type of protection against electric shock: Class I equipment

General Cleaning Tips

You may need the following precautions before you begin to clean the computer. When you clean any single part or component for the computer, please read and understand the details below fully.

When you need to clean the device, please rub it with a piece of dry cloth.

1. Be cautious of the tiny removable components when you use a vacuum cleaner to absorb the dirt on the floor.
2. Turn the system off before you start to clean up the component or computer.
3. Never drop the components inside the computer or get circuit board damp or wet.
4. Be cautious of all kinds of cleaning solvents or chemicals when you use it for the sake of cleaning. Some individuals may be allergic to the ingredients.
5. Try not to put any food, drink or cigarette around the computer.

Cleaning Tools:

Although many companies have created products to help improve the process of cleaning your computer and peripherals users can also use household items to clean their computers and peripherals. Below is a listing of items you may need or want to use while cleaning your computer or computer peripherals.

Keep in mind that some components in your computer may only be able to be cleaned using a product designed for cleaning that component, if this is the case it will be mentioned in the cleaning.

- Cloth: A piece of cloth is the best tool to use when rubbing up



FES 8916

Fanless Embedded Controller

a component. Although paper towels or tissues can be used on most hardware as well, we still recommend you to rub it with a piece of cloth.

- Water or rubbing alcohol: You may moisten a piece of cloth a bit with some water or rubbing alcohol and rub it on the computer. Unknown solvents may be harmful to the plastics parts.
- Vacuum cleaner: Absorb the dust, dirt, hair, cigarette particles, and other particles out of a computer can be one of the best methods of cleaning a computer. Over time these items can restrict the airflow in a computer and cause circuitry to corrode.
- Cotton swabs: Cotton swabs moistened with rubbing alcohol or water are excellent tools for wiping hard to reach areas in your keyboard, mouse, and other locations.
- Foam swabs: Whenever possible it is better to use lint free swabs such as foam swabs.



Note *It is strongly recommended that you should shut down the system before you start to clean any single components.*

Please follow the steps below:

1. Close all application programs
2. Close operating software
3. Turn off power switch
4. Remove all device
5. Pull out power cable



FES 8916

Fanless Embedded Controller

Scrap Computer Recycling

If the computer equipments need the maintenance or are beyond repair, we strongly recommended that you should inform your Acnodes distributor as soon as possible for the suitable solution. For the computers that are no longer useful or no longer working well, please contact your Acnodes distributor for recycling and we will make the proper arrangement.

Trademarks Acknowledgments

Acnodes is a trademark of Acnodes Co., Ltd.

IBM, PC/AT, PS/2, VGA are trademarks of International Business Machines Corporation.

Intel[®] and Pentium[®] are registered trademarks of Intel Corporation.

MS-DOS, Microsoft C and QuickBASIC are trademarks of Microsoft Corporation.

VIA is a trademark of VIA Technologies, Inc.

SST is a trademark of Silicon Storage Technology, Inc.

UMC is a trademark of United Microelectronics Corporation.

Other brand names and trademarks are the properties and registered brands of their respective owners.



FES 8916

Fanless Embedded Controller

Table of Contents

Disclaimers	ii
Safety Precautions.....	iii
Classification.....	iv
General Cleaning Tips.....	iv
Scrap Computer Recycling.....	vi
CHAPTER 1 INTRODUCTION	1
1.1 General Description	1
1.2 System Specifications.....	2
1.2.1 Main CPU Board	2
1.2.2 I/O System	2
1.2.3 System Specification	3
1.3 Dimensions	4
1.4 I/O Outlets.....	5
1.5 Jumper Settings	6
1.6 Packing List	11
CHAPTER 2 HARDWARE INSTALLATION	12
2.1 Installing the Processor.....	12
2.2 Installing the Memory Module.....	15
2.3 Installing the Hard Disk Drive.....	17
2.4 Installing the PCI Card.....	19
CHAPTER 3 DRIVER INSTALLATION	21
3.1 Starting.....	21
3.2 Navigation Keys.....	21
3.3 The Main Menu.....	22



FES 8916

Fanless Embedded Controller

3.4	Advanced BIOS Features.....	23
3.5	PCI PnP Menu.....	39
3.6	Boot Menu.....	41
3.7	Security Menu.....	44
3.8	Exit Menu.....	49



FES 8916

Fanless Embedded Controller

CHAPTER 1 INTRODUCTION

This chapter contains general information and detailed specifications of the FES 8916 Chapter 1 includes the following sections:

General Description

System Specification

Dimensions

I/O Outlets

Package List

1.1 General Description

The FES8916 is an fanless system that can support Socket P for Intel® Core™ 2 Duo/ Core™ Duo or Celeron® M processors. The FES8916 supports Windows® XP, ® Windows XP embedded, vista, and Fedora, suitable for the most endurable operation.

Reliable and Stable Design

The FES8916 adopts an anti-vibration hard-drive bay, which makes it especially suitable for vibration environments, best for industrial automation, digital signage and gaming application.

Embedded O.S. Supported

The FES8916 not only supports Windows® XP, but also supports embedded OS, such as Windows® XP embedded. For storage device, the FES8916 supports one 2.5" HDD driver bay and one onboard CompactFlash™ socket.



FES 8916

Fanless Embedded Controller

1.2 Specifications

1.2.1 Main CPI board

CPU:

Socket P Intel Core 2 Duo/ Celeron M processors

System Chipset: Intel GM45+ICH9M chipset

BIOS:

AMI BIOS, with Smartview and Customer CMOS Backup.

System Memory:

Two 204-pin DDR3 800/1066 MHz SODIMM sockets, with maximum up to 8GB

Features:

- Fanless Operation
- Compact & Front IO design
- Supports four PCI or four PCI & PCIe expansion slots
- DC to DC power supply support 10V to 30V

1.2.2 I/O System

Standard I/O Interface- Front:

- ATX power on/off switch
- 10VDC to 30VDC with phoenix power plug or External 150W AC Adapter
- Two USB 2.0 ports
- HDD access/power LEDs
- One RS-232(COM2/3/4)
- One RD-232/422/485(COM1)
- One VGA connector
- Two G.E. LAN ports

FES 8916

Fanless Embedded Controller

Optional I/O through bracket (Customer Selectable)

- Four USB
- One DVI-D

Expansion Slot:

- Two PCI & Three PCIe1 & One PCIe16 slots



NOTE The maximum power rating for expansion slots at 45°C can not be exceeded the following values
 $+5V+5Vsb+3.3V < 34W$
 $+5V+3.3V+12V < 48W$

1.2.3 System Specification

Drive Capacity:

- Supports one 2.5" HDD driver bay; one onboard CompactFlash socket

Power Input:

- 10VDC to 30VDC with phoenix power plug
- External 150W AC Adapter

Power Input: 90VAC to 264VAC, 7.89A 47/63Hz

Power Output: 19VDC

Operating temperature:

- Ambient with air flow: 0°C to 45°C

Storage Temperature:

- 20°C to 80°C

Relative humidity: 10% to 90%, non-condensing

Dimensions: 8.3" (W) x 9.8" (D) x 7.3" (H)



NOTE All specifications and images are subject to change without notice.

FES 8916

Fanless Embedded Controller

1.3 Dimensions

The following diagrams show the dimensions and outlines of FES8914.

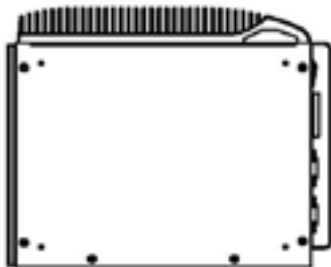
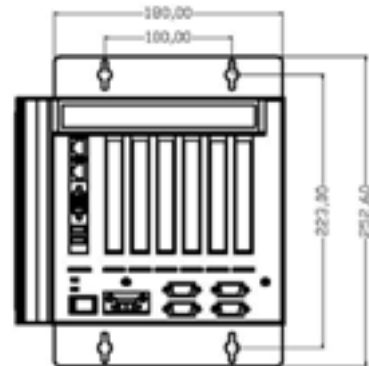
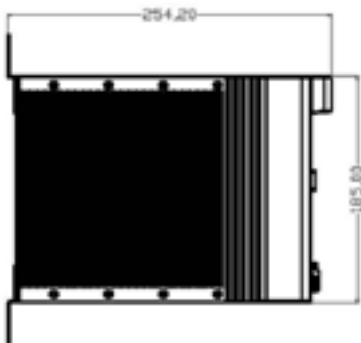
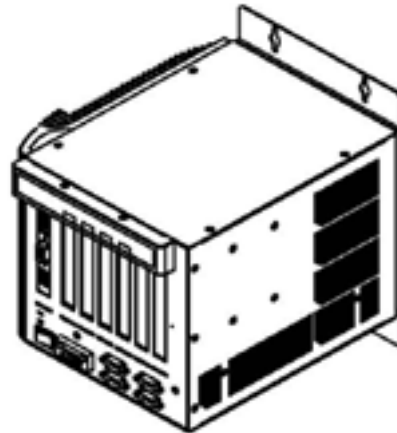
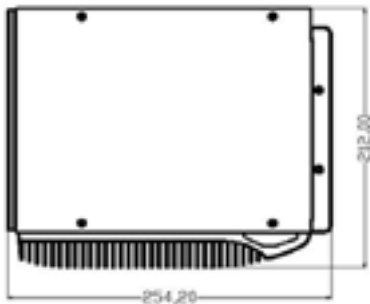

FES 8916

Fanless Embedded Controller

1.4 I/O Outlets

The following figure show you I/O outlets on front and rear panels of the FES8916.

Front Panel

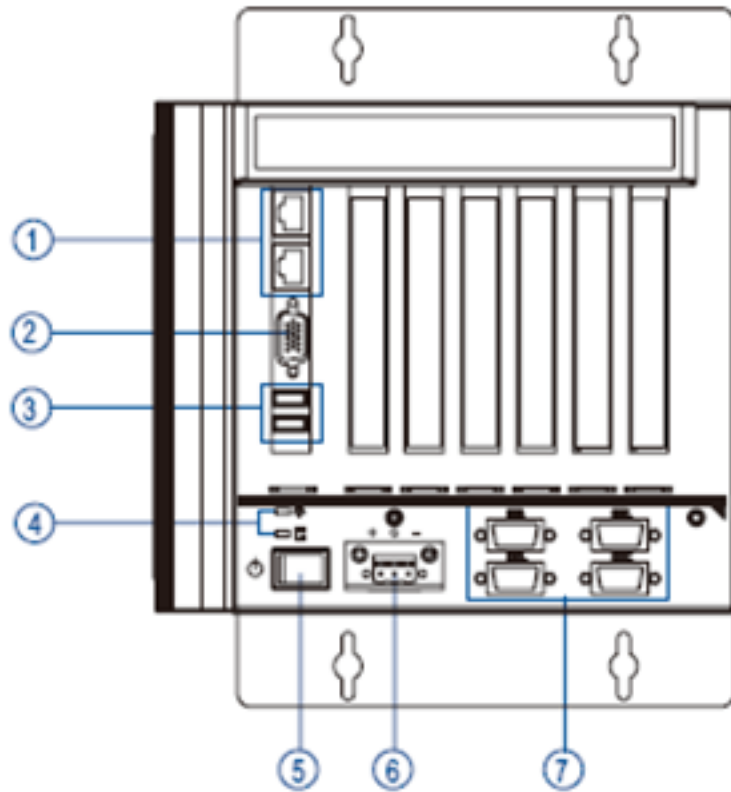

1. Ethernet x 2
2. VGA Port
3. USB 2.0 x 2
4. LED for Power & HDD
5. ATX Power Switch
6. Power Connector (AC-IN or Phoenix Plug)
7. RS-232 (COM2/3/4)
RS-232/422/485 (COM1)







FES 8916

Fanless Embedded Controller

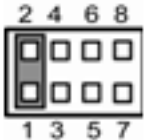
1.5 Jumper Settings

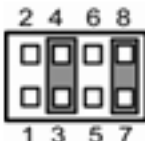
The FES8916 has a number of jumpers inside the chassis that allow you to configure your system to suit your application. The table below lists the functions of the various jumpers.

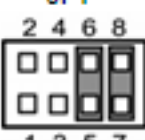
These jumpers select the COM1 port's communication mode to operate RS-232 or RS-422/485.

Description	Function	Jumper Setting		
	RS-232 (Default)			
	RS-422			
	RS-485			

FES 8916

Fanless Embedded Controller

These jumpers select the COM1, COM2 ports' DCD and RI mode.

Description	Function	Jumper Setting
COM1 DCD & RI Voltage Selection (JP6)	Pin 1=12V	
	Pin 1=5V	
	*Pin 1=DCD (Default)	
	Pin 8=12V	
	Pin 8=5V	
	*Pin 8=RI (Default)	

FES 8916



Fanless Embedded Controller

Description	Function	Jumper Setting
COM2 DCD & RI Voltage Selection (JP5)	Pin 1=12V	
	Pin 1=5V	
	*Pin 1=DCD (Default)	
	Pin 8=12V	
	Pin 8=5V	
	*Pin 8=RI (Default)	

FES 8916



Fanless Embedded Controller

CompactFlash™ Device Setting Jumper (JP8~11)

Jumper	Description	Jumper Setting	Description	Jumper Setting
CF Device	Enable (Default)		Disable	



CompactFlash™ Voltage Selection Jumper (JP12)

This jumper is to select the voltage for CompactFlash™ interface.

Description	Function	Jumper Setting
CompactFlash™ Voltage Selection	3.3V (Default)	
	5V	

CMOS Clear Jumper (JP19)

You may need to use this jumper to clear the CMOS memory if incorrect settings in the Setup Utility.



Description	Function	Jumper Setting
CMOS Clear	Normal (Default)	
	Clear CMOS	

FES 8916

Fanless Embedded Controller



USB Voltage Selection Jumpers (JP14, JP15, JP17)

This jumper is to select the voltage for USB interface.

Description	Function	Jumper Setting
USB Voltage Selection	5V	
	5V_SBY	

LVDS Voltage Selection Jumper (JP18)

This jumper is to select the voltage for LVDS interface.

Description	Function	Jumper Setting
LVDS Voltage Selection	3.3V (Default)	
	5V	

The header image features a blue background with a glowing circuit board on the left side. The text 'FES 8916' is prominently displayed in white, with 'Fanless Embedded Controller' written below it in a smaller white font.

FES 8916

Fanless Embedded Controller

1.6 Packing List

The package bundled with your FES8916 should contain the following items:

- FPC8916 Unit x 1
- 19V 150W Adapter (for FPC8916 AC Version)
- Driver CD
- Quick Manual
- Wall Mount Bracket x 2
- HD Bracket x 2
- HD Screw x 4

If you can not find this package or any items are missing, please contact Acnodes Corp. distributors immediately.

CHAPTER 2 HARDWARE INSTALLATION

The FES8916 are convenient for your various hardware configurations, such as CPU (Central Processing Unit), Memory Module, HDD (Hard Disk Drive) and PCIe card. The chapter 2 will show you how to install the hardware. It includes:

2.1 Installing the Processor

The Intel® Pentium® M Processor is available as a boxed processor for laptop computers in the micro-FCPGA form factor. Intel recommends

the processor should be installed by a computer professional since this electronic device may cause serious damage to the installer, system and processor if installed improperly.

Important Notes Before attempting to install a new processor, carefully review the documentation that came with your system and make sure that you will not be voiding your warranty by opening the computer or replacing your processor.

Instructions:

1. Make sure that your system can accommodate the Intel® Pentium® M Processor that you want to install. Check for motherboard, BIOS, and thermal compatibility by using the manufacturer's documentation for the laptop computer, or by contacting the vendor if necessary. This processor should only be installed in systems supporting the Intel® Pentium® M Processor.

Important Notes Do not use an Intel® Pentium® M Processor in a desktop system and do not use a desktop processor in an Intel® Pentium® M Processor notebook. Since these processors have different electrical specifications, damage to the processor and system can occur.

2. Obtain access to your processor socket as described in the documentation for your system.

3. If the cooling solution prevents you from accessing the processor socket, you may need to remove it. Instructions on how to remove your cooling solution should be provided in the documentation that came with the system.

4. To un-install the current processor, use a screwdriver to disengage (open) the socket actuator, as shown in Figure 1 below. (The most commonly used sockets are Molex* or FoxConn* sockets, so they are used in the illustrations below.) The socket actuator should open after only a half turn or so, and you should then be able to remove the processor with your fingers.

FES 8916

Fanless Embedded Controller

Procedure of Installation:

- Step 1** Turn off the system.
- Step 2** Disconnect the power connector.
- Step 3** Loosen screws to remove the top and side covers from the chassis.

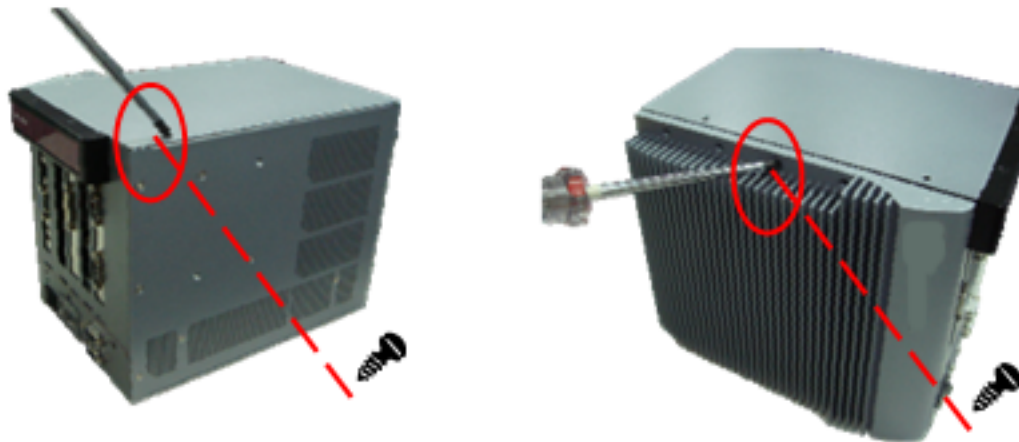

- Step 4** After opening the top and side covers, you can locate the CPU socket and heatsink as marked. Align pins of the CPU with pin holes of the socket. Be careful of the CPU's orientation that you need to align the arrow mark on the CPU with the arrow key on the socket. Place the CPU into the socket, and use a screwdriver to lock it onto the socket.



FES 8916

Fanless Embedded Controller

Step 5 Place the CPU Heatsink on the CPU, and lock it by screwdriver.



Step 7 Close the top and side covers back to the chassis, and fasten all screws.

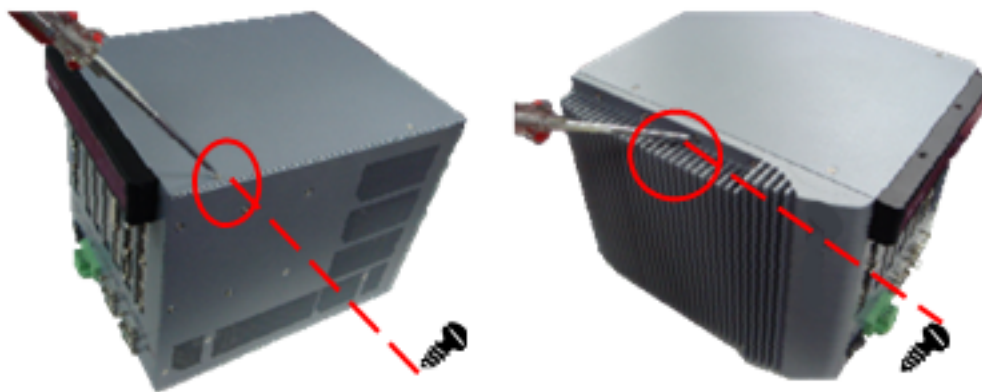

FES 8916

Fanless Embedded Controller

2.2 Installing the Memory Module

- Step 1 Turn off the system.
- Step 2 Disconnect the power connector.
- Step 3 Loosen screws to remove the side cover from the chassis.

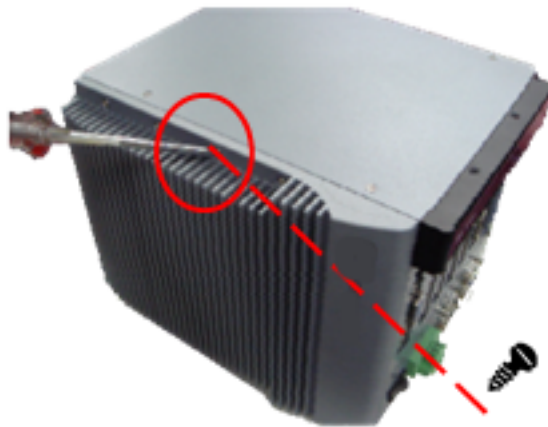

- Step 4 Please follow steps below to install the upper memory module:
 - 1. Align the memory module with the socket that notches of memory module must match the socket keys for a correct installation.

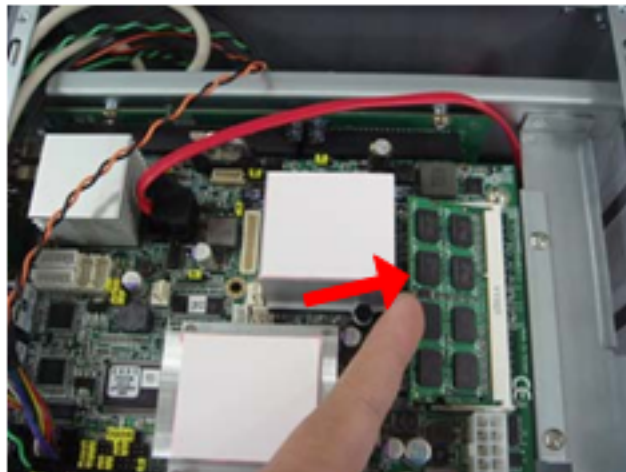

FES 8916

Fanless Embedded Controller

2. Install the memory module into the socket and push it firmly down until it is fully seated. The socket latches are clipped on to the edges of the SO-DIMM.

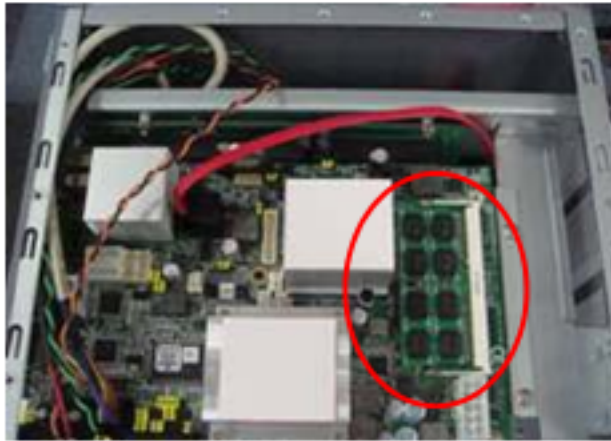

Step 5 Put back the side cover to the chassis and fasten all screws.

FES 8916

Fanless Embedded Controller

2.3 Installing the Hard Disk Drive

The FES8916 offers a convenient drive bay module for users to install HDD. The system offers users one 2.5" Hard Disk Drive for installation. Please follow the steps:

- Step 1** Turn off the system.
- Step 2** Disconnect the power connector.
- Step 3** Loosen screws to remove the top cover from the chassis.



- Step 4** Open the top cover and locate the two Hard Disk Drives from the side.



FES 8916

Fanless Embedded Controller

Step 5 Use assembly parts to fix HDD with the bracket.



Step 6 Install and fix the HDD through the bottom & side, next, plug the power cable in HDD.

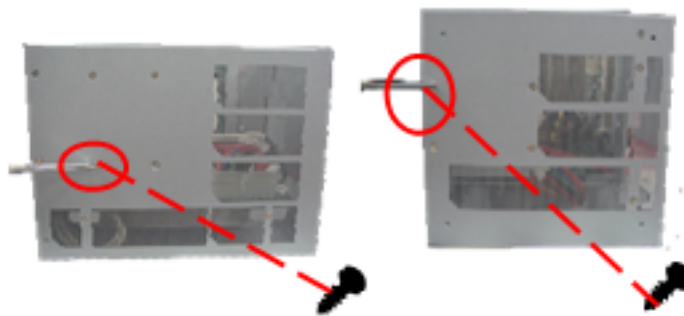

Step 7 Close the top cover back to the chassis and fasten all screws.

FES 8916

Fanless Embedded Controller

2.4 Installing the PCI Card or PCIe Card

- Step 1** Turn off the system.
- Step 2** Disconnect the power connector.
- Step 3** Loosen screws to remove the top cover from the chassis.
Removing the PCI or PCIe bracket by releasing the button as marked.

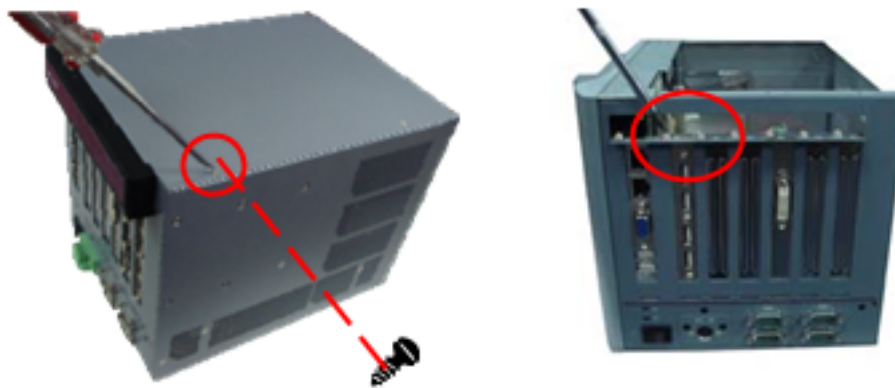

- Step 4** Locate the PCI or PCIe slots from the side.

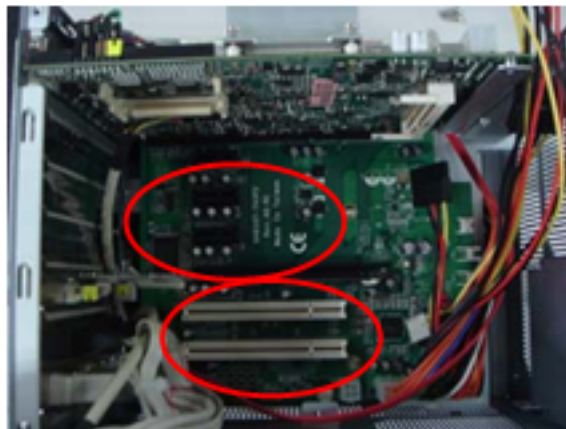

FES 8916

Fanless Embedded Controller

Step 5 Align the PCI or PCIe card with the slot, and press the card into the slot until it is firmly seated.



Step 6 Close the top cover back to the chassis and fasten all screws.

CHAPTER 3 AMI BIOS UTILITY

This chapter provides users with detailed description how to set up basic system configuration through the AMIBIOS8 BIOS setup utility.



3.1 Starting

To enter the setup screens, follow the steps below:

1. Turn on the computer and press the key immediately.

After you press the <Delete> key, the main BIOS setup menu displays. You can access the other setup screens from the main BIOS setup menu, such as the Chipset and Power menus.

3.2 Navigation Keys

 Left/Right	The Left and Right <Arrow> keys allow you to select a setup screen.
 Up/Down	The Up and Down <Arrow> keys allow you to select a setup screen or sub-screen.
 Plus/Minus	The Plus and Minus <Arrow> keys allow you to change the field value of a particular setup item.
Tab	The <Tab> key allows you to select setup fields.
F1	The <F1> key allows you to display the General Help screen.
F10	The <F10> key allows you to save any changes you have made and exit Setup. Press the <F10> key to save your changes.
Esc	The <Esc> key allows you to discard any changes you have made and exit the Setup. Press the <Esc> key to exit the setup without saving your changes.
Enter	The <Enter> key allows you to display or change the setup option listed for a particular setup item. The <Enter> key can also allow you to display the setup sub- screens.

FES 8916

Fanless Embedded Controller

3.3 The Main Menu

Once you enter the AMI BIOS CMOS Setup Utility, the Main Menu appears on the screen. In the Main Menu, there are several Setup functions and a couple of Exit options for your selection. Use arrow keys to select the Setup Page you intend to configure then press <Enter> to accept or enter its sub-menu.

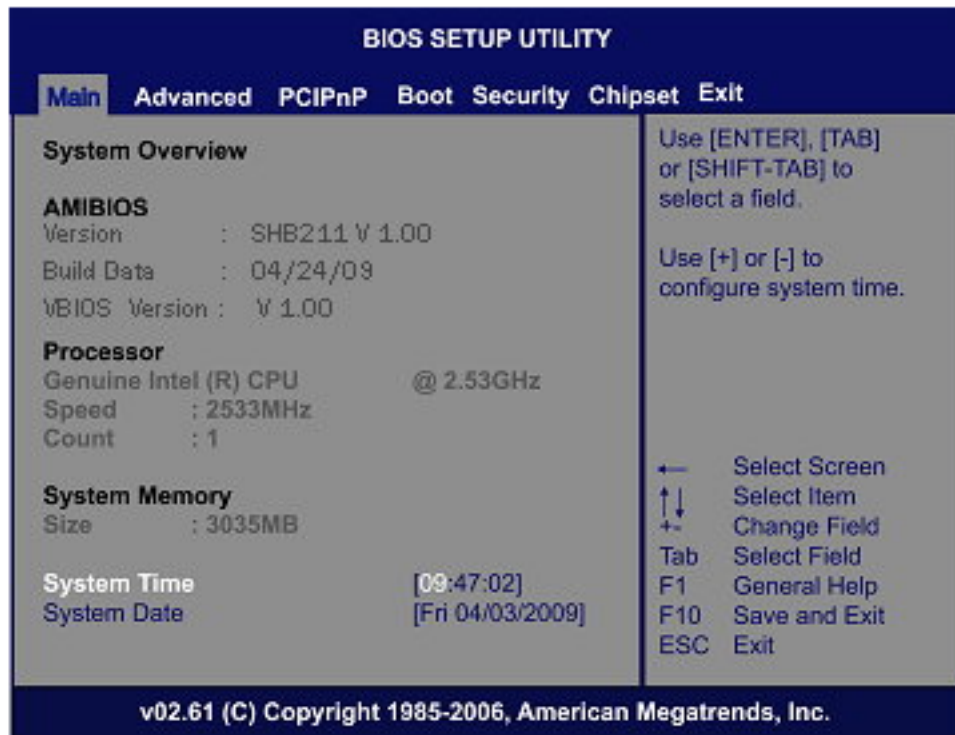

System Time/Date

Use this option to change the system time and date. Highlight System Time or System Date using the <Arrow> keys. Enter new values through the keyboard. Press the <Tab> key or the <Arrow> keys to move between fields. The date must be entered in MM/DD/YY format. The time is entered in HH:MM:SS format.

FES 8916

Fanless Embedded Controller

3.4 Advanced BIOS Features

The Advanced menu allows users to set configuration of the CPU and other system devices. You can select any of the items in the left frame of the screen to go to the sub menus:

- ▣ CPU Configuration
- ▣ IDE Configuration
- ▣ Floppy Configuration
- ▣ SuperIO Configuration
- ▣ Hardware Health Configuration
- ▣ ACPI Configuration
- ▣ AHCI Configuration
- ▣ APM Configuration
- ▣ Event Log Configuration
- ▣ Intel VT-d Configuration
- ▣ Smbios Configuration
- ▣ USB Configuration

For items marked with "£", please press <Enter> for more options.

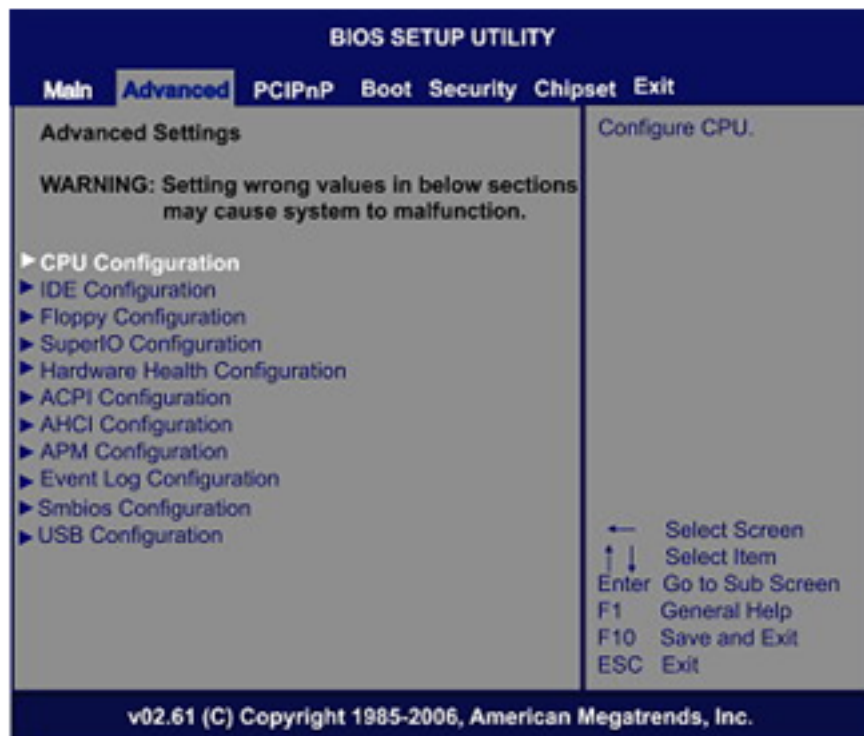

FES 8916

Fanless Embedded Controller

≡ CPU Configuration

This screen shows the CPU Configuration, and you can change the value of the selected option this section allows you to configure and improve your system, to set up some system features according to your preference.

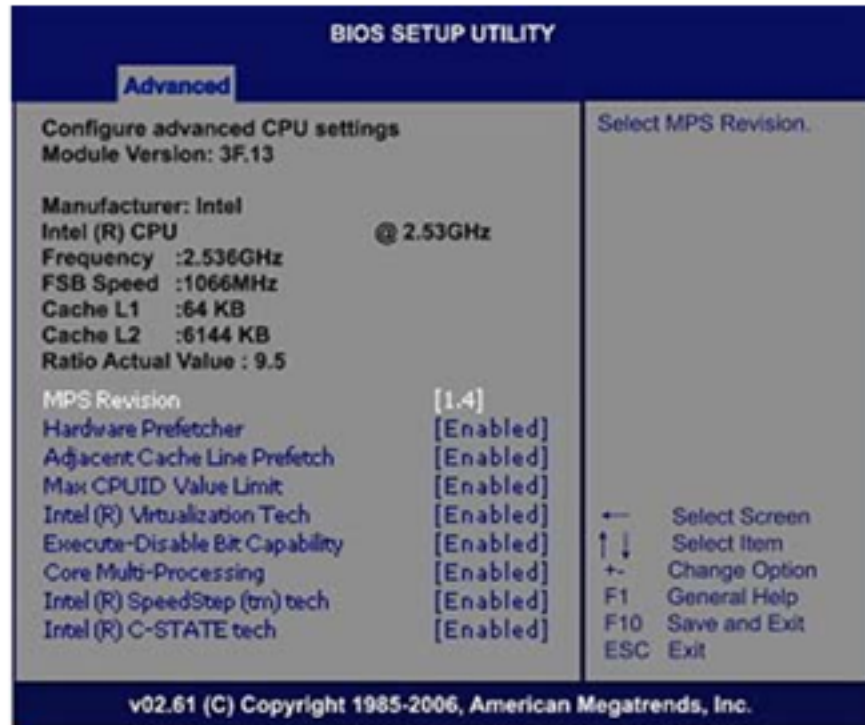

FES 8916

Fanless Embedded Controller

≡ CPU Feature

Scroll to this item and press <Enter> to view the CPU Feature sub menu.

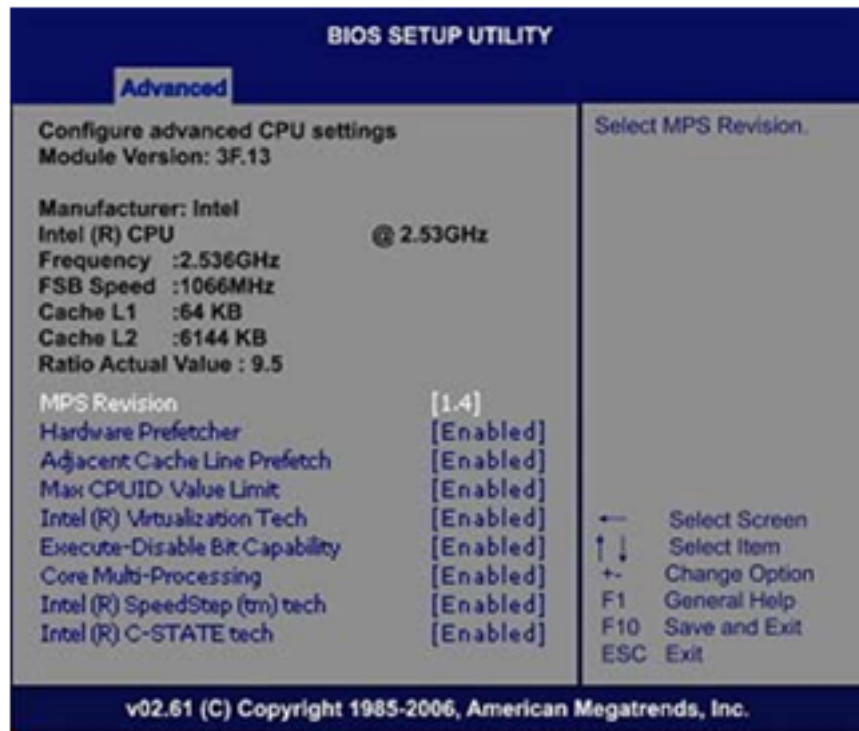

- ⊙ **MPS Revision**
Use this item to select MPS (Multi Processor Specification) Revision 1.1 or 1.4. The default setting is 1.4.
- ⊙ **Hardware Prefetcher**
This item automatically analyzes its requirements and prefetches data and instructions from the memory. When enabled, the processor's hardware prefetcher will be allowed to automatically prefetch data and code for the processor.
- ⊙ **Adjacent Cache Line Prefetch**
This item has a hardware adjacent cache line prefetch mechanism that automatically fetches extra cache line whenever the processor requests for a cache line. This reduces cache latency by making the next cache line immediately available if the processor requires it as well. The processor will retrieve the currently requested cache



FES 8916

Fanless Embedded Controller

line and the subsequent cache line when enabled.

The processor will only retrieve the currently requested cache line when disabled.

⊗ **Max CPUID Value Limit**

You can enable this item to let legacy operating systems boot even without support for CPUs with extended CPU ID functions.

⊗ **Intel (R) Virtualization Tech**

Use this feature to enable or disable the Intel Virtualization Technology (IVT) extensions, which allow multiple operating systems to run simultaneously on the same system.

When the IVT extensions are enabled, it allows for hardware-assisted virtual machine management.

⊗ **Execute-Disable Bit Capability**

This item helps you enable or disable the No-Execution Page Protection Technology.

⊗ **Core Multi-Processing**

This feature controls the functionality of the Core Multi-Processing to allow the processor to execute multitasking function.

⊗ **Intel (R) SpeedStep (tm) tech**

This item helps you enable or disable the Intel SpeedStep Technology.

⊗ **Intel (R) C-STATE tech**

Use this item to enable or disable the C-State technology.

FES 8916

Fanless Embedded Controller

≡ IDE Configuration

You can use this screen to select options for the IDE Configuration, and change the value of the selected option. A description of the selected item appears on the right side of the screen. For items marked with "⌵", please press <Enter> for more options.

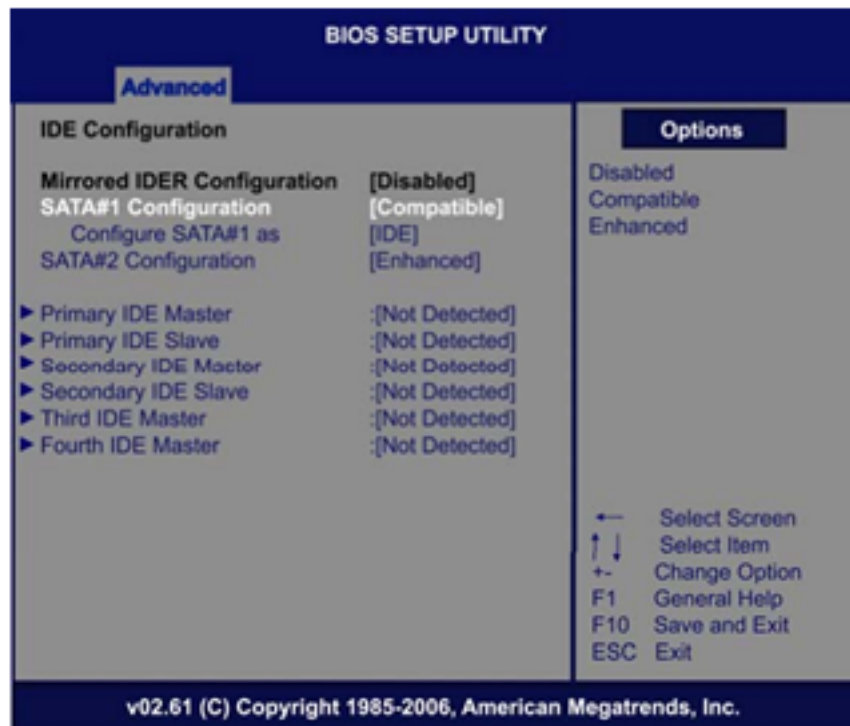

- ⊙ **SATA#1 Configuration**
Use this item to control the onboard SATA controller. Here are the options for your selection, *Compatible*, *Disabled*, and *Enhanced*.
- ⊙ **Configure SATA#1 as**
Use this item to choose the SATA operation mode. Here are the options for your selection, *IDE* and *AHCI*.
- ⊙ **SATA#2 Configuration**
Use this item to control the onboard SATA controller. Here are the options for your selection, *Enhanced* and *Disabled*.
- ⊙ **Primary/Secondary/Third/Fourth IDE Master/Slave**
Select one of the hard disk drives to configure IDE devices installed in the system by pressing <Enter> for more options.

FES 8916

Fanless Embedded Controller

☰ Floppy Configuration

You can use this screen to select options for the Floppy Configuration, and change the value of the selected option. A description of the selected item appears on the right side of the screen. For items marked with "Ⓢ", please press <Enter> for more options.

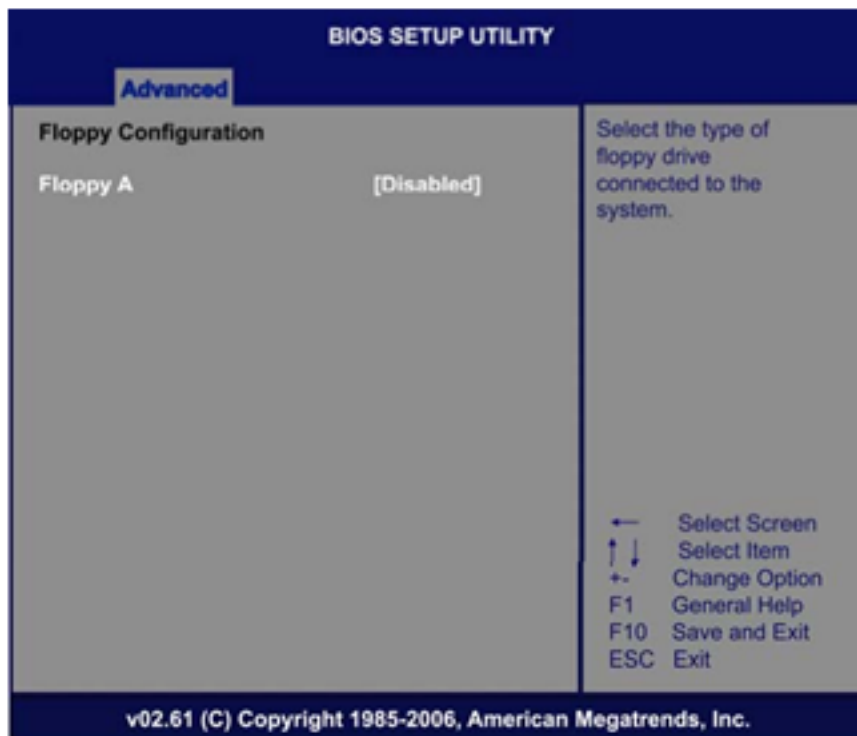

Ⓢ Floppy A

This item selects the type of floppy disk installed in the computer.

FES 8916

Fanless Embedded Controller

≡ SuperIO Configuration

You can use this screen to select options for the SuperIO Configuration, and change the value of the selected option. A description of the selected item appears on the right side of the screen.

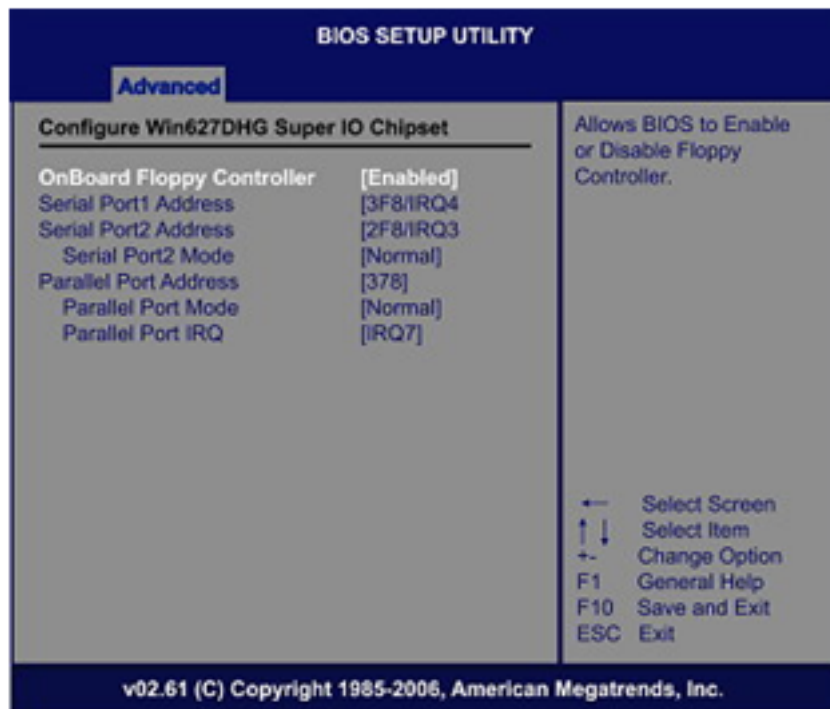

- ⊙ **OnBoard Floppy Controller**
Use this item to enable or disable the onboard floppy drive controller.
- ⊙ **Serial Port1 Address**
This option specifies the base I/O port address and Interrupt Request address of serial port 1. The Optimal setting is 3F8/IRQ4. The Fail-Safe default setting is *Disabled*.
- ⊙ **Serial Port2 Address**
This option specifies the base I/O port address and Interrupt Request address of serial port 2. The Optimal setting is 2F8/IRQ3. The Fail-Safe setting is *Disabled*.
- ⊙ **Serial Port2 Mode**
This item specifies the mode used by the serial port 2.

FES 8916

Fanless Embedded Controller

- ⊙ **Parallel Port Address**
Select an operating mode for the onboard parallel (printer) port.
- ⊙ **Parallel Port IRQ**
Use this item to set up the IRQ for onboard parallel port.

≡ Hardware Health Configuration

This screen shows the Hardware Health Configuration, and a description of the selected item appears on the right side of the screen

BIOS SETUP UTILITY	
Advanced	
Hardware Health Configuration	Fan configuration mode setting
SYS Temperature	:46°C/114°F
CPU Temperature	:46°C/114°F
VTIM Temperature	:49°C/120°F
CPUFAN0 Speed	:7001 RPM
SYSFAN0 Speed	:7004 RPM
Vcore	:1.144 V
VIN1	:3.3444 V
VIN2	:11.776 V
VIN3	:5.084 V
SYSFAN Mode Setting	[Manual Mode]
CPUFAN0 Mode Setting	[Manual Mode]
AUXFAN Mode Setting	[Manual Mode]
	← Select Screen
	↑ ↓ Select Item
	+ - Change Option
	F1 General Help
	F10 Save and Exit
	ESC Exit
v02.61 (C) Copyright 1985-2006, American Megatrends, Inc.	

- ⊙ **H/W Health Function**
You can select this item *Enabled* for the Hardware Health Monitoring Device. The Hardware Health Event Monitoring displays the temperature of CPU and System, Fan Speed, Vcore, etc.
- ⊙ **SYSFAN/CPUFAN/AUXFAN Mode Setting**
These items can enable or disable the Smart Fan to adjust the CPU/system fan speed automatically in accordance with the current CPU temperature that can prevent the system overheating. There are these options *Manual Mode* and *Thermal Cruise Mode*.

FES 8916

Fanless Embedded Controller

≡ ACPI Configuration

You can use this screen to select options for the ACPI Configuration, and change the value of the selected option. A description of the selected item appears on the right side of the screen.

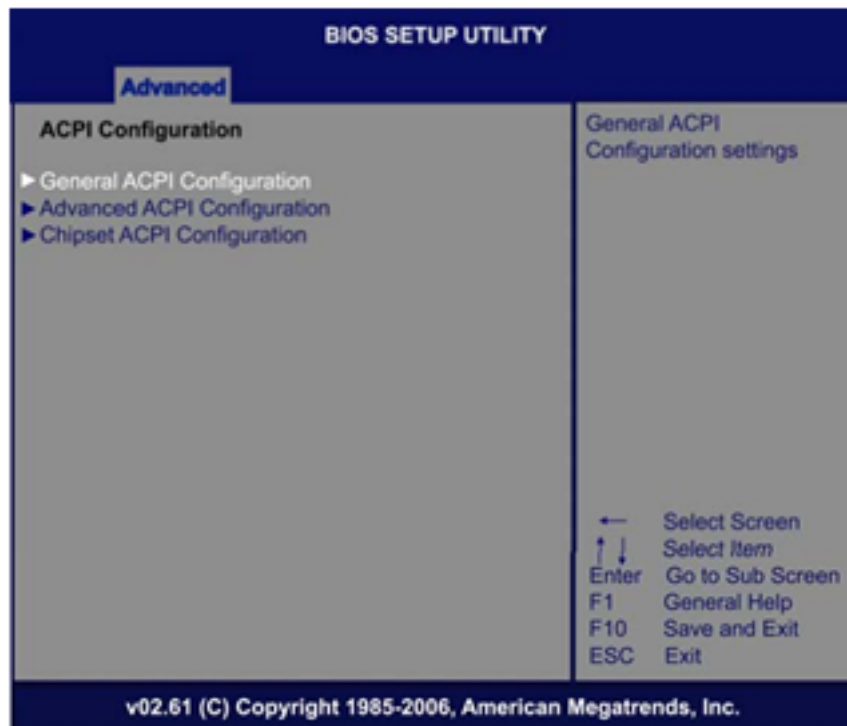

- ⊙ **General ACPI Configuration**
Scroll to this item and press <Enter> to view the General ACPI Configuration sub menu, which contains General ACPI (Advanced Configuration and Power Management Interface) options for your configuration.
- ⊙ **Advanced ACPI Configuration**
Scroll to this item and press <Enter> to view the Advanced ACPI Configuration sub menu, which contains Advanced ACPI (Advanced Configuration and Power Management Interface) options for your configuration.
- ⊙ **Chipset ACPI Configuration**
Scroll to this item and press <Enter> to view the Chipset ACPI Configuration sub menu, which contains Chipset ACPI (Advanced Configuration and Power Management Interface) options for your configuration.

FES 8916

Fanless Embedded Controller

≡ AHCI Configuration

You can use this screen to select options for the AHCI Configuration, and change the value of the selected option. A description of the selected item appears on the right side of the screen.

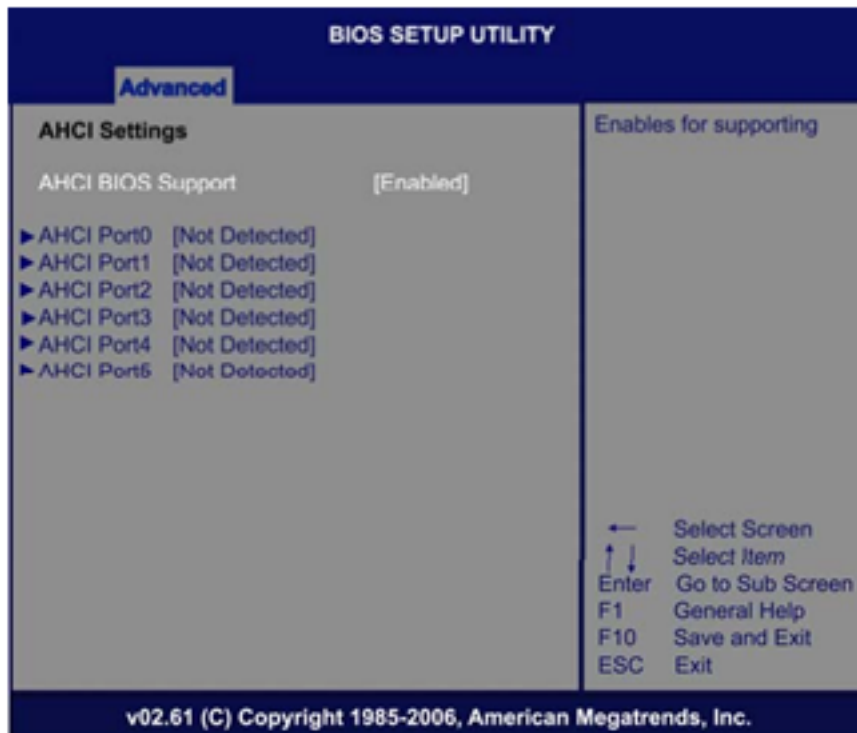

⊙ AHCI BIOS Support

You can enable or disable this item to control the AHCI function of the SATA controller.

FES 8916

Fanless Embedded Controller

≡ APM Configuration

You can use this screen to select options for the APM Configuration, and change the value of the selected option. A description of the selected item appears on the right side of the screen.

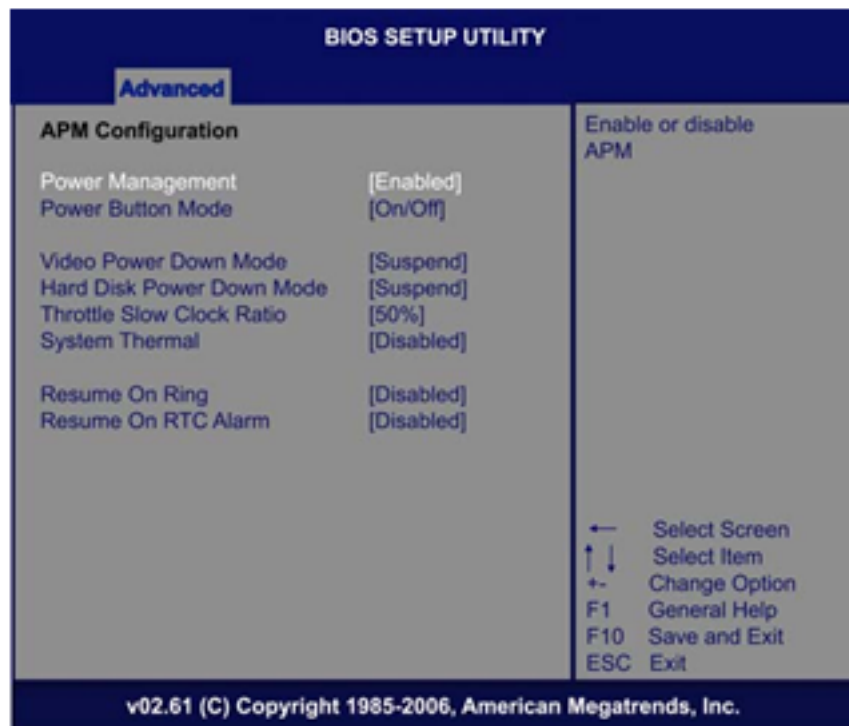

⊙ Power Management

Set this value to allow Power Management/APM support. The default setting is *Enabled*.

Disabled	Set this value to prevent the chipset power management and APM (Advanced Power Management) features.
Enabled	Set this value to allow the chipset power management and APM (Advanced Power Management) features. This is the default setting.

FES 8916

Fanless Embedded Controller

⊙ Power Button Mode

This option specifies how the externally mounted power button on the front of the computer chassis is used. The default setting is *On/Off*.

On/Off	Pushing the power button turns the computer on or off. This is the default setting. This is the default setting.
Standby	Pushing the power button places the computer in Standby mode.
Suspend	Pushing the power button places the computer in Suspend mode or Full On power mode.

⊙ Video Power Down Mode

This option specifies the Power State that the video subsystem enters when the BIOS places it in a power saving state after the specified period of display inactivity has expired. The default setting is *Suspend*.

Disabled	This setting prevents the BIOS from initiating any power saving modes concerned with the video display or monitor.
Standby	This option places the monitor into standby mode after the specified period of display inactivity has expired. This means the monitor is not off. The screen will appear blacked out. The standards do not cite specific power ratings because they vary from monitor to monitor.
Suspend	This option places the monitor into suspend mode after the specified period of display inactivity has expired. This means the monitor is not off. The screen will appear blacked out. The standards do not cite specific power ratings because they vary from monitor to monitor, but this setting use less power than Standby mode. This is the default setting.

⊙ Hard Disk Drive Power Down Mode

This option specifies the power conserving state that the hard disk drive enters after the specified period of hard drive inactivity has expired. The default setting is *Suspend*.

Disabled	This setting prevents hard disk drive power down mode.
----------	--

FES 8916

Fanless Embedded Controller

Standby	This option stops the hard disk drives from spinning during a system standby.
Suspend	This option cuts the power to the hard disk drives during a system suspend. This is the default setting.

- ⊗ **Throttle Slow Clock Ratio**
Use this item to specify the speed of the system clock when running the power saving states.
- ⊗ **System Thermal**
Use this item to enable or disable the function of system temperature control.
- ⊗ **Resume On Ring**
This item enables or disables the function of Resume on Ring that resume the system through incoming calls.
- ⊗ **Resume On RTC Alarm**
You can set "Resume On RTC Alarm" item to enabled and key in Data/time to power on system.

FES 8916

Fanless Embedded Controller

≡ Event Log Configuration

This screen shows the Event Log Configuration, and a description of the selected item appears on the right side of the screen.

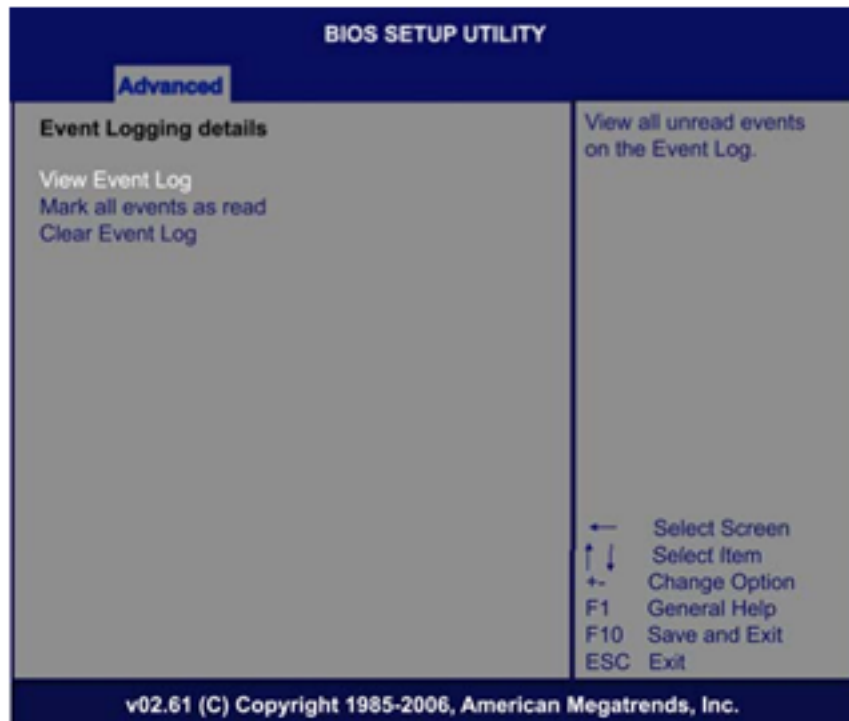

- ⊙ **View Event Log**
This item is to display the system events in the System Event Log.
- ⊙ **Mark all events as read**
This item is to mark all events in the log as read.
- ⊙ **Clear Event Log**
Enable this item is to clear the event log each time the system is rebooted.

FES 8916

Fanless Embedded Controller

III Smbios Configuration

You can use this screen to select options for the Smbios Configuration, and change the value of the selected option. A description of the selected item appears on the right side of the screen.

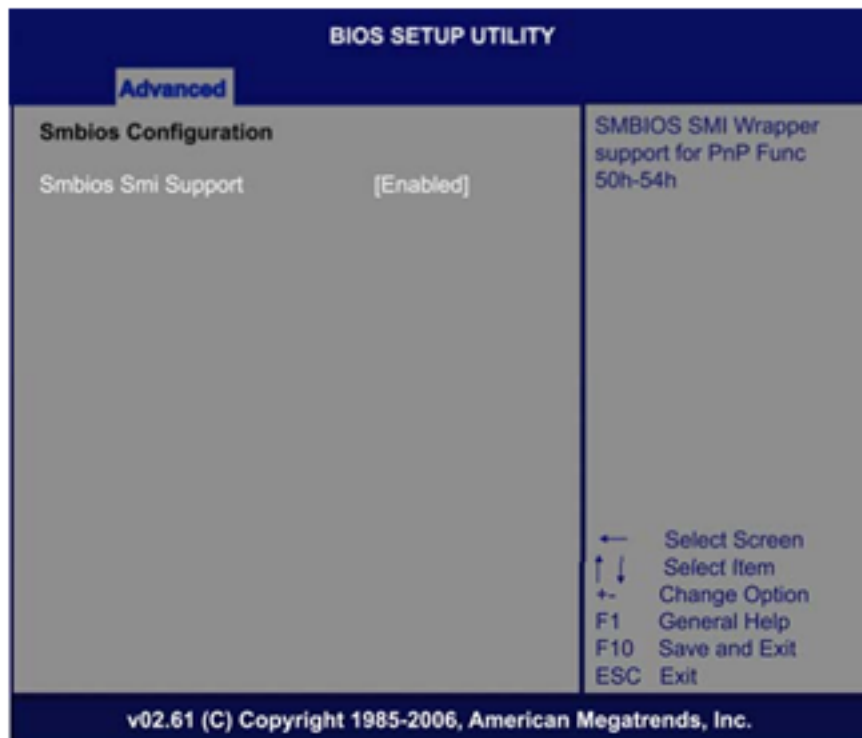

⊙ Smbios Smi Support

When this item is enabled, the system can support the SMBIOS SMI wrapper for the PnP.

FES 8916

Fanless Embedded Controller

≡ USB Configuration

You can use this screen to select options for the USB Configuration, and change the value of the selected option. A description of the selected item appears on the right side of the screen.

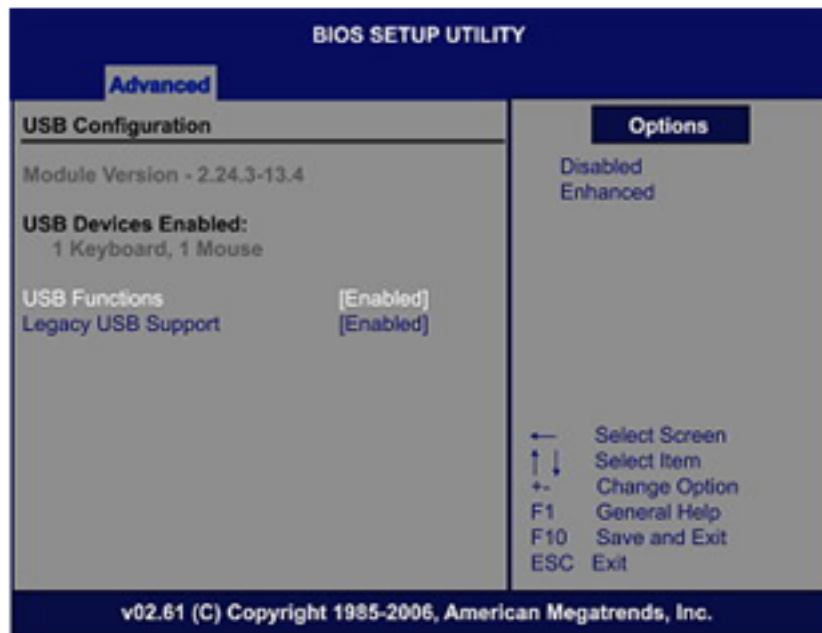

⊗ USB Functions

This item allows you to enable or disable USB functions.

⊗ Legacy USB Support

Use this item to enable or disable support for USB device on legacy operating system. The default setting is Enabled

FES 8916

Fanless Embedded Controller

3.5 PCIPnP Menu

The PCI PnP menu allows users to change the advanced settings for PCI/PnP devices.

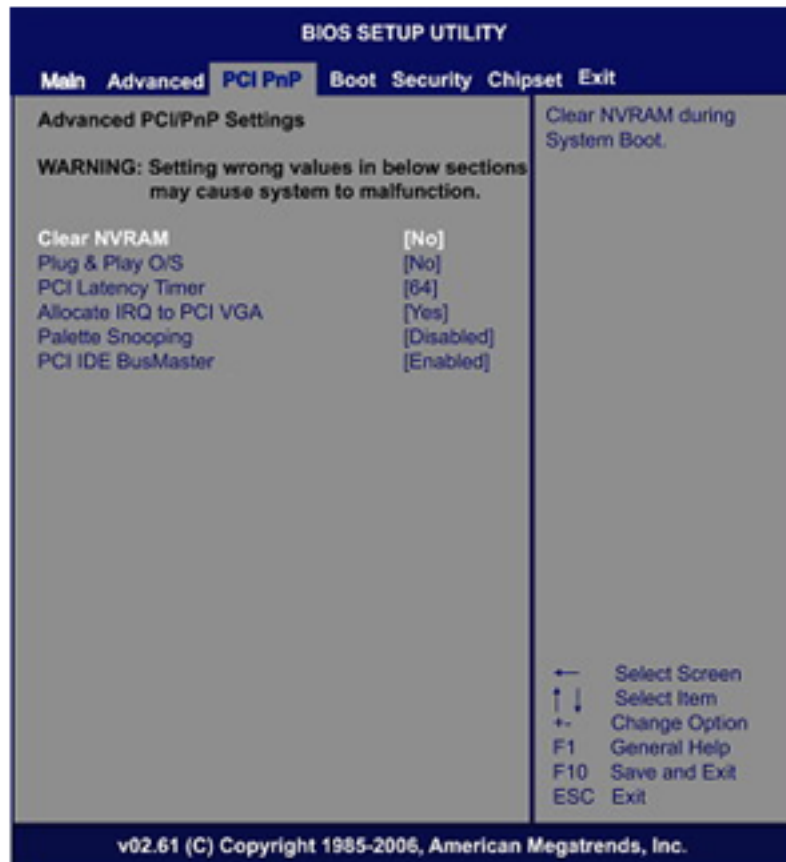

- ⊙ **Clear NVRAM**
Use this item to clear the data in the NVRAM (CMOS). Here are the options for your selection, No and Yes.
- ⊙ **Plug & Play O/S**
When the setting is No, Use this item to configure all the devices in the system. When the setting is Yes and if you install a Plug and Play operating system, the operating system configures the Plug and Play devices not required for boot. The default setting is No.
- ⊙ **PCI Latency Timer**
This item controls how long a PCI device can hold the PCI bus before another takes over. The longer the latency, the



FES 8916

Fanless Embedded Controller

longer the PCI device can retain control of the bus before handing it over to another PCI device. There are several options for your selection.

- ② **Allocate IRQ to PCI VGA**
This item allows BIOS to choose an IRQ to assign for the PCI VGA card. Here are the options for your selection, *No* and *Yes*.
- ② **Palette Snooping**
Some old graphic controllers need to “snoop” on the VGA palette, and then map it to their display as a way to provide boot information and VGA compatibility. This item allows such snooping to take place. Here are the options for your selection, *Disabled* and *Enabled*.
- ② **PCI IDE BusMaster**
This item is a toggle for the built-in driver that allows the onboard IDE controller to perform DMA (Direct Memory Access) transfer. Here are the options for your selection, *Disabled* and *Enabled*.
- ② **OffBoard PCI/ISA IDE Card**
This item is for any other non-onboard PCI/ISA IDE controller adapter. There are several options for your selection.
- ② **IRQ3/4/5/7/9/10/11/14/15**
These items will allow you to assign each system interrupt a type, depending on the type of device using the interrupt. The option “Available” means the IRQ is going to assign automatically. Here are the options for your selection, *Available* and *Reserved*.
- ② **DMA Channel 0/1/3/5/6/7**
These items will allow you to assign each DMA channel a type, depending on the type of device using the channel. The option “Available” means the channel is going to assign automatically. Here are the options for your selection, *Available* and *Reserved*.

FES 8916

Fanless Embedded Controller

3.6 BootMenu

The Boot menu allows users to change boot options of the system. You can select any of the items in the left frame of the screen to go to the sub menus:

- ▶ Boot Settings Configuration

For items marked with "▶", please press <Enter> for more options.

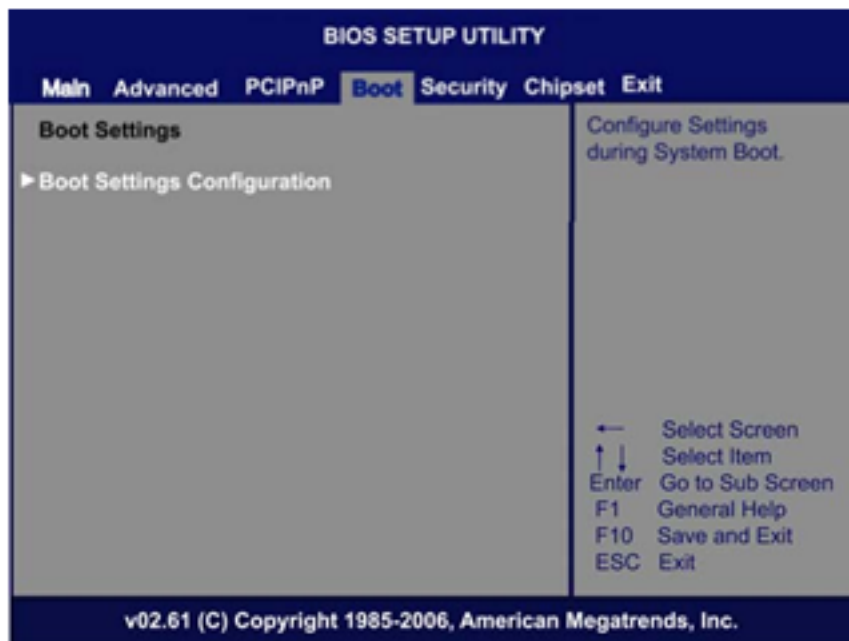

FES 8916

Fanless Embedded Controller

☰ Boot Settings Configuration

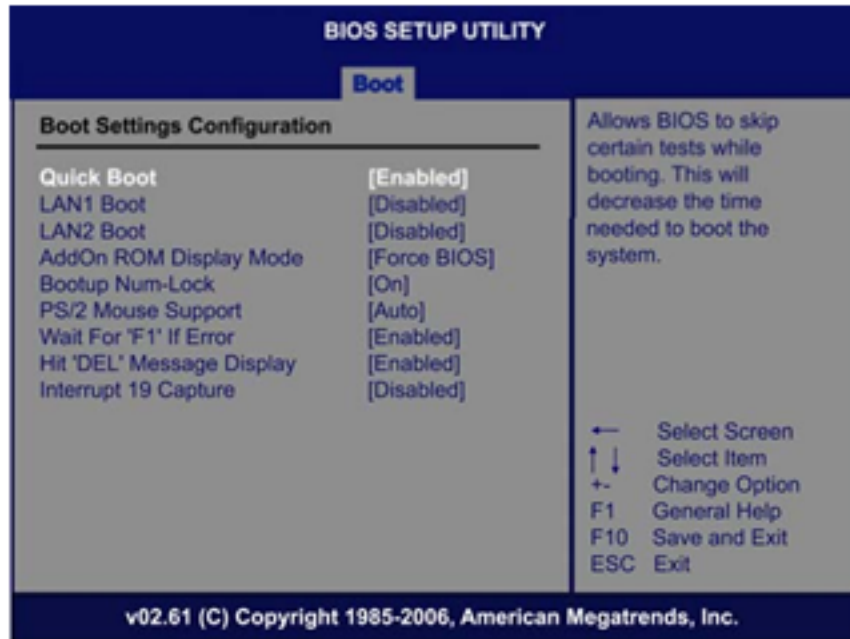

- ⊙ **Quick Boot**
Enabling this item lets the BIOS skip some power on self tests (POST). The default setting is *Enabled*.
- ⊙ **LAN1/LAN2 Boot**
Use these items to enable or disable the Boot ROM function of the onboard LAN chip when the system boots up.
- ⊙ **AddOn ROM Display Mode**
This item selects the display mode for option ROM. The default setting is *Force BIOS*.
- ⊙ **Boot Num-Lock**
Use this item to select the power-on state for the NumLock. The default setting is *On*.
- ⊙ **Wait For 'F1' Of Error**
If this item is enabled, the system waits for the F1 key to be pressed when error occurs. The default setting is *Enabled*.
- ⊙ **Hit 'DEL' Message Display**
If this item is enabled, the system displays the message "Press DEL to run Setup" during POST. The default setting is *Enabled*.



FES 8916

Fanless Embedded Controller

is Enabled.

⊙ **Interrupt 19 Capture**

If this item is enabled, this function makes the option ROMs to trap Interrupt 19. The default setting is Disabled.

FES 8916

Fanless Embedded Controller

3.7 Security Menu

The Security menu allows users to change the security settings for the system.

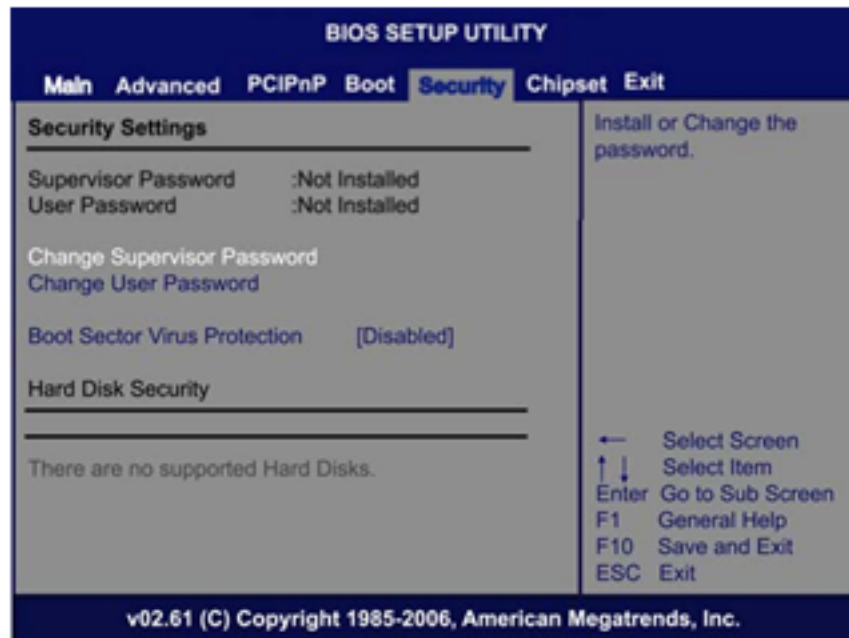

- ⊙ **Supervisor Password**
This item indicates whether a supervisor password has been set. If the password has been installed, Installed displays. If not, Not Installed displays.
- ⊙ **User Password**
This item indicates whether a user password has been set. If the password has been installed, Installed displays. If not, Not Installed displays.
- ⊙ **Change Supervisor Password**
Select this option and press <Enter> to access the sub menu. You can use the sub menu to change the supervisor password.
- ⊙ **Change User Password**
Select this option and press <Enter> to access the sub menu. You can use the sub menu to change the user password.

FES 8916

Fanless Embedded Controller

⊙ **Boot Sector Virus Protection**

This option is near the bottom of the Security Setup screen.
The default setting is *Disabled*

Disabled	Set this value to prevent the Boot Sector Virus Protection. This is the default setting.
Enabled	Select Enabled to enable boot sector protection. It displays a warning when any program (or virus) issues a Disk Format command or attempts to write to the boot sector of the hard disk drive. If enabled, the following appears when a write is attempted to the boot sector. You may have to type N several times to prevent the boot sector write. Boot Sector Write! Possible VIRUS: Continue (Y/N)? _ The following appears after any attempt to format any cylinder, head, or sector of any hard disk drive via the BIOS INT 13 Hard disk drive Service: Format!!! Possible VIRUS: Continue (Y/N)?

FES 8916

Fanless Embedded Controller

☰ Chipset Menu

The Chipset menu allows users to change the advanced chipset settings. You can select any of the items in the left frame of the screen to go to the sub menus:

- ☐ North Bridge Configuration
- ☐ South Bridge Configuration

For items marked with "☐", please press <Enter> for more options.

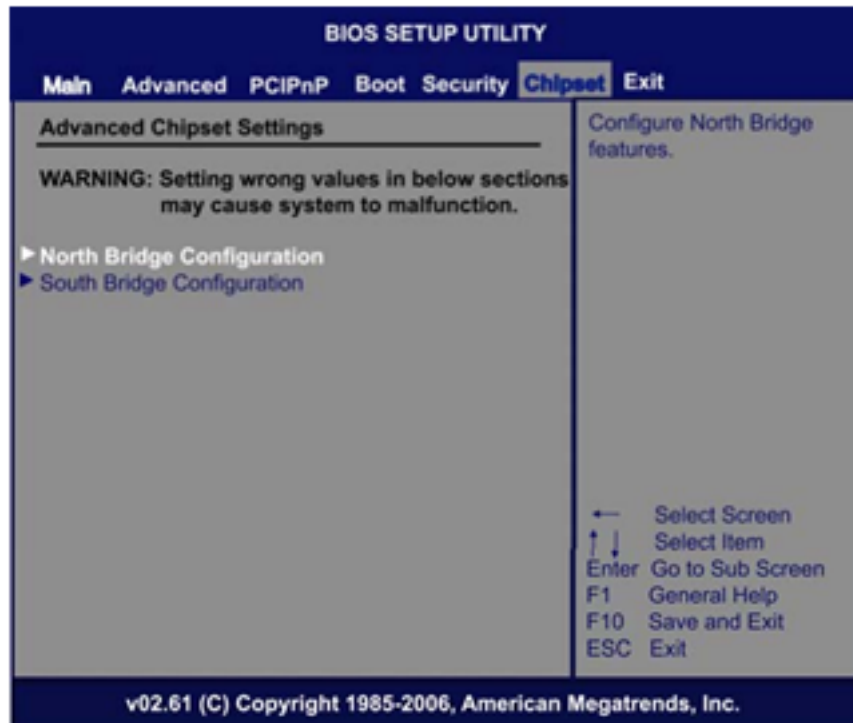

FES 8916

Fanless Embedded Controller

☰ North Bridge Configuration

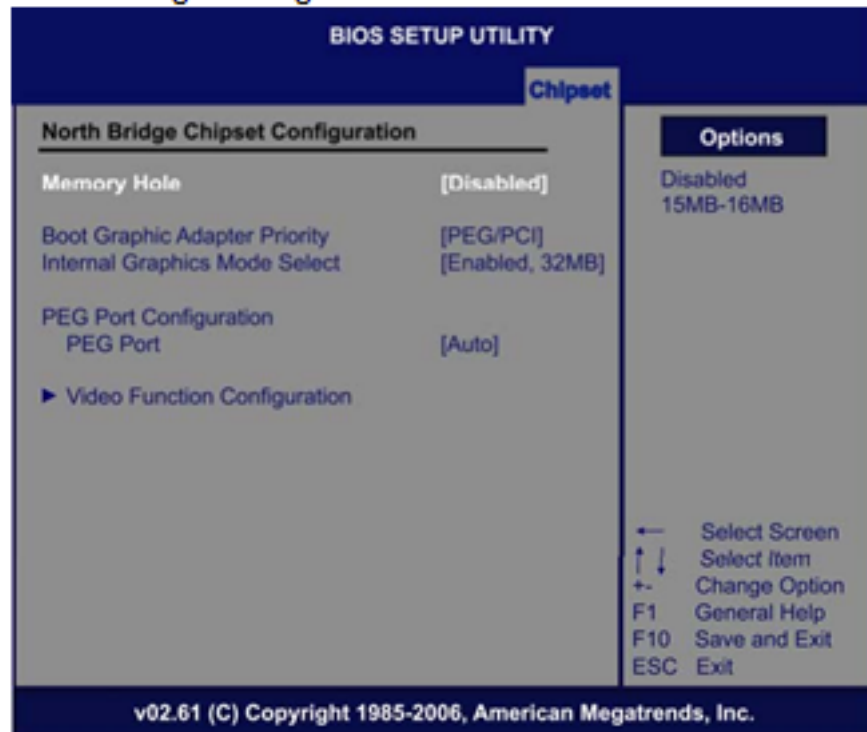

- ⊙ **Memory Hole**
You can reserve this area of system memory for ISA adapter ROM. When this area is reserved it cannot be cached. Check the user information of peripherals that need to use this area of system memory for the memory requirements. Here are the options, *Disabled* and *15M-16M*.
- ⊙ **Boot Graphic Adapter Priority**
This item allows you to select the graphics controller as the primary boot device.
- ⊙ **Internal Graphics Mode Select**
This item allows you to select the amount of system memory used by the internal graphics device.
- ⊙ **PEG Port Configuration/PEG Port**
This item is a toggle to enable or disable the PCI Express port. Here are the options for your selection, *Auto* and *Disabled*.

FES 8916

Fanless Embedded Controller

⊙ Video Function Configuration

You can press <Enter> for the sub-menu to set up video function.

☰ South Bridge Configuration



⊙ USB Controller

This item allows you to enable or disable USB function/controller.

⊙ Restore on AC Power Loss

This item can control how the PC will behave once power is restored following a power outage, or other unexpected shutdown.

⊙ PCIe Port Configuration This item can control how the PC will behave once power is restored following a power outage, or other unexpected shutdown.

FES 8916

Fanless Embedded Controller

3.8 EXIT Menu

The Exit menu allows users to load your system configuration with optimal or failsafe default values.

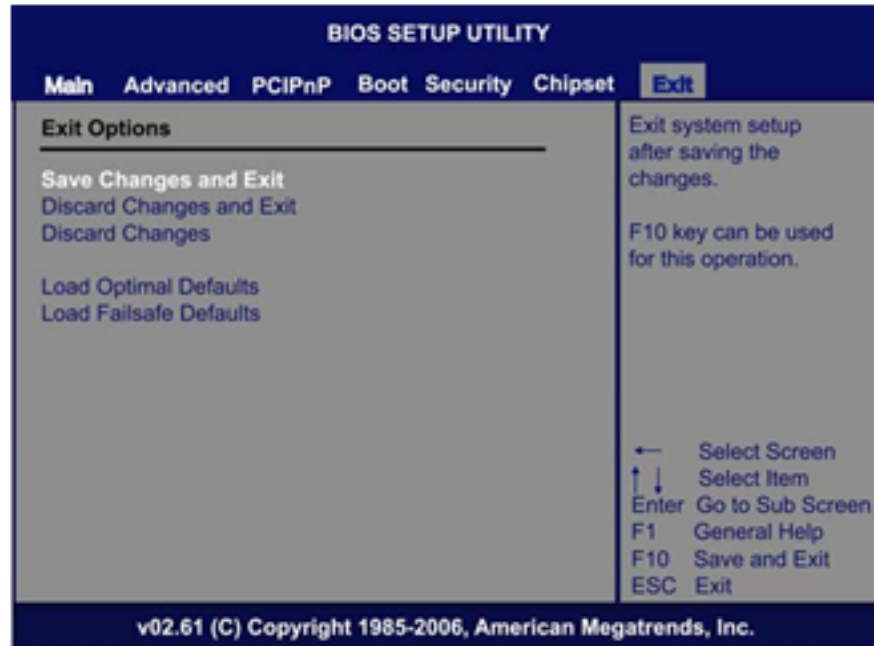

- ② **Save Changes and Exit**
When you have completed the system configuration changes, select this option to leave Setup and reboot the computer so the new system configuration parameters can take effect. Select *Save Changes and Exit* from the Exit menu and press <Enter>. Select Ok to save changes and exit.
- ② **Discard Changes and Exit**
Select this option to quit Setup without making any permanent changes to the system configuration. Select *Discard Changes and Exit* from the Exit menu and press <Enter>. Select Ok to discard changes and exit.
- ② **Discard Changes**
Use this item to abandon all changes.
- ② **Load Optimal Defaults**
It automatically sets all Setup options to a complete set of default settings when you select this option. The Optimal settings are designed for maximum system performance,



FES 8916

Fanless Embedded Controller

but may not work best for all computer applications. In particular, do not use the Optimal Setup options if your computer is experiencing system configuration problems. Select Load Optimal Defaults from the Exit menu and press <Enter>.

⊙ **Load Fail-Safe Defaults**

It automatically sets all Setup options to a complete set of default settings when you select this option. The Fail-Safe settings are designed for maximum system stability, but not maximum performance. Select the Fail-Safe Setup options if your computer is experiencing system configuration problems. Select Load Fail-Safe Defaults from the Exit menu and press <Enter>. Select Ok to load Fail-Safe defaults.