

Memorex[®]

Is it live or is it Memorex?[™]

MKS2420

User's Guide

Portable CD/CD+G
Karaoke System
with Cassette Recorder

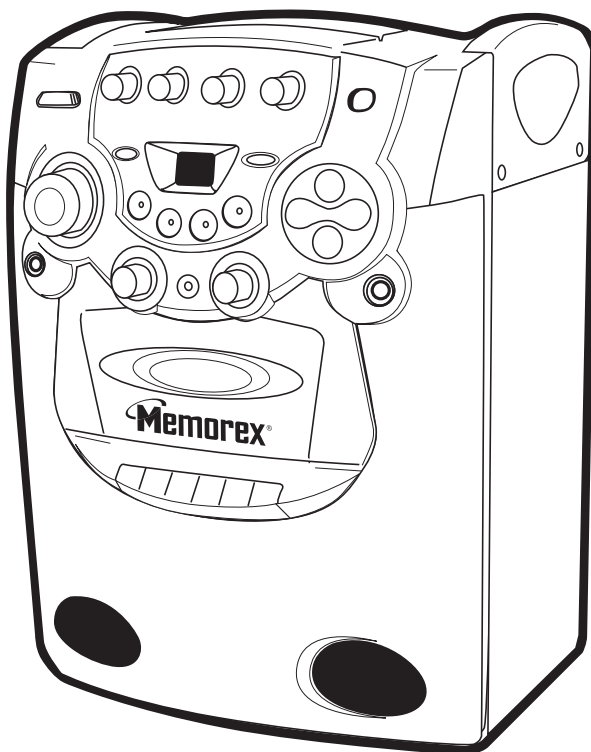

**Before operating this product,
please read these instructions completely.**



Dear Customer,

Please read this manual thoroughly before operating the unit to become more familiar with it and obtain the performance that will bring you continued enjoyment for many years. Keep these instructions handy for future reference.

PLEASE KEEP ALL PACKAGING MATERIAL FOR AT LEAST 90 DAYS IN CASE YOU NEED TO RETURN THIS PRODUCT TO YOUR PLACE OF PURCHASE OR MEMOREX.

For future reference, record the serial number of the unit printed on the rear of the cabinet.

Serial Number _____

	CAUTION RISK OF ELECTRIC SHOCK DO NOT OPEN	
CAUTION: TO REDUCE THE RISK OF ELECTRIC SHOCK, DO NOT REMOVE COVER (OR BACK). NO USER-SERVICEABLE PARTS INSIDE. REFER SERVICING TO QUALIFIED SERVICE PERSONNEL.		

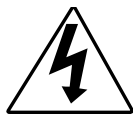

DANGEROUS VOLTAGE:
The lightning flash with arrowhead symbol, within an equilateral triangle is intended to alert the user to the presence of uninsulated dangerous voltage within the product's enclosure that may be of sufficient magnitude to constitute a risk of electric shock to persons.



ATTENTION:
The exclamation point within an equilateral triangle is intended to alert the user to the presence of important operating and maintenance (servicing) instructions in the literature accompanying the appliance.

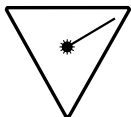

DANGER:
Invisible and hazardous laser radiation when open and interlock failed or defeated. Avoid direct exposure to beam.

FCC WARNING:
This equipment may generate or use radio frequency energy. Changes or modifications to this equipment may cause harmful interference unless the modifications are expressly approved in the instruction manual. The user could lose the authority to operate this equipment if an unauthorized change or modification is made.

LASER SAFETY: This unit employs a laser. Only qualified service personnel should attempt to service this device due to possible eye injury.
CAUTION: USE OF CONTROLS, ADJUSTMENTS OR PERFORMANCE PROCEDURE HEREIN MAY RESULT IN HAZARDOUS RADIATION EXPOSURE.

INFORMATION
This equipment has been tested and found to comply with the limits for a Class B digital device, pursuant to Part 15 of the FCC Rules. These limits are designed to provide reasonable protection against harmful interference in a residential installation. This equipment generates, uses, and can radiate radio frequency energy and, if not installed and used in accordance with the instructions, may cause harmful interference to radio communications. However, there is no guarantee that interference will not occur in a particular installation. If this equipment does cause harmful interference to radio or television reception, which can be determined by turning the equipment off and on, the user is encouraged to try to correct the interference by one or more of the following measures:

- Reorient or relocate the receiving antenna.
- Increase the separation between the equipment and receiver.
- Connect the equipment into an outlet on a circuit different from that to which the receiver is connected.
- Consult the dealer or an experienced radio/TV technician for help.

WARNING: TO PREVENT FIRE OR SHOCK HAZARD, DO NOT EXPOSE THIS UNIT TO RAIN OR MOISTURE.

SURGE PROTECTORS:
It is recommended to use a surge protector for AC connection. Lightning and power surges ARE NOT covered under warranty for this product.

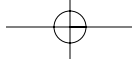

Dear Customer

Selecting fine audio equipment such as the unit you've just purchased is only the start of your musical enjoyment. Now it's time to consider how you can maximize the fun and excitement your equipment offers. This manufacturer and the Electronic Industries Association's Consumer Electronics Group want you to get the most out of your equipment by playing it at a safe level. One that lets the sound come through loud and clear without annoying blaring or distortion and, most importantly, without affecting your sensitive hearing. Sound can be deceiving. Over time your hearing "comfort level" adapts to higher volumes of sound. So what sounds "normal" can actually be loud and harmful to your hearing. Guard against this by setting your equipment at a safe level BEFORE your hearing adapts.

To establish a safe level:

- Start your volume control at a low setting.
- Slowly increase the sound until you can hear it comfortably and clearly, and without distortion.

Once you have established a comfortable sound level:

- Set the dial and leave it there.

Taking a minute to do this now will help to prevent hearing damage or loss in the future. After all, we want you listening for a lifetime.

We Want You Listening For A Lifetime

Used wisely, your new sound equipment will provide a lifetime of fun and enjoyment. Since hearing damage from loud noise is often undetectable until it is too late, this manufacturer and the Electronic Industries Association's Consumer Electronics Group recommend you avoid prolonged exposure to excessive noise. This list of sound levels is included for your protection.

Decibel

<u>Level</u>	<u>Example</u>
30	Quiet library, soft whispers
40	Living room, refrigerator, bedroom away from traffic
50	Light traffic, normal conversation, quiet office
60	Air conditioner at 20 feet, sewing machine
70	Vacuum cleaner, hair dryer, noisy restaurant
80	Average city traffic, garbage disposals, alarm clock at two feet

THE FOLLOWING NOISES CAN BE DANGEROUS UNDER CONSTANT EXPOSURE:

90	Subway, motorcycle, truck traffic, lawn mower
100	Garbage truck, chain saw, pneumatic drill
120	Rock band concert in front of speakers, thunderclap
140	Gunshot blast, jet engine
180	Rocket launching pad

Information courtesy of the Deafness Research Foundation.

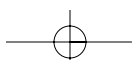

SAFETY INSTRUCTIONS

Before using the unit, be sure to read all operating instructions carefully. Please note that these are general precautions and may not pertain to your unit. For example, this unit may not have the capability to be connected to an outdoor antenna.

1. READ INSTRUCTIONS

All the safety and operating instructions should be read before the product is operated.

2. RETAIN INSTRUCTIONS

The safety and operating instructions should be retained for future reference.

3. HEED WARNINGS

All warnings on the product and in the operating instructions should be adhered to.

4. FOLLOW INSTRUCTIONS

All operating and use instructions should be followed.

5. CLEANING

Unplug this product from the wall outlet before cleaning. Do not use liquid cleaners or aerosol cleaners. Use a damp cloth for cleaning.

6. ATTACHMENTS

Do not use attachments not recommended by the product's manufacturer as they may cause hazards.

7. WATER AND MOISTURE

Do not use this product near water- for example, near a bathtub, washbowl, kitchen sink, or laundry tub, in a wet basement, or near a swimming pool.

8. ACCESSORIES

Do not place this product on an unstable cart, stand, tripod, bracket, or table. The product may fall, causing serious injury and serious damage to the product. Use only with a cart, stand, tripod, bracket, or table recommended by the manufacturer or sold with the product. Any mounting of the product should follow the manufacturer's instructions, and should use a mounting accessory recommended by the manufacturer.

PORTABLE CART WARNING
(symbol provided by RETAC)



- 8A. An appliance and cart combination should be moved with care. Quick stops, excessive force, and uneven surfaces may cause the appliance and cart combination to overturn.

9. VENTILATION

Slots and openings in the cabinet and in the back or bottom are provided for ventilation and to ensure reliable operation of the product and to protect it from overheating. These openings must not be blocked or covered. The openings should never be blocked by placing the product on a bed, sofa, rug, or other similar surface. This product should never be placed near or over a radiator or heat source. This product should not be placed in a built-in installation such as a bookcase or rack unless proper ventilation is provided or the manufacturer's instructions have been adhered to.

10. POWER SOURCES

This product should be operated only from the type of power source indicated on the marking label. If you are not sure of the type of power supply to your home, consult your appliance dealer or local power company. For products intended to operate from battery power, or other sources, refer to the operating instructions.

11. GROUNDING OR POLARIZATION

This product is equipped with a polarized alternating-current line plug (a plug having one blade wider than the other). This plug will fit into the power outlet only one way. This is a safety feature. If you are unable to insert the plug fully into the outlet, try reversing the plug. If the plug should still fail to fit, contact your electrician to replace your obsolete outlet. Do not defeat the safety purpose of the polarized plug.

12. POWER-CORD PROTECTION

Power-supply cords should be routed so that they are not likely to be walked on or pinched by items placed upon or against them, paying particular attention to cords at plugs, convenience receptacles, and the point where they exit from the appliance.

13. LIGHTNING

To protect your product from a lightning storm, or when it is left unattended and unused for long periods of time, unplug it from the wall outlet and disconnect the antenna or cable system. This will prevent damage to the product due to lightning and power-line surges.

14. POWER LINES

An outside antenna system should not be located in the vicinity of overhead power lines or other electric light or power circuits, or where it can fall into such power lines or circuits. When installing an outside antenna system, extreme care should be taken to keep from touching such power lines or circuits as contact with them might be fatal.

15. OVERLOADING

Do not overload wall outlets and extension cords as this can result in a risk of fire or electric shock.

16. OBJECT AND LIQUID ENTRY

Never push objects of any kind into this product through openings as they may touch dangerous voltage points or short out parts that could result in fire or electric shock. Never spill or spray any type of liquid on the product.

17. OUTDOOR ANTENNA GROUNDING

If an outside antenna is connected to the product, be sure the antenna system is grounded so as to provide some protection against voltage surges and built-up static charges. Section 810 of the National Electric Code, ANSI/NFPA 70, provides information with respect to proper grounding of the mast and supporting structure, grounding of the lead-in wire to an antenna discharge product, size of grounding conductors, location of antenna discharge product, connection to grounding electrodes, and requirements for grounding electrode.

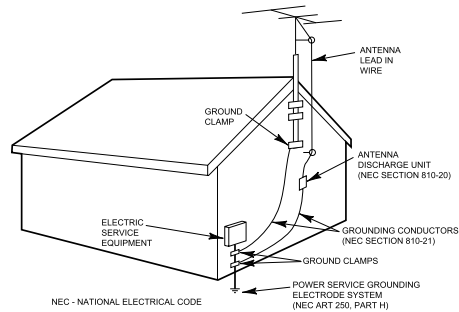

S2898A
EXAMPLE OF ANTENNA GROUNDING AS PER
NATIONAL ELECTRICAL CODE

18. SERVICING

Do not attempt to service this product yourself as opening or removing covers may expose you to dangerous voltage or other hazards. Refer all servicing to qualified service personnel.

19. REPLACEMENT PARTS

When replacement parts are required, be sure the service technician uses replacement parts specified by the manufacturer or those that have the same characteristics as the original part. Unauthorized substitutions may result in fire, electric shock or other hazards.

20. SAFETY CHECK

Upon completion of any service or repairs to this product, ask the service technician to perform safety checks to determine that the product is in proper operating condition.

21. WALL OR CEILING MOUNTING

The product should be mounted to a wall or ceiling only as recommended by the manufacturer.

22. DAMAGE REQUIRING SERVICE

Unplug the product from the wall outlet and refer servicing to qualified service personnel under the following conditions:

- When the power-supply cord or plug is damaged.
- If liquid has been spilled, or objects have fallen into the product.
- If the product has been exposed to rain or water.
- If the product does not operate normally by following the operating instructions. Adjust only those controls that are covered by the operating instructions, as an adjustment of other controls may result in damage and will often require extensive work by a qualified technician to restore the product to its normal operation.
- If the product has been dropped or the cabinet has been damaged.
- When the product exhibits a distinct change in performance - this indicates a need for service.

23. HEAT

The product should be situated away from heat sources such as radiators, heat registers, stoves, or other products (including amplifiers) that produce heat.

24. NOTE TO CATV SYSTEM INSTALLER

This reminder is provided to call the CATV system installer's attention to Article 820-40 of the NEC that provides guidelines for proper grounding and, in particular, specifies that the cable ground shall be connected to the grounding system of the building, as close to the point of cable entry as practical.

LOCATION OF CONTROLS

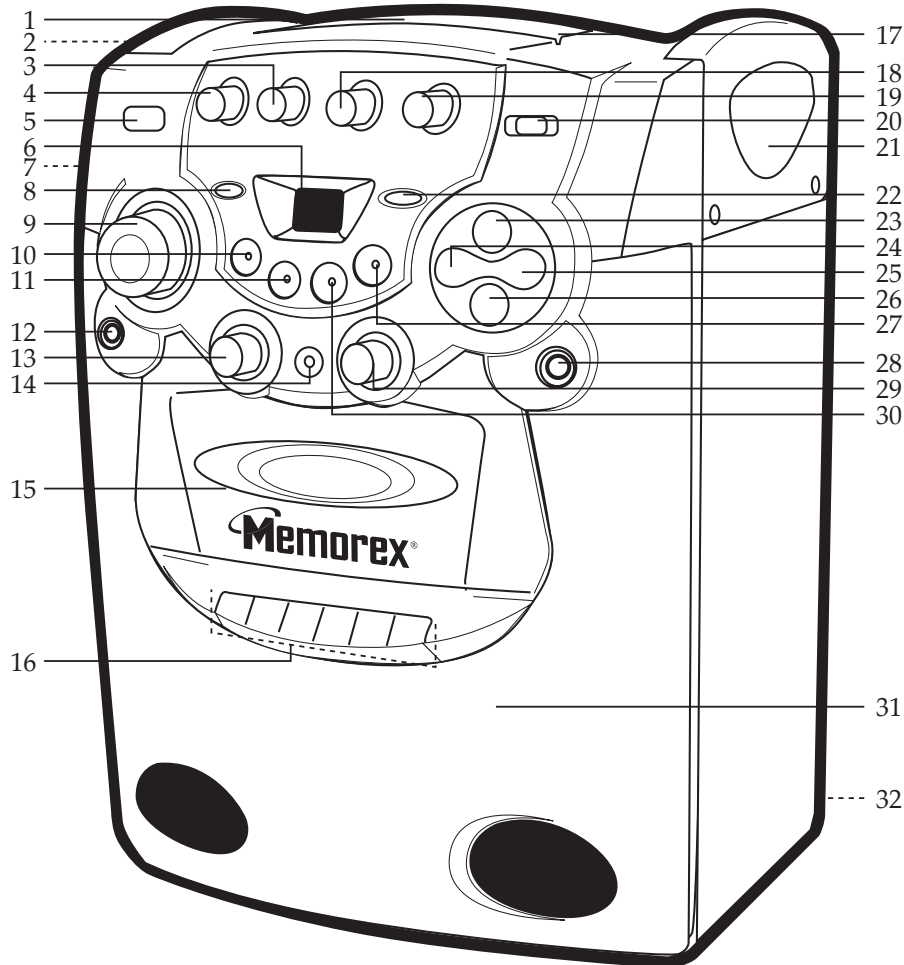

- | | |
|---|--------------------------------|
| 1. CD Compartment | REWIND (◀◀) |
| 2. Carrying Handle | PLAY (▶) |
| 3. TONE Control | RECORD (●) |
| 4. BALANCE Control | 17. CD Door OPEN/CLOSE Area |
| 5. POWER Button | 18. ECHO Control |
| 6. CD Display | 19. VOCAL Control |
| 7. AUDIO/VIDEO OUT Jacks (Rear of Unit) | 20. FUNCTION (TAPE/CDG) Switch |
| 8. PROGRAM Button | 21. Carrying Handle |
| 9. MASTER VOLUME Control | 22. REPEAT Button |
| 10. PROGRAM Indicator | 23. Play/Pause (▶) Button |
| 11. REPEAT Indicator | 24. Skip/Search (◀◀) Button |
| 12. MIC 1 Jack | 25. Skip/Search (▶▶) Button |
| 13. MIC 1 VOLUME Control | 26. Stop (■) Button |
| 14. PHONES (Headphones) Jack | 27. PLAY/PAUSE Indicator |
| 15. Cassette Compartment | 28. MIC 2 Jack |
| 16. Cassette Buttons (right to left): | 29. MIC 2 VOLUME Control |
| PAUSE () | 30. POWER Indicator |
| STOP/EJECT (■▲) | 31. Speaker |
| FAST FORWARD (▶▶) | 32. AC Cord (Rear of Unit) |

POWER SOURCE

AC:

Use the AC polarized line cord included with the unit for operation on AC power. Insert into a conveniently located AC outlet having 120V, 60Hz.

NOTE: The AC plug supplied with the unit is polarized to help minimize the possibility of electric shock. If the AC plug does not fit into a nonpolarized AC outlet, do not file or cut the wide blade. It is the user's responsibility to have an electrician replace the obsolete outlet.

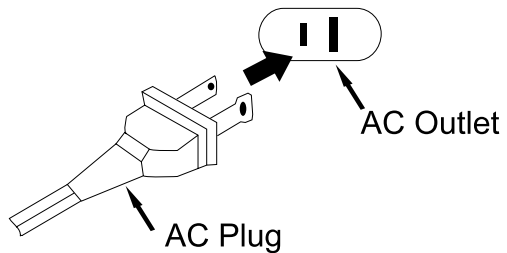

OPTIONAL CONNECTIONS

If you are using special CD+G (Graphics) discs in this portable Karaoke system, you must connect this unit to a television set in order to see the On Screen Graphics that are recorded on CD+G Karaoke discs.

The video cable has yellow RCA type plugs on each end. Please note that your TV set must have an RCA type Video Input Jack in order to view the CD+G lyrics on your TV screen. You cannot connect this portable Karaoke system to your TV's coaxial antenna terminal.

Also note that On Screen lyrics are only available on special Karaoke compact discs that bear the CD+G mark.



Many newer TV sets have a set of Video and Stereo Audio jacks on the front panel for quick and easy connections without having to turn the TV set to gain access to the jacks on the back panel. If your TV set has such front panel A/V jacks, we suggest that you use those jacks to connect your portable Karaoke.

After connecting the Video Out jack on this portable Karaoke to the Video In jack on your TV with the included video cable, you have the following three choices:

1. Listen to the sound from the built-in speakers in this portable Karaoke system. In this case, no external audio connections are required.
2. If your TV has stereo audio input jacks, you can connect the Audio Out jacks on the back of this unit to the Audio In jacks on your TV. The stereo audio connection cable is included. In this case, the lyrics from the CD+G disc will appear on your TV screen and the sound from the disc will be heard from your TV speakers.

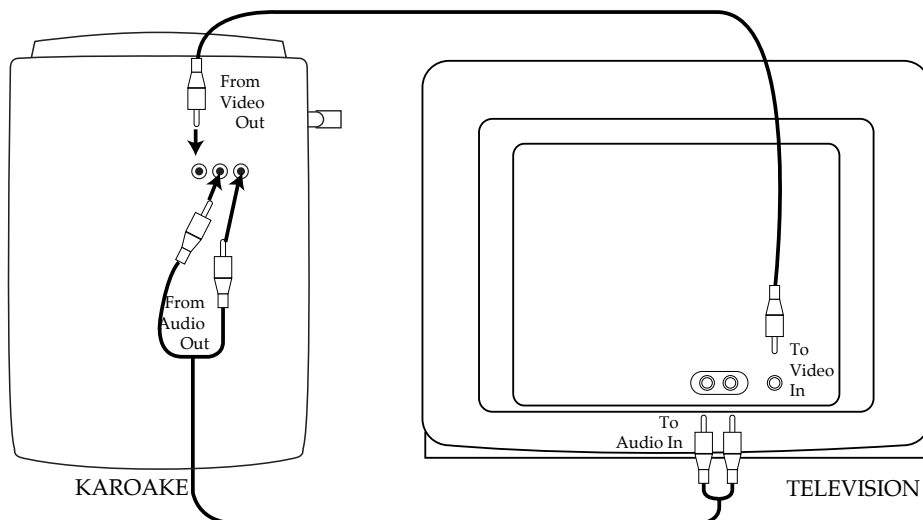

OPTIONAL CONNECTIONS (CONTINUED)

Note: If you have a mono TV with only one Audio In jack, you may have to purchase a “Y” adapter (stereo to mono) at your local electronics accessories store in order to combine the Left and Right stereo channels from this portable Karaoke to a single mono channel for connection to your mono TV.

3. You can connect the Audio Out jacks from this portable Karaoke to the Aux In or Audio In jacks of your home stereo system to hear the sound through your home stereo speakers. Follow the instructions for your home stereo system to select the device connected to the external jacks as the audio source.

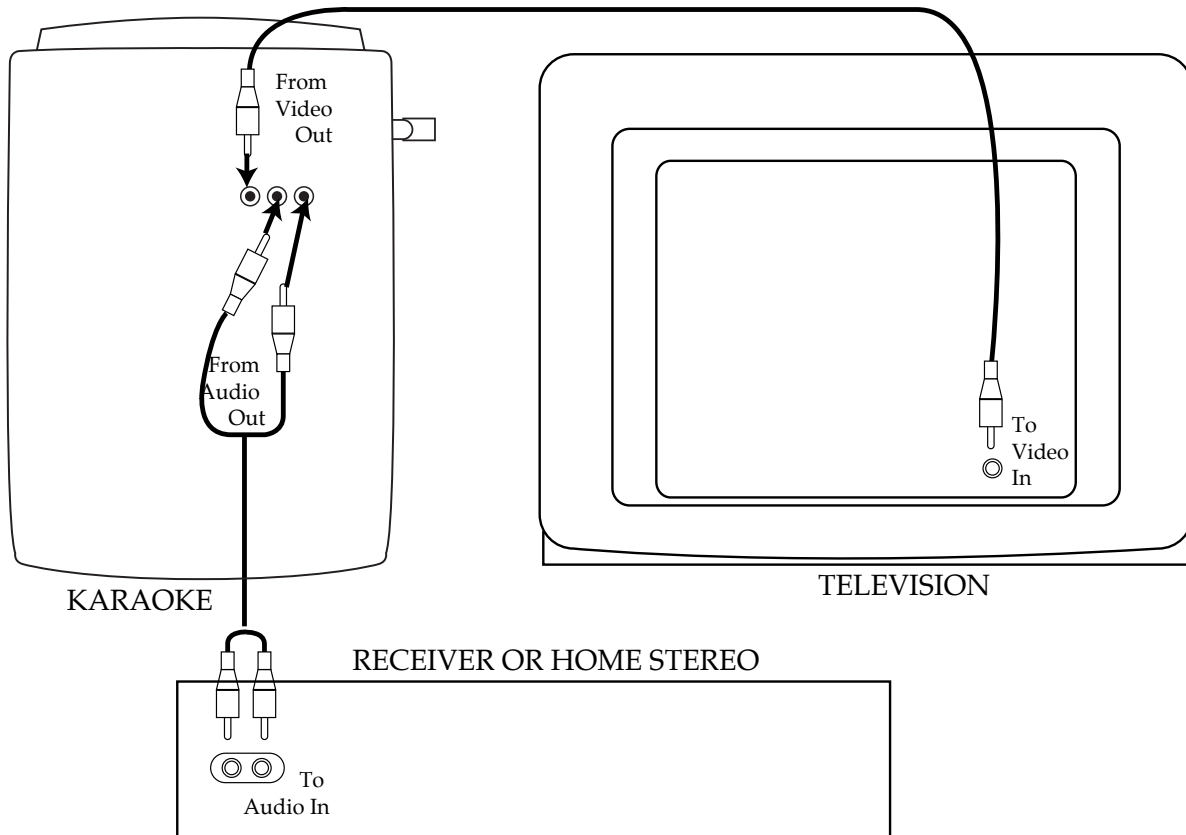

OPERATION

ECHO CONTROL

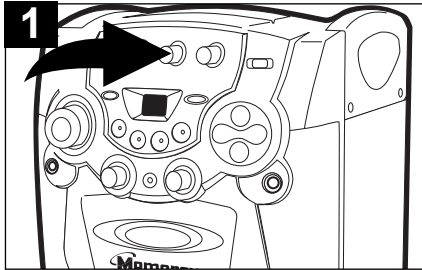

Rotate the ECHO control clockwise to increase the echo or counterclockwise to decrease the echo.

AUTO VOCAL CONTROL

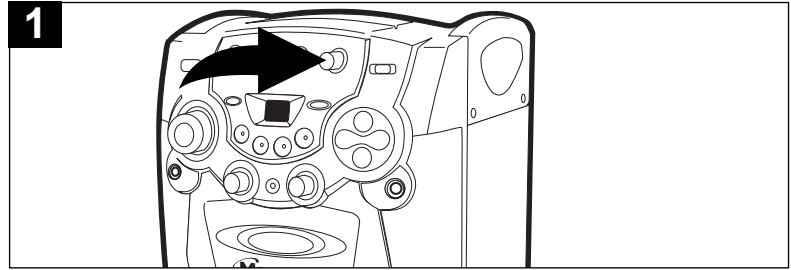

When the VOCAL feature is activated, the vocals on a multiplex recording are muted as soon as the singer begins singing into the microphone. When the singer stops singing, the vocals are automatically unmuted. Adjust the AUTO VOCAL control for the best balance between playback and microphone levels.

IMPORTANT: This feature only works with multiplex CDs.

MIC ON/OFF SWITCH

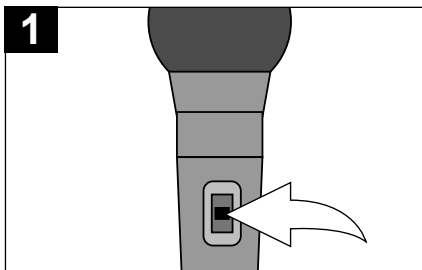

To turn the microphone on, slide the ON/OFF switch, located on the side of the microphone, to the ON position. To turn the microphone off, slide the ON/OFF switch to the OFF position.

BALANCE CONTROL (KARAOKE)

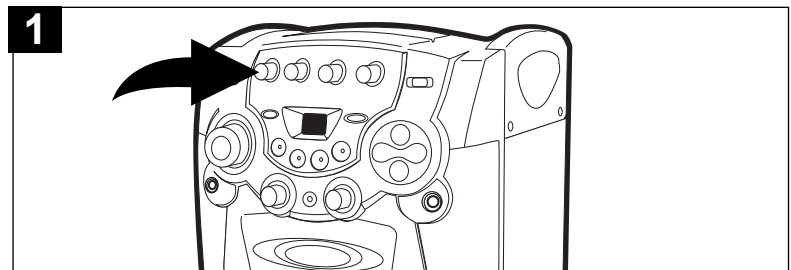

Rotate the BALANCE control clockwise to decrease the music sound level or counterclockwise to decrease the vocal sound level.

NOTE: To use the BALANCE control, a karaoke tape or CD+G disc must be used.

TONE CONTROL

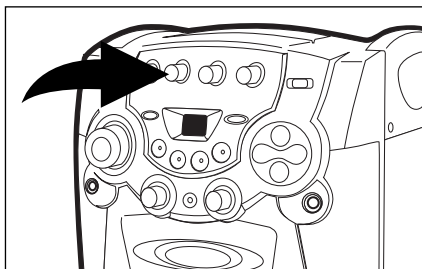

Rotate the TONE control clockwise to increase the tone response or counterclockwise to decrease the tone response.

CONNECTING THE MICROPHONE(S)

This unit has two microphone jacks, use one with the supplied microphones, which will allow you to sing along with your favorite songs. Before connecting, make sure the MIC VOLUME Controls are set to minimum.

If only connecting one microphone, connect it to the MIC1 jack.

HEADPHONE JACK

For private listening, connect low impedance 3.5mm (32 ohm) stereo headphones (not included) to this jack. The speaker is disconnected when using the headphones.

OPERATION (CONTINUED)

PLAYING COMPACT DISCS

NORMAL PLAYBACK

(For karaoke playback, please refer to page 12)

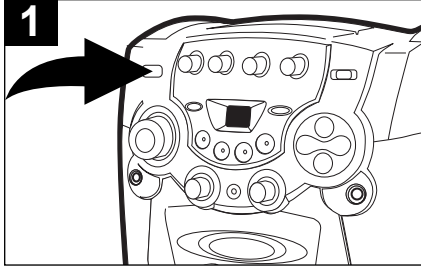

1 Press the POWER button to turn the unit on; the POWER indicator will light.

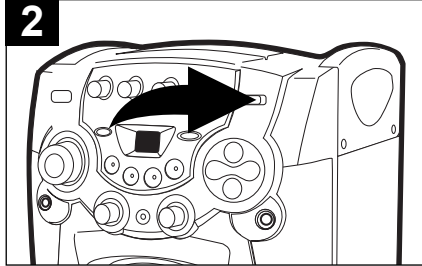

2 Slide the FUNCTION switch to the CDG position.

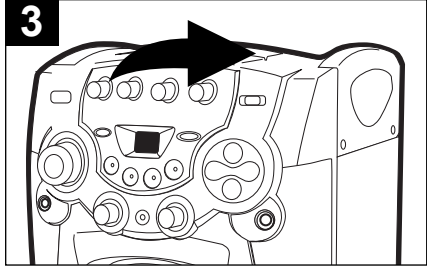

3 Press the CD Door OPEN/CLOSE area to open the CD compartment door. Place a CD on the center spindle, with the printed label side facing up. Close the CD compartment door.

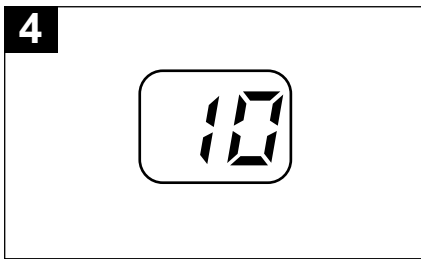

4 The CD player will read the table of contents on the disc and the total number of tracks will appear in the display.

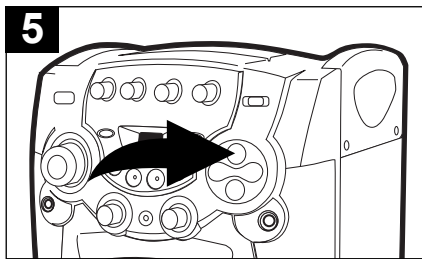

5 Press the Play/Pause (▶||) button to begin playback on Track 1; the PLAY/PAUSE indicator will light.

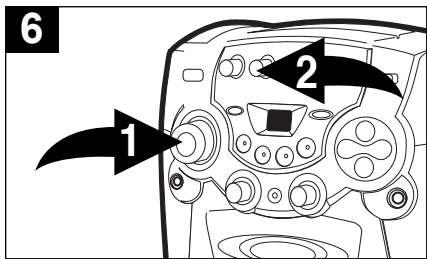

6 Adjust the MASTER VOLUME ❶ and TONE ❷ controls as desired.

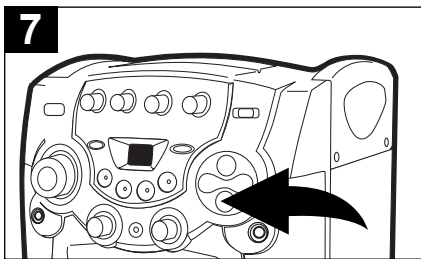

7 To stop playback before the disc ends, press the Stop (■) button. The disc will stop and the display will show the total number of tracks on the disc.

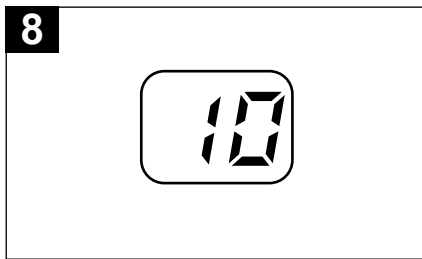

8 After the last track has been played, the disc stops automatically and the display shows the total number of tracks on the disc.

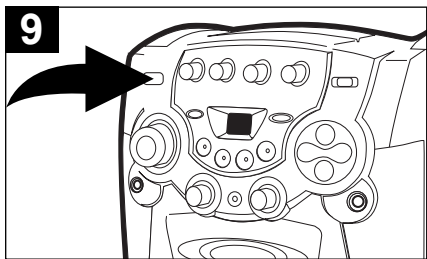

9 Remove your disc, close the CD Compartment door and press the POWER button to turn the unit off; the POWER indicator will turn off.

OPERATION (CONTINUED)

CD PAUSE CONTROL

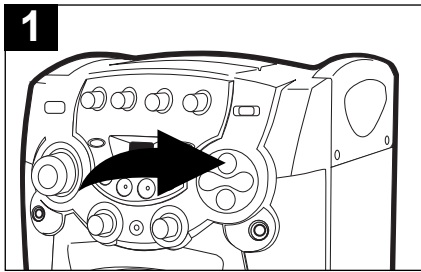

1
During CD playback, if you wish to pause the disc momentarily, press the Play/Pause (▶||) button. Playback stops but the disc continues to spin and the PLAY/PAUSE indicator will blink.

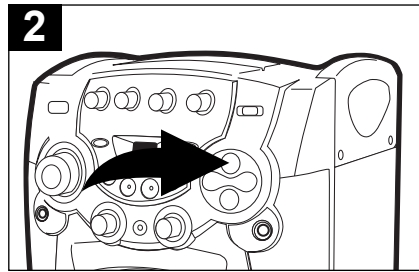

2
Press the Play/Pause (▶||) button again to release pause and resume normal CD playback; the PLAY/PAUSE indicator will remain on.

TO BEGIN PLAYBACK FROM A SPECIFIC TRACK

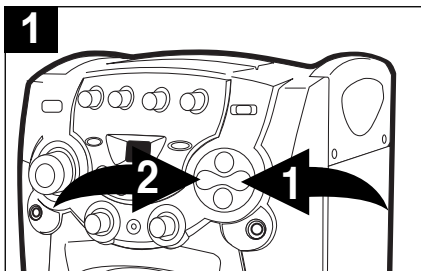

1
After you insert the disc into the CD player and the total number of tracks appear in the display, you may press either the Skip/Search (▶▶) ❶ or (◀◀) ❷ button to select a specific track for playback.

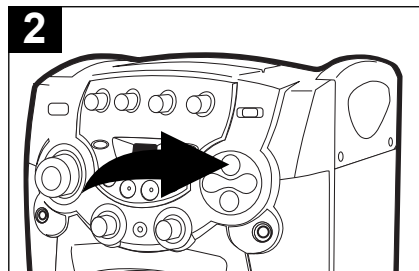

2
When the desired track number blinks in the display, within five seconds, press the Play/Pause (▶||) button. Playback will begin on the track you selected.

FORWARD/REVERSE SKIP TRACK AND HIGH-SPEED MUSIC SEARCH (◀◀/▶▶)

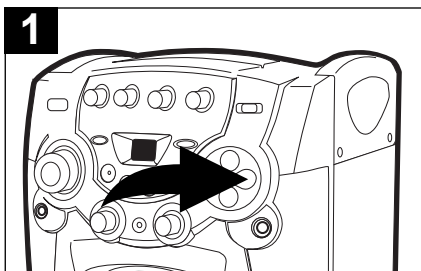

1
During playback, press the Skip/Search (▶▶) button once to advance the player to the beginning of the next track. Press the Skip/Search (▶▶) button repeatedly to advance the player to higher numbered tracks.

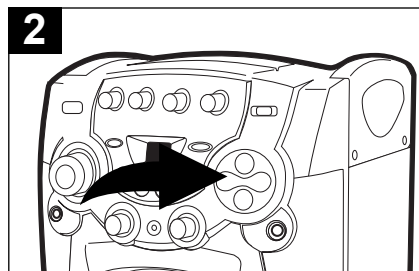

2
During playback, press the Skip/Search (◀◀) button once to move the player back to the beginning of the current track. Press the Skip/Search (◀◀) button repeatedly to move the player back to lower numbered tracks.

3
CD ONLY
During playback, depress and hold either the Skip/Search (▶▶) or (◀◀) button to move the player forward or backward within a track to locate a specific musical passage. The player will move forward or backward at high speed as long as the button is depressed. When you release the Skip/Search (▶▶) or (◀◀) button, normal playback will resume.

OPERATION (CONTINUED)

REPEAT PLAYBACK

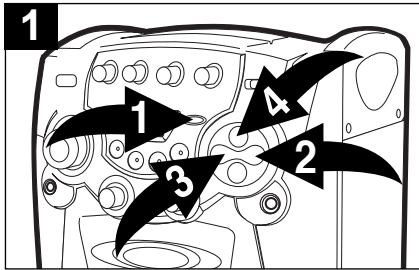

To repeat a single track, press the REPEAT button ❶ once; the REPEAT indicator will blink. Press the Skip/Search (▶▶) ❷ or (◀◀) button ❸ to select the specific track that you wish to repeat. When the desired track number blinks in the display, within five seconds, press the PLAY/PAUSE (▶||) button ❹ to begin playback. The specific track you selected will be repeated continuously.

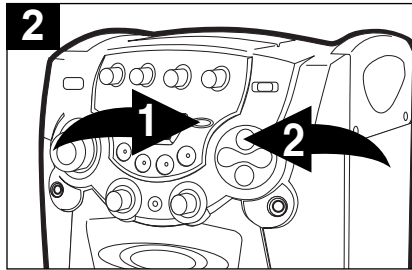

To repeat all of the tracks on a disc continuously, press the REPEAT button ❶ twice; the REPEAT indicator will light solid. Press the Play/Pause (▶||) button ❷ to repeat all tracks.

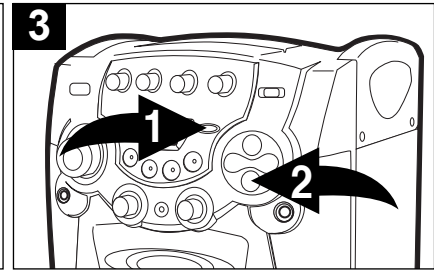

To cancel Repeat Playback, press the REPEAT button ❶ until the REPEAT indicator goes out. You can also cancel Repeat Playback by pressing the Stop (■) button ❷.

PROGRAMMED PLAYBACK

The CD player in this unit has a 19 track programmable memory that allows you to program up to 19 tracks on any disc for playback in any desired order. You may program 19 different tracks or you may also program certain tracks to play more than once.

To perform programmed playback, proceed as follows:

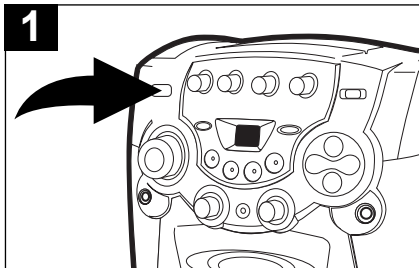

Press the POWER button to turn the unit on; the POWER indicator will light.

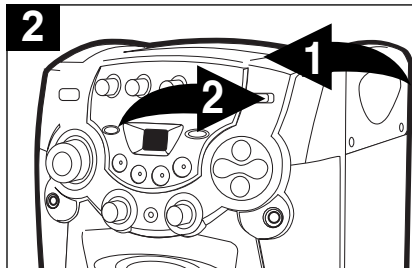

Press the CD Door OPEN/CLOSE area ❶ to open the CD compartment door. Place a CD on the center spindle, with the printed label side facing up. Slide the FUNCTION control ❷ to the CDG position. Close the CD compartment door.

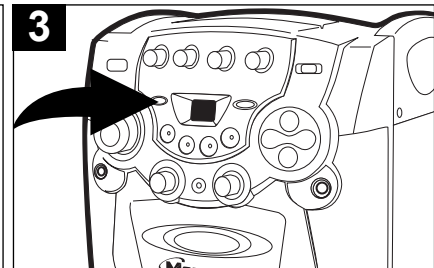

Press the PROGRAM button; the PROGRAM indicator and display will blink.

PROGRAMMED PLAYBACK CONTINUED ON THE NEXT PAGE

OPERATION (CONTINUED)

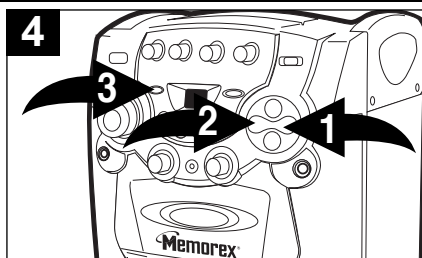

4 Press the Skip/Search (▶▶) **1** or (◀◀) button **2** to select the first track that you wish to program. When the desired track number appears in the display, press the PROGRAM button **3** again.

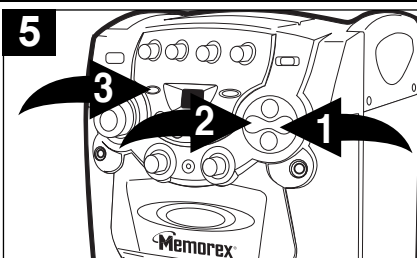

5 Press either the Skip/Search (▶▶) **1** or (◀◀) button **2** to select the next track you wish to program. When the desired track number appears in the display, press the PROGRAM button **3** again.

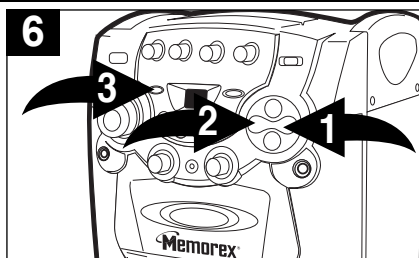

6 Repeat step 5 until you have programmed up to 19 track numbers into the CD Program Memory. When the memory is full, “- -” will appear in the display.

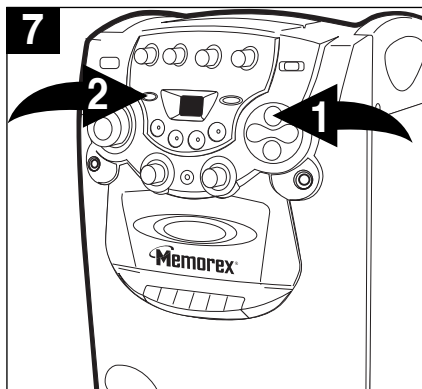

7 After programming up to 19 tracks in the CD Program Memory, press the Play/Pause (▶||) button **1** to begin programmed playback. The PROGRAM indicator will blink and playback will begin on the first track that you programmed. The player will continue to play all of the tracks that you programmed in the order in which you programmed them. When the last programmed track has been played, the player will stop and the display will again show the total number of tracks on the disc. If you press the PROGRAM button **3** and then press the Play/Pause (▶||) button **1** again, playback will start on the first track you programmed and will continue until all the programmed tracks have been played.

To cancel programmed playback, while in the Stop mode, press the PROGRAM button followed by the Stop (■) button or open the CD Door.

To check the programmed tracks, while in the Stop mode, press the PROGRAM button repeatedly to view the programmed tracks.

PROGRAMMED REPEAT

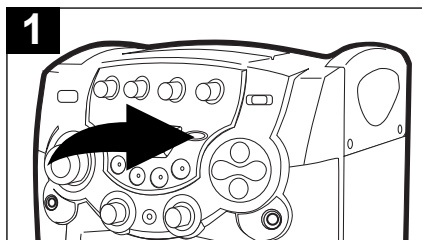

1 It is also possible to use the Program and Repeat functions together to repeat a specific program indefinitely. First, program the tracks you wish to hear in the order you wish to hear them, as described above. Then, press the REPEAT button twice. The PROGRAM indicator will blink and the REPEAT indicator will light.

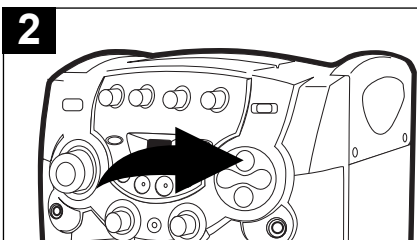

2 Press the Play/Pause (▶||) button to begin programmed repeat playback. The player will play the tracks you selected in the order in which you programmed them. When the last track in the program has been played, the entire program will begin again.

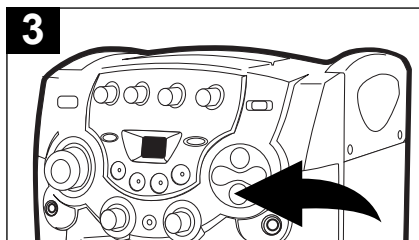

3 Programmed Repeat operation will continue indefinitely until you press the Stop (■) button or open the CD door.

OPERATION (CONTINUED)

PLAYING A CD+G (COMPACT DISC + GRAPHICS) DISC KARAOKE

You can listen to a CD+G karaoke disc. CD+G discs combine the recorded music with an additional video track that displays the song lyrics on a television screen. As the song plays, the words to be sung are highlighted in a different color on most CD+Gs.

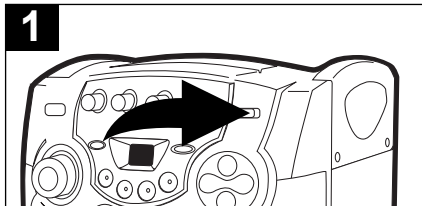

1 Insert a CD+G disc. Insert the microphone into the MIC jack(s) and slide the FUNCTION switch to the CDG position. Make sure the unit is connected to a TV or TV and stereo as shown on pages 5 and 6.

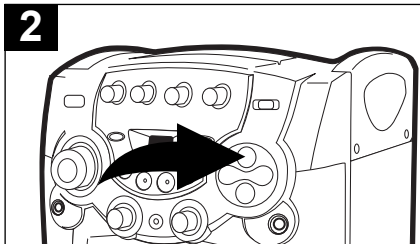

2 Press the Play/Pause (▶||) button to start CD/CD+G playback. If connected to a TV and using a CD+G disc, the image and lyrics will appear on the TV.

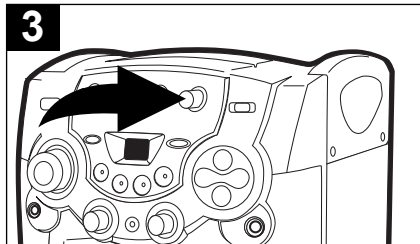

3 Adjust the AUTO VOCAL control as described below.

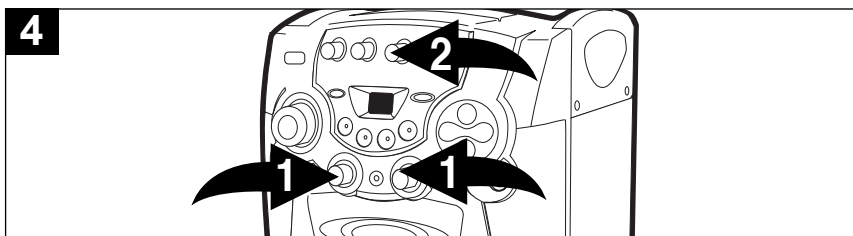

4 Adjust the MIC VOLUME control(s) ❶ as desired. Increasing this control will increase the volume of the microphone. Adjust the ECHO control ❷ to add an echo effect to your voice. The ECHO control ❷ is variable so add as much or as little reverb as desired. Sing or talk into the microphone and you will hear both the CD+G and the microphone.

When the VOCAL feature is activated, the vocals on a multiplex recording are muted as soon as the singer begins singing into the microphone. When the singer stops singing, the vocals are automatically unmuted. Adjust the AUTO VOCAL control for the best balance between playback and microphone levels.

IMPORTANT: This feature only works with multiplex CDs.

NOTE: The Program and Repeat features on a CD+G CD operate the same as with standard CD.

INFORMATION ABOUT CD+G KARAOKE DISCS:

CD+G Karaoke discs are designed specifically for playback in special CD players that include a CD+G decoder, such as this unit. These discs contain the lyrics to each song and the lyrics will appear on your TV screen, line by line, as the disc is playing. Usually the words on the screen will change color in time with the music to help you sing along at the proper tempo, even if you do not know the song.

Most CD+G Karaoke discs have all of the songs recorded twice, first with music only, and then with music and vocal together. For example, if you purchase a CD+G disc containing four songs, tracks one through four will have the music only without vocals, and tracks five through eight will have the same four songs recorded with music on the left channel and the vocal tracks on the right channel.

If you wish to sing along "solo" without any other vocals, you should select tracks one through four (for example). If you wish to sing a "duet" or be part of a group, select tracks five through eight (for example) that contain both the music and vocals.

NOTE: Make sure the BALANCE control is set to the center position so you can hear both the vocal and music tracks at an equal level.

MICROPHONE FEEDBACK:

"Feedback" is a howling or screeching sound that occurs when the microphone comes too close to the speaker(s). To avoid microphone feedback, keep the microphone as far away from the speakers as the microphone cable will allow. If you must bring the microphone close to the speakers, such as when you are changing a disc or adjusting one of the other controls on the front of the unit, set the microphone ON/OFF switch to the OFF position.

OPERATION (CONTINUED)

PLAYING CASSETTE TAPES OR KARAOKE

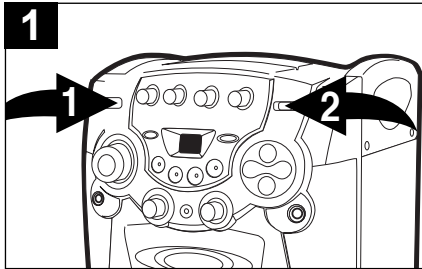

Press the POWER button ❶ to turn the unit on; the POWER indicator will light. Slide the FUNCTION switch ❷ to the TAPE position.

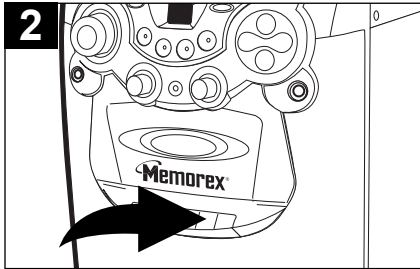

Press the STOP/EJECT (■▲) button to open the Cassette Door and insert a cassette with the open end facing down.

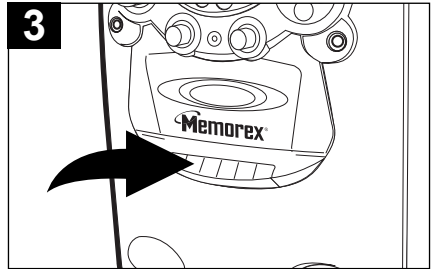

Press the PLAY (▶) button to begin playback.

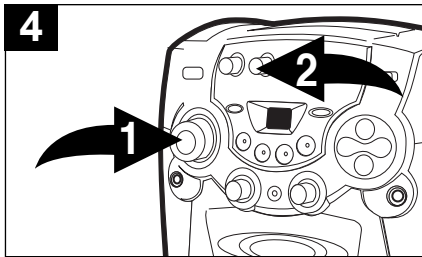

Adjust the MASTER VOLUME ❶ and TONE ❷ controls as desired.

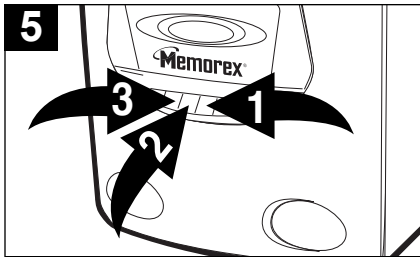

To advance or rewind the tape rapidly, press either the F.FWD (▶▶) ❶ or REWIND (◀◀) ❷ button. When you reach the desired point, press the PLAY (▶) button ❸ to resume normal playback.

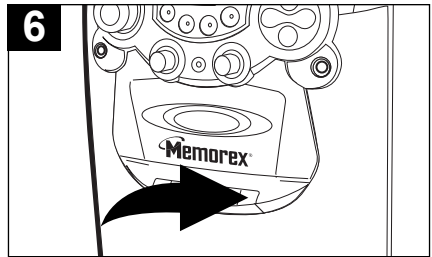

To pause playback momentarily, press the PAUSE (||) button. The tape movement stops but the tape motor is still running. Press the PAUSE (||) button again to release pause and resume normal playback.

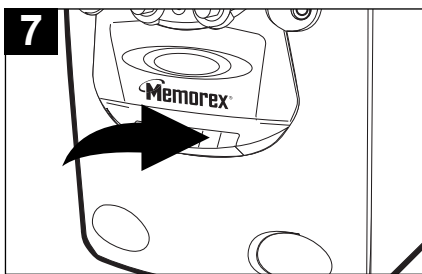

To stop playback before the tape ends, press the STOP/EJECT (■▲) button. The PLAY (▶) button is released and the tape motor shuts off.

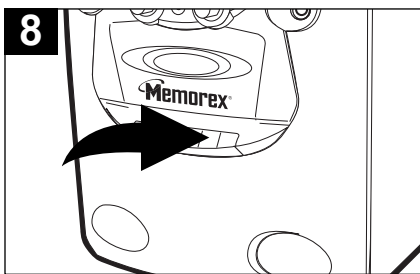

When the tape reaches the end, the auto-stop mechanism activates, the PLAY (▶) button is released and the tape motor shuts off. Press the STOP/EJECT (■▲) button to open the Cassette Door and remove the tape.

KARAOKE:

If you would like to sing along with a tape, simply play the tape, insert a microphone and sing along!

OPERATION (CONTINUED)

KARAOKE RECORDING FROM A CD OR CD+G (COMPACT DISC + GRAPHICS) DISC

You can record onto a cassette tape from a CD+G karaoke disc or standard CD. CD+G discs combine the recorded music with an additional video track that displays the song lyrics on a television screen. As the song plays, the words to be sung are highlighted in a different color.

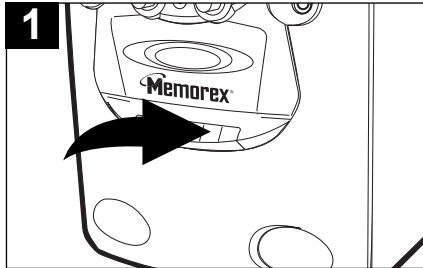

1 Press the STOP/EJECT (■▲) button to open the Cassette Door and insert a cassette with the open end facing down.

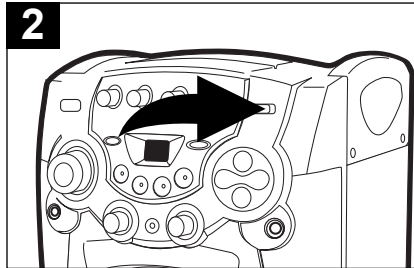

2 Slide the FUNCTION switch to the CDG position. Insert the microphone into the appropriate jack.

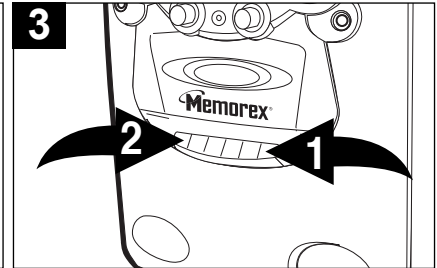

3 Press the PAUSE (||) button ❶, then press the RECORD (●) button ❷ (the PLAY button will be automatically depressed).

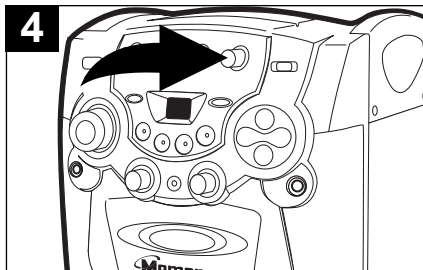

4 Adjust the AUTO VOCAL control for the best balance between playback and microphone levels. **IMPORTANT:** This feature only works with multiplex CDs.

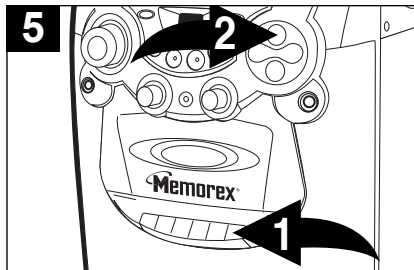

5 Press the PAUSE button ❶ to release pause and then press the CD Play/Pause (▶/||) button ❷ to start CD/CD+G playback. If connected to a TV and using a CD+G disc, the image and lyrics will appear on the TV.

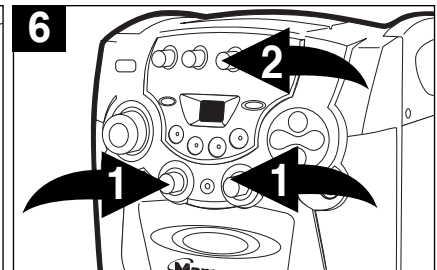

6 Adjust the MIC1/MIC2 VOLUME controls ❶ as desired. Increasing this control will increase the volume of the respective microphone. Adjust the ECHO control ❷ to add an echo effect to your voice. The ECHO control ❷ is variable so add as much or as little reverb as desired.

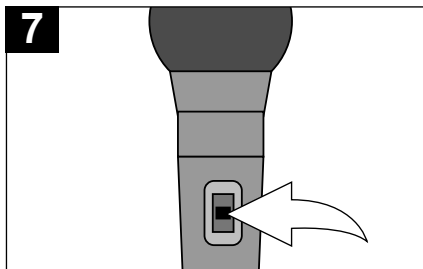

7 Turn the microphone on using the Microphone ON/OFF switch. Sing or talk into the microphone(s) and both the CD/CD+G and the microphone(s) will be recorded onto the cassette.

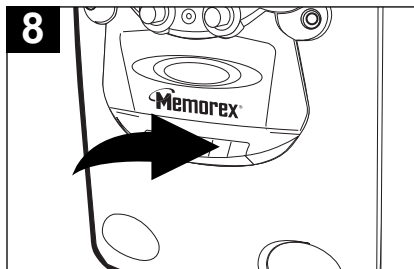

8 When you are finished recording, press the STOP/EJECT (■▲) button to stop the tape.

NOTES:

- Refer to SAFEGUARD AGAINST ACCIDENTAL ERASURE section (page 15) if the RECORD button cannot be pressed.
- Keep the microphone away from the unit to avoid feedback.

CARE AND MAINTENANCE

SAFEGUARD AGAINST ACCIDENTAL ERASURE

When a new recording is made, any program material previously recorded is automatically erased and only the new recording remains. To safeguard valuable recordings from being erased accidentally, the cassette and the deck are equipped with a special device.

On the back of the cassette there is an erase prevention tab on each side. To prevent accidental erasing, break out these tabs with a screwdriver. If only one side of the tape is to be protected, break out the tab on the left side with the side desired facing you.

To record on a tape in which the tab has been broken, place a piece of adhesive tape over that area.

NOTE: When a tab is broken out, the record button cannot be depressed.

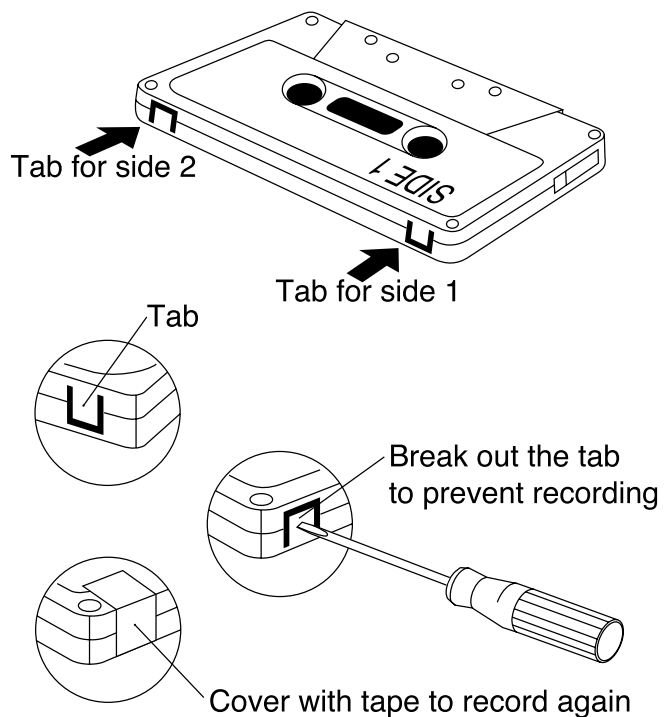

CASSETTE TAPE RECOMMENDATIONS

Standard tape lengths have 15 (C-30), 30 (C-60) and 45 (C-90) minutes of recording time on each side. Longer length tapes of 60 (C-120) minutes of recording time on each side are not recommended. Use only high quality tapes. If a problem develops, check the unit first with another cassette to determine if the problem is with the cassette, and not with the unit.

If there is any slack in the cassette, it should be removed before inserting the cassette. Place a pencil in one of the hubs and rotate it clockwise until all slack is taken up.

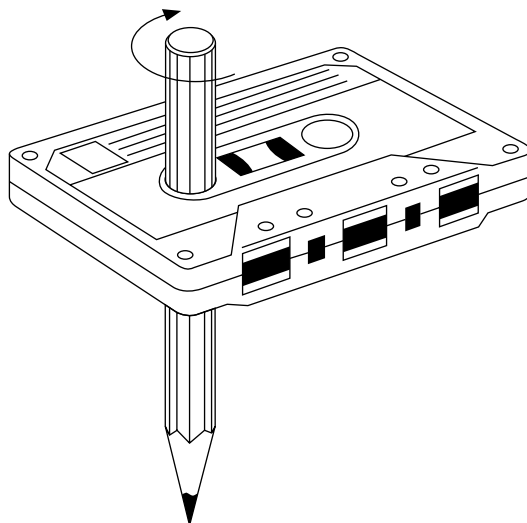

CARE AND MAINTENANCE (CONTINUED)

Caring for Compact Discs

- Treat the compact disc carefully. Handle the compact disc only by its edges. Never allow your fingers to come in contact with the shiny, unprinted side of the compact disc.
- Do not attach adhesive tape, stickers, etc. to the compact disc label.
- Clean the compact disc periodically with a soft, lint-free, dry cloth. Never use detergents or abrasive cleaners to clean the compact disc. If necessary, use a CD cleaning kit.
- If a disc skips or gets stuck on a section of the compact disc, it is probably dirty or damaged (scratched).
- When cleaning the compact disc, wipe in straight lines from the center of the compact disc to the outer edge of the compact disc. Never wipe in circular motions.

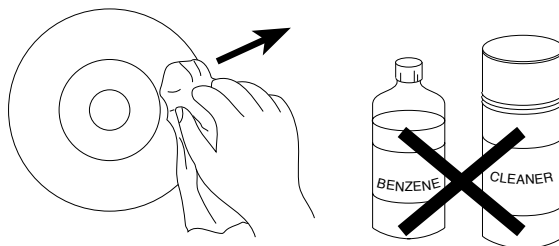
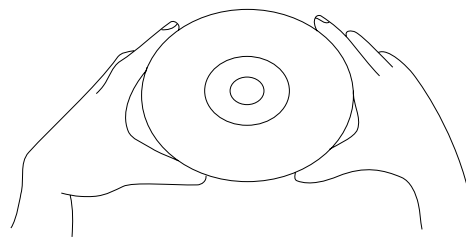

- This unit is designed to play only compact discs bearing the identification logo as shown here. Other discs may not conform to the CD standard and may not play properly.
- Compact Discs should be stored in their cases after each use to avoid damage.
- Do not expose compact discs to direct sunlight, high humidity, high temperatures, or dust, etc. Prolonged exposure or extreme temperatures can warp the compact disc.
- Do not stick or write anything on either side of the compact disc. Sharp writing instruments, or the ink may damage the surface.



Cleaning the unit

- To prevent fire or shock hazard, disconnect your unit from the AC power source when cleaning.
- The finish on your unit may be cleaned with a dust cloth and cared for as other furniture. Use caution when cleaning and wiping the plastic parts.
- Mild soap and a damp cloth may be used on the front panel.
- Periodic cleaning of the tape heads, capstan and pinch roller is necessary to maintain good sound reproduction. Clean them after every 100 hours of use or less if playback has deteriorated. Use a cotton swab moistened with head cleaning solution or isopropyl alcohol, then wipe dry with another swab.

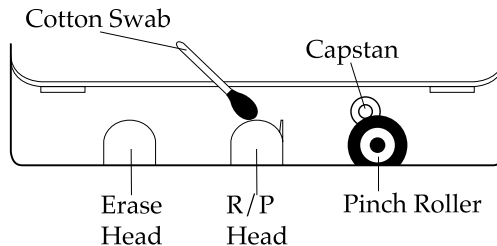

NOTE: Never use metal objects on or near the tape heads. Do not allow any cleaning material to fall into the tape assembly.

TROUBLESHOOTING GUIDE

Should this unit exhibit a problem, check the following before seeking service:

Symptom	Possible Cause	Solution
Cassette Player		
No sound.	FUNCTION switch not set to TAPE.	Slide to the TAPE position.
	Volume at minimum.	Increase volume.
Sound distorted.	Dirty head.	Clean the head.
Speed varies.	Tape old.	Replace the tape.
	Cassette tape worn out.	Replace the tape.
Cassette Recorder		
Will not record.	Erase prevention tab removed.	Cover hole with adhesive tape.
Distorted sound on playback.	Defective tape or dirty tape head.	Replace tape or clean tape head.
Compact Disc Player		
CD Player will not play.	FUNCTION switch not set to CDG.	Slide to the CDG position.
	CD is not installed or installed upside-down.	Insert CD with label side up.
CD skips while playing.	Disc is dirty or scratched.	Wipe disc with cloth or use another disc.
General		
No sound.	Power cord disconnected.	Connect power cord.

Symptom	Possible Cause	Solution
Karaoke		
Some vocals are still present when VOCAL control is set to High.	Using non-CD+G CD.	Use CD+G CD.
	Backup vocals are supposed to be included.	This is normal, only the main vocal(s) are to be reduced.
Feedback is heard when singing.	Microphone is too close to unit or MIC Volume is too high.	Move microphone away from unit or decrease MIC Volume.
Words do not appear on TV screen.	Using non-CD+G CD.	Use CD+G CD.
	Connections not done properly.	Connect to TV properly.

**FOR ADDITIONAL SET-UP OR OPERATING ASSISTANCE, PLEASE VISIT OUR WEBSITE AT
WWW.MEMOREXELECTRONICS.COM
OR CONTACT CUSTOMER SERVICE AT 1-800-919-3647.**

PLEASE KEEP ALL PACKAGING MATERIAL FOR AT LEAST 90 DAYS IN CASE YOU NEED TO RETURN THIS PRODUCT TO YOUR PLACE OF PURCHASE OR MEMOREX.

FOR PARTS AND ACCESSORIES, CONTACT FOX INTERNATIONAL AT 1-800-321-6993.

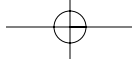

SPECIFICATIONS

GENERAL:

Power Source 120V, 60Hz AC
 Speaker Impedance 8 Ohms
 Dimensions 13 (W) x 15.75 (H) x 9.75 (D) Inches
 Weight 9.5 lbs
 Output Power..... 7W@10%THD

CASSETTE SECTION:

Tape Standard Normal Bias Cassette Tape
 Frequency Response..... 125–6300Hz
 Wow & Flutter 0.35% WRMS

CD SECTION:

Disc Diameter 4.72" (120mm)
 3.15" (80mm) Single CD
 Optical Source..... Semiconductor Laser
 D/A Conversion..... XX

Specifications are subject to change without notice.

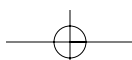
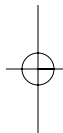
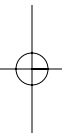

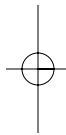
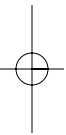

Memcorp, Inc.
Weston, FL
Printed in Hong Kong

Visit our website at www.memorexelectronics.com

