

## **D6015TM SERIES MEDICAL MONITOR**

D6015TM 15" XGA

D6015TM;TS 15" XGA, SAW TOUCHSCREEN

D6015TM;TR 15" XGA, RESISTIVE TOUCHSCREEN



*Planar Systems, Inc. © 2000*

*“Planar” and “The Definition of Quality” are registered trademarks of Planar Systems, Inc. “ELO” is a registered trademark of Elo TouchSystems, Inc., “GCX” and “GCX Instrument Mounting Systems” are registered trademarks of GCX Corporation. All other trademarks are the property of their respective owners.*

*This document is subject to change without notice. Planar provides this information as reference only. Reference to other vendors’ products does not imply any recommendation or endorsement.*

**Revision Control**

<b>Date</b>	<b>Description</b>
July 2000	Document number OM700-02 (020-0151-00 Rev. C)

# Contents

<b>Planar D6015TM Series Medical Monitor .....</b>	<b>1</b>
Functional Description .....	1
Product Features .....	2
Cleaning Instructions .....	2
Safety Instructions.....	3
Disposal Information.....	3
Symbol Explanations .....	4
Regulatory Compliance.....	4
<i>EU Declaration of Conformity for Medical Applications.....</i>	<i>5</i>
<b>Installation.....</b>	<b>6</b>
Identifying Components .....	7
<i>Front View .....</i>	<i>7</i>
<i>Rear View .....</i>	<i>8</i>
Connecting the Optional Touchscreen .....	9
Positioning .....	9
Adjusting the Viewing Angle.....	10
Connecting AC Power.....	10
Connecting Video .....	11
Connecting Optional Stereo Speakers.....	11
Power Management System.....	12
<b>The Display Controls.....</b>	<b>13</b>
Adjusting the Medical Monitor's Display.....	14
<i>On-Screen Display Lockout.....</i>	<i>14</i>
<i>OSD Main Menu.....</i>	<i>15</i>
Quick Adjustment Functions.....	17
Power Switch .....	17
<b>Technical Information.....</b>	<b>18</b>
Planar D6015TM Series Medical Monitor Specifications .....	18
Video Modes.....	19
Connectors .....	20
<i>DC Input .....</i>	<i>20</i>
<i>Video Input .....</i>	<i>20</i>
<i>Audio Port.....</i>	<i>20</i>
<i>Touch Port.....</i>	<i>20</i>
<b>Mechanical Outline Drawings .....</b>	<b>21</b>
<b>Troubleshooting Procedures.....</b>	<b>23</b>
<i>PROBLEM: No Signal Coming .....</i>	<i>23</i>
<i>PROBLEM: Display is Unclear and Unstable .....</i>	<i>23</i>
<i>PROBLEM: Signal Over Supported Range.....</i>	<i>24</i>
<i>PROBLEM: There is No LCD Display .....</i>	<i>24</i>
<b>Description of Warranty .....</b>	<b>25</b>
<i>Commencement and Duration of Warranty.....</i>	<i>25</i>
<i>Place of Repair or Replacement.....</i>	<i>25</i>
<i>Limitation of Warranty .....</i>	<i>25</i>
<i>Installation.....</i>	<i>26</i>
<i>Technical Assistance.....</i>	<i>26</i>
<i>Repair Service.....</i>	<i>26</i>
<b>Ordering Information .....</b>	<b>27</b>
<b>Figures</b>	

Figure 1: Controls and Front View .....	7
Figure 2: Monitor, Rear Ports .....	8
Figure 3: Connecting the Optional Touchscreen Cable .....	9
Figure 4: Screen Angle Settings.....	10
Figure 5: Connecting Power to the Monitor.....	10
Figure 6: Connecting the Monitor to Your System .....	11
Figure 7: Connecting the Stereo Speakers .....	11
Figure 8: Monitor Display Controls.....	13
Figure 9: Buttons to Press for OSD Lockout .....	14
Figure 10: The OSD Main Menu .....	15
Figure 11: GCX/VESA Mounting Option .....	21
Figure 12: Desk Stand Option.....	22

# Planar D6015TM Series Medical Monitor

The Planar D6015TM Series Medical Monitor is a 15-inch XGA monitor designed to be versatile, ergonomic, and easy to use. It is capable of displaying most video standards from 640x480 (VGA) to 1024x768 (XGA). The digital controls located on the front panel allow you to easily adjust the monitor's display parameters using the On-Screen Display (OSD) menus.

Using either a VESA/GCX Instrument Mounting System or compatible mounting plate or an optional desk stand, the monitor's small footprint allows you more room in your workspace for other peripherals. The two stereo speakers let you further expand your computer's multimedia capabilities by connecting your system's audio-out port to the monitor's audio-in port.

The architecture of the Planar D6015TM Series Medical Monitor incorporates an active matrix LCD (AMLCD) panel that produces a clear display with low radiation emission, greatly reducing the radiation-related health concerns associated with CRT monitors.

## Functional Description

The Planar D6015TM Series Medical Monitor consists of a low-profile molded plastic monitor head, video and audio cables, and a power supply. Options include a Surface Acoustic Wave or Resistive touchscreen with interface cable. The display shows 262,144 colors with a pixel matrix of 1024 columns by 768 rows.

The monitor is compatible with standard analog computer video signals. It is connected to the host computer through a standard 15-pin VGA connector on the bottom of the monitor.

The monitor automatically adjusts to applied video and synchronization signals to provide a stable, centered display. Additionally, user controls for brightness and tuning are located on the front of the monitor.

The monitor is certified by TÜV Rheinland according to IEC/EN60601-1:1990 +A1 + A2 for sale to the medical market. The monitor is certified by CSA International to medical standards C22.2 No. 601.1-M1990 (C US Mark) (equivalent to UL2601). The monitor is also CE marked for sale into the European Community for integration or use with medical products.

## Product Features

- Display Type: Color Active Matrix LCD
- Control Buttons:
  - Function select up and Function select down (▲ and ▼)
  - Adjustment increase and Adjustment decrease (⊕ and ⊖)
  - Power on/off (ⓘ)
- Adjust speaker volume directly with the Adjustment increase/decrease buttons.
- Indicators:
  - On-Screen Display “OSD” function
  - Power LED indicator is lit when the monitor is on and blinking when the monitor is in power-save/standby mode
- Display Formats:
  - VGA, SVGA, and XGA
  - VESA DDC1 and DDC2B Plug and Play Functions
  - NEC PC98
  - APPLE MAC
  - 1024x512 (special)

## Cleaning Instructions

The D6015TM Series Monitors will continue to operate normally while being cleaned in a fashion normal for a hospital environment. This includes cleaning with a damp (wrung out), mild soapy cloth. Protection from various chemicals used for cleaning, and protection from liquids consistent with these cleaning procedures is provided in accordance with IPX1 rating per IEC/EN60529.

The D6015TM Series Monitors will withstand non-abrasive cloths and cleaning solutions used in hospitals for like equipment. This is typically warm water and mild detergent for all surfaces or 70% IPA for the touchscreen surface. Possible chemicals include:

- 70% isopropyl alcohol
- 1.6% aqueous ammonia
- Cidex (2.4% glutaraldehyde solution)
- Sodium Hypochlorite (bleach) 10%
- “Green soap” USP
- 0.5% Chlorhexidine in 70% isopropyl alcohol
- Ovation®
- Formula 409®
- Fantastic®
- WexCide®

To clean the screen, do not spray liquid cleaners directly onto the unit. Stand away from the monitor and spray cleaning solution onto a cloth. Without applying excessive pressure, clean the screen with the slightly dampened rag.

## Safety Instructions

- Do not place your monitor near a window. Exposing the monitor to rain, water, moisture, or constant direct sunlight can severely damage it.
- Do not place anything on top of the monitor-to-computer signal cord. Make sure the cord is placed in an area where it will not be stepped on.
- Do not apply excessive pressure to the screen. Excessive pressure may cause permanent damage to the display.
- The monitor and power supply units have no user serviceable parts inside. Refer all servicing to qualified personnel to maintain warranty.
- When using the monitor with the desk stand option, it must be placed on a flat surface that is horizontal to  $\pm 5^\circ$ .
- Do not cover or obstruct the venting holes on the back of the monitor.
- Store the monitor within  $-20^\circ$  to  $+65^\circ$  Celsius. Storing your monitor outside this range could result in permanent damage. Please store in the original shipping carton.
- If any cord or cable is frayed or damaged, immediately replace it with another of the same type and rating as supplied by Planar. See "Ordering Information" for part numbers. Safety and regulatory listings and certifications do not apply if other cables are used.
- If the monitor has been exposed to liquid, or it has been dropped, or the case has been damaged, it may pose a shock or fire hazard; immediately unplug it and contact customer service for assistance.
- Use only Planar Power Adapter (model PPA4512UM) which has been tested and approved for use with this monitor product. See "Ordering Information" for part numbers.  
**Caution: AC Adapter must be plugged into a GROUNDED power outlet.**
- When cleaning the power adapter, use a cloth dampened with liquid cleaners on the outside of the enclosure only. Do not immerse product in liquid or a safety hazard could arise during use.
- Do not use the power adapter in the presence of flammable anesthetics.

## Disposal Information

This monitor contains cold cathode fluorescent lamps which contain a maximum of 12 mg (3 mg per lamp) of mercury. Please follow local ordinances or regulations for its disposal.

## Symbol Explanations

Following are explanations of the symbols found on the monitor or power supply.



Indicates proof of conformity to applicable European Economic Community Council directives and to harmonized standards published in the official journal of the European Communities.



Tested and certified by CSA to C22.2 N0. 601.1-M1990. If this mark appears with the indicators “C” and “US” the product is certified for both the U.S. and Canadian markets, to the applicable U.S. and Canadian standards.



Tested to comply with FCC Class B standards.



Indicates that the monitor has been designed to meet low radiation standards.



Consult accompanying documents.



Tested and certified by TÜV Rheinland in accordance with EN60601-1.



Indicates protective earth ground.



For indoor use only.



Identifies the socket for headphones.

## Regulatory Compliance

This monitor has been tested to comply with IEC/EN 60601-1 and IEC/EN 60601-1-2 by TÜV Rheinland and is certified by CSA International to medical standards C22.2 No. 601.1-M1990 (C US Mark).

Because many medical offices are located in residential areas, this monitor, in addition to the medical requirements, has also been tested and found to comply with the limits for FCC Class B computing devices in a typically configured system. It is the system integrator or configurer’s responsibility to test and ensure that the entire system complies with applicable EMC laws.

Planar Systems, Inc. has made great efforts to support the medical device industry, in particular medical device manufacturers and medical device system integrators. We offer state of the art color displays that are compliant with worldwide accepted medical device safety standards, and for the European market, CE-marked displays based on compliance with council directive 93/42/EEC – commonly referred to as the Medical Device Directive (MDD). The following is a summary of our qualification of these displays as it relates to compliance with the MDD.

The European Medical Device Directive requires that the intended use of a device be defined. The intended use of these displays is “to display alpha numeric, graphic and image data as inputted from any type of medical device.” These displays do not provide a measurement function in any way and it is the device/systems manufacturer’s responsibility to verify its function in the integrated device or system.

The display was classified as required by the MDD according to Annex IX of the directive and the MEDDEV guidance available at the time of classification. Because the display uses electrical energy and has no direct patient connections and – by itself – no medical utility, the display is



classified according to Rule 12 as an MDD Class I device – component or accessory. The MDD sets out that manufacturers of Class I medical devices or accessories shall satisfy the requirements in regards to design and manufacturing controls, i.e. the applicable assessment route to be used for CE-marking under the MDD and shall carry the CE-mark according to Annex XII of the directive, with no notified body annotation.

The applicable safety standards for a MDD Class I display are IEC/EN 60601-1: 1990 along with Amendments 1 & 2. To help the medical device designer evaluate the suitability of these displays, Planar has also conducted EMC testing to IEC 60601-1-2 as it can be applied. The display with its power supply alone do not represent a functional medical device. Hence, Planar has configured a minimal operating system that exercised the display. The resulting data is made available to interested parties.

This data is informative data, not certification data. Certification data must be obtained by the device or system integrator according to Article 12 of the MDD titled “Particular procedure for systems and procedure packs”. Paragraph #2 clearly outlines the device or system integrator's responsibility in this matter.

In summary, Planar Systems, Inc. is CE-marking these displays under the Medical Device Directive which establishes compliance to the basic medical safety standards. However, EMC compliance can only be accomplished in the configured medical device or system and is the responsibility of the device or system manufacturer. Planar has the necessary documentation such as IEC 60601-1 notified body and other third party test reports and certifications, a risk/hazard analysis, an essential requirements checklist, and Planar's EC declaration of conformity.

Planar Systems, Inc. located in Beaverton, Oregon – USA is the manufacturer of these displays in the meaning of the directive. As required by the MDD in Article 14, Planar Systems, Inc. not residing in the EEA, has a European Representative, Planar Systems, Inc. – Espoo, Finland.

It is the opinion of Planar Systems, Inc. that registration of putting into commerce is the responsibility of the medical device/system manufacturer and Planar supports this requirement by providing an EC declaration of conformity. If Planar supplies a display to an end user, rather than a device manufacturer, it is the end users responsibility to assure continued compliance of the system in which the display is being integrated with the MDD.

For Vigilance reporting as required under Article 10 of the MDD, Planar Systems, Inc. will provide any information requested by a competent authority to support any reported incident investigation by such an authority.

## **EU Declaration of Conformity for Medical Applications**

A Declaration of Conformity has been filed for this product. A sample of this document may be found in the addendum which accompanied this manual. For a copy of the Declaration of Conformity document, please contact Planar Systems, Inc. and request document number 001-0014-00 “Declaration of Conformity”.

# Installation

Before you unpack your monitor, prepare a suitable workspace. You need a stable and level surface near a grounded wall outlet in an area which is relatively free of glare from sunlight or other sources of bright light. The monitor is cooled by natural convection (it has no fan). For optimum performance, do not block the cooling vents.

While unpacking the monitor, inspect it and other package contents for shipping damage that could cause a fire or shock hazard. Immediately report any shipping damage to the carrier or transportation company and contact customer service for assistance. Keep all packing material in case you need to ship or store the monitor in the future or in case of return.

After you unpack the monitor, make sure the following items are included (refer to “Ordering Information” for part numbers):

- Monitor with 1.5 meter (5 ft.) monitor-to-computer video cable
- 1.5m (5 ft.) stereo audio cable
- AC adapter with cable. (CAUTION: AC Adapter must be plugged into a GROUNDED power outlet.) Output power: 12Vdc to a 4 pin male locking mini-din connector.
- Power cord (medical grade) which connects from AC mains to AC adapter.
- Touchscreen cable if monitor has touchscreen option.
- This operations manual

---

**Note:** Your system provider may offer alternative cords or cables depending on the installation requirements and local geography issues.

---

## Identifying Components

### Front View

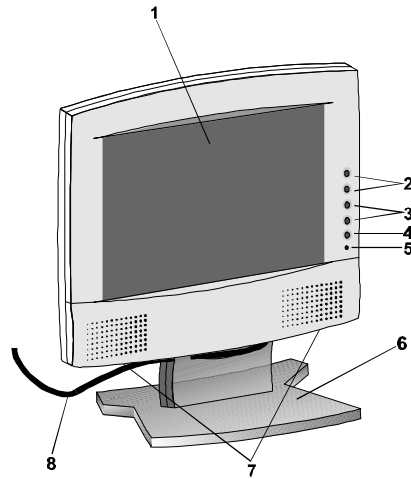

**Figure 1: Controls and Front View**

1. **Monitor Screen**

The screen is capable of producing most display standards from 640 x 480 VGA to 1024 x 768 XGA. A VESA mounting plate (not shown) is secured to the rear of the monitor and is compatible with GCX Instrument Mounting Systems or other standard VESA swing arms or desk stands.

2. **Function Buttons**

When the On-Screen Display (OSD) main menu is active, press either of these two buttons to scroll through the menu of functions (see page 15). See “Quick Adjustment Functions” on page 17 for additional features of these buttons.

3. **Adjustment Buttons**

When the OSD main menu is active, these two buttons allow you to adjust the selected function to accommodate your specific working environment. Press the upper and lower button to increase or decrease the setting of the selected function. See “Quick Adjustment Functions” on page 17 for additional features of these buttons.

4. **Power Switch / On-Screen Display (OSD)**

Push the power switch to turn the monitor on. When the monitor is on, push the switch momentarily to toggle the OSD menu on and off. Push and hold the switch for two seconds to turn the monitor off.

5. **Power-On Indicator**

This LED indicator is steadily lit when the power is on and video is being supplied. The LED indicator will blink when the monitor is in power-saving mode.

6. **Optional Desk Stand**

The monitor stand supports the monitor for use on a desktop.

7. **Stereo Speakers**

Built-in stereo speakers for computer sound. Connect the computer’s audio-out port to the monitor’s audio-in port using the supplied audio cable.

8. **Video Signal Cable**

This cable connects the monitor to the computer’s VGA port. If you use the optional monitor stand, the cable loops through the hole in the stand as illustrated in Figure 1.

## Rear View

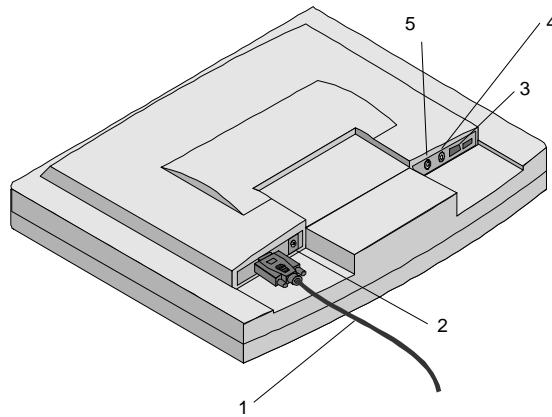

**Figure 2: Monitor, Rear Ports**

1. **VGA Cable**  
This 1.5 meter (5 ft.) cable has a 15-pin D-Sub VGA connector used to connect to your computer's VGA port.
2. **Power Input Port** (locking/latching mini-Din 4-Pin)  
Connect the low-voltage cable from the power adapter to this port.
3. **9-Pin D-Sub Connector for Optional Touchscreen**  
Connect the cable provided with the touchscreen package to this port and to your system's 9-pin serial port.
4. **Audio Line-in Port**  
Connect the system's audio line-out to this port to listen to the system's audio on the monitor's stereo speakers. The system's CD-ROM line-out can also be connected to this port.
5. **Stereo Headphone Port**  
Connect stereo headphones or powered external speakers to this port to listen to the system's audio output.

**Note:** When headphones are plugged in, the stereo speakers are disabled.

## Connecting the Optional Touchscreen

If your monitor has this optional feature, connect the monitor's 9-pin D-sub serial port to your computer's 9-pin RS232 serial port using the cable which came with the optional touchscreen package.

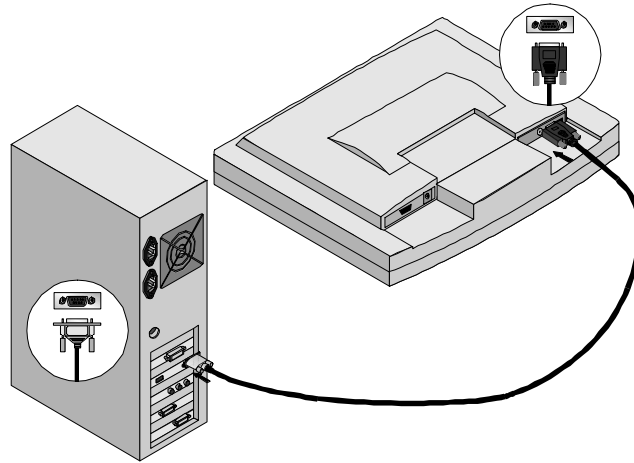

**Figure 3: Connecting the Optional Touchscreen Cable**

Next connect the male end of the RS232 cable provided with the optional touchscreen package to the 9-pin serial port at the back of the monitor (refer to Figure 3).

---

**Note:** Please contact your system provider or ELO TouchSystems at [www.elotouch.com](http://www.elotouch.com) for the touchscreen driver and installation instructions. From the Download Drivers page, select the appropriate platform and download the driver file and the instruction file. Following driver software installation, you will need to calibrate your touchscreen to the computer following the procedure provided by ELO. You can also contact ELO by telephone at +1(800) 557 1458 extension 4607, or fax +1(510) 790-0627.

---

## Positioning

When positioning the monitor, make sure the main ports and sockets are easily accessible. Mount the monitor on a GCX Instrument Mounting Systems or other standard VESA swing arm or desk stand, or on an optional desk stand. With the monitor stand, you need a flat and stable surface (horizontal to  $\pm 5^\circ$ ) with good ventilation.

Position the monitor to avoid glare from sunlight or other sources of bright light. Excessive exposure to heat, moisture, or direct sunlight can damage the monitor.

## Adjusting the Viewing Angle

The Planar D6015TM Series Medical Monitor was designed to allow adjustment to a comfortable viewing angle. The monitor's angle settings range from  $-5^{\circ}$  to  $+25^{\circ}$  on the optional desk stand (Figure 4).

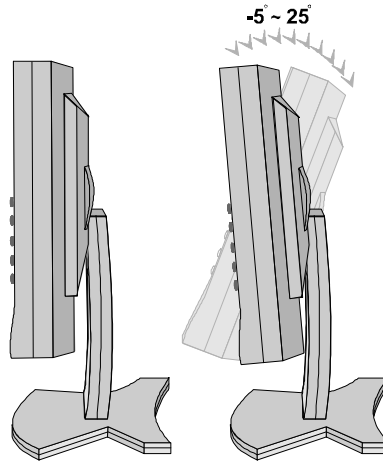

**Figure 4: Screen Angle Settings**

---

**Caution:** Do not force the monitor past its maximum extension in either direction or you may damage the monitor or the desk stand.

---

## Connecting AC Power

Plug the female end of the mains AC power cord into the AC power adapter, then plug the power connector of the adapter into the power port on the monitor. The port (12 Vdc) is located at the rear of the monitor near the signal cable (Figure 5). Press firmly to engage the protective lock mechanism. A light snap should be felt to ensure proper engagement.

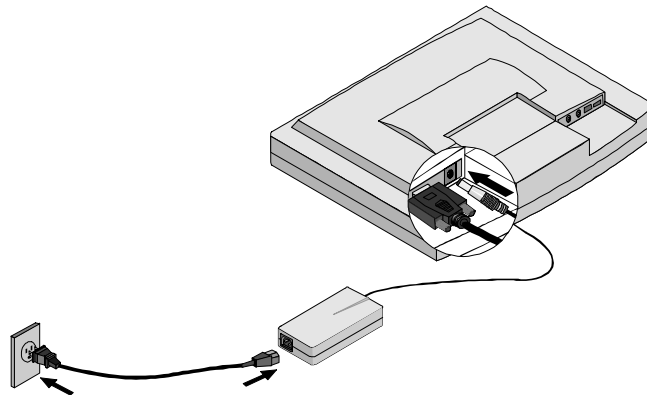
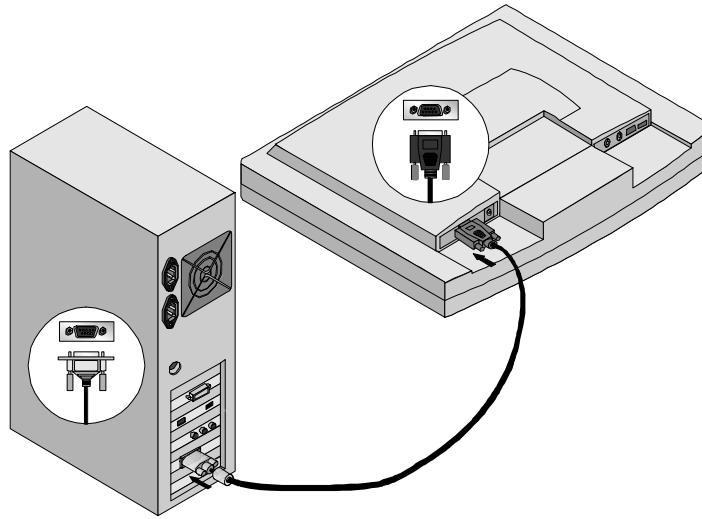

**Figure 5: Connecting Power to the Monitor**

Plug the male end of the supplied power cord into a grounded wall socket. For added protection, we recommend use of a surge protector between the AC adapter and the electrical wall outlet to prevent sudden current variations from reaching the monitor.

## Connecting Video

With the power to your computer and the monitor off, connect the supplied video cable from the monitor to the computer's VGA port (Figure 6).

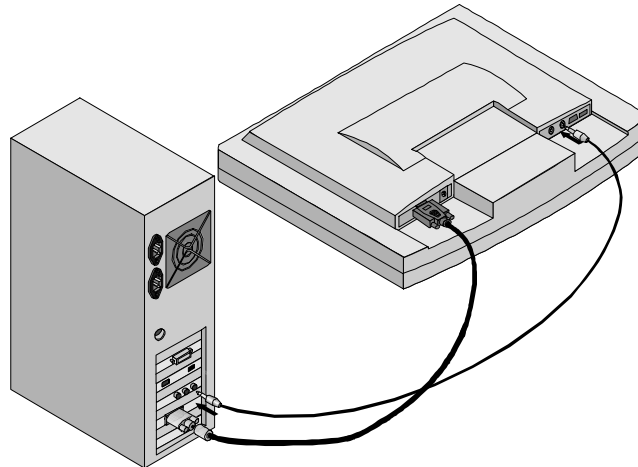

**Figure 6: Connecting the Monitor to Your System**

Make sure the VGA cable connector is securely connected to the VGA port on your computer. Tighten the connecting screws to ensure a secure connection. Turn the monitor on first, then turn on the computer. The LED on the monitor will flash until it receives a video signal from the system.

## Connecting Optional Stereo Speakers

Connect the supplied audio cable to the line-out port of your computer's audio card. Next connect the other end of the audio cable to the monitor's line-in port (Figure 7, shown with video cable also attached).



**Figure 7: Connecting the Stereo Speakers**

Adjust the sound volume of the stereo speakers by using either the speaker volume control function on the On-Screen Display (OSD) or the Adjustment increase and decrease buttons (see Figure 8) on the front of the monitor.

**Note:** Planar does not recommend using the audio from the monitor as your exclusive audio source in medical applications.

## Power Management System

The Planar D6015TM Series Medical Monitor complies with the VESA DPMS power management proposal. The VESA DPMS proposal provides four phases of power-saving modes by detecting the horizontal or vertical sync signal as shown in the table below.

<b>Mode</b>	<b>DC Input Power (monitor only)</b>	<b>AC Input Power (incl. AC adapter)</b>	<b>LED Status</b>
On (with audio)	30.0 W max.	40 W max.	Steady Green
On (without audio)	28.0 W max.	37 W. max.	Steady Green
Standby	4.5 W max.	6 W max.	Blinking Green
Suspend	4.5 W max.	6 W max.	Blinking Green
Off	4.5 W max.	6 W max.	Blinking Green







When the monitor is in power saving mode or detects an incorrect timing, the screen will be blank and the power LED indicator will blink.



# The Display Controls

Located on the front of the Planar D6015TM Series Medical Monitor are five buttons for operating the monitor and accessing the functions on the On-Screen Display (OSD).

**Button**

- |                         |                                                                                   |                             |
|-------------------------|-----------------------------------------------------------------------------------|-----------------------------|
| 1. Function select up   |  |                             |
| 2. Function select down |  |                             |
| 3. Adjustment increase  |  |                             |
| 4. Adjustment decrease  |  |                             |
| 5. Power ON/OFF         |  |                             |
| 6. Power LED            |  | (LED: off, on, or flashing) |

**Figure 8: Monitor Display Controls**

## Adjusting the Medical Monitor's Display

Using the monitor's On-Screen Display (OSD), you can adjust the contrast, brightness, display position, display clarity, and color temperature of the display. You can also adjust the stereo speaker volume and set OSD parameters. Access the OSD any time both your computer and monitor are on. If your computer is off or in power saving mode, the OSD is inaccessible.

The OSD makes adjusting the display settings quick and easy. When the OSD is on, use the Function buttons (▲ and ▼) to scroll through the menu items. Use the Adjustment buttons (⊕ and ⊖) to advance to the next sub-menu and make changes to the selected menu item (Figure 10).

### On-Screen Display Lockout

To “lock” the OSD to prevent accidental changes to your settings, hold in the 2nd, 3rd, and 4th buttons (▼, ⊕, and ⊖) simultaneously to lock—and later unlock—all Function adjustments of the monitor (Figure 9).

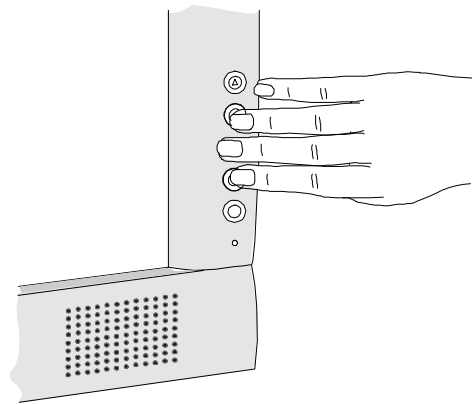

**Figure 9: Buttons to Press for OSD Lockout**

If any OSD button is depressed while the OSD is in locked mode, a message will appear on the screen that says “OSD Locked.” To unlock the OSD, hold in the 2nd, 3rd, and 4th buttons (▼, ⊕, and ⊖) simultaneously again.

## OSD Main Menu

To access the OSD Main Menu, briefly press the Power button (see Figure 8). The following screen appears:

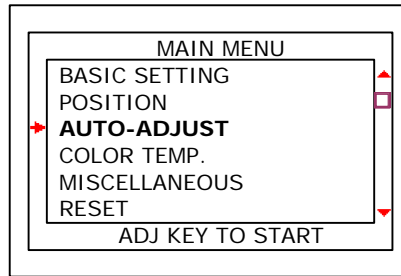

Figure 10: The OSD Main Menu

The control functions are grouped into five categories as shown on the Main Menu in Figure 10. Continue pressing the up and down Function buttons (▲ and ▼) to scroll through the menu items. Use the Adjustment buttons (⊕ and ⊖) to enter the sub-menu of each function group. Each item is described below.

Main Menu	
<b>BASIC SETTING</b>	Change the contrast, brightness, video level, gamma, etc.
<b>POSITION</b>	Change display size, position, clock and phase, etc.
<b>AUTO-ADJUST</b>	Automatically adjust the picture quality and alignment. It is recommended you use this function in Windows or similar environments (this function does not work in the interlaced modes).
<b>COLOR TEMP.</b>	Control the display colors.
<b>MISCELLANEOUS</b>	Control audio volume and OSD position, and provide information on display modes.
<b>RESET</b>	Set display parameters to the factory set default values.
<b>EXIT</b>	Exit OSD Menu.

Basic Setting	
<b>CONTRAST</b>	Adjust the contrast level of the display.
<b>BRIGHTNESS</b>	Adjust the brightness level of the display.
<b>VIDEO LEVEL</b>	Select the matching input signal voltage level (0.7Vpp or 1.0Vpp).
<b>GAMMA</b>	Select a suitable color representation.
<b>FRAME</b>	Select one of 64 border colors to show when display is not in full-screen size. (Not available in all modes.)
<b>TO MAIN MENU</b>	Return to Main Menu.

<b>Position</b>	
<b>CLOCK</b>	Adjust the display pixel alignment.
<b>PHASE</b>	Adjust the screen display for focus and clarity.
<b>DEFAULT SIZE</b>	Expand the display to full screen. (Not available in all modes.)
<b>NATIVE SIZE</b>	Adjust display to original size. (Not available in all modes.)
<b>H-POSITION</b>	Adjust the display position horizontally.
<b>V-POSITION</b>	Adjust the display position vertically.
<b>H-SIZE</b>	Horizontally adjust display size. (Not available in all modes.)
<b>V-SIZE</b>	Vertically adjust display size. (Not available in all modes.)
<b>GRAPH/TEXT</b>	Select Graph or Text expansion method while in 720x400 or 640x480 modes. (Not available in all modes.)
<b>TO MAIN MENU</b>	Return to Main Menu.

<b>Color Temp. Menu</b>	
<b>9300° K</b>	Set the color temperature of white to 9300° Kelvin.
<b>6500° K</b>	Set the color temperature of white to 6500° Kelvin.
<b>USER</b>	Enable the “User Color” field and adjust individual RGB levels.
<b>TO MAIN MENU</b>	Return to Main Menu.

<b>Miscellaneous Menu</b>	
<b>AUDIO VOLUME</b>	Adjust the audio volume of the monitor’s speakers (on models with built-in speakers).
<b>OSD H-POSITION</b>	Adjust the horizontal position of the OSD menu.
<b>OSD V-POSITION</b>	Adjust the vertical position of the OSD menu.
<b>DISPLAY MODE</b>	Display the resolution and frame rate of the current screen display.
<b>F/W VERSION</b>	Display the firmware version of the monitor.
<b>TO MAIN MENU</b>	Return to Main Menu.

<b>Reset Menu</b>	
<b>BASIC SETTING</b>	Set the function parameters in the Basic Setting Menu to the default values.
<b>POSITION</b>	Set the function parameters in the Position Menu to the default values.
<b>COLOR TEMP.</b>	Set the function parameters in the Color Temp. Menu to the default values.
<b>MISCELLANEOUS</b>	Set the function parameters in the Miscellaneous Menu to the default values.
<b>ALL FUNCTIONS</b>	Set all function parameters to the default values.
<b>TO MAIN MENU</b>	Return to Main Menu.

## Quick Adjustment Functions

When the OSD Main Menu is not active, the following functions are available for quick adjustment.

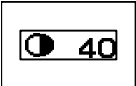
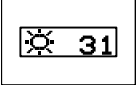
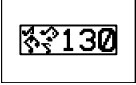
	Press the upper Function button (▲) to enable the small Contrast icon. Use the Adjustment buttons to increase or decrease the contrast level.
	Press the lower Function button (▼) to enable the small Brightness icon. Use the Adjustment buttons to increase or decrease the Brightness level.
	Press the upper or lower Adjustment button (+ or -) to enable the small Volume icon. Use the Adjustment buttons to increase or decrease the volume.

## Power Switch

The Power button (ⓘ) is used for both power on/off and OSD menu on/off:

- Press the Power button to turn on the monitor. Press the Power button and hold it in for two seconds to turn the monitor off.
- When the monitor is on, press the Power button briefly to turn the OSD menu on. Press it again briefly to turn the menu off.

# Technical Information

## Planar D6015TM Series Medical Monitor Specifications

<b>Display Panel</b>	15-inch (381 mm) XGA active matrix LCD (AMLCD)
<b>Display Colors</b>	262,144
<b>Dimensions:</b>	
w/bracket	408 x 333 x 85 mm (W x H x D)
w/desk stand	408 x 387 x 175 mm (W x H x D)
<b>Weight:</b>	
w/bracket	4.9 kg (10.8 lbs.)
w/desk stand	6.9 kg (15.2 lbs.)
<b>Display Area</b>	304.1 x 228.1 mm (W x H), 15inch (381 mm) diagonal
<b>Response:</b>	
Wht>Blk	10 ms typical
Blk>Wht	15 ms typical
<b>Viewing Angle:</b>	H or V ±80 ° typ., contrast ratio >10
<b>Contrast Ratio</b>	300:1 typical
<b>Brightness:</b>	
Non-touch	228 cd/m <sup>2</sup> typical
w/SAW	225 cd/m <sup>2</sup> typical
w/RT	200 cd/m <sup>2</sup> typical
<b>Pixel Pitch</b>	0.297 x 0.297 mm
<b>Reliability</b>	40k hours MTBF, excluding backlight
<b>Video Interface</b>	VGA-compatible analog RGB (15-pin D-Sub), Separate Sync. / Composite Sync.
<b>Scanning Frequency</b>	24-61 kHz (horizontal), 50-90 Hz (vertical)
<b>Factory Preset Modes</b>	25
<b>Power Management</b>	Meets VESA DPMS, EPA
<b>Power Consumption</b>	30 W on, 4.5 W standby (not including power adapter)
<b>Net Weight</b>	6.9 kg, 15.2 lb
<b>Power Supply:</b>	12V / 3A, 36W, Input power 100 Vac to 240 Vac at 50 to 60 Hz, AC Adapter (external)
<b>Options</b>	Desk Stand, Resistive Touchscreen, SAW Touchscreen
<b>Temperature:</b>	
Operating	0 to 40 °C
Non-operating	-20 to 65 °C
<b>Humidity:</b>	
Operating	10 to 90% RH non-condensing, per IEC 68-2-3
Non-operating	0 to 95% RH non-condensing, per IEC 68-2-30
<b>Altitude</b>	0 to 10k ft Operating, per IEC 68-2-13, 4 hr 0 to 40k ft. Non-operating, per IEC 68-2-13, 4 hr
<b>Shock</b>	50g, 11ms duration. Operating/Non-operating. Half sine with 3 shocks on each of six axes per IEC 68-2-27.
<b>Audio</b>	Two 1-Watt speakers with amplifier
<b>Regulatory</b>	TÜV Safety Mark, CSA (C US Mark), CE Mark-MDD

## Video Modes

The Planar D6015TM Medical Monitor will support 25 video timing modes which were preset at the factory. Those modes not supported will cause the monitor to go into power-saving mode. Once a mode is optimized, there is no need to make any further adjustment as long as the VGA mode remains unchanged. These specifications are subject to change without notice.

Mode	Horiz. Freq. (kHz)	Vert. Freq. (Hz)	Pixel Freq. (MHz)	H/V Sync. polarity	Comment	Mode ID No.
640x400	31.469	70.087	25.175	-/+	VGA-400 Graphic	101
640x400	37.861	85.080	31.500	-/+	VESA-400 Graphic	102
720x400	31.469	70.087	28.322	-/+	VGA-400 Text	103
720x400	37.927	85.039	35.500	-/+	VESA-400 Text	104
640x400	24.830	56.420	21.050	-/-	NEC PC98-400	105
640x400	31.500	70.150	25.197	-/-	NEC PC98-400	106
640x350	31.469	70.087	25.175	+/-	VGA-350	107
640x350	37.861	85.080	31.500	+/-	VESA-350	108
640x480	31.469	59.940	25.175	-/-	VGA-480	109
640x480	35.000	66.670	30.240	-/-	APPLE MAC-480	110
640x480	37.861	72.809	31.500	-/-	VESA-480	111
640x480	37.500	75.000	31.500	-/-	VESA-480-75Hz	112
640x480	43.269	85.008	36.000	-/-	VESA-480-85Hz	113
800x600	35.156	56.250	36.000	+/+	SVGA	114
800x600	37.879	60.317	40.000	+/+	VESA-600	115
800x600	48.077	72.188	50.000	+/+	VESA-600-72Hz	116
800x600	46.875	75.000	49.500	+/+	VESA-600-75Hz	117
800x600	53.674	85.061	56.250	+/+	VESA-600-85Hz	118
832x624	49.730	74.550	57.283	-/-	APPLE MAC-800	119
1024x768	48.363	60.004	65.000	-/-	XGA	120
1024x768	53.964	66.132	71.644	+/+	COMPAC-XGA	121
1024x768	56.476	70.069	75.000	-/-	VESA-768	122
1024x768	60.023	75.029	78.750	+/+	VESA-768-75Hz	123
1024x768	60.240	75.020	80.000	-/-	APPLE MAC-768	124
1024x512	34.380	60.005	46.7568	-/-	SPECIAL	125

## Connectors

### DC Input

Locking or latching 4-pin Mini DIN Receptacle. The vendor P/N is H.C.E. MD00027 or equivalent.

Description	Pin	Pin	Description
+12VDC	1	3	+12VDC
GND	2	4	GND
Shield	Shield		

### Video Input

15 pin D-subminiature connector. The vendor P/N is Aces 85314-1500 or equivalent.

Description	Pin	Pin	Description
Red Video	1	9	NC
Green Video	2	10	Logic Ground
Blue Video	3	11	NC
NC	4	12	SDA (DDC1/2B)
Logic Ground	5	13	H-sync
Red Video Ground	6	14	V-sync
Green Video Ground	7	15	SCL (DDC2B)
Blue Video Ground	8		

### Audio Port

Stereo mini-jack. The vendor p/n is Touke TC38-102-7

Description	Pin	Pin	Description
L-Audio	1	4	NC
R-Audio	2	5	Ground
NC	3		

### Touch Port

9 pin D-subminiature connector.

Description	Pin	Pin	Description
DCD	1	2	DSR
RXD	3	4	RTS
TXD	5	6	CTS
DTR	7	8	RI
Logic Ground	9		



# Mechanical Outline Drawings

All dimensions shown in the following drawings are specified in millimeters.

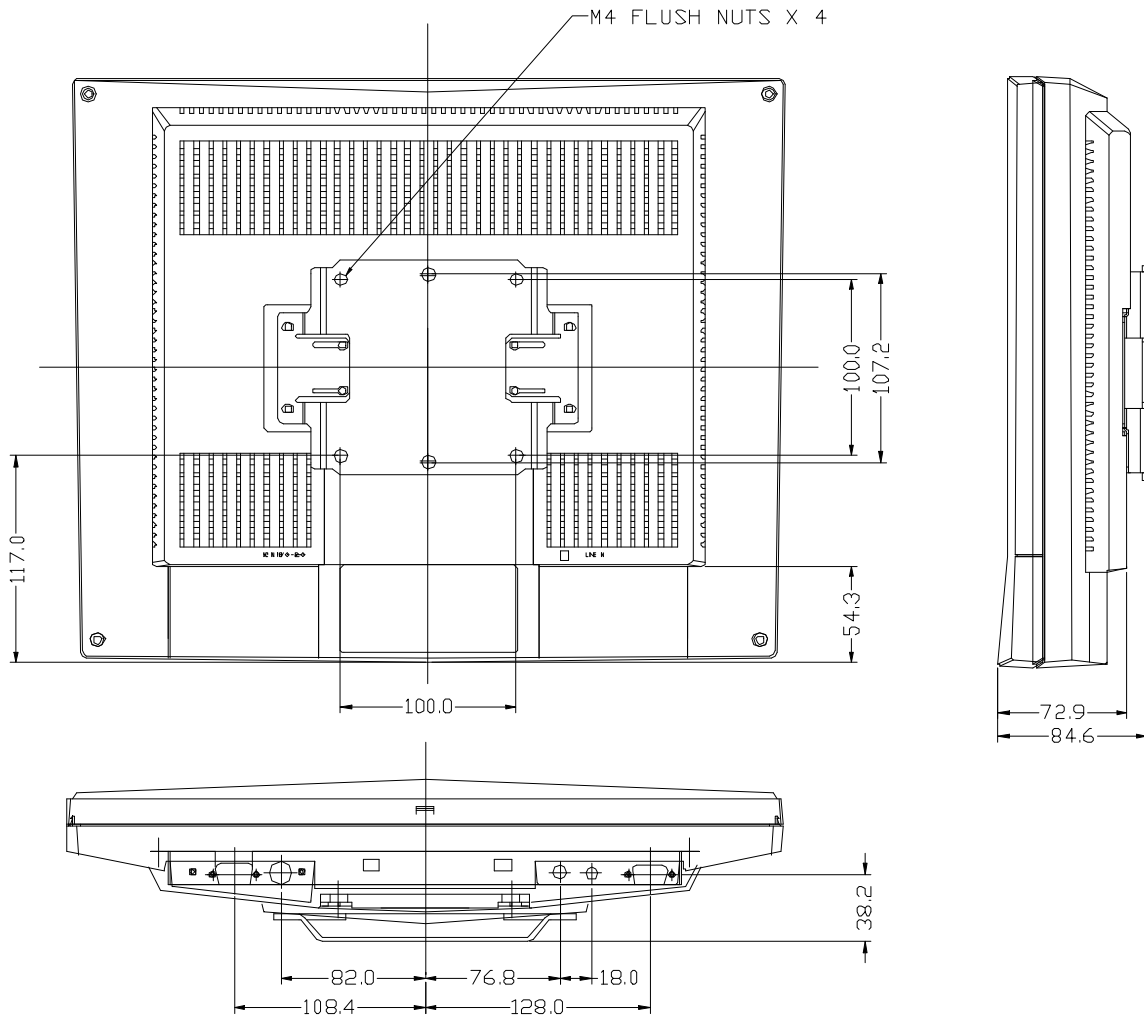

**Figure 11: GCX/VESA Mounting Option**

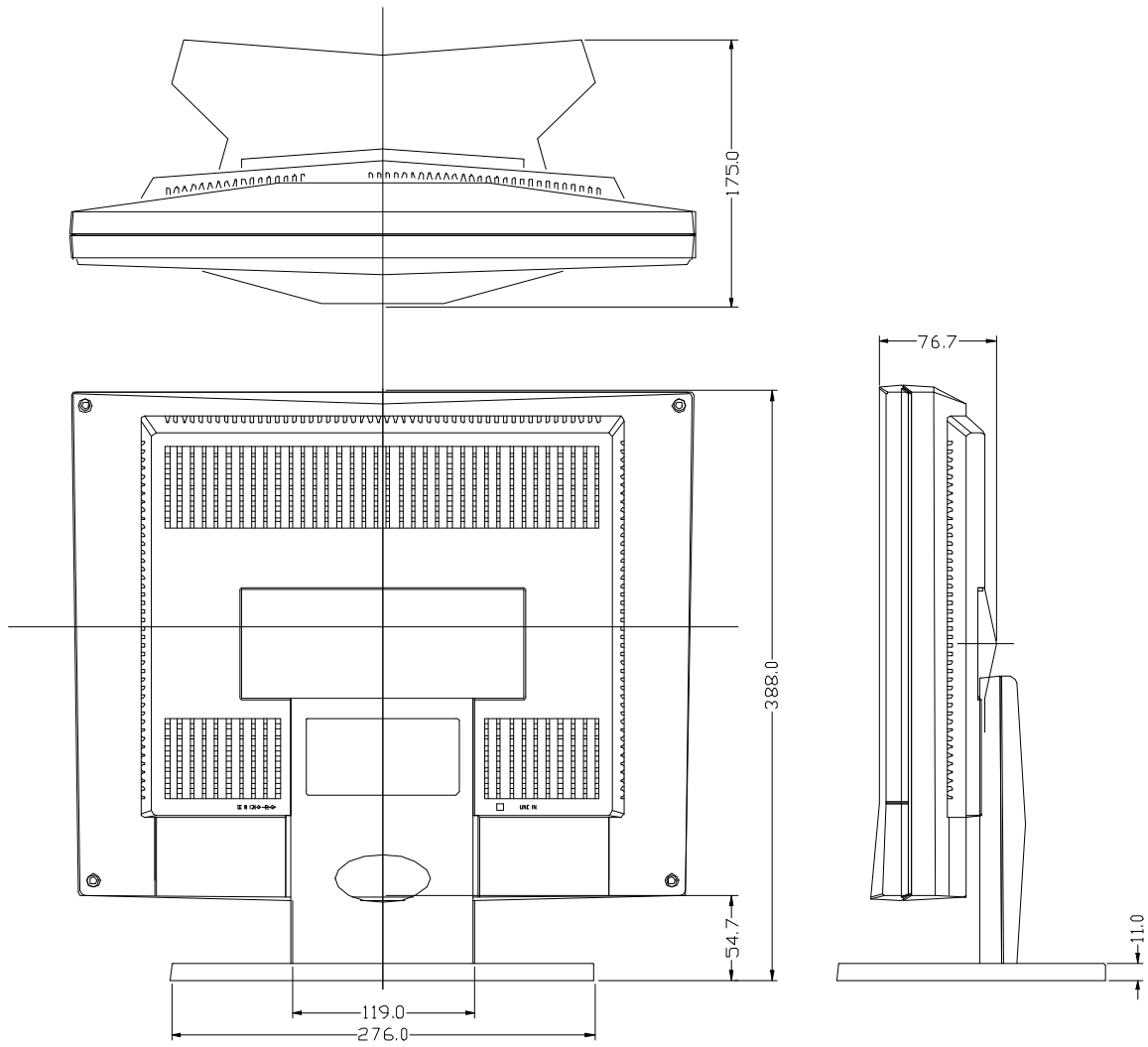

Figure 12: Desk Stand Option

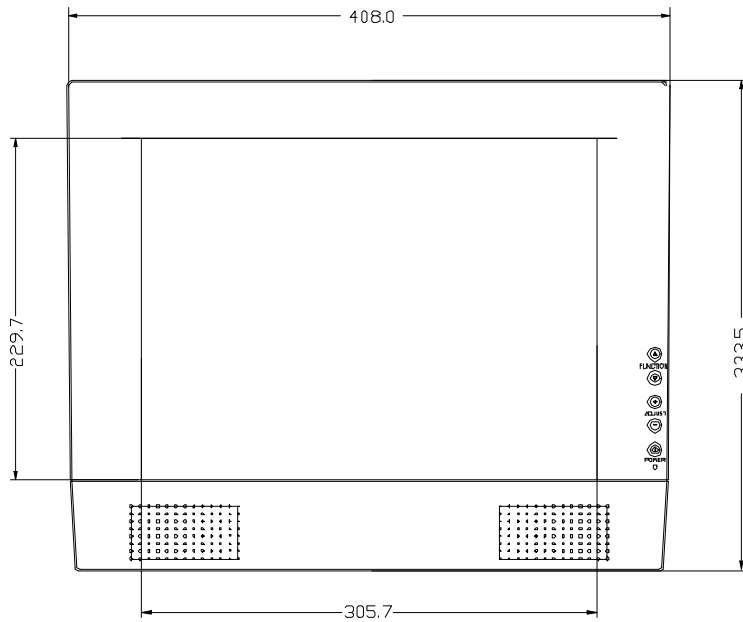

Figure 13: Display Front

# Troubleshooting Procedures

The Planar D6015TM Series Medical Monitor was factory adjusted to standard VGA timing. Due to output timing differences among various VGA cards, you may initially experience an unstable or unclear display when a new display mode or new VGA card is selected. This monitor supports multiple VGA modes. Refer to the “Technical Information” on page 18 for a listing of the factory preset modes supported.

## **PROBLEM: No Signal Coming**

When the monitor is ON and there is no video signal received, the following message will be displayed until the monitor enters power-saving mode:

NO SIGNAL COMING... CHECK SIGNAL CABLE MONITOR WILL ENTER POWER SAVING!!!!
-------------------------------------------------------------------------------------

Check to make sure the video cable is attached to the system. Refer to “PROBLEM: There is No LCD Display” for more information.

## **PROBLEM: Display is Unclear and Unstable**

- It is best to adjust the display using an image of vertical lines. In Windows, load a wallpaper bitmap that has vertical lines in it (or you can select the Windows shut-down screen).
- After you have the wallpaper loaded, open the OSD and select the “Clock” function. Repeatedly press the upper Adjustment button (⬆) until you see vertical dark and light lines across the screen.
- When you can see distinct light and dark vertical bands, repeatedly press and release the lower Adjustment button (⬇) until the distinct bands disappear and you have a clear display.
- Use the Function button (⬆ or ⬇) to choose the “Phase” function to adjust the horizontal display. Repeatedly press and release the upper Adjustment button (⬆) and you will see horizontal dark and light lines appear.
- When you can see distinct light and dark horizontal bands, repeatedly press and release the lower Adjustment button (⬇) until the distinct bands disappear and you have a clear display.

### **PROBLEM: Signal Over Supported Range**

When the signal is out of the monitor's frequency range, the screen display will not be centered and the following message will be displayed:

SIGNAL OVER RANGE! PRESS FUN/ADJ KEY FUN→ H-POSITION ADJ→ V-POSITION
-------------------------------------------------------------------------------

Pan the display picture with the Function and Adjustment control buttons (see page 7).

### **PROBLEM: There is No LCD Display**

1. Make sure the power indicator on the monitor is lit, all connections are secure, and the system is running on a supported video timing mode as described on page 19.
2. If the power LED is not lit, check that the AC power connector is securely connected. If your AC adapter has an LED, verify that the LED is lit. If it is not, contact your dealer for assistance.
3. Turn the monitor off and then turn it back on again. Press the upper Function button (▲) once and then press the upper Adjustment button (⊕) several times. If there is still no display, press the lower Adjustment button (⊖) several times.
4. Connect your system to another external CRT monitor. If your system functions properly with a CRT but it does not function with the flat panel monitor, and the flat panel monitor's power LED is blinking, the output timing of your computer's VGA card may be out of the LCD's synchronous range. Please change to an alternate mode listed in "Technical Information" on page 18 or connect to an alternate VGA source and then repeat steps 1 and 2.
5. In the case of systems with more than one video output, verify that the output to which the monitor is connected is enabled.
6. If your system doesn't function with either the CRT monitor or the flat panel monitor, contact technical support at your system provider.

## Description of Warranty

Planar Systems (Planar) warrants that the goods sold hereunder will be free of defects in materials and workmanship, and such goods will substantially conform to the specifications furnished by Planar, and to any drawings or specifications furnished to Planar by the Buyer if approved by Planar. This warranty shall be effective only if Planar receives notice of such defect or nonconformance during the period of the warranty. Planar's sole and exclusive liability for breach of warranty shall be, at Planar's option, to repair or replace the Planar product(s) with refurbished units or provide a credit to buyer in the amount of the purchase price.

### Commencement and Duration of Warranty

The warranty period begins on the date of shipment from Planar. The goods sold hereunder are warranted for a period of eighteen months from date of shipment unless otherwise agreed to by Buyer and Planar. No extension of the warranty will be given during the time the goods are in Planar's possession.

### Place of Repair or Replacement

In order to obtain service under this warranty, Buyer must notify Planar of the defect before expiration of the warranty period, and request a "Return Material Authorization Number." If the configuration has been modified in any manner, the product must be returned to its original configuration before any warranty service will be performed by Planar. No goods are to be returned to Planar without prior authorization. Buyer will be responsible for packaging and shipping the defective goods to the Planar Service Facility located at Beaverton, Oregon, with shipping charges prepaid.

### Limitation of Warranty

The foregoing warranty shall not apply to defects resulting from (a) improper or inadequate maintenance by Buyer; (b) unauthorized modification of the goods; (c) operation of the goods outside of the environmental specifications of the goods; (d) neglect, misuse or abuse of the goods; or (e) modification or integration with other goods not covered by Planar's warranty when such modification or integration increases the likelihood of damage to the goods.

*THE WARRANTY IS GIVEN BY PLANAR IN LIEU OF ANY OTHER WARRANTIES, EXPRESS OR IMPLIED. PLANAR DISCLAIMS ANY IMPLIED WARRANTIES OF MERCHANTABILITY OR FITNESS FOR A PARTICULAR PURPOSE. PLANAR'S RESPONSIBILITY TO REPAIR OR REPLACE DEFECTIVE PRODUCTS IS THE SOLE AND EXCLUSIVE REMEDY PROVIDED TO THE BUYER FOR BREACH OF THIS WARRANTY. PLANAR WILL NOT BE LIABLE FOR ANY INDIRECT, SPECIAL, INCIDENTAL OR CONSEQUENTIAL DAMAGES IRRESPECTIVE OF WHETHER PLANAR HAS ADVANCE NOTICE OF THE POSSIBILITY OF SUCH DAMAGES.*

The warranty set forth above shall not be enlarged, diminished or affected by, and no obligation or liability shall arise from Planar, any authorized dealer or any other person's rendering of technical advice, assistance or services in connection with the buyer's order of the goods furnished hereunder. The Buyer is not relying on Planar's skill or judgment to select or furnish suitable goods.

### **Installation**

Planar makes no warranty with respect to any installation of Planar's product(s) by Planar, any authorized dealer, or any other person.

### **Technical Assistance**

For technical assistance please call +1(503) 690 1100 between 8:00 a.m. and 5:00 p.m. PST, Monday through Friday or email to [app\\_eng@planar.com](mailto:app_eng@planar.com) with a description of your technical issues.

### **Repair Service**

If your Medical Monitor needs service, call Planar Customer Service at +1(503) 690 6960 between 7:00 a.m. and 4:00 p.m. PST, Monday through Friday or fax to +1(503) 748 7085. You will need the unit's serial number and a brief description of the problem to receive a RMA number.

If a repair is required please return the product for service using the original shipping container (if possible) with the RMA number clearly marked on the outside of the box.

In order to protect Planar employees from potential health hazards, Planar requires that the RMA product be **disinfected before returning to Planar for service**. Any product not cleaned prior to shipment **will be returned to the customer**.

---

**Note:** Returns will not be accepted without an assigned RMA number.

---

In-transit damage is not covered by the warranty. We suggest you always insure your shipment. Planar will only pay for the return shipment by surface transportation. It is the responsibility of the sender to prepay transportation charges.

## Ordering Information

<b>Product</b>	<b>Part Number</b>
D6015TM 15-Inch XGA Medical Monitor	996-0431-00
D6015TM 15-Inch XGA Medical Monitor, w/deskstand	996-0432-00
D6015TM;TS 15-Inch XGA Medical Monitor, SAW Touchscreen	996-0435-00
D6015TM;TS 15-Inch XGA Medical Monitor, SAW, w/deskstand	996-0436-00
D6015TM;TR 15-Inch XGA Medical Monitor, Resistive Touchscreen	996-0433-00
D6015TM;TR 15-Inch XGA Medical Monitor, Resistive, w/deskstand	996-0434-00
Planar power adapter, model PPA4512UM	902-0013-00
Planar video cable	903-0167-00
Planar touchscreen cable (optional)	903-0166-00
Planar audio cable	903-0168-00
Planar U.S. hospital-grade power cord	903-0169-00
Backlight replacement (two required per monitor)	996-0421-00
Deskstand	933-0065-00
Universal mounting plate	501-0301-01





---

**North & South America OEM Sales**

Planar Systems, Inc.  
1400 NW Compton Drive  
Beaverton, OR 97006-1992  
Tel. +1(503) 690 1100  
Fax +1(503) 690 1493  
sales@planar.com  
app\_eng@planar.com

---

**Europe & Asia-Pacific OEM Sales**

Planar Systems, Inc.  
Olarinluoma 9, P.O. Box 46  
FIN-02201 Espoo, Finland  
Tel. +358 9 420 01  
Fax +358 9 420 0200  
intlsales@planar.com  
tech\_support@planar.com

---