



INSTRUCTION MANUAL

DSR-3706PA

Digital Video Recorder with Multiplexer Function

About this manual

Before installing and using this unit, please read this manual carefully.
Be sure to keep it handy for later reference.

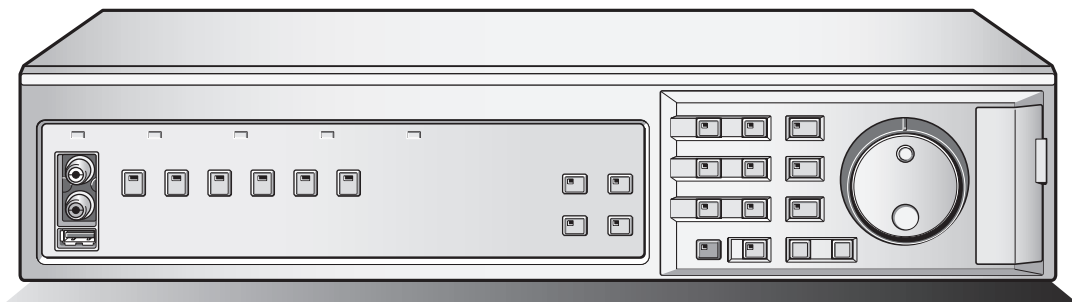

Table of Contents

Foreword	
Safety precautions	3
These must be followed for safety reasons	3
Follow the points outlined below for proper use	5
Main Features	7
Accessories	7
Names and functions of parts (front panel)	8
Names and functions of parts (rear panel)	10
Basic connections	10
Alarm and RS-485 connections	11
Network connection terminals (LAN)	11
Control terminals (CONTROL)	12
How to use	
Preparing for use	13
Turn on the power of the DVR	13
Language, clock settings	13
Operation display	14
Viewing live video using various multi screens	15
Switching to another full-screen video	15
Enlarging an image (Plus screen display)	15
Automatic screen scrolling	16
Viewing on the monitor connected to the MON2 terminal	16
Recording video to the hard disk	17
Recording format verification	17
Normal recording (normal recording area)	17
Viewing recorded video	18
Playback	18
Full-screen viewing	18
Fast-forward/fast-reverse during playback	18
Changing the playback speed	19
Viewing still images	19
Frame advance (forward and reverse)	19
Enlarged viewing	20
Quad-screen viewing	20
Multi-screen viewing	20
Searching for recorded video 21	
A Alarm search	22
B Alarm thumbnail search	22
■ Viewing pre-alarm video	22
C Date/time search	23
■ Viewing the preview screen	23
D Archive area search	24
E Motion detection search	24
■ Motion sensor settings verification using the preview screen	26
■ Full-screen viewing of video detected by the motion sensor	26
Copying recorded video to media 27	
A Copying video (example: 10 seconds) from the normal or alarm recording area to the archive area	28
B Copying video (example: 10 seconds) from the internal hard disk to the CD-R/RW drive	29
C Copying video (example: 10 pictures) from the internal hard disk to media such as a CompactFlash card	30
D Printing images directly from the CompactFlash card or the Microdrive	31
CompactFlash cards or CD-RW formats	32
■ CompactFlash format	32
■ CD-RW format	32
Viewing Images copied to a CompactFlash card and CD-R/RW on a PC	32
How to set	
Main menu configuration	33
Initial settings	34
Menu configuration	34
■ Displaying the initial settings screen	34
■ Changing the menu setting conditions while recording	34
A Summer time setting	35
A-1 External clock setting	35
B Camera detection	35
C Title setting	36
D Holiday setting	36
E Time period setting	37
■ Changing the time period of operations	38
■ Setting the times for the time periods	38
Recording settings	39
Menu configuration	39
■ Displaying the recording settings screen	39
A Easy recording menu description	40
A-1 RECORDING DURATION BASE	41
A-2 REC RATE BASE	42

Table of Contents

E Recording area menu description..... 43	E Network settings69
■ Verifying the capacity of the recording areas. . . . 43	E-1 Network password modification69
E-1 Changing the normal recording area and the alarm recording area 44	F RS-485 settings70
E-2 Archive area full reset 45	Screen settings71
C Recording conditions menu description 46	Menu configuration.....71
■ Remaining hard disk capacity warning. 46	■ Displaying the screen settings.71
C-1 Overwrite setting for the recording areas 47	A Changing the multi-screen sequence72
C-2 Setting series recording 47	E Automatic scrolling of live video of the main monitor and the monitor 2 at identical intervals (example: 5 seconds).....73
C-3 Series recording 48	E-1 Automatic scrolling of live video of the main monitor and the monitor 2 at individual intervals73
C-4 Setting the storage period for videos recorded in the recording areas 48	E-2 Automatic sequence of live video of the main monitor (full-screen) at individual intervals, and of the monitor 2 at identical intervals (example: 3 seconds)74
D Normal recording area menu description..... 49	E-3 Turning off display of specified cameras during timer-controlled periods74
D-1 Normal recording area settings 49	C Masking specific camera images75
E Programmed recording menu description..... 50	D Adjusting color tones of the live video76
E-1 Programmed recording settings..... 50	Power loss information/Used time.....77
F Timer setting menu description 51	A Power loss/Used time menu description77
■ Timer-controlled recording. 51	A-1 Viewing the information77
■ If the timer settings are overlapping. 51	Initialization log78
■ If the Day of the week and Daily settings are overlapping 51	A Initialization log menu description78
■ Cancelling timer-controlled operations. 51	A-1 Viewing the log78
F-1 Day of the week timer-controlled recording (same time, same recording rate every week for the specified day)..... 52	Menu copy79
F-2 Overlapping timer-controlled recording..... 53	A Menu copy screen description79
F-3 External timer-controlled (alarm) recording ... 54	A-1 Save the menu content in the CF card.79
G Alarm recording settings menu description ... 55	A-2 Load menu content saved to the CF card onto other DVRs of the same model.....80
G-1 Alarm recording settings..... 56	Other
G-2 Pre-alarm recording settings 57	Interface (RS-485) specifications81
G-3 Alarm trigger setting 57	Specifications82
■ Input signals used as external alarms 57	List of recording rate and recording times83
G-4 Motion sensor screen description 58	List of record rate setting/ pre-alarm recording times85
G-5 Motion sensor setting 59	Push-lock terminal specifications86
H Alarm operation settings menu description..... 60	
H-1 Alarm operation settings..... 61	
H-2 Alarm display settings..... 61	
■ Alarm cancellation 61	
General settings 62	
Menu configuration 62	
■ Displaying the general settings screen 62	
A Data display settings/VIDEO LOSS settings 63	
B Buzzer settings 64	
C Security lock menu description..... 65	
C-1 Turn ON the ADMIN and USER security locks and set passwords for the DVR 65	
C-2 Activating the security lock..... 66	
C-3 Cancelling the security lock 66	
■ List of permitted operations after setting the passwords 67	
D Hard disk settings menu description 68	
■ Hard disk expansion 68	
D-1 Hard disk initialization 68	

Safety precautions

These must be followed for safety reasons

Warning

■ **Do not use if the unit emits smoke, or while abnormal sounds and smells are detected.**

Using in an abnormal condition may cause electrocution and fires. Immediately remove the power cable from the outlet, confirm that there no smoke is emitting and request repairs at the dealership or factory shop where this unit was purchased.

Do not attempt repairs on your own.



Remove the power cable from the outlet.



■ **Do not use during thunder/thunder storms.**

Do not use during thunder/thunder storms. Never make contact with the connection cable. This may cause electrocution.



Contact prohibited

■ **Do not place in an unstable position.**

This may cause accidents and damage through falling or toppling.

Turn the power off and remove the power cable from the outlet when the unit has been dropped or the cabinet has been damaged. Contact the dealership or factory shop where you purchased this unit.

Using continuously may cause electrocution and fires.



Prohibited



Remove the power cable from the outlet.

■ **Do not disassemble or modify.**

Do not place your hand in the internal areas of this unit as this may cause fires and/or electrocution.

Request for inspections, adjustments, and repairs at the dealership where you purchased this unit or at a factory shop.



Disassembly prohibited.

■ **Do not expose to shock or vibration.**

Stored data may be damaged/lost through hard-disk breakdowns caused by shock/vibration.



Prohibited

■ **Do not expose to water.**

- This unit is not waterproof. Do not expose to water. This may cause fires and/or electrocution.

Do not use in bathrooms.

- Turn the power off and remove the power cable from the outlet if the internal components have been exposed to water. Contact the dealership or factory shop where you purchased this unit. Continuing to use may cause electrocution and fires.



Exposing to water is prohibited.



Using around water is prohibited.

■ **Do not use this unit where it is exposed to the possibility of explosion.**

Do not use this unit in areas where explosive and/or flammable gases are present. This may cause fires and/or explosions.



Prohibited



Please note:

Your SANYO product is designed and manufactured with high quality materials and components which can be recycled and reused. This symbol means that electrical and electronic equipment, at their end-of-life, should be disposed of separately from your household waste.

Please dispose of this equipment at your local community waste collection/recycling centre.

In the European Union there are separate collection systems for used electrical and electronic products.

Please help us to conserve the environment we live in!

This symbol mark and recycle system are applied only to EU countries and not applied to the countries in the other area of the world.

Safety precautions

Caution

■ Delivery and portability

- Never move this unit while the power is turned on.
- Remove the power cable from the outlet, confirm that the connection cable has been removed, and store in original packaging before delivering. Deliver using a method that causes the least amount of shock and/or damage to this unit. Also, do not drop this unit.

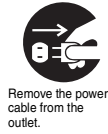

■ Do not expose to extreme temperatures or temperature variations.

- Do not place in areas where the unit will be exposed to extreme temperatures (± 10 degrees Centigrade per hour) or moisture changes.



■ Maintenance when the unit is going to remain unused for long periods

Remove the power cable from the outlet. Carrying out maintenance without removing the power cable may cause electrocution.

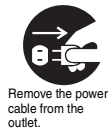

■ Points on unit positioning

This unit is constructed using precision electronic parts. Avoid placing it in areas described below as this may cause faulty operation and/or breakdowns.

- In direct sunlight
- In places exposed to water
- In the vicinity of cooling and heating devices or humidifiers
- Near the air conditioner where the unit is exposed to cool air
- Dusty areas
- Areas that contain fire hazards
- Areas that contain magnetic items
- In the vicinity of volatile substances
- Areas where the unit will be exposed to constant vibration (in trains, cars, etc.)



■ Cleaning the internal components

Consult the dealership or factory shop where you purchased this unit for cleaning internal components. Leaving the unit unused for long periods of time may attract dust to the internal components, which in turn may cause fires and/or breakdowns.



■ Do not block the cooling fans or air ducts.

- This unit is equipped with air ducts and cooling fans in order to assist the ventilation of hot air produced by the hard disk drive.
Placing covers, placing in a case, or placing inside book cases may cause heat build up, and may result in fire and/or electrocution.



When the unit is setup in a rack leave open space on all sides.

- Leave 1 cm or more of space above and below.
- Leave 5 cm or more of space on both sides and on the back side.

■ Cautionary points on condensation

Condensation will result if cold water is poured into a cup. The internal components of this unit are also susceptible to the same condition. This condition is called condensation.

Do not operate when the unit is in a state of condensation.

Operating when the unit is in a state of condensation may cause breakdowns. When exposed to extreme temperature changes, turn the power off and leave the unit for approximately two hours (until the surrounding temperature stabilizes) and then start the unit.

Using this unit while condensation is present may cause breakdowns.

When condensation is likely to result...

Use after turning the power off and leaving for 1~2 hours.

Safety precautions

Follow the points outlined below for proper use

■ Hard disk

This unit is loaded with a **hard disk drive**. Stored data on this unit may be damaged/lost through hard-disk breakdowns caused by shock/vibration.

Follow the items outlined below when placing, transporting, and operating this unit.

Warning

- This unit is designed to be positioned horizontally. Do not position vertically.**
- Do not expose to shock or vibration and do not transport while power is turned on.**
Always turn the power off, even when moving in and out of racks.
- Do not remove the power cable while recording or playing back.**
- Do not move the unit for approximately 30 seconds after turning the power off.**
The hard disk is rotating for a short duration after the power is turned off. The unit is further susceptible to damages through shock and vibration in this state compared to when the power is turned on. Do not move it.
- Do not expose to shock or vibration.**
Avoid placing this unit directly on the floor. Make sure that the four stands attached to the base of this unit are used, when placing it on the floor.
- Always use the original packaging (packaging provided at the time of purchase), when delivering.**
Use the packaging materials provided during the original purchase when the unit or a single internal component is going to be delivered. Deliver using a method that causes the least amount of shock and/or damage to this unit.

Caution

- Inspecting for abnormalities in the hard disk drive and the cooling fan**
This unit is designed to automatically check the drive and cooling fan when the power is turned on. Replacement parts will be necessary if abnormalities are detected. Images will have to be saved and initialization will have to take place if there is a fault with the drive. Consult the dealership where this unit was purchased for details.
 - Wear in the hard disk drive and the cooling fan**
The hard disk drive and cooling fan are consumable items.
Replace the parts stated below when using the unit in a 25°C environment. The replacement timings listed are approximate and do not guarantee the performance or life expectancy of the part in question.
 - Hard disk: 2 years
 - Cooling fan: 3 years
 - Damper: 2 years
- Consult the dealership where the unit was purchased for replacement drives.**
- The drive is vulnerable to static electricity shocks. Take the appropriate measures to prevent exposure to static electricity.
 - Unpackaged drives should be placed horizontally with their base facing upwards on top of a soft cloth. Exposing the drive to shocks and vibration may cause breakdowns.
 - Do not expose the drive to shocks and vibrations while removing/tightening the screws during replacement. Firmly tighten the screws after replacement.

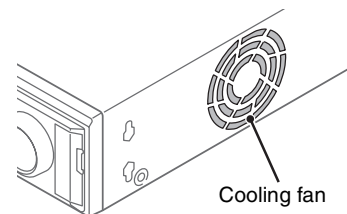

Safety precautions

■ Back up battery

- A lithium battery (fixed) is built into this unit. Supplying power for more than 48 hours after setting the date and time will allow the internal power source to sustain the set time for 30 days.
- The battery is expected to last for approximately 5 years if the unit is used regularly.
- Battery fluid leaks

Rinse hands/clothes thoroughly with water in case battery fluid has leaked.

Loss of eyesight may result if battery fluid enters the eyes. Do not rub. Immediately rinse with clean water and consult a physician.

The following symptoms will result if the battery is leaking or has reached the end of its life expectancy. Consult the dealership where this unit was purchased or the nearest repair center for replacements.

- **The clock is automatically reset once the power source is cut.**
- **Does not return to automatic standby.**
- **The image number is not recorded.**

When disposing of this unit

Consult the dealership where the unit was purchased for the disposal process of the lithium battery.

■ If unused for a lengthy period of time

Remove the power cable from the outlet. Remember to occasionally turn the power on in order to maintain correct function.

■ Pre-confirm important recording assignments.

Recording and/or playing back functions may be unavailable due to hard-drive or connecting device failures. Always confirm that recording can be carried out successfully before carrying out important recording assignments. The recorded content cannot be guaranteed.

It is recommended that periodic back ups or mirroring is conducted in order to prevent breakdowns or recording faults through accidents.

■ Maintaining this unit

Turn the power off and remove the power cable from the outlet.

Wipe away dust using a soft cloth.

When the stains are hard to remove...

Soak the cloth in water with diluted neutral detergent.

Wipe the stain and moisture away with a dry cloth.

Note:

- Do not use paint thinner, benzene, or any other alcohol based agents for cleaning. The exterior may deteriorate or the paint may wear off.
- Follow the instructions provided on the packaging of the chemical cleaning agent.
- Do not spray volatile substances, such as insecticides, etc. onto the unit.
- Also, avoid direct contact of rubber or vinyl products with the unit.
This may cause the exterior to deteriorate or the paint to wear off.

■ Copyright information

- This manual and software are copyrighted by Sanyo Electric Co., Ltd.
- Brand and product names used in this manual are the trademarks or registered trademarks of their respective companies.

Except for personal use, copyright law prohibits the use of recorded copyrighted images without the permission of the copyright holder.

Main Features

■ **This digital video recorder (DVR) can record video from surveillance cameras to its internal hard disk, and it can display the video on a screen split into six or four fields, both during recording, and playback.**

■ **Complete range of recording and playback functions**

- Simultaneous recording and playback.
- Timer-controlled recording allows for different recording schedules for each day of the week.
- Zoom function allows for enlarging images during surveillance and playback.
- Alarm recording allows for recording the actions of intruders.
- Masking function allows for masking the video from specific cameras using a gray pattern, preventing it from being monitored.
- Motion sensing can be used with each camera and alarm operation can be used to give priority to the recording of moving subjects.

■ **Search function allows for instant display of the desired recording (P21)**

- Alarm search based on the order of alarm occurrences
- Alarm search based on alarm thumbnails
- Date and time search based on the time and date of the recording
- Archive area search
- Motion detection search based on intruder motion

■ **Two-level security lock allows for restricting the users and manage data and equipment (P65)**

■ **Expandable, can be connected to a computer**

- Recorded video can be copied to CompactFlash cards or CD-R/RW.
- A built-in LAN terminal provides support for network control, thus facilitating live surveillance, playback, search and menu setting.
- Surveillance can be carried out on two different monitors, namely the main monitor, and monitor 2. The main monitor can be used for split-screen viewing, while the monitor 2 can be used for full-screen viewing or for automatic screen scrolling.
- Images stored on CompactFlash cards and Microdrive can be directly printed on a printer.

Accessories

Check that you have all the parts shown below.

- **Quick Guide**
- **Instruction Manual (Digital Video Recorder)**
- **Manual for Remote Operation using a Network Connection**
- **Mounting screws for hard disk x8**
- **Power cable/Cord tie**

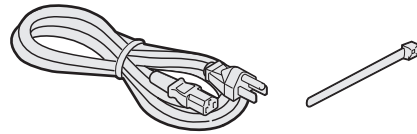

Names and functions of parts (front panel)

DSR-3706PA

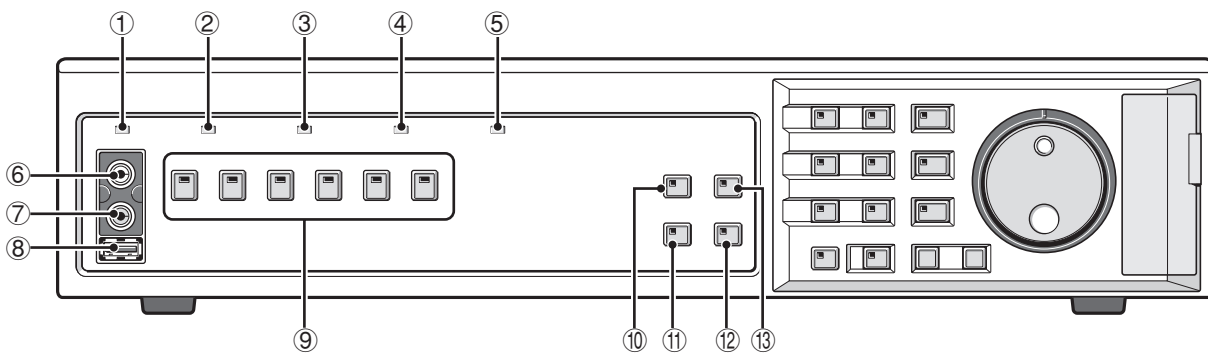

① Power indicator (POWER)

- On:** The power cord at the rear panel of the DVR is inserted in the outlet.
- Off:** The power cord on the rear panel of the DVR is not inserted in the outlet.
- Fast blinking:** Hard disk error.
- Slow blinking:** Cooling fan error.
- If the indicator is blinking, contact the store where you purchased the DVR.

② Remaining capacity warning indicator (FULL) (P46) (Normal recording area)

- On:** When recording on the hard disk has become impossible.
- Blinking:** The available hard disk space has dropped below the specified level.
- Off:** The available disk space is reset by initialization or by allowing overwrite.

③ Remaining alarm capacity warning indicator (ALARM FULL) (P46) (Alarm recording area)

- On:** When recording on the hard disk has become impossible.
- Blinking:** The available hard disk space has dropped below the specified level.
- Off:** The available disk space is reset by initialization or by allowing overwrite.

④ Lock indicator (LOCK) (P66) (Security lock)

- On:** The operation has been locked using the security lock.
- Off:** The password of a valid administrator is entered to release the lock (a buzzer will sound).

⑤ Alarm indicator (ALARM)

- On:** Pre-alarm recording.
- Blinking:** Alarm recording.

⑥ Audio output terminal (AUDIO OUT)

The audio output is the same as that of the rear panel AUDIO OUT terminal.

⑦ Video output terminal (VIDEO OUT)

The video output is the same as that of the rear panel MAIN MONITOR OUT terminal.

⑧ USB terminal (USB)

This terminal connects to an optional CD-R/RW drive. When the front panel and the rear panel terminals are connected simultaneously, the front panel is given priority.

⑨ Camera selection buttons and indicators

On: The camera is selected, or in multi-screen mode, the indicator is on for each selected camera.

Blinking: Video-loss or an alarm detected.

When "K" is displayed in the upper right corner of the screen a value can be input. (P33)

⑩ Quad-screen display button and indicator (QUAD) (P20)

On: Quad-screen display.

Off: Other operation is selected.

⑪ Monitor 2 button and indicator (MON 2) (P16)

On: Monitor 2 operation.

Off: Other operation is selected.

⑫ Plus screen button and indicator (PLUS) (P15)

On: Enlarges and displays the image of one camera only in the top left corner of the screen.

Off: Pressing the PLUS button again will display the previous screen.

⑬ Multi-screen button and indicator (MULTI) (P20)

On: Multi-6 screen display.

Off: Other operation is selected.

Names and functions of parts (front panel)

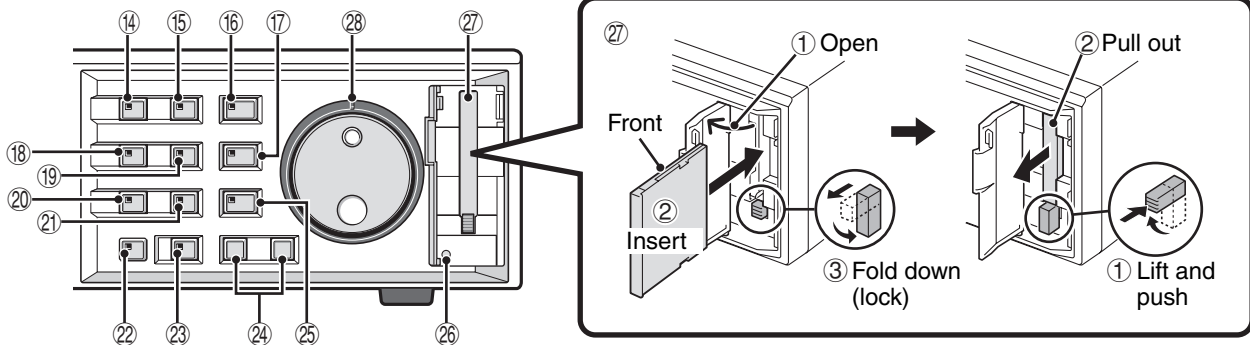

⑭ **Menu button and indicator (MENU)**

On: The menu is displayed.
Off: The EXIT/OSD button is pressed.

⑮ **Exit/Operation screen display button and indicator (EXIT/OSD)**

On: Displaying the channel and operations information when switching from the menu screen, etc. to the live image or the playback screen.
Off: The main or other menu is displayed. The channel or operational information is hidden.

⑯ **Playback/Stop button and indicator (▶ PLAY/STOP)**

On: Playback of video recorded on the hard disk.
Off: The playback is stopped.

⑰ **Pause button and indicator (|| STILL)**

On: Still image display.
Off: Still image display cancelled.

⑱ **Zoom button and indicator (ZOOM)**

On: Digital zoom operation.
Off: The digital zoom operation is cancelled.

⑲ **Search button and indicator (SEARCH)**

On: Search for a recorded image.
Off: Exiting the search screen.

⑳ **Automatic camera scrolling button and indicator (SEQUENCE)**

Blinking: Automatic scrolling of live video.
Off: Automatic scrolling cancelled.

㉑ **Copy button and indicator (COPY)**

On: When currently copying video from the hard disk to the archive area or other recording media.
Off: When copying operation is over and cancelled.

㉒ **Record/Stop button and indicator (● REC/STOP)**

On: Normal recording (if pressed longer than 3 seconds, the REC/STOP indicator turns off).
Off: Recording is over.

㉓ **Timer-controlled recording button and indicator (TIMER)**

On: Timer-controlled recording or standby.
Off: When pressed again (cancel)

㉔ **Alarm buttons (◀◀ ALARM ▶▶)**

When an ALARM button is pressed during playback or still, the digital video recorder skips to the next earlier or next later alarm.

㉕ **Shuttle hold button and indicator (SHUTTLE HOLD)**

On: The rotation angle of the shuttle dial is locked.
Off: When pressed again (cancel)

㉖ **Menu reset button (MENU RESET)**

If the button is pressed after menu-setting, the items displayed on the screen will be reset to their default values.

㉗ **CompactFlash card slot**

Verify the correct orientation of the CompactFlash card or Microdrive before inserting it into the slot.

㉘ **Operating dials (SHUTTLE/JOG)**

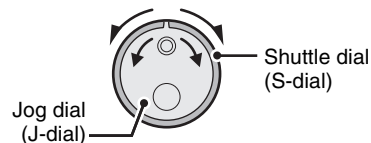

During playback:

- The jog dial changes the playback speed.
- The shuttle dial fast-forwards or fast-reverses playback.

During menu display:

- The jog dial moves the cursor and changes settings.
- The shuttle dial confirms settings.

Names and functions of parts (rear panel)

Basic connections

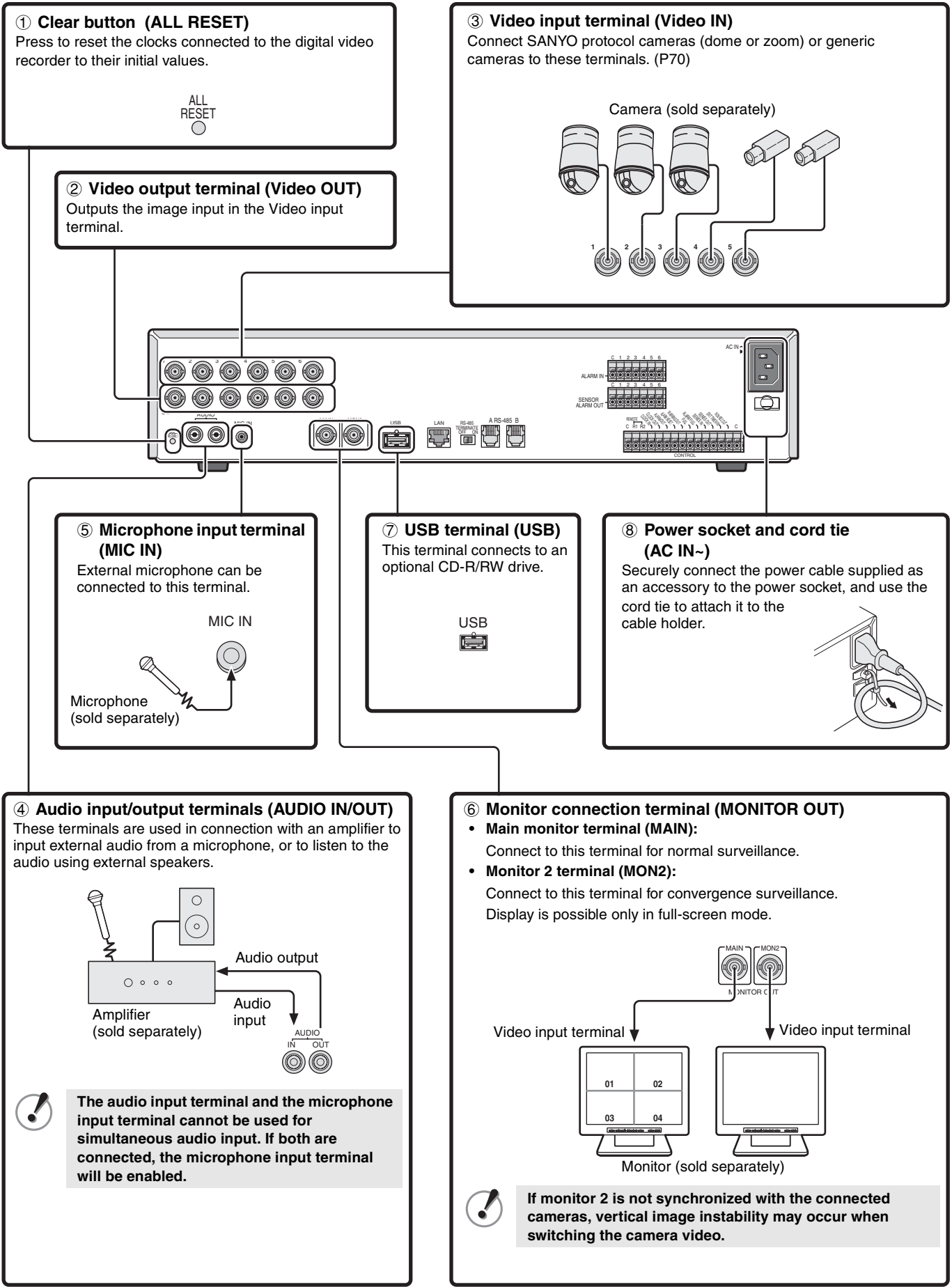

Names and functions of parts (rear panel)

Alarm and RS-485 connections

① Alarm input terminals (ALARM IN)

Connecting a switch or security sensor etc. to the terminal of the DVR allows the detection of the intrusion of outsiders when doors etc. are opened and closed.
Alarm input settings are necessary. (P55)

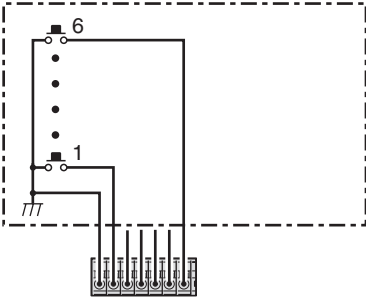

External switch connected to the alarm input terminal



② Sensor alarm output terminals (SENSOR ALARM OUT)

This terminal is used to output the signals listed below whenever the motion sensor of the digital video recorder is triggered. This output terminal can be used for a warning light by connecting a lamp to it.
Motion sensor settings are necessary. (P58)

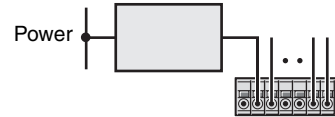

Rating for each terminal:
 • Maximum current: 25mA
 • Maximum voltage: DC 25V

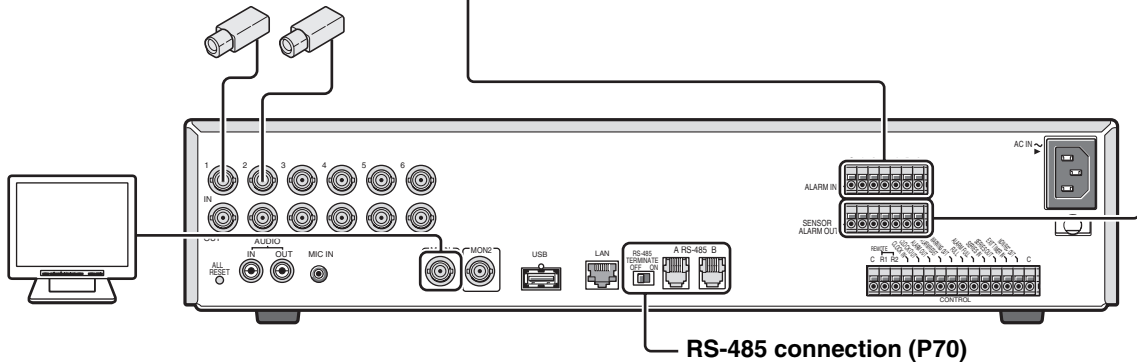

Network connection terminals (LAN)

Use Category 5 10BASE-T/100BASE-TX LAN cables.

A Connecting directly to a PC (without using a hub)

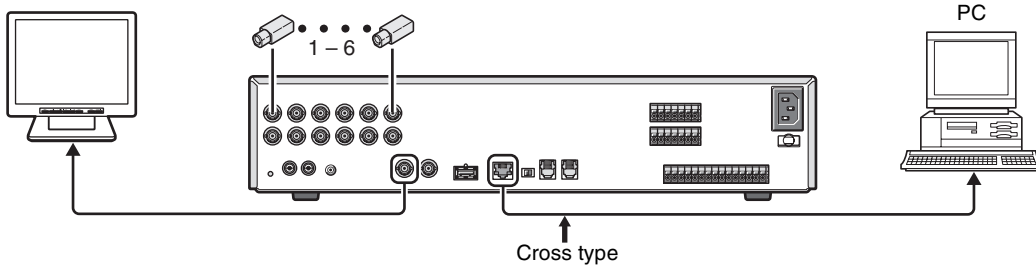

B Connecting to the intranet (using a hub)

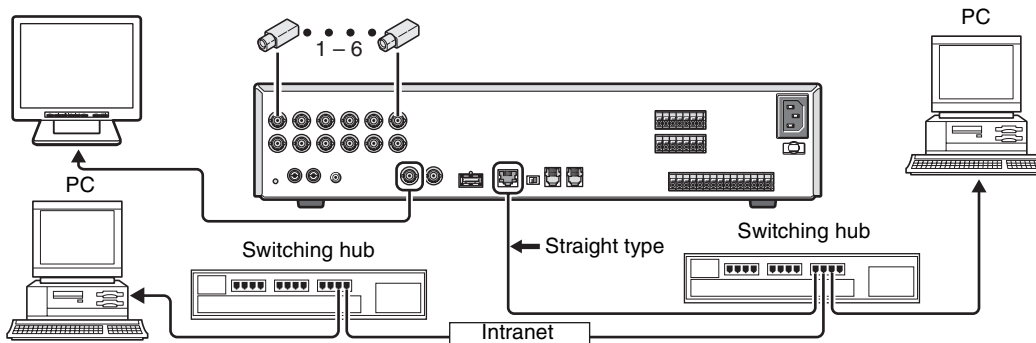

Names and functions of parts (rear panel)

Control terminals (CONTROL)

This DVR can be remotely controlled when a remote-control circuit (R1, R2, C) similar to that shown below is connected to the remote-control terminals.

- Use a resistance of 1/10 ohms or more and with a D ranking (Precision within ±0.5%).
- The remote control cable should be no more than 5 m long.

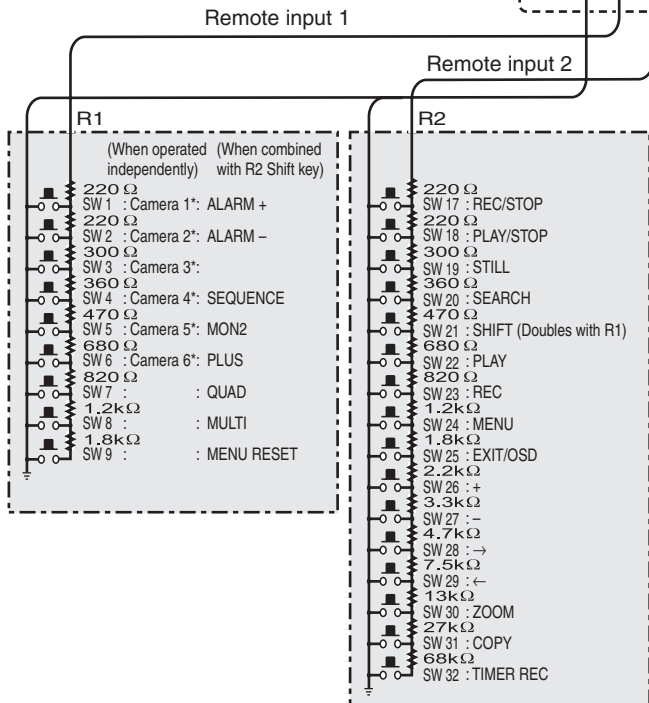
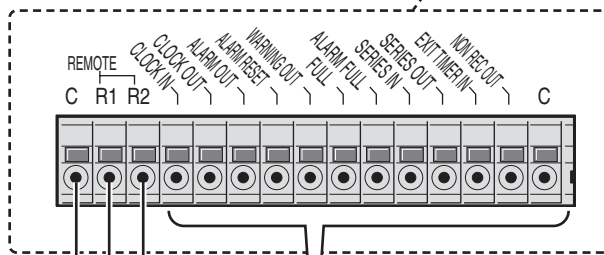
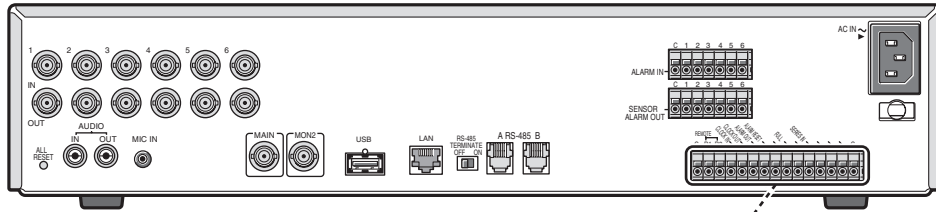

Pin	Signal
CLOCK IN	Input of a clock setting signal from an external device
CLOCK OUT	Output of a clock setting signal to an external device
ALARM OUT	Total alarm output
ALARM RESET	Alarm reset input
WARNING OUT	Output of an HDD malfunction error
FULL	Capacity warning output for normal recording area space
ALARM FULL	Capacity warning output for alarm recording area space
SERIES IN	Signal input from an analog series connection
SERIES OUT	Signal output to an analog series connection
EXT TIMER IN	Signal input from an external timer
NON REC OUT	Recording stopped output
C	Ground

Preparing for use

Turn on the power of the DVR

1 Connect the supplied power cable.

The power indicator turns on, and the monitor displays the "PLEASE SET THE CLOCK !" message.

The DVR performs playbacks or searches based on the recording date and time. Select the LANGUAGE/CLOCK SET using the INITIAL SET in the MAIN MENU, and set the date and time using <CLOCK SET>.

- At the same time, the recording areas of the internal hard disk are setup automatically. When the REC/STOP button is pressed, the device is ready for recording.

Please refer to the "Recording area menu description" section for more information. (P43)

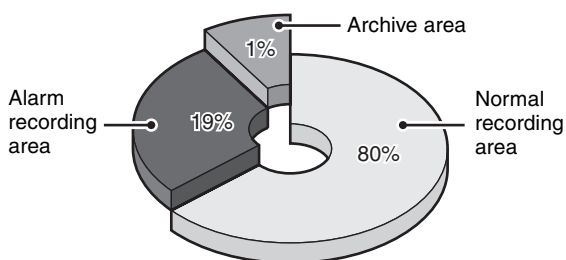

(Hard disk recording areas)



If the alarm indicator blinks when the power is turned on or when settings are performed, this indicates that the hard disk or the cooling fan is malfunctioning. Refer to P5 and P8 for more information.

- Fast blinking: Hard disk error
- Slow blinking: Cooling fan error

2 When the time and date setting is complete, the operation display appears on the monitor.

The operation display shows operation/related information, such as the date, time and the operation symbol.

Refer to "Operation display" for more information. (P14)

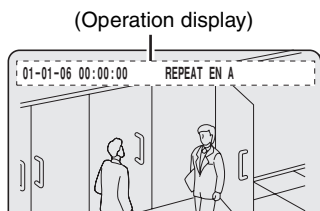

Language, clock settings

1 Press the MENU button and turn the S-dial clockwise 3 times.

"ENGLISH" starts blinking.

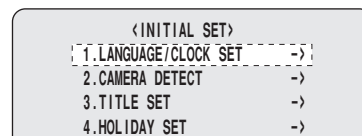
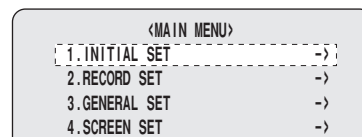
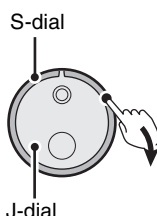
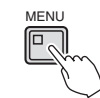

2 Turn the J-dial to select the language from the languages displayed on the screen, and then turn the S-dial.

The cursor moves to the date/time settings.

Language selection:

ENGLISH, FRANCAIS, DEUTSCH, ESPAÑOL

3 Turn the S-dial to set the date/time.

Example: October 26, 2006 8:30am

Select the number using the J-dial, and then turn the S-dial clockwise to set it. Repeat the procedure for the entire setting.

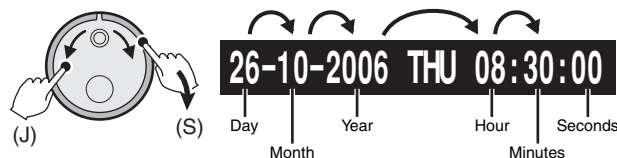

When the setting of "Minutes" is complete, the cursor moves to <SUMMER TIME SET>, and the clock starts from 00 seconds.

- The day of the week is automatically set.
- The clock is stopped during date/time settings.

4 Press the EXIT/OSD button to end the setting procedure.



Preparing for use

Operation display

The operation display shows information necessary for operation, such as the date, time and video quality. The operation display can be hidden.

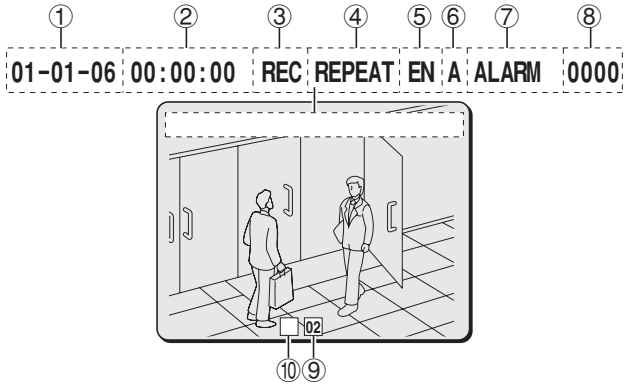

Changing the position of the operation display

Whenever the EXIT/OSD button is pressed, the position of the operation display changes.

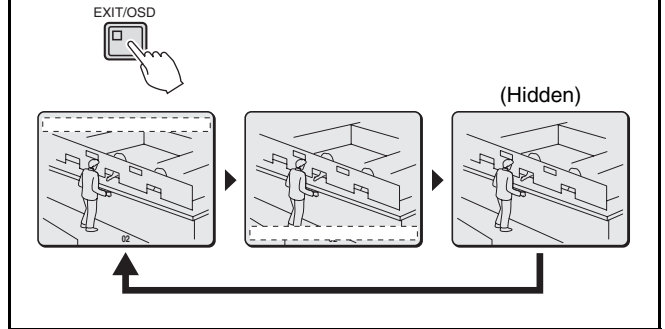

① Date display

01-01-06 (day, month, year): Do not forget to set the date using the menu settings when turning the power on for the first time.

② Time display

00:00:00: Do not forget to set the time using the menu settings when turning the power on for the first time.

③ Operation symbols

The operation symbols are displayed during recording and control operations.

- | | |
|--|-----------------------------|
| REC: Recording | ▶▶ : Fast-forward playback |
| EXT: External timer recording | ◀◀ : Fast-reverse playback |
| ◀ : Reverse playback | ▶ : Slow playback |
| : Still | ◀ : Reverse slow playback |
| ▶ : Playback (including simultaneous recording and playback) | |

④ Remaining recording area (P46)

It is displayed only during normal and alarm recording.
1% ~ 100%:

If overwrite is not permitted on the hard disk, it displays the remaining area as a percentage.

REPEAT:

Repeatedly overwrites the video on the hard disk.

⑤ Image quality display

The image quality display indicates the quality of the video recorded on the hard disk.

- BA** (Basic): Rough image quality, approx. 15kB
- NO** (Normal): Standard image quality, approx. 22kB
- EN** (Enhanced): Enhanced image quality, approx. 30kB
- FI** (Fine): Fine image quality, approx. 42kB
- SF** (Super Fine): Super fine image quality, approx. 50kB

⑥ Audio recording indicator

(P49: ② **AUDIO RECORDING**)

Displayed when audio recording is performed.

⑦ Recording type

- **ALARM:** Alarm playback or standby is in progress
- **ALARM (Blinking):** Alarm recording is in progress
- **PRE:** Pre-alarm playback or standby is in progress
- **ARCHIV:** Archive playback is in progress

⑧ Alarm total

The alarm total indicates the total number of alarms.

⑨ Camera title

• 01-06:

First it displays the camera number. The camera number can be replaced with a name such as the camera's location.

• VIDEO LOSS:

The display alternates between this message and the camera number when the camera video is lost.

When the operations display of the monitor is hidden the message blinks in the same position.

• NO VIDEO:

It is displayed in place of the camera number if there is no video signal connected to the video input terminal.

⑩ Alarm type

- **EA:** The display alternates between this message and the camera title when an external alarm signal is detected.
- **SA:** The display alternates between this message and the camera title when a motion sensor alarm signal is detected.
- **ES:** The display alternates between this message and the camera title when an external alarm signal and a motion sensor signal are detected.

Viewing live video using various multi screens

Switching to another full-screen video

Press the camera selection button (example 2, 6) of the desired camera.

The video from Camera 2, then the video from Camera 6 are displayed.

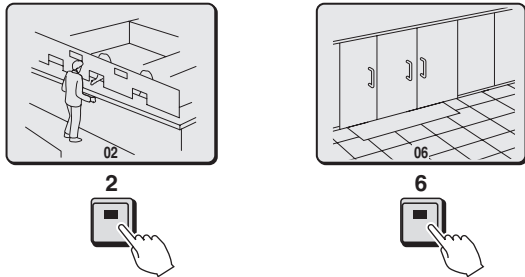

Refer to P20 for enlarging the images (zoom).

Enlarging an image (Plus screen display)

- 1 Press the PLUS button.**
One camera image is displayed enlarged.

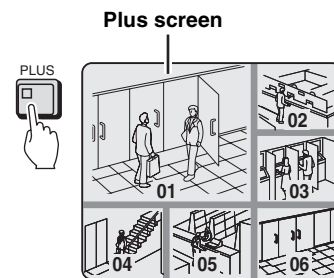

- 2 Press the camera selection button (example 6).**
The corresponding image is enlarged.

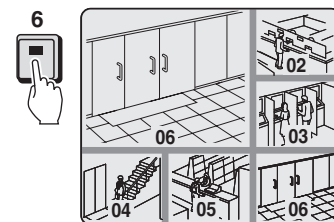

Concerning the operation of the plus screen

- Pressing the PLUS button while playing the video on the plus screen display, displays the image played on the plus screen while displaying the live images on the other screens.
- Pressing the SEQUENCE button while using the plus screen display sets the plus screen to automatic switching.

Viewing live video using various multi screens

Automatic screen scrolling

A Automatic full-screen scrolling

Press the **SEQUENCE** button.

The live surveillance video scrolls through the cameras in the order of the camera numbers.

To stop the automatic scrolling, press the **SEQUENCE** button once again.

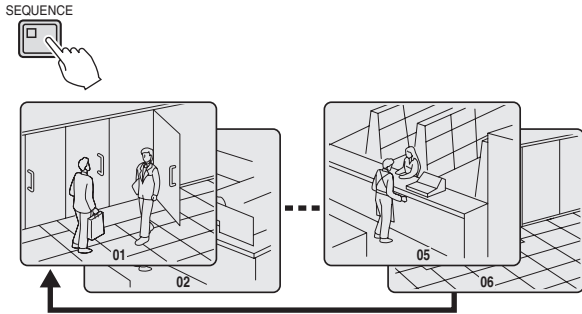

Refer to P73 for information about setting the automatic scrolling interval for the cameras.

B Automatic quad-screen scrolling

1 Press the **QUAD** button.

The live video is displayed in quad-screen mode.



2 Press the **SEQUENCE** button.

The monitor display switches to quad-screen mode.

To stop the automatic scrolling, press the **SEQUENCE** button once again.

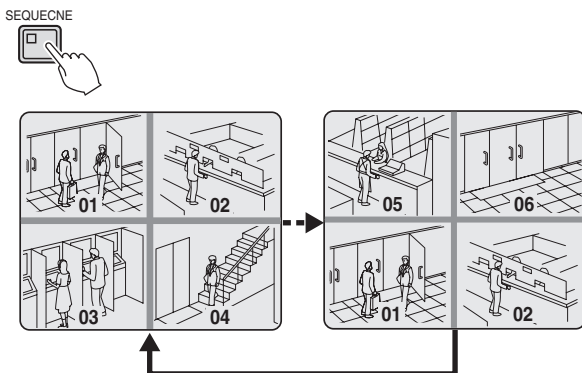

Viewing on the monitor connected to the MON2 terminal

Connect a monitor to the MON2 terminal on the rear panel. The display is full-screen only. (P10)

While the main monitor is used in split-screen mode, the monitor 2 connected to the MON2 terminal can be used to view full-screen video from a single camera or to automatically scroll through video from all cameras.

1 Press the **MON2** button, and then the camera selection button (example 4).

The image from Channel 4 (04) is displayed on Monitor 2.

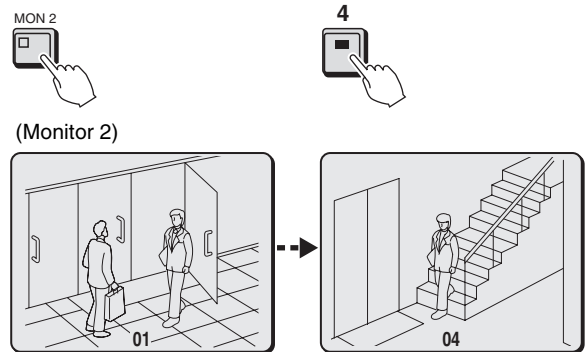

2 Press the **SEQUENCE** button.

Monitor 2 switches to full-screen automatic scrolling.

To stop the automatic scrolling, press the **SEQUENCE** button once again.

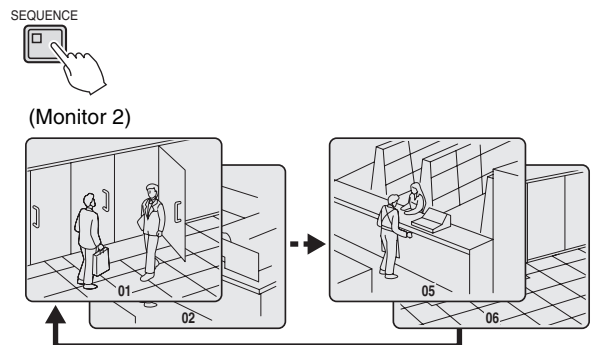

Press the **MON2** button to stop surveillance on Monitor 2.



- The **MON2** button cannot be used during menu display.
- Recorded video cannot be viewed on the monitor connected to **MON2** terminal.

When an alarm is detected, the corresponding live video can be viewed on Monitor 2. See P60.

Recording video to the hard disk

The internal hard disk is automatically formatted with recording area, normal recording, recording conditions, etc. Before starting recording, verify the recordable duration for normal recording (List of recording rate and recording times: P83). The formatting can be modified using "Recording settings". (P39)

Recording format verification

A The total capacity of the hard disk and each area can be verified. (P43)

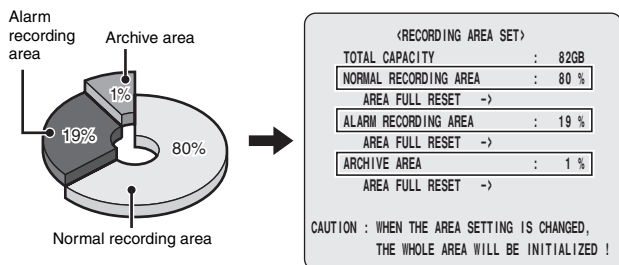

B The settings for recording image quality (ENHANCED), audio recording, recording rate, and programmed recording can be verified. (P49)



C Overwrite setting for each recording area can be verified. If overwrite is set, and the recording area is full, the oldest video is overwritten by new in the order of recording. The default setting is ON, which enables overwrite, thus provides for continuous recording. (P46)

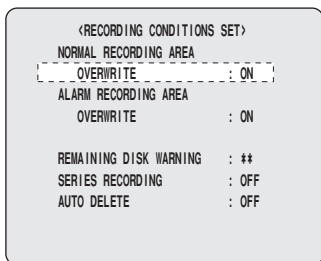

Normal recording (normal recording area)

Video from all cameras connected to the video input terminals of the DVR can be recorded with one touch of a button.

1 Press the REC/STOP button while a live image is displayed.

"REC" appears on the operation display, and recording starts.

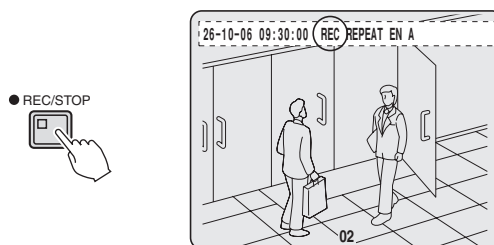

2 Press the REC/STOP button for approximately 3 seconds to stop recording.

The "REC" display disappears.

- Press the **PLAY/STOP** button to start playback. (P18)
- Playback is possible during recording. (P18)

Other recordings

In addition to normal recording, the following types of recordings can be used. These methods require some settings and installation. Refer to the appropriate pages.

Timer-controlled recording (records to the normal recording area) P51

Automatically records the video within the preset timeframe.

Alarm recording (records to the alarm recording area) P55

Automatically records when an alarm is input from the external alarm switch or the motion sensor.

Pre-alarm recording (records to the alarm recording area) P57

Records video and audio directly before the alarm input. This information can be used for analyzing the circumstances of the alarm occurrence.

Regarding network downloads

When downloading image data of the DVR via the network, an archive capacity area of approximately 2GB is necessary for best quality images. (40,000 images without audio)

Viewing recorded video

(Normal recording area)

This DVR can play video that has already been recorded or currently being recorded in the normal recording area (by normal or timer-controlled recording).

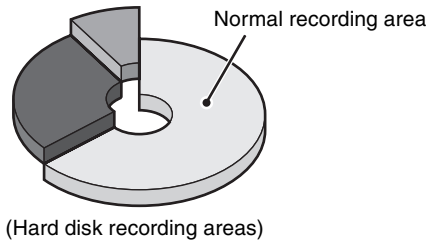

Playback

- If the start point of the recording becomes unknown due to deleting video or resetting, then video playback will start from the earliest recording.
- Once the video is played back the DVR will remember the point up to which the video was played. Therefore, if the playback is stopped it will start again from that point.

Playback is possible during recording.

If the **PLAY/STOP** button is pressed during recording, the video playback will begin from the start point of recording. When playing video near the point of recording, video playback may pause temporarily.



Full-screen viewing

- 1 Press the PLAY/STOP button.**
The "▶" symbol appears in the operation display area and the video starts playing.

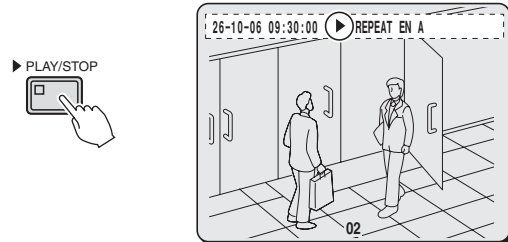

- When playback ends, the DVR pauses automatically, and the STILL indicator turns on. The "||" symbol appears in the operation display area.

- 2 Press the camera selection button (example 3, 6) to play the recorded video of the desired camera.**

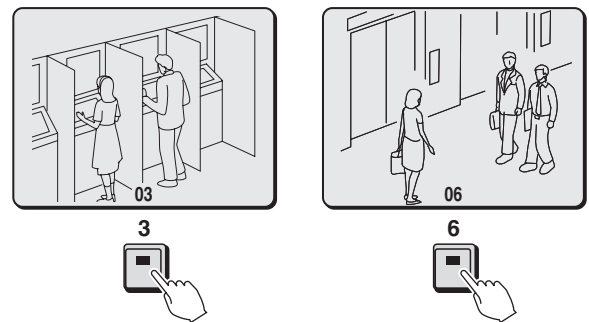

- 3 Press the PLAY/STOP button to end the playback.**

Fast-forward/fast-reverse during playback

Turn the S-dial clockwise for fast-forward.
The "▶▶" symbol appears in the operation display area.



Turn the S-dial counterclockwise for fast-reverse.
The "◀◀" symbol appears in the operation display area.



Release the S-dial for normal playback.

Maintaining the speed of fast-forward or fast-reverse
Press the **SHUTTLE HOLD** button while turning the S-dial for fast-forward or fast-reverse.

The speed will be maintained even after the S-dial is released.



Viewing recorded video

Changing the playback speed

The corresponding symbol (▶, ▶▶ ...) appears in the operation display area for each of these operations. Audio will not be played when changing the playback speed.

A Fast-forward/Slow playback

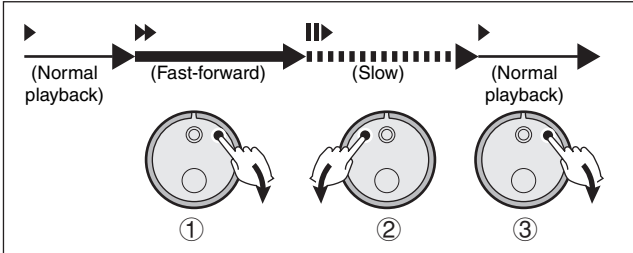

- ① Turn the J-dial clockwise. Fast-forward playback starts.
- ② Turn the J-dial counterclockwise. Slow playback starts.
- ③ Turn the J-dial clockwise. Normal playback starts.

B Fast-reverse/Slow-reverse playback

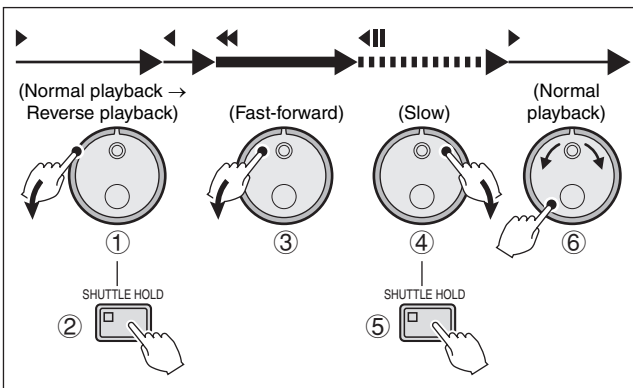

- ① Turn the S-dial counterclockwise. Normal reverse playback starts.
- ② Press the SHUTTLE HOLD button. Reverse playback speed is locked.
- ③ Turn the J-dial counterclockwise. Fast-reverse playback starts.
- ④ Turn the J-dial clockwise. Slow-reverse playback starts.
- ⑤ Press the SHUTTLE HOLD button. Shuttle lock is released.
- ⑥ Turn the J-dial clockwise or counterclockwise. Normal playback starts.

Viewing still images

Press the STILL button during playback.

The image is paused. The "||" symbol appears in the operation display area.

Press the STILL button once again, to return to normal playback.

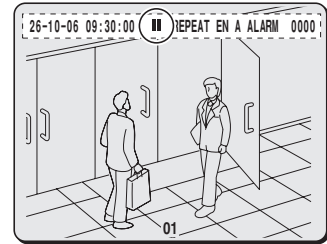

Frame advance (forward and reverse)

Use this function while playback is paused.

- Turn the J-dial clockwise. The still image moves forward by one frame (one field).

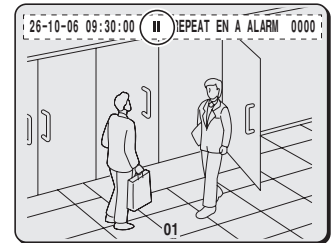

- Turn the J-dial counterclockwise. The still image moves back by one frame (one field).

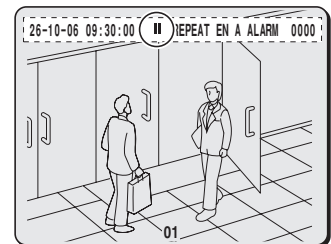
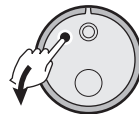

When the video from the normal recording area and the alarm recording area are played back in succession, or video is played back during alarm recording, the following conditions may occur.

- The quality of the images of the video may deteriorate when playback switches between recording areas.
- The image may appear paused during normal playback or fast-forward/fast-reverse.

Viewing recorded video

Enlarged viewing

The zoom function is not available in multi-screen, plus screen mode or on the monitor connected to MON2 terminal.

- 1 Press the ZOOM button.**
A zoom frame appears in the center of the screen. Live video can be magnified during surveillance. Images become coarser during zooming.

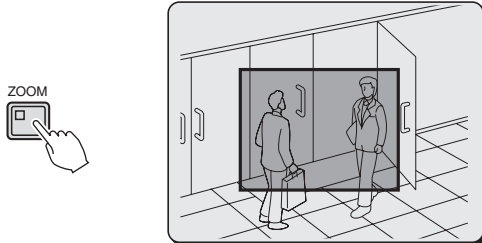

- 2 Move the zoom frame to the area to be enlarged.**
 - ① Turn the J-dial to move the frame horizontally.



- ② Turn the S-dial clockwise, and then turn the J-dial to move the frame vertically.**

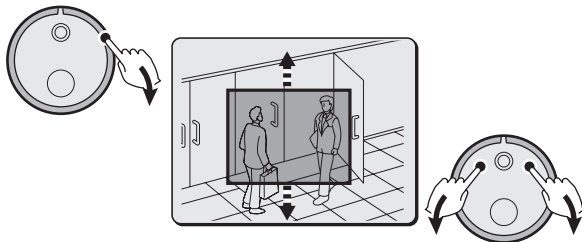

- 3 Turn the S-dial clockwise.**
The area enclosed by the zoom frame is enlarged by a factor of 2.

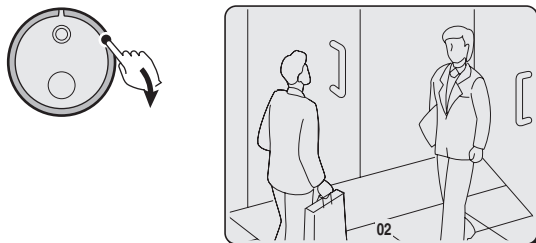

- 4 Press the ZOOM button to cancel the zoom function.**

Quad-screen viewing

If video is recorded from a number of cameras, the recorded videos can be played back in a quad-screen format.

- 1 Press the QUAD button during playback.**
Videos recorded from camera numbers 1~4 are displayed in quad-screen format.
- 2 Press the QUAD button repeatedly.**
The monitor display switches quad screen at the time. Press the camera selection button to return to full-screen display.

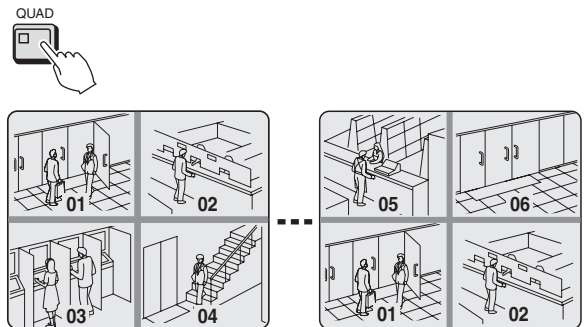

Multi-screen viewing

If video is recorded from a number of cameras, the recorded videos can be played back in a multi-screen format.

- Press the MULTI button during playback.**
Videos recorded from camera numbers 1~6 are displayed in multi-6 format.
Press the camera selection button to return to full-screen display.

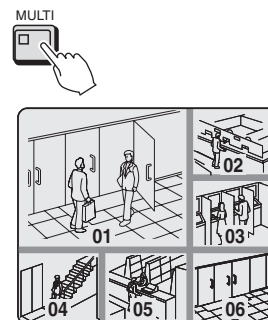

☞ Refer to P72 for information about rearranging the position of the screens.

Searching for recorded video

Video stored in the normal recording area, alarm recording area or archive area can be located by searching and then played back.

Use one of the five search methods to locate the required video.

Press the SEARCH button:



The <SEARCH> screen appears.



Searching is not possible during playback and menu display.

Note: During playback of video, the S-dial, the J-dial and the front panel buttons can be used for operations such as pause and fast-forward.

<SEARCH>

ALARM SEARCH ->

ALARM THUMBNAIL SEARCH ->

TIME/DATE SEARCH ->

ARCHIVE AREA SEARCH ->

MOTION DETECTION SEARCH ->

MOVE: JOG SELECT: SHUTTLE

J (jog) dial S (shuttle) dial

A Alarm search (P22)

<ALARM SEARCH>

NO	DATE	TIME	CH	TOTAL ALARMS
0016	05-01	09:53	1	00016
0015	05-01	09:53	1	
0014	05-01	09:53	1	
0013	05-01	09:53	1	
0012	05-01	09:52	1	
0011	05-01	09:51	1	
0010	05-01	09:51	1	
0009	05-01	03:10	1	

MOVE: JOG SELECT: SHUTTLE

Searches and plays alarm video from the recording list based on date and time.

Searches and plays all video stored in the alarm recording area. If pre-alarm video was also recorded, then the video immediately before the alarm can be viewed, too.

B Alarm thumbnail search (P22)

Searches and plays alarm video from the thumbnail list based on alarm number.

The videos recorded in the alarm recording area are displayed in the thumbnail list.

C Date/time search (P23)

<TIME/DATE SEARCH>

RECORDING TOP : 16-01-06 14:46

RECORDING END : 19-01-06 13:32

CHANNEL : --

SEARCH :

DATE	TIME
16-01-06	14:46
PREVIEW	->
VIEW	->

CHANGE: JOG SET: SHUTTLE

Searches the recorded video period based on date and time.

Video stored in the normal recording area (by normal recording or timer-controlled recording) and in the alarm recording area can be played back by specifying the date and time.

D Archive area search (P24)

<ARCHIVE AREA SEARCH>

NO	DATE	START	CH	CAPACITY
0001	01-01	01:48	1	TOTAL - 816MB
0002	05-01	09:53	1	USED - 16MB
0003	01-01	02:41	1	
0004	02-01	03:10	1	
0005	02-01	04:25	1	
0006	04-01	02:40	1	
0007	04-01	01:25	1	
0008	04-01	01:25	1	

MOVE: JOG SELECT: SHUTTLE

Searches and plays back video stored in the archive recording area based on date and time.

E Motion detection search (P24)

<MOTION DETECTION SEARCH 1>

SEARCH FROM : ALARM

START : 01-01-06 00:40

END : 05-01-06 10:17

CHANNEL : --

START PREVIEW ->

MOVE: JOG SELECT: SHUTTLE

<MOTION DETECTION SEARCH 2>

SEARCH FROM : ALARM / CHANNEL : 4

START : 05-01-06 10:00

END : 05-01-06 10:17

MOTION SENSOR ->

PREVIEW ->

VIEW ->

MOVE: JOG SELECT: SHUTTLE

Retrieves and plays the images that were detected by the motion sensor and recorded on the specified area, channel or at the specified time.

Searching for recorded video

A Alarm search

1 Press the **SEARCH** button during recording or live video.

2 Turn the **J-dial**, select "**ALARM SEARCH**", and turn the **S-dial** clockwise.

The <ALARM SEARCH> screen is displayed.

The eight most recent alarm recordings are displayed.

Press the **SEARCH** button to cancel the search mode.

Operation returns to the normal screen.

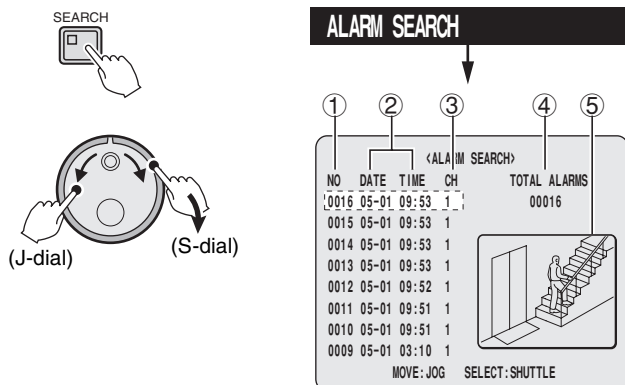

(Menu item - Description)

- 1 NO:**
Displays the alarm number.
- 2 DATE/TIME:**
Displays the date and time at which the alarm video was recorded.
- 3 CH:**
Displays the channel (camera number) of the alarm video.
- 4 TOTAL ALARMS:**
Displays the total number of alarm videos recorded.
- 5 Preview screen:**
Displays the selected alarm video.

3 Turn the **J-dial** to move the cursor to the "**NO**" you want to play and then turn the **S-dial** clockwise.

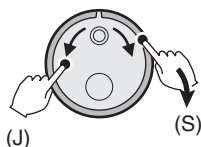

First, the preview screen displays the video recorded at the moment of the alarm occurrence, and then the selected video is played in full-screen mode. When the selected video is over, playback pauses.

4 Press the **PLAY/STOP** button.



B Alarm thumbnail search

1 Press the **SEARCH** button during recording or live video.

2 Turn the **J-dial**, select "**ALARM THUMBNAIL SEARCH**", and turn the **S-dial** clockwise.

The nine most recent alarm videos are displayed.

An alarm number is displayed for each alarm video, and the number of the selected alarm will start blinking.

Press the **SEARCH** button to cancel the search mode.

Operation returns to the normal screen.

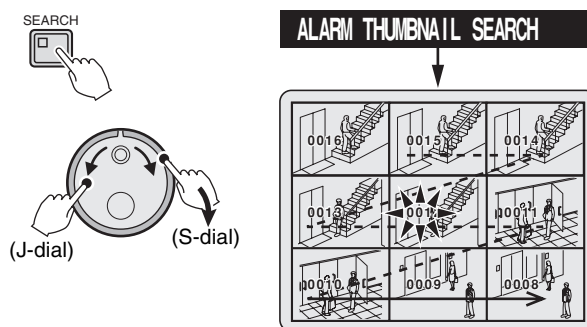

3 Turn the **J-dial**, select the desired alarm number (**blinks**), and turn the **S-dial** clockwise.

The selected video is played in full-screen mode. When the selected video is over, playback pauses.

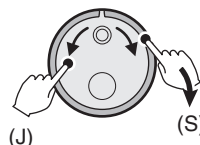

4 Press the **PLAY/STOP** button.



Viewing pre-alarm video

After beginning playback of an alarm recording identified by an alarm search, turn the **S-dial** counterclockwise.



- Identical to alarm searching, playback is only possible within each individual alarm recording. Play the previous and next alarm recordings using the **ALARM** buttons.
- The **S-dial**, the **J-dial** and the front panel buttons can be used for operations such as pause and fast-forward.

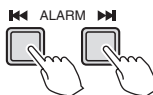

Searching for recorded video

C Date/time search

1 Press the **SEARCH** button during recording or live video.

2 Turn the **J-dial**, select "**TIME/DATE SEARCH**", and turn the **S-dial** clockwise.

The cursor moves to "**CHANNEL**".

Press the **SEARCH** button to cancel the search mode.

Operation returns to the normal screen.

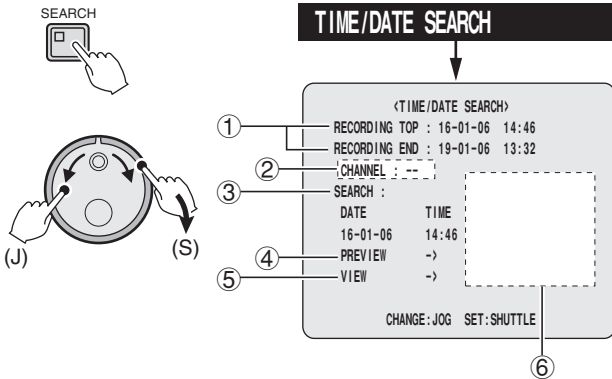

(Menu item - Description)

- 1 RECORDING TOP/RECORDING END:**
Automatically displays the date/time of the first and the last (most recent) recorded videos. These fields cannot be modified.
- 2 CHANNEL:**
Setting the channel (camera number) for playback.
- 3 SEARCH:**
Setting the date/time for playback.
- 4 PREVIEW:**
When selected, displays the preview screen.
- 5 VIEW:**
When selected, plays the previewed recording in full-screen mode.
- 6 Preview screen area**

3 Searching by date and time.

Example: Recording from camera 3 from 8:30pm on October 26, 2006

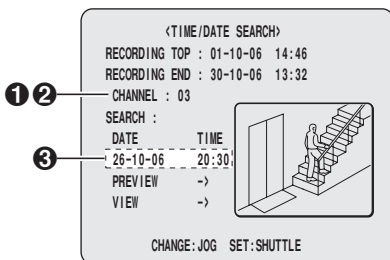

- 1** Turn the **S-dial** clockwise.
- 2** Select "**03**" by turning the **J-dial**, and turn the **S-dial** clockwise twice.
- 3** Select the number using the **J-dial**, and then turn the **S-dial** clockwise to set it. Repeat the procedure until the entire date/time setting is complete.

The cursor moves to "**PREVIEW**".

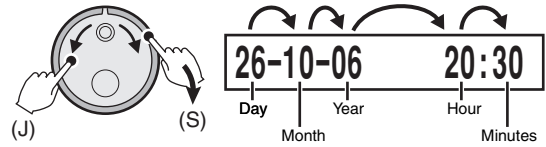

4 Turn the **S-dial** clockwise.

A search progress bar is displayed during searching, followed by recording of the specified date and time displayed in the preview screen.

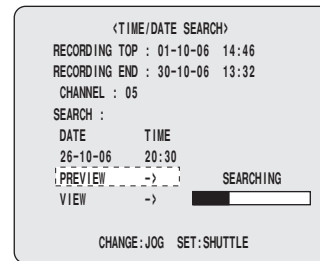

If no recording exists for the specified time:

The recording closest to the specified time is displayed.

Viewing the preview screen

Turn the **J-dial**, select "**VIEW**", and turn the **S-dial** clockwise.

The selected video is played in full-screen mode.



If a date/time search is performed on alarm recordings or programmed recordings by specifying the channel, depending on the recording circumstances, the desired video may not be found. In this case, try the date/time search again without specifying the channel. Start playback, and use fast-forward and fast-reverse to locate the video from the desired channel.

- Note:**
- The retrieved video can be displayed in full-screen mode without displaying the preview screen by entering the channel, date and the time and by selecting "**VIEW**".
 - The S-dial, the J-dial and the front panel buttons can be used for operations such as pause and fast-forward.
 - If "**CHANNEL**" is set to "--", then playback will be displayed in multi-screen mode.

Searching for recorded video

D Archive area search

Plays back video stored in the archive area.

- 1 Press the **SEARCH** button during recording or live video.

- 2 Turn the **J-dial**, select "**ARCHIVE AREA SEARCH**", and turn the **S-dial** clockwise.

The <ARCHIVE AREA SEARCH> screen is displayed. The eight most recent archive recordings are displayed in the order of archiving.

- Press the **SEARCH** button to cancel the search mode.

Operation returns to the normal screen.

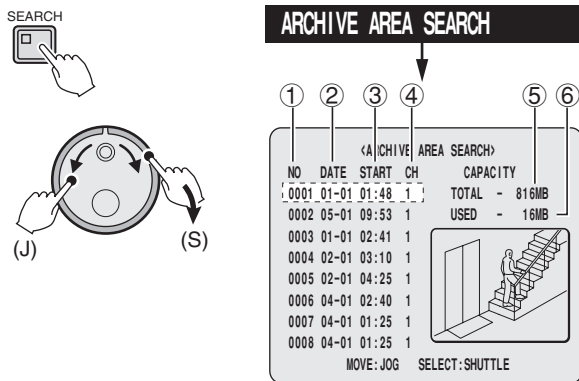

(Menu item - Description)

- 1 **NO:**
Displays the number of the archive.
- 2 **DATE:**
Displays the date of recording.
- 3 **START:**
Displays the start time of recording.
- 4 **CH:**
Displays the lead channel (camera number) of the recording.
- 5 **TOTAL:**
Displays the total capacity of the archive area.
- 6 **USED:**
Displays the amount of the archive area that has been used.

- 3 Select the desired "NO" by turning the **J-dial**, and turn the **S-dial** clockwise.

The selected video is displayed in the preview screen, and playback starts in full-screen mode. When the selected video is over, playback pauses.

- 4 Press the **PLAY/STOP** button.



E Motion detection search

- Select the search area and the channel number on the <MOTION DETECTION SEARCH 1> screen. Selecting the <START PREVIEW> will display the <MOTION DETECTION SEARCH 2> screen.
- The <MOTION DETECTION SEARCH 2> screen displays the specified search area and channel number. Set the start and end date/time, and select "MOTION SENSOR" to display the motion sensor setting screen.
- On the motion sensor setting screen, set the motion sensor for the recorded images and detect scenes where images were changed by intruders etc.

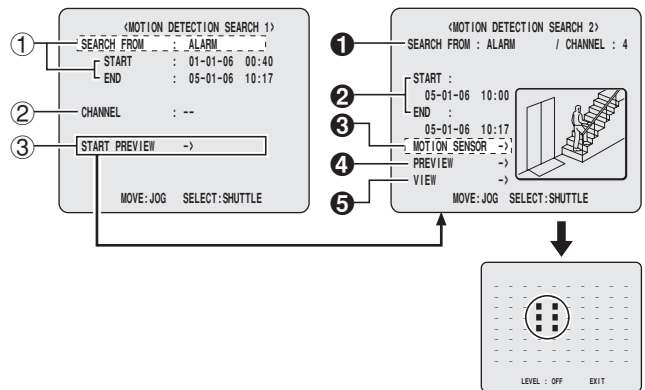

(Menu item - Description)

<MOTION DETECTION SEARCH 1> screen

1 SEARCH FROM/START/END

When selecting a recording area for the motion sensor setting, the date and time of the first and last recording in the selected recording area will be displayed automatically. The starting and ending date and time cannot be changed.

Selections:

- ALARM:** Searches video from the alarm recording area.
- NORMAL:** Searches video from the normal recording area.
- ALARM & NORMAL:** Searches video from the alarm recording area and the normal recording area.

2 CHANNEL

Use this menu item to select the channel for the motion sensor.

3 START PREVIEW

Search is performed based on the above selected area and channel and the <MOTION DETECTION SEARCH 2> screen is displayed.

<MOTION DETECTION SEARCH 2> screen

1 SEARCH FROM/CHANNEL

Displays the settings selected on the <MOTION DETECTION SEARCH 1> screen.

2 START/END

Used to set the start and end time of the search area and specified channel.

3 MOTION SENSOR

Displays the motion sensor setting screen.

4 PREVIEW

When selected, displays the preview screen.

5 VIEW

The video found by the search function is played in full-screen mode.

Searching for recorded video

E Motion detection search (continued)

1 Press the **SEARCH** button during recording or live video.

2 Turn the **J-dial**, select "**MOTION DETECTION SEARCH**", and turn the **S-dial** clockwise.

The <MOTION DETECTION SEARCH 1> screen appears.

The "SEARCHING" starts blinking.

Press the **SEARCH** button to cancel the search mode.

Operation returns to the normal screen.

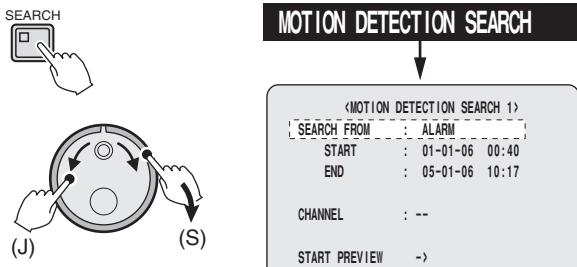

3 Turn the **S-dial** clockwise.

The "ALARM" starts blinking.

4 Select the desired recording area (example: **ALARM & NORMAL**) by turning the **J-dial**, and then turn the **S-dial** clockwise.

Selections: ALARM/NORMAL/ALARM & NORMAL

"SEARCHING" of END starts blinking again, the search is over.



5 Select **CHANNEL** by turning the **J-dial** and then turn the **S-dial** clockwise.

The "--" starts blinking.

6 Select the desired channel (example: camera 4) by turning the **J-dial**, and then turn the **S-dial** clockwise.

The cursor moves to the START PREVIEW field.



7 Turn the **S-dial** clockwise.

The screen switches to the <MOTION DETECTION SEARCH 2> screen, and the channel 4 preview screen is displayed.

8 Turn the **S-dial** clockwise, and set the number using the **J-dial**. Turn the **S-dial** clockwise again, and repeat this to set the date and time for the start of the search.

Example: October 28, 2006 8:30pm

When the settings are complete, turn the **S-dial** clockwise.



9 Repeat the same steps as shown at **8** to set the end date and time for the search.

Example: November 29, 2006 8:30pm

The cursor moves to the MOTION SENSOR field.



10 Turn the **S-dial** clockwise.

The motion sensor setting screen is displayed.

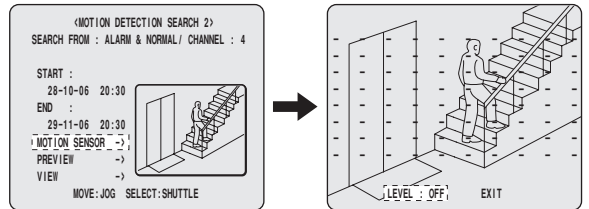

11 **Setting the motion sensor**

1 Turn the **J-dial** to move the cursor to the desired position of the sensor, and then turn the **S-dial** clockwise.

--: Sensor is not set

█: Sensor is set

After switching the sensor from unset to set, the same operation can be used to set sensors at other locations.

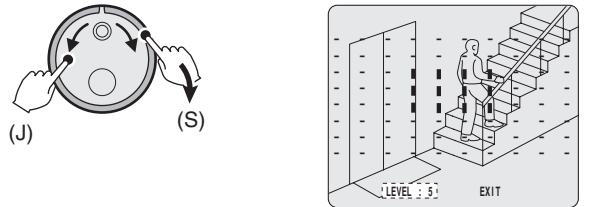

2 Turn the **J-dial** to move the cursor to "**LEVEL: OFF**", and then turn the **S-dial** clockwise.

The "OFF" starts blinking.

Selections: OFF/1/2/.../9/10 (low sensitivity)

3 Turn the **J-dial** to set "**LEVEL: OFF**" to [5], and then turn the **S-dial** clockwise twice.

The <MOTION DETECTION SEARCH 2> screen returns.

For searching the "PREVIEW" or "VIEW" screens, continue at P26 without exiting the current search.

12 Press the **SEARCH** button to exit the search mode.

The normal live video display returns.



If you set the motion search to a specific channel (camera number), only the video from the specified channel will be played. The camera title, date and time may not be displayed fully on the screen.

Searching for recorded video

E Motion detection search (continued)

■ Motion sensor settings verification using the preview screen

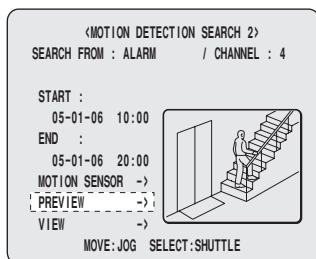

- 1 Turn the J-dial to move the cursor to "PREVIEW", and then turn the S-dial clockwise.

The detected image is displayed on the preview screen.

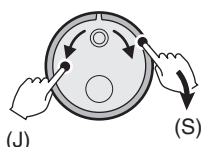

- ⓘ If "NOT FOUND" is displayed, set the motion sensors once again.
- ⓘ Each time the S-dial is turned clockwise, the images detected by the motion sensor are displayed on the preview screen.

- 2 Press the SEARCH button to exit the search mode. The normal live video display returns.



■ Full-screen viewing of video detected by the motion sensor

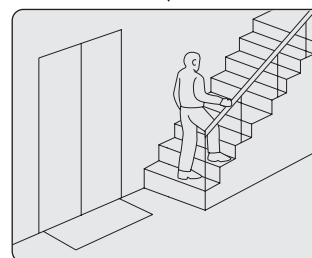
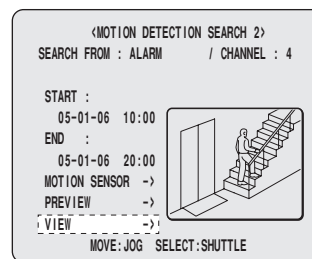

- 1 Turn the J-dial to move the cursor to "VIEW", and then turn the S-dial clockwise.

Normal playback starts from the selected image. When the video is over, playback pauses.

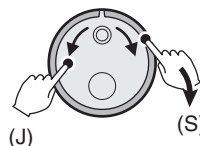

To search a recording from a different channel, stop the current playback and then repeat the setting process from the beginning.

- 2 Press the PLAY/STOP button.



Copying recorded video to media

Selected video stored in the normal recording area and the alarm recording area can be copied to various media (full screen). Images copied to a CompactFlash card can be directly printed on a printer.

A Copying video from the normal or alarm recording area to the archive area (P28)

We recommend using this area to store video only for quick verification, not as a permanent storage.

If complete archival is required, copy to media such as a CompactFlash card.

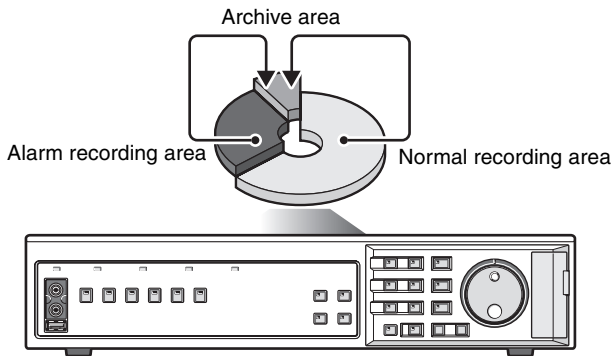

- Verify the available recording space in the archive area before copying.
- If the available archive area is insufficient, copy the archive area to media such as a CompactFlash card, and erase the archive area.

B Copying video from the internal hard disk to the CD-R/RW (P29)

Before copying, connect the CD-R/RW drive to the USB connector on the front or the rear panel.

If the CD-R/RW drive connection is not confirmed the selections of the CD-R/RW under the COPY TO are not displayed.

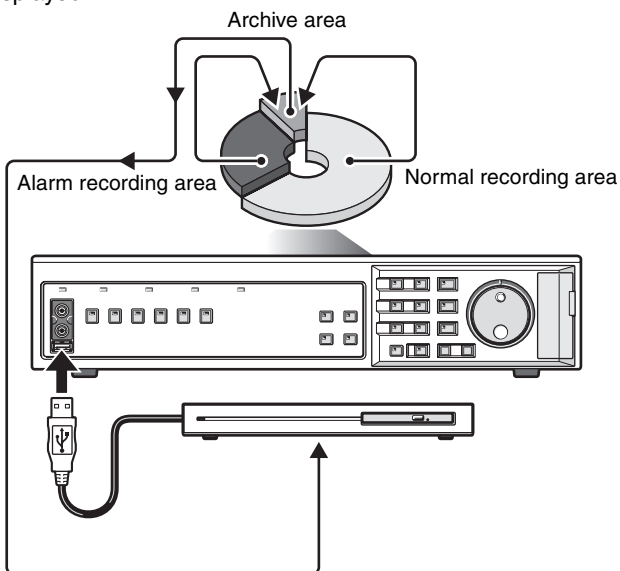

C Copying video from the internal hard disk to media such as a CompactFlash card (P30)

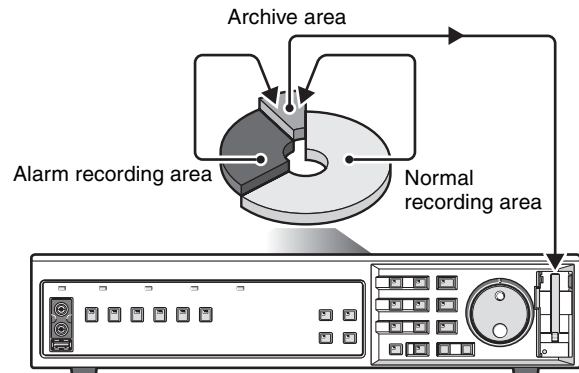

- When video is being copied from the normal or the alarm recording area to media such as a CompactFlash card, the video is temporarily stored in the archive area, and then copied to the media. Always check for sufficient archive space before copying.
- Copying video to a CompactFlash card takes about 15 seconds per 1MB. If the recording capacity becomes full during the copying operation, the message "COMPACT FLASH FULL!" appears and the copying operation finishes. Press any key to return to the normal screen. Repeat the copy procedure with a CompactFlash card that has sufficient recording space.
- Video copied to a CompactFlash card or CD-R/RW includes a tampering detection code. Contact the store where you purchased your device regarding the detection of tampering occurrences.
- Video copied to a CompactFlash card or CD-R/RW with audio attached can be played using the DVR Viewer 2. Refer to the separate "Manual for Remote Operation using a Network Connection" for more information.
- JPEG images are handled as field images. If viewing the images using a commercial image processing software, select "CF→PRINT". Standard copies will display the vertical direction compressed to 50% of its original so please use the "DVR Viewer 2".

D Printing images directly from the CompactFlash card or the Microdrive. (P31)

In order to print the recorded images, the media must be formatted on the DVR before use.



Only FAT16 CompactFlash cards can be formatted on the DVR. The DVR will not recognize FAT32 cards.

Copying recorded video to media

A Copying video (example: 10 seconds) from the normal or alarm recording area to the archive area

1 Start playback from the normal or alarm recording area.

2 Press the **STILL** button at the image to be copied.
The image is paused.



3 Press the **COPY** button.
The copy setting screen is displayed.
The cursor moves to the "COPY TO" field.

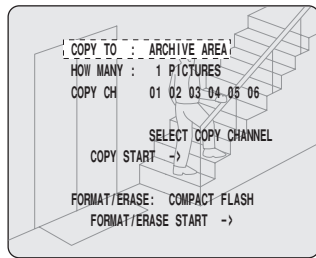
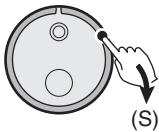

4 Turn the **S-dial** clockwise.
"ARCHIVE AREA" starts blinking.

5 Turn the **J-dial** to select **COPY TO "ARCHIVE AREA"**, and then turn the **S-dial** twice clockwise.
The cursor moves to the 1 of the "HOW MANY" field.

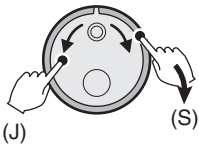

COPY TO : ARCHIVE AREA

Selections:
ARCHIVE AREA, COMPACT FLASH, CF→PRINT, CD-R/RW

6 Turn the **J-dial** to select **HOW MANY "10"**, and then turn the **S-dial** clockwise.
The "PICTURES" starts blinking.

HOW MANY: 10 PICTURES

Select a value between 1~99.

7 Turn the **J-dial** to select "**SECONDS**", and then turn the **S-dial** clockwise.
The cursor moves to "COPY START".

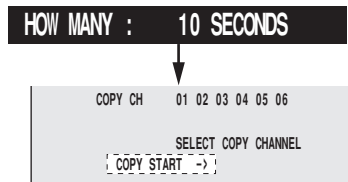
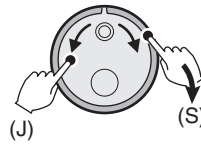

Selections:
PICTURES: (1~99)
Copies the specified number of images.
SECONDS: (1~99)
Copies the specified duration in seconds.
MINUTES: (1~99)
Copies the specified duration in minutes.

8 Select the channel to be copied (Example: 03, 05) using the camera selection button.

The selected channel changes from grey to white.
• The default channel is green. The channel in green can not be modified.

Press the COPY button to cancel the current copy operation.

9 Turn the **S-dial** clockwise to start copying.
• Copying to the archive area starts, and the "**COPY TO ARCHIVE AREA !**" message is displayed.
• When copying is complete, the "**COPY FINISHED !**" message is displayed.

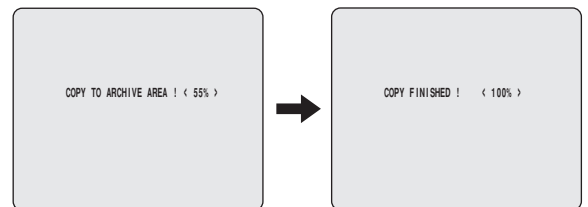
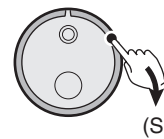

Even if a video with audio attached is copied to the archive area only the images are copied.

Copying recorded video to media

B Copying video (example: 10 seconds) from the internal hard disk to the CD-R/RW drive

1 Connect the optional CD-R/RW drive to the USB connector on the front or rear panel of the DVR.
If the front and the rear USB terminal are connected simultaneously the front is given priority.

2 Start playback from the normal, alarm or the archive area.

3 Press the STILL button at the image to be copied.
The image is paused.



4 Press the COPY button.
The copy setting screen is displayed.
The cursor moves to the "COPY TO" field.

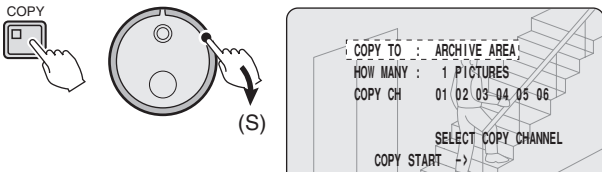

5 Turn the S-dial clockwise.
"ARCHIVE AREA" starts blinking.

6 Turn the J-dial to select COPY TO "CD-R/RW", and then turn the S-dial twice clockwise.
The cursor moves to the 1 of the "HOW MANY" field.

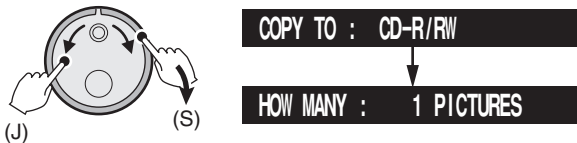

Selections:

ARCHIVE AREA, COMPACT FLASH, CF→PRINT, CD-R/RW

7 Turn the J-dial to select HOW MANY "10", and then turn the S-dial clockwise.
The "PICTURES" starts blinking.
Select a value between 1~99, >99.

8 Turn the J-dial to select "SECONDS", and then turn the S-dial clockwise.
The cursor moves to "COPY START".

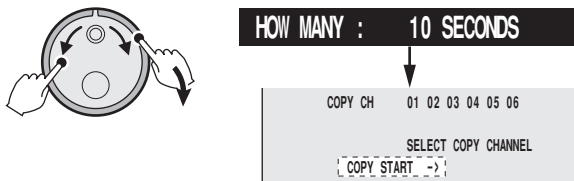

Selections:

PICTURES, SECONDS, MINUTES, EVENTS
• EVENTS allows you to copy the data of the archive area per event. Selecting >99 fills the capacity regardless of the event.

9 Select the channel to be copied (Example: 03, 05) using the camera selection button.

The selected channel changes from grey to white.
• The default channel is green. The channel in green can not be modified.

Press the COPY button to cancel the current copy operation.

10 Turning the S-dial clockwise displays the CD-R/RW writing confirm screen.
The cursor moves to "FINALIZE".

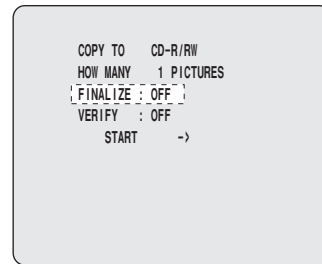

11 Turn the S-dial clockwise, select the FINALIZE settings using the J-dial and turn the S-dial clockwise.

ON: Finalizes the disc. Once the disc is finalized the disc is not recordable.
OFF: The disc is not finalized. The disc recording can be interrupted.
The cursor moves to "VERIFY".

12 Turn the S-dial clockwise, select the VERIFY setting using the J-dial and turn the S-dial clockwise.

ON: The writing status is verified once the disc writing is complete.
OFF: The disc writing status is not verified once the disc writing is complete.
The cursor moves to "START→".

13 Turn the S-dial clockwise.

Copying to CD-R/RW starts and the following messages are displayed during the copying operation.
↓ COPY TO CD-R/RW ! <----> → <0%> → <100%>
↓ (If FINALIZE is set to OFF)
CLOSING CD-R/RW ! PLEASE WAIT !
↓ (If FINALIZE is set to ON)
FINALIZING CD-R/RW ! PLEASE WAIT !
↓ COPY FINISHED ! < 100% >



If a new disk (CD-RW) or an erasable disc is used for the copying, format the disc before use.

Copying recorded video to media

C Copying video (example: 10 pictures) from the internal hard disk to media such as a CompactFlash card

Copy to a Microdrive is also possible, up to 2GB.

- 1** Insert the card into the CompactFlash card slot.
Refer to the names and functions of parts when inserting the card. (P9)
- 2** Start playback from the normal, alarm or the archive area.
- 3** Press the STILL button at the image to be copied.
The image is paused.



- 4** Press the COPY button.
The copy setting screen is displayed.
The cursor moves to the "COPY TO" field.

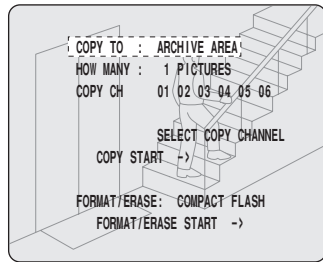
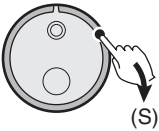

- 5** Turn the S-dial clockwise.
"ARCHIVE AREA" starts blinking.
- 6** Turn the J-dial to select COPY TO "COMPACT FLASH", and then turn the S-dial twice clockwise.
The cursor moves to the 1 of the "HOW MANY" field.

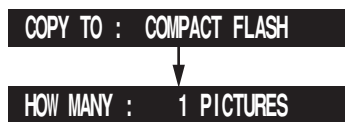
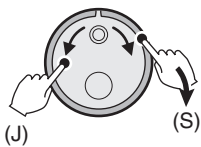

Selections:
ARCHIVE AREA, **COMPACT FLASH**, CF→PRINT, CD-R/RW

- 7** Turn the J-dial to select HOW MANY "10", and then turn the S-dial clockwise.
The "PICTURES" starts blinking.
Select a value between 1~99, >99.
- 8** Turn the J-dial to select "PICTURES", and then turn the S-dial clockwise.
The cursor moves to "COPY START->".

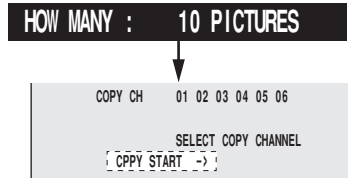
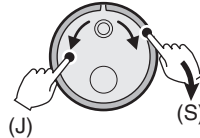

Selections:

PICTURES, SECONDS, MINUTES, EVENTS
• EVENTS allows you to copy the data of the archive area per event. Selecting >99 fills the capacity regardless of the event.

- 9** Select the channel to be copied (Example: 03, 05) using the camera selection button.
The selected channel changes from grey to white.
• The default channel is green. The channel in green can not be modified.
- Press the COPY button to cancel the current copy operation.
- 10** Turn the S-dial clockwise to start copying.
• Copying to the CompactFlash card starts, and the "COPY TO COMPACT FLASH!" message is displayed.
• When copying is complete, the "COPY FINISHED!" message is displayed.

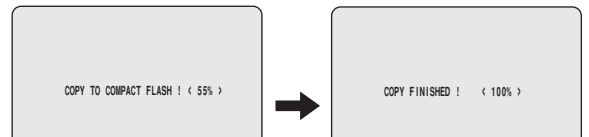
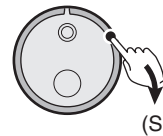

Refer to P32 for viewing the images copied to the CompactFlash card.



- Maximum 40,000 images can be copied in a single copy operation. If the length of copying was specified using "MINUTES", copying will end at 40,000 images.
- Alarm recordings played using the Alarm Search or the Alarm Thumbnail Search are copied one event at a time.
- Format the CompactFlash card (FAT16) using this equipment. Formats done using FAT 32 will not be recognized.

Copying recorded video to media

D Printing images directly from the CompactFlash card or the Microdrive

1 Insert the card into the CompactFlash card slot.
Refer to the names and functions of parts when inserting the card. (P9)

2 Start playback from the normal, alarm or the archive area.

3 Press the STILL button at the image to be printed.
The image is paused.



4 Press the COPY button.
The copy setting screen is displayed.
The cursor moves to the "COPY TO" field.

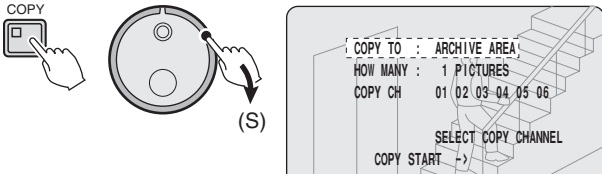

5 Turn the S-dial clockwise.
"ARCHIVE AREA" starts blinking.

6 Turn the J-dial to select COPY TO "CF→PRINT", and then turn the S-dial twice clockwise.
The cursor moves to the 1 of the "HOW MANY" field.



Selections:
ARCHIVE AREA, COMPACT FLASH, CF→PRINT, CD-R/RW

7 Turn the J-dial to select HOW MANY "10", and then turn the S-dial clockwise.
The "PICTURES" starts blinking.



8 Turn the J-dial to select "PICTURES", and then turn the S-dial clockwise.
The cursor moves to "COPY START".

Selections:

- PICTURES:** (1~99)
Prints the specified number of images.
- SECONDS:** (1~99)
Prints the images of the specified duration in seconds.
- MINUTES:** (1~99)
Prints the images of the specified duration in minutes.
- EVENTS:** (1~99, >99)
Prints the archive area data specified in units of events.

9 Select the channel to be copied (Example: 03, 05) using the camera selection button.

The selected channel changes from grey to white.

- The default channel is green. The channel in green can not be modified.

☞ Press the COPY button to cancel the current copy operation.

10 Turn the S-dial clockwise.
A folder named "DCIM" is created under the root directory, followed by a sub-folder with the date of the copied images.

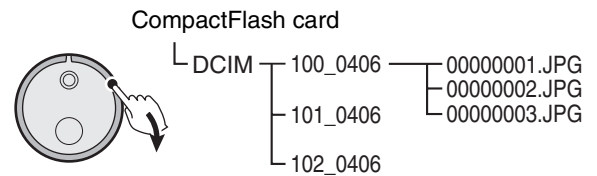

☞ Use the EXIT/OSD button to switch the position of the date or to hide it for printing. (P14)



- Maximum 999 images can be printed in a single printing operation. Even if 10-minutes duration is selected, printing will end at 999 images.
- If "CF→PRINT" is selected, the time necessary to copy is about twice as long as (1MB per 30 seconds) when "COMPACT FLASH" is selected.
- Use the SANYO DVP-P1 Digital Photo Printer. Operation is not guaranteed if using another printer.

Copying recorded video to media

CompactFlash cards or CD-RW formats

CompactFlash format

- If no CD-R/RW driver is connected to the USB terminal, the format of the CompactFlash is given priority.
- The Microdrive can be formatted in the same way.

- 1** Insert the CompactFlash card in the CompactFlash card slot. (P9)
- 2** Press the PLAY/STOP button, the STILL button, and the COPY button.
The COPY TO screen is displayed.
- 3** Move the cursor to "FORMAT/ERASE START" on the last row by turning the J-dial and then turn the S-dial clockwise.
- 4** The <WARNING> screen is displayed and the message "NO" blinks. Turn the J-dial and select "YES" and then turn the S-dial clockwise.
Formatting (initializing) starts.

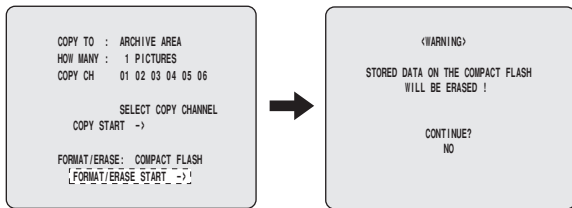

CD-RW format

- 1** Connect the CD-RW driver to the USB terminal and insert a CD-RW disc.
If the front and the rear USB terminal are connected simultaneously the front is given priority.
- 2** Move the cursor to "FORMAT/ERASE" by turning the J-dial and turn the S-dial clockwise.
"COMPACT FLASH" blinks.
- 3** Select "CD-RW" by turning the J-dial and then turn the S-dial twice clockwise.
- 4** Move the cursor to "FORMAT/ERASE START" on the last row by turning the J-dial and then turn the S-dial clockwise.
- 5** The <WARNING> screen is displayed and the message "NO" blinks. Turn the J-dial and select "YES" and then turn the S-dial clockwise.
Formatting (initializing) starts.

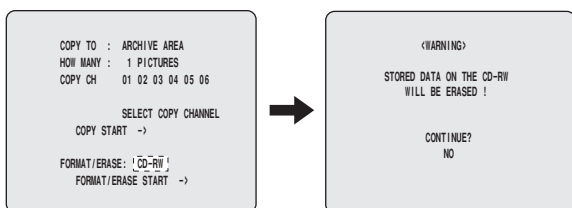

Viewing Images copied to a CompactFlash card and CD-R/RW on a PC

Copying video to a CompactFlash and a CD-R/RW creates the following folders and saves the images.

With a CompactFlash

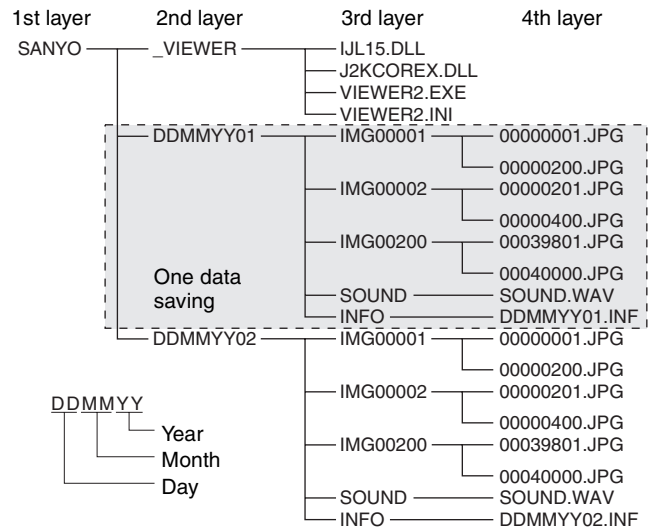

With a CD-R/RW

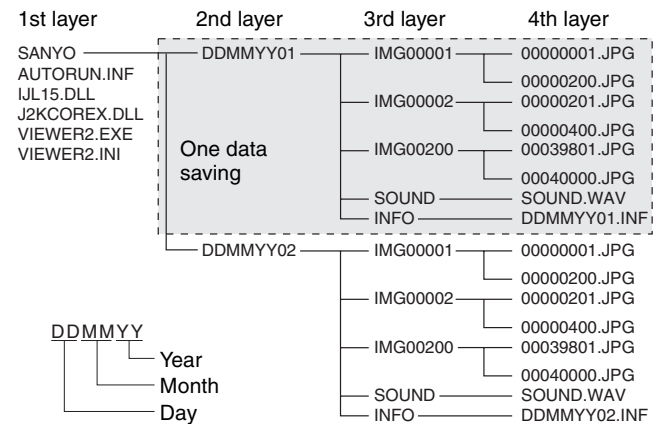

- Each image folder contains 200 images. If the number of images exceeds 200 they are placed in the next folder.
- A SOUND.WAV file is created in the SOUND folder.

Main menu configuration

The main menu consists of seven items, and can be displayed by pressing the MENU button.

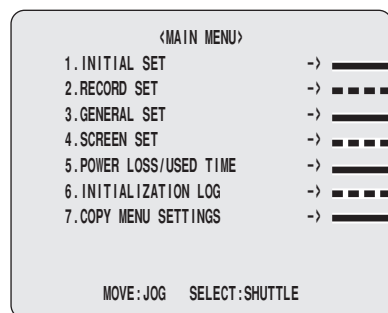

Entering numbers using buttons

Normally, numeric values and channels (camera numbers) are set using the J-dial, but camera selection buttons and the four buttons on the front panel can also be used for settings.

A value can be input using the button below when "K" is displayed on the upper right corner of the screen.



- QUAD buttn: 7 is entered.
- MULTI buttn: 8 is entered.
- MON2 buttn: 9 is entered.
- PLUS buttn: 0 is entered.
- Camera selection buttons 1~6:
Enters the number of the button pressed.



Copy the contents of the menu settings of this DVR and operate another unit of the same model with the same setting (P79)

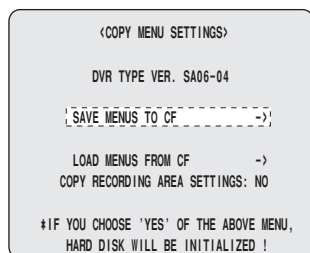

Initial settings (P34)

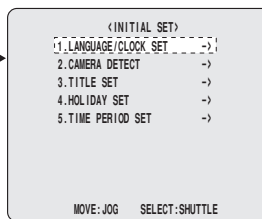

Recording and alarm settings (P39)

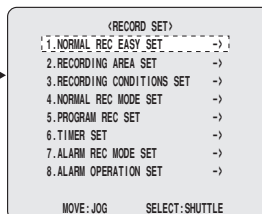

Generic settings (P62)



Screen settings (display shunt, automatic scrolling, masking, tone adjustment) (P71)

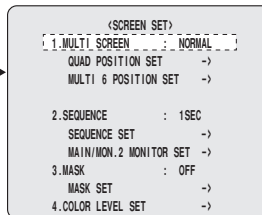

Power outage time, hard disk's hours of use, etc. (P77)

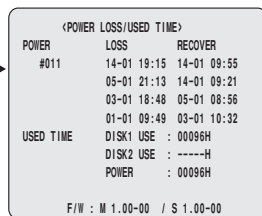

Hard disk initialization log display (P78)

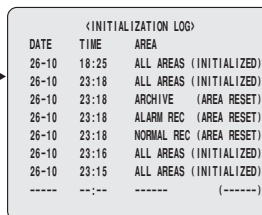

Initial settings

Menu configuration

■ Displaying the initial settings screen

- 1 Press the MENU button.
The <MAIN MENU> screen is displayed.

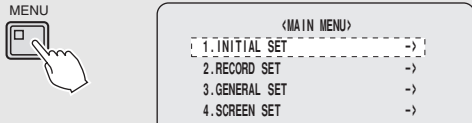

- 2 Turn the S-dial clockwise, turn the J-dial to select the submenu and then turn the S-dial clockwise

The <INITIAL SET> screen is displayed.
The selected screen (A~E) is displayed. Refer to the appropriate pages for the settings.

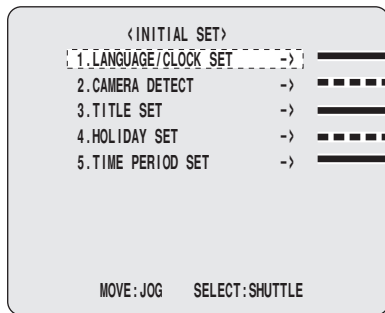

A Language setting

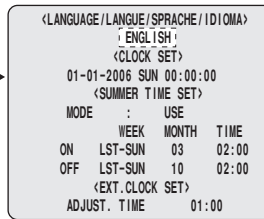

☞ Language, Clock setting (P13)

Sets the date and time for displaying on the normal screen.

☞ Summer time setting (P35)

☞ External clock setting (P35)

If multiple devices are connected, they can be synchronized to the same clock. Refer to **Figure 1** for the proper connections.

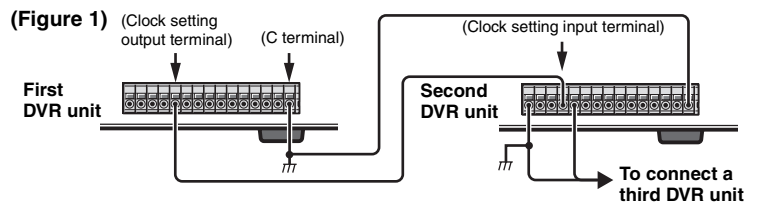

B Camera detection (P35)



Automatically detects the cameras connected to the DVR.

C Title setting (P36)



Sets a unique title for each camera, for example the name of the location it is placed. The titles are displayed on the monitor.

D Holiday setting (P36)

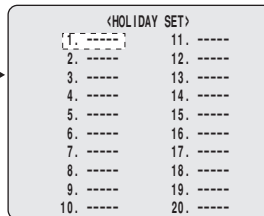

Sets the specified days as holidays. Public holidays, company holidays can also be set for timer-controlled operation identical to that of Sundays.

E Time period setting (P37)

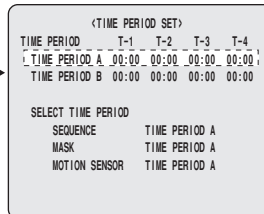

For example, TIME PERIOD A can be set for automatic scrolling display, and TIME PERIOD B can be set for gray pattern masking of camera images.

■ Changing the menu setting conditions while recording

On the <MAIN MENU> screen, press the SHUTTLE HOLD button for approx. 3 seconds. Recording is interrupted, <-> is displayed in the top left corner of the screen and menu conditions can be modified.

Closing the menu returns the state of recording operations automatically.

- Recording operations are not available while <-> is displayed. In case of electric power failure, the state of recording operations is disabled.
- If <●> is displayed in the top left corner of the screen, menu conditions cannot be changed.

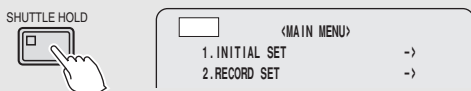

Initial settings

A Summer time setting

Automatic switching from standard time to summer time can be set.

- 1 Display the <LANGUAGE/LANGUE/SPRACHE/IDIOMA> screen as explained in "Displaying the initial settings screen" (P34).

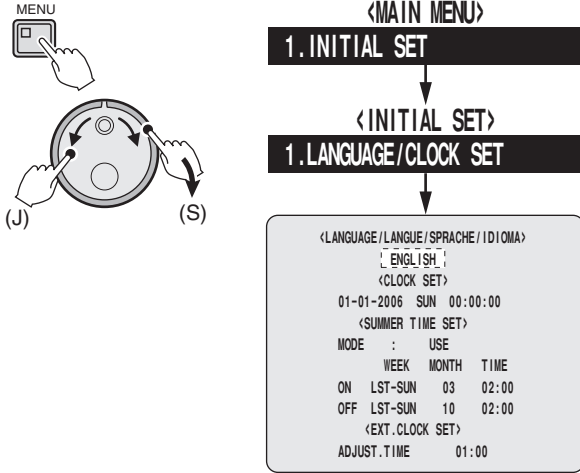

- 2 Turn the J-dial, select the MODE under <SUMMER TIME SET>, and turn the S-dial clockwise. The "USE" starts blinking.

MODE : USE

- 3 Turn the J-dial clockwise, select USE and then turn the S-dial clockwise.

Selections:

USE: Automatic switching to summer time

NO USE: No automatic switching to summer time

The cursor moves to the "ON" field. Set the start and end time of summer time.

	WEEK	MONTH	TIME
ON	LST-SUN	03	02:00
OFF	LST-SUN	10	02:00

- 1 Turn the S-dial clockwise. Move the cursor to the "LST" field under "WEEK".
- 2 Select the week by turning the J-dial, and turn the S-dial clockwise. Repeat the same procedure for setting the MONTH and the TIME fields. The cursor moves to the "OFF" field.

Selections:
WEEK: LST, 1ST, 2ND, 3RD, 4TH-SUN, MON, TUE, WED, THU, FRI, SAT
- 3 Turn the S-dial clockwise to move the cursor to the "LST" field under "WEEK".
- 4 Select the week by turning the J-dial, and turn the S-dial clockwise. Repeat the same procedure for setting the MONTH and the TIME fields.

A-1 External clock setting

Connect the CLOCK OUT terminal of the CONTROL terminal block on the rear panel of the DVR to the CLOCK IN terminal of the second DVR (P34: Figure 1), and move the cursor to <EXT. CLOCK SET>.

- 1 Turn the S-dial clockwise until "01" starts blinking.



- 2 Turn the J-dial to select the ADJUST TIME (example: 05), and then turn the S-dial clockwise. The minutes cannot be set.



- 3 Press the EXIT/OSD button.

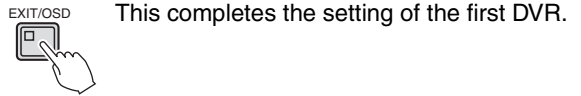

- 4 Display the same menu on the second DVR, set the same hour, and press the EXIT/OSD button.

When the first DVR reaches the set time (5:00), both DVRs will be set to 5:00.

However, the time on the second DVR and other DVRs onward can be adjusted between 4:30 and 5:29.

B Camera detection

- 1 Display the <WARNING> screen as explained in "Displaying the initial settings screen". (P34)

The <WARNING> screen is displayed, and "NO" is blinking.

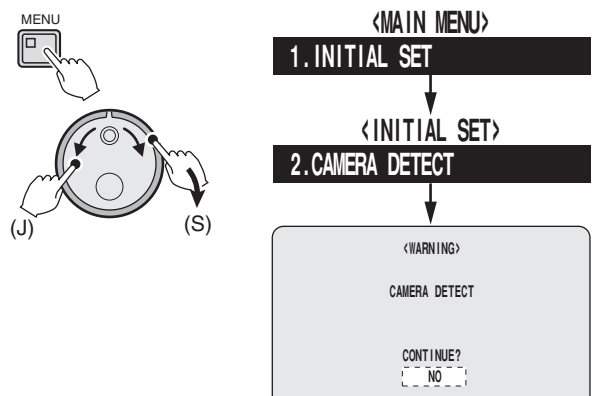

- 2 Turn the J-dial, select "YES", and turn the S-dial clockwise.

After detecting the connected cameras, the display returns to the <INITIAL SET> screen. Press the EXIT/OSD button.



Initial settings

C Title setting

Titles for each camera can be up to 10 characters.

- 1 Display the <TITLE SET> screen as explained in "Displaying the initial settings screen" (P34).
The monitor shows live video, and the <TITLE SET> screen is displayed.

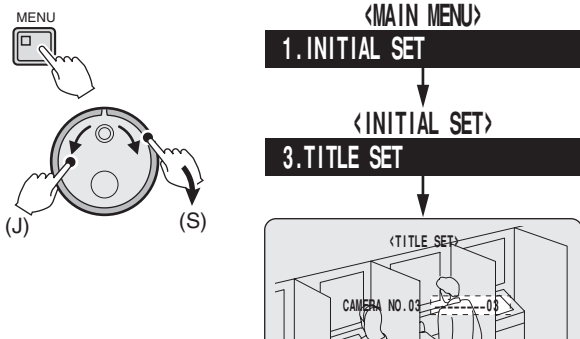

- 2 Enter a title for camera 3.

Example: Display ATM-1F

- 1 Press camera selection button 3, and then turn the S-dial clockwise.
The first dash (" _ ") of the title setting starts blinking.

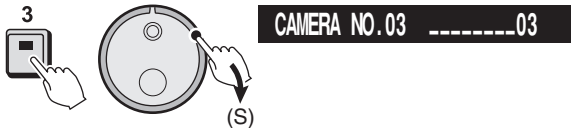

- 2 Turn the J-dial, select "A", and then turn the S-dial clockwise.
When "A" is accepted, the cursor moves to the next position.
Repeat the same procedure to enter the title.

Character table for Camera title

A	B	C	D	E	F	G	H	I	J	K	L	M	N	O	P	Q	R	S	T	U
V	W	X	Y	Z	0	1	2	3	4	5	6	7	8	9	-	:	.	/	*	



Modifying the title

Turn the S-dial to make the desired letter blink, and then use the J-dial to modify it.

- 3 Press the EXIT/OSD button when the settings are complete.



D Holiday setting

Setting conditions

Set the start and end time for Sunday (SUN) using the <TIMER SET>, and then switch the "SET" to "ON". (P51)

WEEK	START	STOP	PROGRAM	FPS	ON/OFF
SUN	08:00	18:00	OFF	12.5 FPS	ON
MON	--:--	--:--	OFF	12.5 FPS	OFF
TUE	--:--	--:--	OFF	12.5 FPS	OFF

- 1 Display the <HOLIDAY SET> screen as explained in "Displaying the initial settings screen" (P34).
The <HOLIDAY SET> screen appears and the cursor moves to "1".

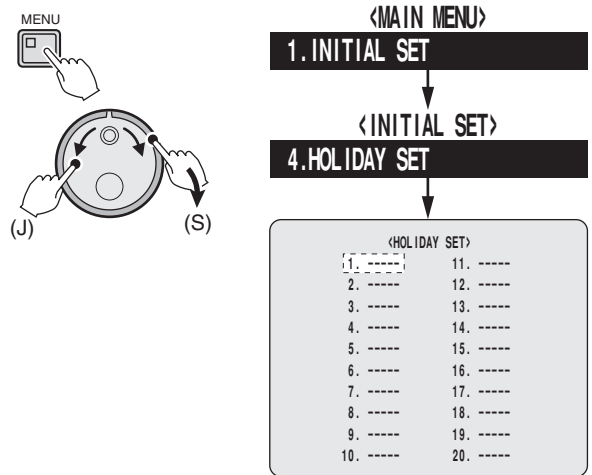

- 2 Enter the date to be set as a holiday.

Example: October 17

- 1 Turn the S-dial clockwise, and use the J-dial to set "17" (day).
- 2 Turn the S-dial clockwise, and use the J-dial to set "10" (month).
Repeat the same procedure to enter all the numbers.

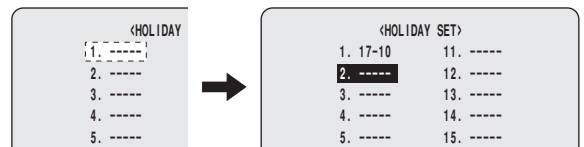

- 3 Press the EXIT/OSD button when the settings are complete.



Initial settings

E Time period setting

The time period setting allows for using different settings, such as automatic scrolling, masking, motion sensor detection settings for four periods of the day (for example: early morning, morning, daytime and evening). There are two timers (A and B) that can be set to control time periods as shown below, allowing for a wide variety of settings to suit every surveillance need.

Example: Time period A

- 6:30 – 11:30
Automatic screen scrolling

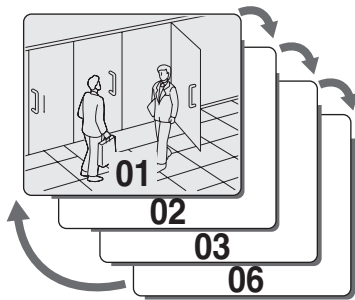

- 11:30 – 13:30
Mask setting for unnecessary areas

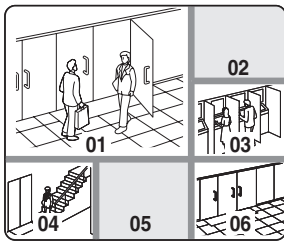

- 13:30 – 18:30
Automatic screen scrolling

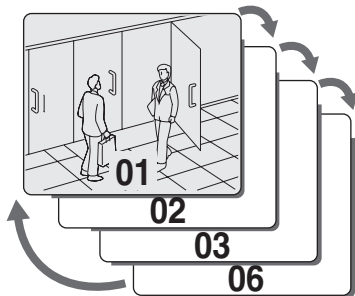

- 18:30 – 6:30
Motion sensor setting

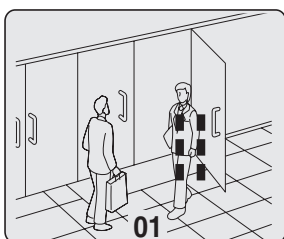

- 1 Display the <TIME PERIOD SET> screen as explained in "Displaying the initial settings screen" (P34).

The <TIME PERIOD SET> screen appears.

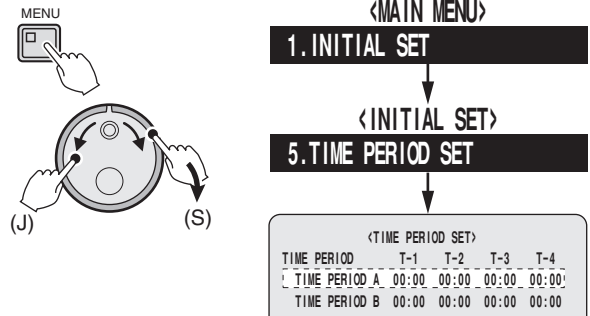

- 2 Set the timing for TIME PERIOD A.

Example:

T-1: 6:30am, T-2: 11:30am, T-3: 1:30pm, T-4: 6:30pm

- 1 Turn the S-dial clockwise.

The first "00" of "T-1" starts blinking.

TIME PERIOD	T-1	T-2	T-3	T-4
TIME PERIOD A	00:00	00:00	00:00	00:00

TIME PERIOD A	06	30	11:30	13:30	18:30
---------------	----	----	-------	-------	-------

- 2 Turn the J-dial to select "06" under T-1, and then turn the S-dial clockwise.

- 3 Turn the J-dial to select "30" under T-1, and then turn the S-dial clockwise.

Repeat the same procedure through T-4 to set the timing of the periods.

- 3 Set the timing for TIME PERIOD B.

Example:

T-1: 7:30am, T-2: 10:30am, T-3: 2:30pm, T-4: 7:30pm

TIME PERIOD B	T-1	T-2	T-3	T-4
TIME PERIOD B	00:00	00:00	00:00	00:00

TIME PERIOD B	07	30	10:30	14:30	19:30
---------------	----	----	-------	-------	-------

- 1 Turn the S-dial clockwise.

The first "00" of "T-1" starts blinking.

- 2 Turn the J-dial to select "07" under T-1, and then turn the S-dial clockwise.

- 3 Turn the J-dial to select "30" under T-1, and then turn the S-dial clockwise.

Repeat the same procedure through T-4 to set the timing of the periods, and then turn the S-dial clockwise.

When time setting is accepted, the cursor moves to the automatic scrolling (SEQUENCE).

Initial settings

E Time period setting (continued)

4 Set automatic scrolling, masking or motion sensor for the time periods (A/B).

The default setting for "SELECT TIME PERIOD" is **A** for all items. When the specified time comes, these operations will work in time period A, but more detailed settings are necessary.

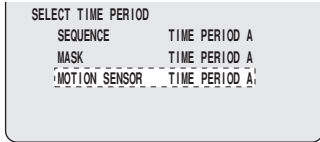

Set the camera video for automatic scrolling (P73)

The main monitor and monitor 2 can have different settings for each of the four time intervals (T-1~T-4).

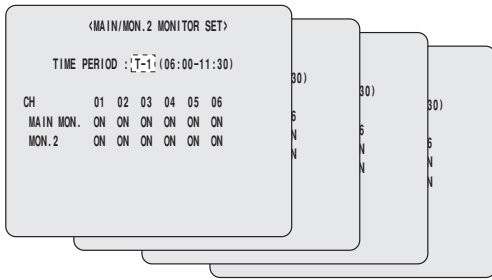

Masking specific camera images (P75)

Unnecessary camera images can be set to invisible for each of the four time intervals (T-1~T-4).

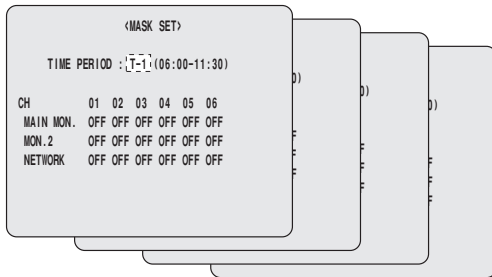

Set motion sensors for camera videos (P58)

Motion sensors can be set for camera videos for each of the four time intervals (T-1~T-4), and use those as alarms for intruders.

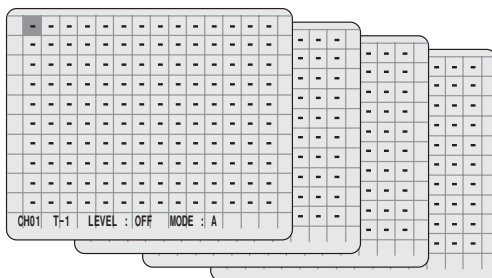

Changing the time period of operations

1 Turn the S-dial clockwise.

The "TIME PERIOD A" of SEQUENCE starts blinking.

2 Select "TIME PERIOD B" by turning the J-dial, and then turn the S-dial clockwise.

Repeat the same procedure to select the time period for MASK and MOTION SENSOR.

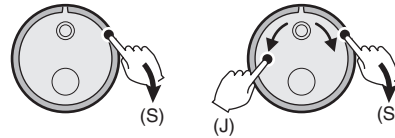

Example:

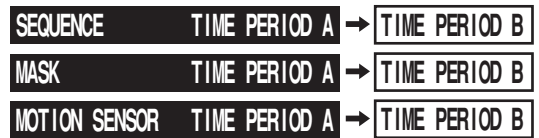

5 Press the EXIT/OSD button when the settings are complete.

The operation returns to the normal screen.



Setting the times for the time periods

- If T-1 ~ T-4 are all set to "00:00", then only T-1 will be valid. T-1 will start at 12:00am (midnight) and end at 12:00am (midnight) of the next day.
- It is not possible to set T-3 and T-4 to a period that would extend into the next day. In this case, set T-4 to "23:59".

TIME PERIOD	T-1	T-2	T-3	T-4
TIME PERIOD A	06:00	12:00	18:00	02:00

- If T-4 is set to "00:00", T-4 becomes invalid and operations skip from T-3 to T-1. The set operation will last from T-3 to T-1.

TIME PERIOD	T-1	T-2	T-3	T-4
TIME PERIOD A	06:00	12:00	18:00	00:00

Recording settings

Menu configuration

■ Displaying the recording settings screen

- 1** Press the MENU button and use the J-dial to select "2. RECORD SET", and then turn the S-dial clockwise.

The <RECORD SET> screen appears.

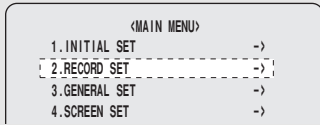
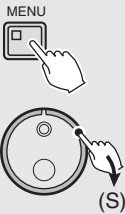

- 2** Turn the J-dial, select the desired submenu, and turn the S-dial clockwise.

The selected screen (A~H) is displayed. Refer to the appropriate pages for the settings.

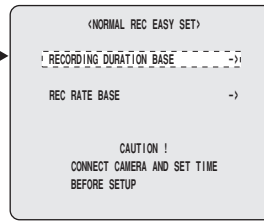
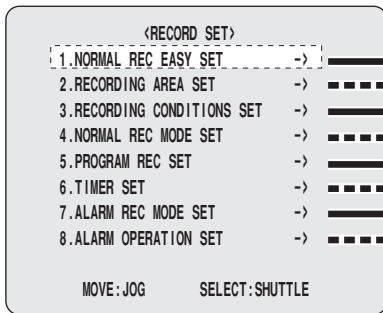
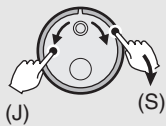

A Easy recording settings (P40)

The recording duration or rate can be selected.
RECORDING DURATION BASE (P41)
 Sets the standard recording duration
REC RATE BASE (P42)
 Sets the standard recording rate

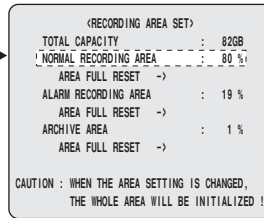

B Recording area settings (P43)

Displays the total capacity of the internal hard disk. The recording capacity for each area (normal, alarm recording and archive) can be set.



C Recording conditions setting (P46)

Specifies settings such as allowing overwrite or stopping instead when the normal or alarm recording area of the internal hard disk is full.

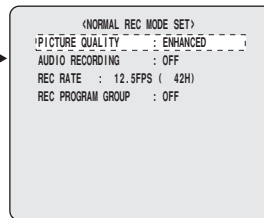

D Normal recording settings (P49)

Sets the image quality, audio, recording rate and programmed recording.

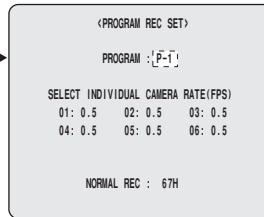

E Programmed recording settings (P50)

Sets the recording rate of the recording camera.

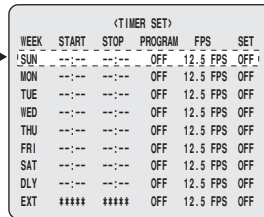

F Timer settings (P51)

Sets the recording according to day of the week and time.

G Alarm operation/display settings (P60)

Sets the operation and display to use at alarm detection.

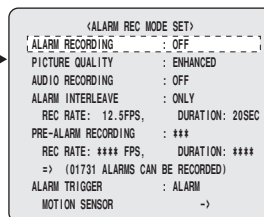
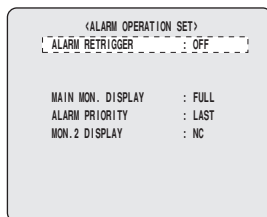

H Alarm recording settings (P55)

Sets the alarm recording, pre-alarm recording and motion sensors.

Recording settings

A Easy recording menu description

The following two easy settings are available.

RECORDING DURATION BASE (P41)

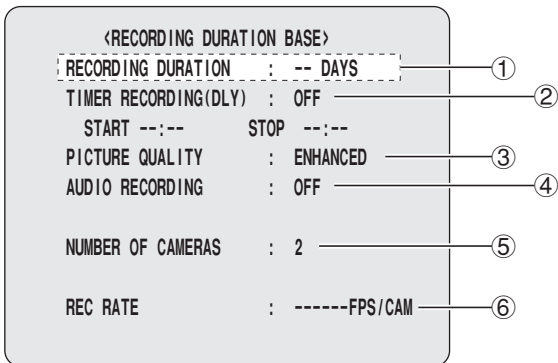

REC RATE BASE (P42)

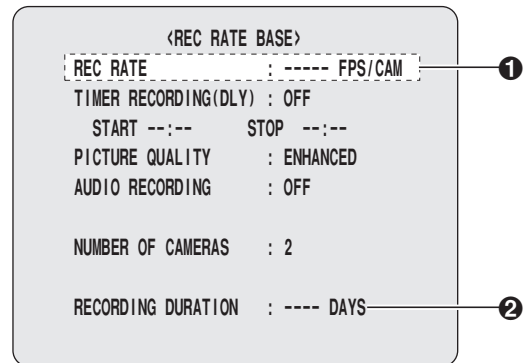

(Menu item - Description)

① RECORDING DURATION

1 to 99 can be selected. The default setting is 1.

② TIMER RECORDING (DLY)

The timer-controlled recording can be switched ON or OFF.

When "OFF" is set, the cursor does not move to the START time.

③ PICTURE QUALITY

Selections:

- BASIC (BA):** Rough image quality, approx. 15kB
- NORMAL (NO):** Standard image quality, approx. 22kB
- ENHANCED (EN):** Enhanced image quality, approx. 30kB
- FINE (FI):** Fine image quality, approx. 42kB
- SUPER FINE (SF):** Super fine image quality, approx. 50kB

④ AUDIO RECORDING

Audio recording can be switched ON or OFF. Audio recording can only be set if the recording rate is between 1~50 FPS. When the audio recording is "ON", the letter **A** will be displayed in front of the recording rate. Since both audio and video will be stored in the normal recording area, the number of images that can be recorded is reduced.

If the recording rate is out of the specified range, audio will not be recorded.

⑤ NUMBER OF CAMERAS

Displays the number of cameras connected to the DVR.

⑥ REC RATE

Displays the maximum recording rate per camera based on the other settings of this menu and the number of cameras. If a valid number cannot be calculated, "ERROR!" will be displayed.

Modify the settings to resolve the problem.

① REC RATE

Selections:

- 50, 25, 16.67, 12.5, 8.333, 6.25, 5, 4.167, 3.571, 3.125, 2.778, 2.5, 2.273, 1.923, 1.667, 1.471, 1.316, 1.190, 1.087, 1, 0.5, 0.333, 0.25, 0.2, 0.1, 0.05, 0.033

Audio recording can only be set when this setting is within the range of 50~1 FPS.

② RECORDING DURATION

Displays the maximum recording duration per camera based on the other settings of this menu and the number of cameras. If a valid number cannot be calculated, "ERROR!" will be displayed.

Modify the settings to resolve the problem.



The easy recording settings will be erased when the following occur:

- When the number of cameras detected by this DVR increases or decreases.
- Using the <ALARM REC MODE SET>, the pre-alarm recording is switched to "ON".
- Menu settings are loaded from a CompactFlash card.
- A different easy recording setting is performed.
- The normal recording settings or timer settings are modified.
- The recording areas of the hard disk are modified.
- When mirroring settings were changed under the hard disk settings.
- When the hard disk was changed.
- When a hard disk was added.

Recording settings

A-1 RECORDING DURATION BASE

Setting the recording based on duration

- 1 Display the <NORMAL REC EASY SET> screen as explained in "Displaying the recording settings screen" (P39).

The <NORMAL REC EASY SET> screen appears.

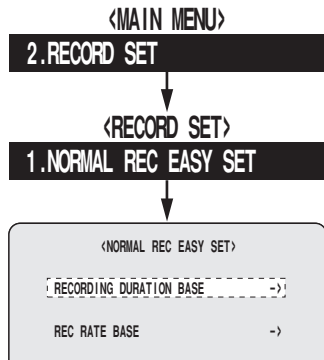
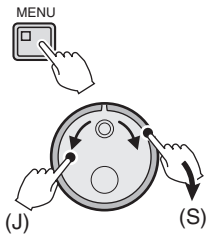

- 2 Turn the S-dial clockwise twice.

The <RECORDING DURATION BASE> screen is displayed, and the "1" at "RECORDING DURATION" is blinking.

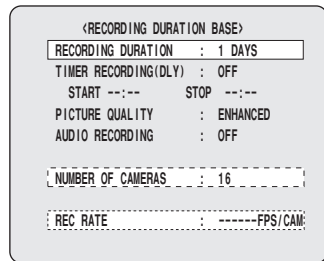
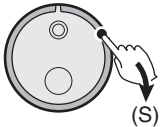

- 3 Turn the J-dial to select the RECORDING DURATION (example: 10), and then turn the S-dial clockwise.

The cursor moves to the "TIMER RECORDING (DLY)" field.

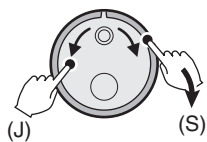

- 4 Set the timer.

Proceed to 5 if timer setting is not necessary.

- 1 Turn the S-dial clockwise. The "OFF" starts blinking.
- 2 Turn the J-dial to set TIMER RECORDING(DLY) to "ON", and then turn the S-dial clockwise. The cursor moves to the hour setting.



- 3 Turn the S-dial clockwise. The cursor moves to "START".
- 4 Turn the J-dial, select the hour (example: 09), and then turn the S-dial clockwise. The "00" indicator starts blinking.
- 5 Turn the J-dial, select the minutes (example: 30), and then turn the S-dial clockwise. Repeat the same procedure to enter the STOP time. The cursor moves to the PICTURE QUALITY "ENHANCED" field.

- 5 Turn the S-dial clockwise. Turn the J-dial, select the desired recording quality, and turn the S-dial clockwise.

The cursor moves to the "OFF" of the "AUDIO RECORDING" field.

- 6 Turn the S-dial clockwise. Turn the J-dial to switch AUDIO RECORDING "ON", and then turn the S-dial clockwise.

The cursor returns to "RECORDING DURATION".

- 7 Turn the S-dial counterclockwise.

The <WARNING> screen is displayed, and "NO" is blinking.

- Turn the J-dial, select "YES", and turn the S-dial clockwise.

Operation returns to the <NORMAL REC EASY SET> screen.

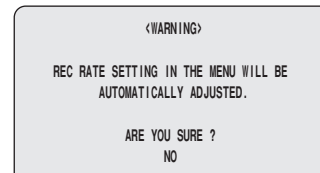

- 8 Press the EXIT/OSD button when the settings are complete.

The normal screen is displayed again.



Recording settings

A-2 REC RATE BASE

Set the recording based on recording rate

- 1 Display the <NORMAL REC EASY SET> screen as explained in "Displaying the recording settings screen" (P39).

The <NORMAL REC EASY SET> screen appears.

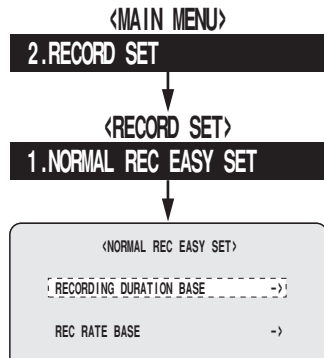
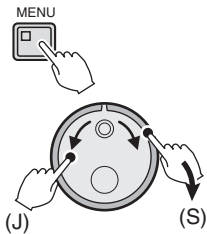

- 2 Turn the J-dial to select "REC RATE BASE", and then turn the S-dial twice clockwise.

The <REC RATE BASE> screen is displayed, and the number at REC RATE is blinking.

The rate varies according to the number of cameras connected to the DVR.

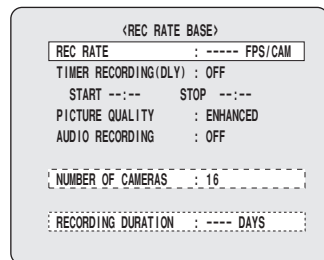
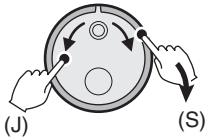

- 3 Turn the J-dial to select the REC RATE (example: 3.125), and then turn the S-dial clockwise.

The cursor moves to the "TIMER RECORDING (DLY)" field.

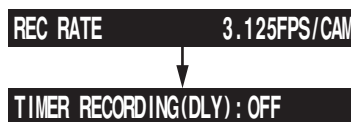
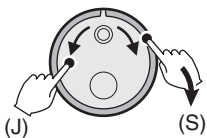

- 4 Set the timer.

Proceed to 5 if timer setting is not necessary.

- 1 Turn the S-dial clockwise.
The "OFF" starts blinking.
- 2 Turn the J-dial to set TIMER RECORDING(DLY) to "ON", and then turn the S-dial clockwise.
The cursor moves to the hour setting.



- 3 Turn the S-dial clockwise.
"00" of the start time starts blinking.
- 4 Turn the J-dial, select the hour (example: 09), and then turn the S-dial clockwise.
The "00" indicator starts blinking.
- 5 Turn the J-dial, select the minutes (example: 30), and then turn the S-dial clockwise.
Repeat the same procedure to enter the STOP time.
The cursor moves to the PICTURE QUALITY "ENHANCED" field.

- 5 Turn the S-dial clockwise. Turn the J-dial to select the desired recording quality, and then turn the S-dial clockwise.

The cursor moves to the AUDIO RECORDING "OFF" field.

- 6 Turn the S-dial clockwise. Turn the J-dial to select AUDIO RECORDING "ON", and then turn S-dial clockwise.

The cursor returns to "REC RATE".

- 7 Turn the S-dial counterclockwise.

The <WARNING> screen is displayed, and "NO" is blinking.

- Turn the J-dial, select "YES", and turn the S-dial clockwise.

Operation returns to the <NORMAL REC EASY SET> screen.

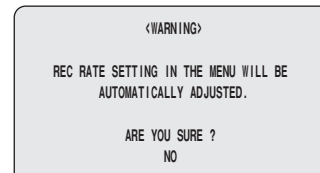

- 8 Press the EXIT/OSD button when the settings are complete.

The normal screen is displayed again.



Recording settings

B Recording area menu description

This screen is used to verify the total capacity of the hard disk, and the recording capacity of the individual recording areas. The recording areas can be modified as needed. Modifying the recording areas will result in initializing the hard disk, and all recordings to be erased. Save necessary images to some other media before modifying the recording areas.

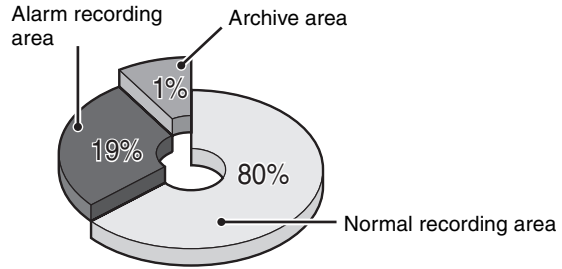
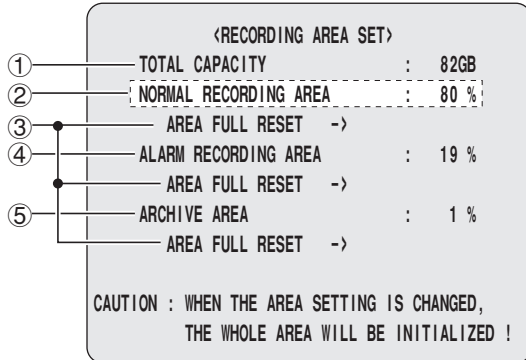

Hard disk recording areas

① Displays the total capacity of the internal hard disk of the DVR.

If the hard disk is replaced, the total capacity will change.

② Sets the recording capacity of the normal recording area. The default setting is 80%; it can be manually modified from 0% up to 99%.

If the normal recording area is set to 0%, video is only recorded in the alarm recording area.

③ Once the recording space of the hard disk becomes full, every time images are recorded on each of the recording areas, they are overwritten from the beginning.

④ Sets the recording capacity of the alarm recording area. The default setting is 19%; it can be manually modified from 0% up to 99%.

- A maximum of 16,000 alarm events can be recorded on one hard disk. Hard disk expansion allows for a maximum of 32,000 events. Note that the recording conditions will depend on the recording settings.

⑤ Sets the capacity of the archive area.

The default setting is 1%; the upper limit is 99%. This area cannot be set manually.

Verifying the capacity of the recording areas

1 Display the <RECORDING AREA SET> screen as explained in "Displaying the recording settings screen" (P39).

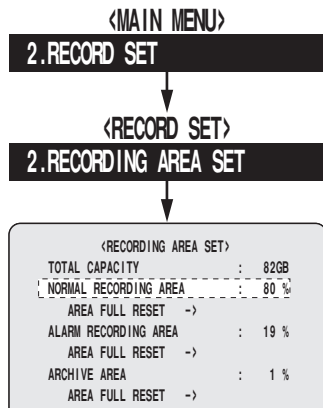
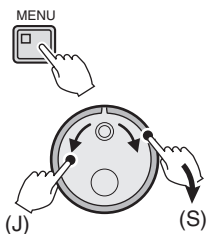

2 Press the EXIT/OSD button to end the setting procedure.



Recording settings

B-1 Changing the normal recording area and the alarm recording area

This operation will initialize the hard disk.

- 1 Display the <RECORDING AREA SET> screen as explained in "Displaying the recording settings screen" (P39).

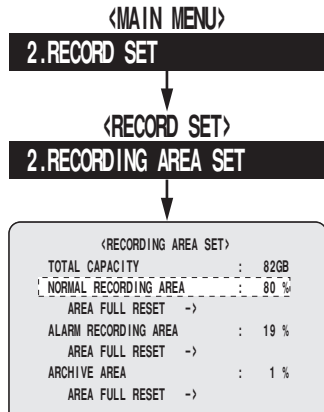
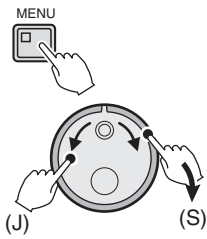

- 2 Turn the S-dial clockwise.
The "NORMAL RECORDING AREA : 80" starts blinking.
- 3 Turn the J-dial to set the "NORMAL RECORDING AREA" to 50% (example) and turn the S-dial twice clockwise.

The cursor moves to "ALARM RECORDING AREA" and the value starts blinking.



Note: The default setting in <RECORDING CONDITIONS SET> for the normal and alarm recording areas is "OVERWRITE: ON". Therefore, after setting the normal and alarm recording areas, the cursor will not move to "AREA FULL RESET". In order to use "AREA FULL RESET" for the normal and alarm areas, set the OVERWRITE setting to "OFF" under <RECORDING CONDITIONS SET>. (P47)

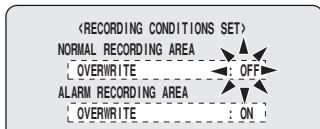

- 4 Turn the J-dial to set the "ALARM RECORDING AREA" (49% in the example), and turn the S-dial clockwise.

The cursor moves to "AREA FULL RESET" of the archive area settings.

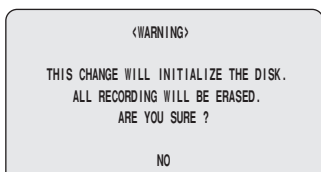

- 5 Turn the S-dial clockwise.
The <WARNING> screen is displayed, and "NO" is blinking.

- 6 Turn the J-dial, select "YES", and turn the S-dial clockwise.

The "HDD INITIALIZING!" message appears, and the initialization starts.

When the initialization is complete, the <RECORDING AREA SET> screen returns.

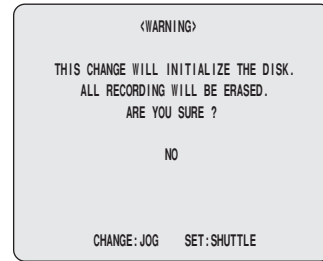

- 7 Press the EXIT/OSD button.



.....

■ To record over 16000 alarms

First, set the alarm recording area, then set the normal recording area to *0%. Regardless of the number of alarms, alarms are recorded until the set alarm recording area becomes full.

In the following cases, the hard disk will be initialized. Save the necessary video to a support media.

- **Normal recording area:** when 1% to 99% is set to *0%
when *0% is set to 0% to 99%
- **Alarm recording area, archive area:**
when the proportion is changed

When the normal recording area is set to *0% and recorded images are searched, it is possible to use only date/time search.

Recording settings

B-2 Archive area full reset

The archive area cannot be automatically overwritten.



Performing "AREA FULL RESET" will erase all images from the archive area.

- 1 Display the <RECORDING AREA SET> screen as explained in "Displaying the recording settings screen" (P39).

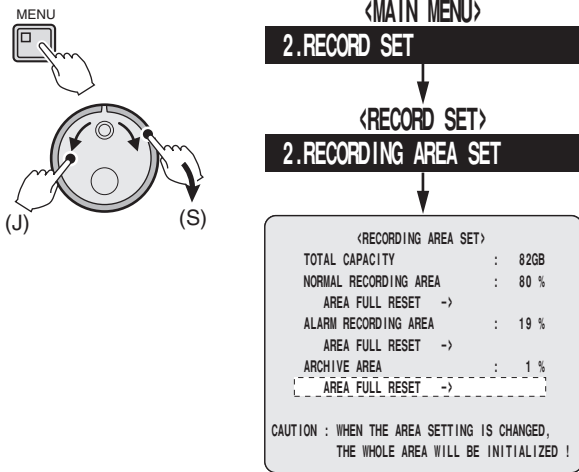

- 2 Turn the J-dial to select "AREA FULL RESET" of ARCHIVE AREA, and then turn the S-dial clockwise. The <WARNING> screen is displayed.
- 3 Turn the J-dial, select "YES", and turn the S-dial clockwise.



- 4 Press the EXIT/OSD button to end the setting procedure.



Recording settings

C Recording conditions menu description

This menu is used to set whether to continue recording and automatically overwrite data, or stop recording without overwriting the data when the normal recording area and the alarm recording area of the hard disk become full.

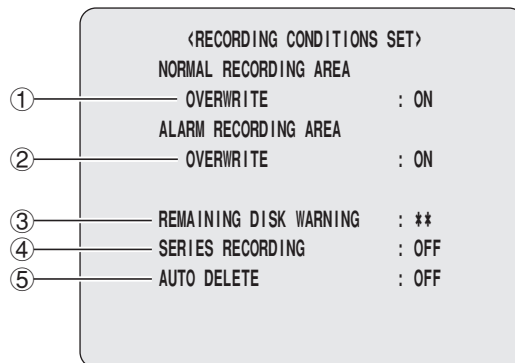

- ① **Selects the "OVERWRITE" setting for the normal recording area.**
ON: When the normal recording area becomes full, the new recordings will automatically overwrite existing video, starting with the oldest recordings.
OFF: When the normal recording area becomes full, automatically stop recording.

- ② **Selects the "OVERWRITE" setting for the alarm recording area.**
ON: When the alarm recording area becomes full, the new recordings will automatically overwrite existing video, starting with the oldest recordings.
OFF: When the alarm recording area becomes full, automatically stop recording.

- ③ **REMAINING DISK WARNING**
 Sets the **FULL** indicator or **ALARM FULL** indicator to blink when the remaining hard disk capacity drops below the specified volume.
 When "OVERWRITE" is turned "OFF" for the recording areas, the REMAINING DISK WARNING changes from "**" to "1%".
Selections: 1%, 2%, ... 9%, 10%

- ④ **SERIES RECORDING (P47)**
 If multiple hard disk recorders are connected, once the first hard disk becomes full the second disk can take over the recording. In the same way from the third disk on the recording is taken over in sequential order.

- ⑤ **AUTO DELETE (recording storage period)**
 Sets the storage period for video recorded in the normal and alarm recording areas. When the storage period has expired, the data will be automatically deleted.
 Save the necessary videos to the archive area or to a CompactFlash card.
Selections: OFF, 1, 2, 3 ... 98, 99 days

■ Remaining hard disk capacity warning (Monitor: Operation display)

When "OVERWRITE" is "OFF", the operation display will switch to show the remaining hard disk capacity.

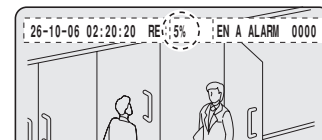

(DVR)

For example, if 5% is set, then when less than 5% of the hard disk capacity remains, the warning indicator (FULL) will start blinking. If there is no more capacity left, the indicator will change from blinking to continuously lit, and recording will stop.

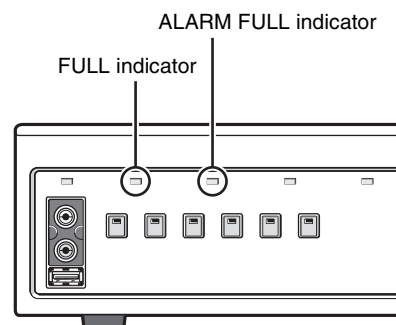

Recording settings

C-1 Overwrite setting for the recording areas

- 1 Display the <RECORDING CONDITIONS SET> screen as explained in "Displaying the recording settings screen" (P39).

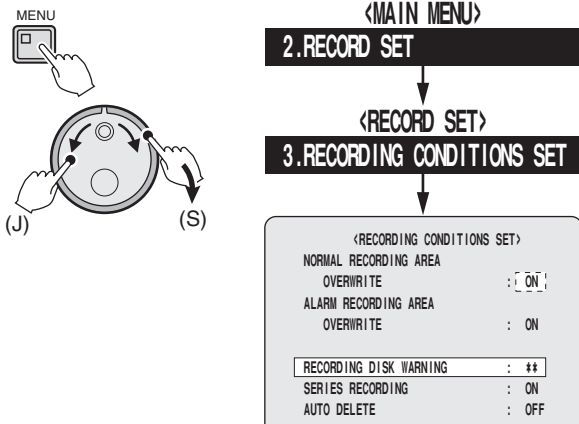

- 2 Turn the J-dial to select "OVERWRITE" for the normal or the alarm recording area, and then turn the S-dial clockwise.

- 3 Turn the J-dial, select "OFF", and turn the S-dial clockwise.

The "REMAINING DISK WARNING" changes from "**" to "1%", and disk overwrite is prohibited. If the available capacity in the normal or alarm recording area drops below 1%, the corresponding FULL indicator on the front panel of the DVR will start blinking.

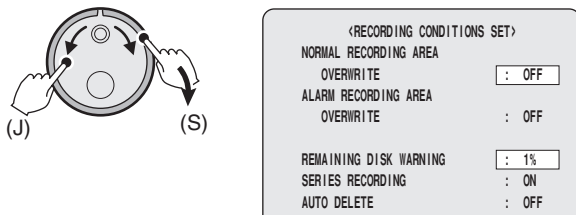

- 4 Changing the "REMAINING DISK WARNING" level

- 1 Turn the J-dial to select "REMAINING DISK WARNING", and then turn the S-dial clockwise.
- 2 Turn the J-dial to select remaining level (example: 5%), and then turn the S-dial clockwise. The cursor moves to "SERIES RECORDING".
Selections: 1%, 2%, ... 9%, 10%

- 5 Press the EXIT/OSD button to end the setting procedure.



C-2 Setting series recording

If multiple DVR units are connected, recording can be automatically continued on the next DVR when the recording area of the first one becomes full.

- 1 Connect the SERIES OUT terminal of the CONTROL terminal block on the rear panel of the first DVR to the SERIES IN terminal of the next DVR.

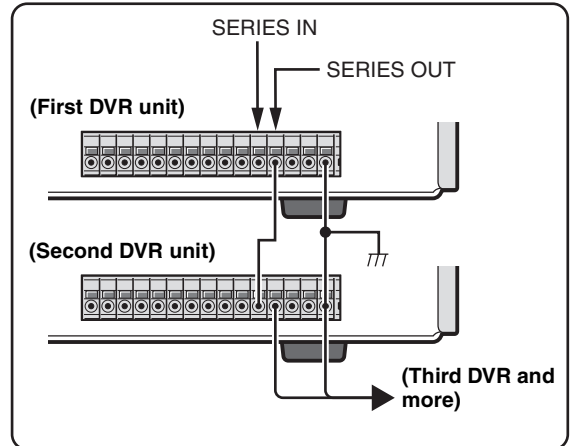

- Use cables no longer than 3m between the DVR units for serial connection.
- Connect the MIC terminal and the AUDIO terminal as shown below.

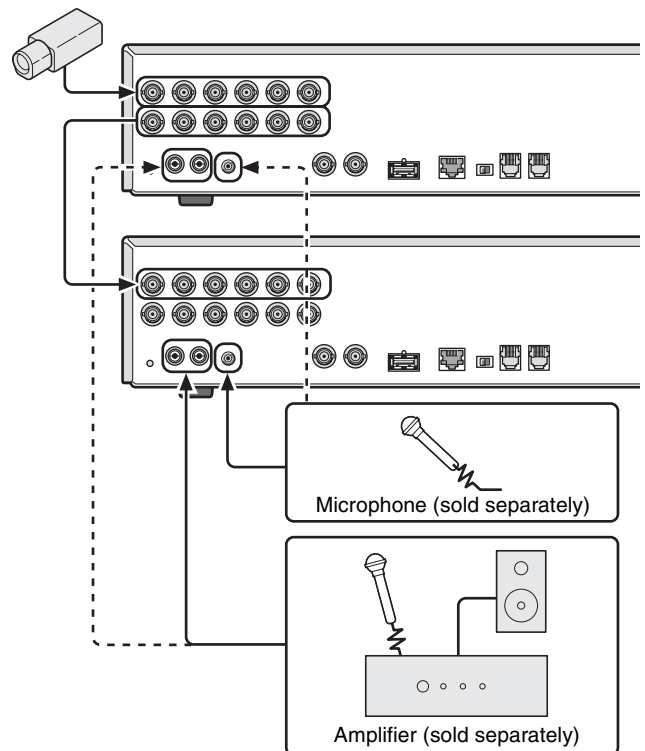

Recording settings

C-2 Setting series recording (continued)

- 2 Display the <RECORDING CONDITIONS SET> screen as explained in "Displaying the recording settings screen" (P39).

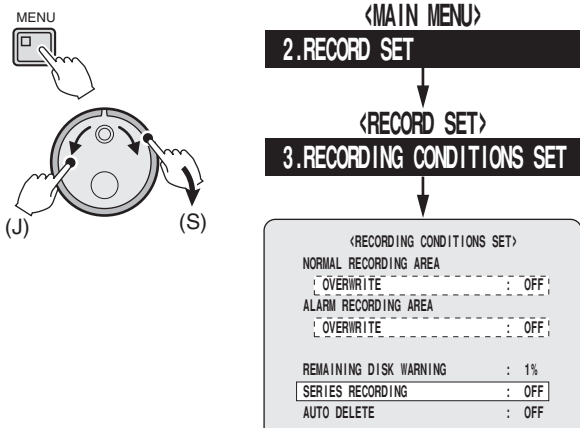

- 3 Turn the S-dial to select "OVERWRITE" under NORMAL RECORDING AREA. Turn the J-dial to select "OFF", and then turn the S-dial clockwise. Repeat the same procedure to set the OVERWRITE for the ALARM RECORDING AREA to "OFF".
- 4 Turn the J-dial to select "SERIES RECORDING", and then turn the S-dial clockwise. The cursor moves to "OFF".
- 5 Turn the J-dial, select "ON", and turn the S-dial clockwise.

SERIES RECORDING : ON

- 6 Press the EXIT/OSD button to return to the menu.
- 7 The series recording sets the following series recording. Press the EXIT/OSD button.

- Normal recording (P49)
- Timer-controlled recording (P51)
- Sets normal recording and combined alarm recording (P49, 55, 56)
- Sets timer-controlled recording and combined alarm recording (P51, 55, 56)



- Alarm recording cannot be used alone. Alarm recording must be used in combination with normal or timer-controlled recording.
- Normal recording and timer-controlled recording cannot be used simultaneously. If both are set at the same time, the timer-controlled recording will be disabled.

- 8 Copy the setting contents of the menu to media such as CompactFlash card as explained in the "COPY MENU SETTINGS" section (P79).
- 9 Copy the setting contents of the copied menu to DVR performing series recording (P79, 80). The DVR connected for series recording will have the same menu settings.

C-3 Series recording

- 1 Start recording on the first DVR.
 - Press the REC/STOP button if using normal recording or normal recording combined with alarm recording.
 - Press the TIMER button if using timer-controlled recording or timer-controlled recording combined with alarm recording.

- 2 If the normal or alarm recording area of the first DVR is insufficient, the recording will stop and it will automatically start on the hard disk of the next connected DVR.

- 3 Stop the recording.
 - Press the REC/STOP button for approximately 3 seconds if using normal recording or normal recording combined with alarm recording.
 - Press the TIMER button if using timer-controlled recording or timer-controlled recording combined with alarm recording.



When the SERIES OUT terminal of the last DVR is connected to the SERIES IN terminal of the first DVR and series recording is used, the normal and the alarm recording areas will be automatically overwritten. Save important videos before recording.

C-4 Setting the storage period for videos recorded in the recording areas

The archive area is not subject to storage expiration; archived videos will not be erased. When the storage period expires, video stored in the normal and alarm recording areas will be automatically erased.

- 1 Turn the J-dial to select "AUTO DELETE", and then turn the S-dial clockwise. The cursor moves to "OFF".
- 2 Turn the J-dial to select the storage period (example: 10), and then turn the S-dial clockwise.

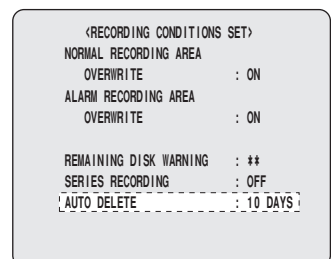
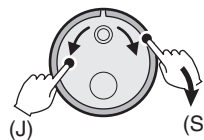

- 3 Press the EXIT/OSD button to end the setting procedure.



Recording settings

D Normal recording area menu description

This menu is used to set the picture quality, audio recording and recording rate for the normal recording area. A program number can be selected at the programmed recording settings to use the recording rate set for that program. (P50)

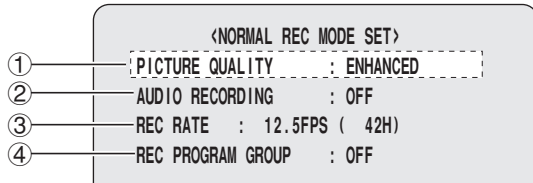

① PICTURE QUALITY

Selects the picture quality used to record video in the normal recording area. The recording duration will change according to the selected picture quality.

Selections:

- BASIC:** Rough image quality (BA)/15kB
- NORMAL:** Normal image quality (NO)/22kB
- ENHANCED:** Enhanced image quality (EN)/30kB
- FINE:** Fine image quality (FI)/42kB
- SUPER FINE:** Super fine image quality (SF)/50kB

② AUDIO RECORDING

- When the AUDIO RECORDING is set to "ON", the letter "A" will be displayed in front of the available recording rates (REC RATE). Audio recording is possible when the total recording rate of the cameras is within the range of A50~A1FPS.
- Audio will only be played when the playback speed is the same as the rate of recording. Video and audio may slightly be out of synch.

③ REC RATE

The recording rate is limited by the pre-alarm and mirroring settings. (P85)

Refer to the recording rate and duration time. (P83)

④ REC PROGRAM GROUP (P50)

This menu is used to specify the cameras to be used in each group (P-1~P-4) for programmed recording. After selecting the group, set the program for the group.

Selections: OFF/P-1/P-2/P-3/P-4

D-1 Normal recording area settings

- 1** Display the <NORMAL REC MODE SET> screen as explained in "Displaying the recording settings screen", and then turn the S-dial clockwise. (P39)
The PICTURE QUALITY "ENHANCED" starts blinking.

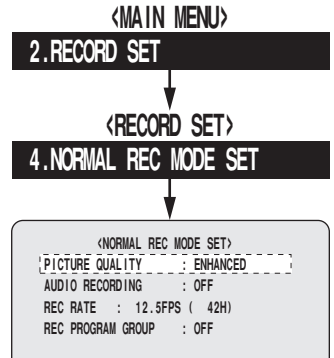
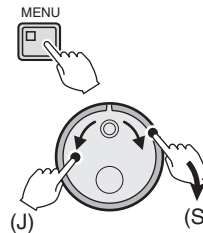

- 2** Turn the J-dial to select the desired PICTURE QUALITY (example: FINE), and then turn the S-dial twice clockwise.
The AUDIO RECORDING "OFF" field starts blinking.

- 3** Turn the J-dial to select the desired AUDIO RECORDING (example: ON), and then turn the S-dial twice clockwise.
The letter "A" is displayed indicating AUDIO RECORDING, and then the REC RATE starts blinking.

- 4** Turn the J-dial to select the desired REC RATE (example: 6.25), and then turn the S-dial twice clockwise.
The REC PROGRAM GROUP "OFF" starts blinking.

Turn the J-dial to select the desired REC PROGRAM GROUP (example: P-1), and then turn the S-dial clockwise.
REC RATE will be displayed as ***.

- 5** Press the EXIT/OSD button to end the setting procedure.



Recording settings

E Programmed recording menu description

This menu is used to set the desired cameras for each group (P-1, P-2, P-3 and P-4) for programmed recording. For each group, cameras are selected to enable or disable recording from them, and their individual recording rates are also set here.

After this setting is completed, the program number (P-1~P-4) can be selected for "REC PROGRAM GROUP" on the <NORMAL REC MODE SET> screen.

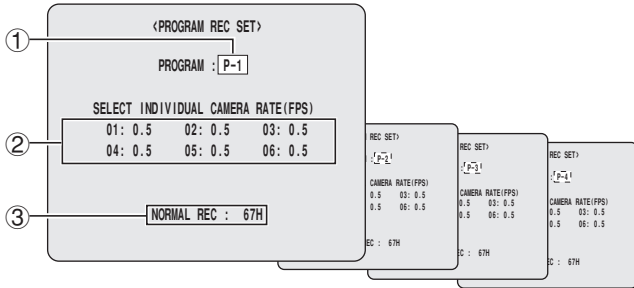

① PROGRAM number

Selects the program number.

Selections: P-1/P-2/P-3/P-4

② SELECT INDIVIDUAL CAMERA RATE (FPS)

Enables or disables cameras for recording, and sets their individual recording rates. The default setting for recording rate is 0.5.

Selections: 25/12.5/6.25/3.125/1.533/1/0.5/0.33/0.25/0.2/0.1/0.05/0.033FPS/OFF



The recording rate is limited by the pre-alarm and mirroring settings. (P85)

③ NORMAL REC

Displays the possible recording time for each group, based on the program settings.

E-1 Programmed recording settings

- 1 Display the <PROGRAM REC SET> screen as explained in "Displaying the recording settings screen", and then turn the S-dial clockwise. (P39)
The "P-1" starts blinking.

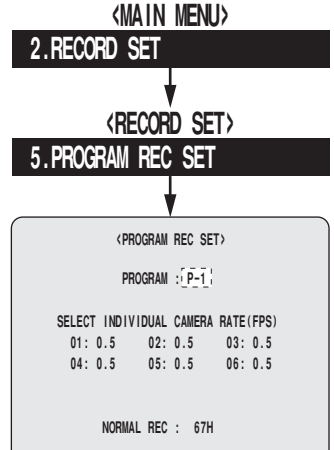
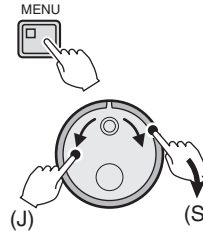

- 2 Turn the J-dial to select the desired PROGRAM number (example: P-2), and then turn the S-dial twice clockwise.

The "0.5" indicator starts blinking.

01: 0.5

- 3 Turn the J-dial to select the rate for "01" (example: 6.25), and then turn the S-dial clockwise.

- 4 Turn the J-dial, select "02", and turn the S-dial clockwise.

- 5 Turn the J-dial to select the rate (example: 12.5), and then turn the S-dial clockwise.

Repeat the same procedure to select the desired recording rates.

01: 6.25 02: 12.5 03: 0.5 04: 0.5

The possible recording time of the normal recording area is displayed, and the cursor moves to the program number.

- 6 Turn the J-dial to select other programs (P-2~P-4) and enable or disable recording from the individual cameras, and set their recording rates.

- 7 Press the EXIT/OSD button to end the setting procedure.



Recording settings

F Timer setting menu description

This menu is used to set the start and end times for timer-controlled recording.

The following timer functions are available:

①	②	③	④	⑤	⑥
WEEK	START	STOP	PROGRAM	FPS	SET
SUN	--:--	--:--	OFF	12.5 FPS	OFF
MON	--:--	--:--	OFF	12.5 FPS	OFF
TUE	--:--	--:--	OFF	12.5 FPS	OFF
WED	--:--	--:--	OFF	12.5 FPS	OFF
THU	--:--	--:--	OFF	12.5 FPS	OFF
FRI	--:--	--:--	OFF	12.5 FPS	OFF
SAT	--:--	--:--	OFF	12.5 FPS	OFF
DLY	--:--	--:--	OFF	12.5 FPS	OFF
EXT	*****	*****	OFF	12.5 FPS	OFF

F-1 Day of the week timer-controlled recording (same time and same recording rate every week for the specified day) (P52)

Sets the timer-controlled recording for the specific day of the week, selected from Sunday to Saturday.

F-2 Overlapping timer-controlled recording (P53)

Repeats the same timer-controlled recording every day.

F-3 External timer-controlled (alarm) recording (P54)

Records video when a signal is detected at the external timer terminal.

① WEEK

This column is used to select the day of the week for timer-controlled recording. When the name of the day starts blinking, it can be modified to a different day of the week.

The **SAT** and **DLY** rows, as shown at ⑦, are used when timer setting is required for a period longer than 24 hours.

Selections: SUN/MON/TUE/WED/THU/FRI/SAT/DLY

② START

This column is used to enter the start time of timer-controlled recording (24 hours time format).

③ STOP

This column is used to enter the stop time of timer-controlled recording (24 hours time format).

If the time period between the start and end time includes 12:00am (midnight), then the letter "T" will be displayed to the left of the end time setting.

④ PROGRAM

This column is used to set the program number (P-1~P-4) for programmed recording. (P50)

Selections: OFF/P-1/P-2/P-3/P-4

⑤ FPS (recording rate)

This column is used to modify the recording rate for the timer-controlled recording.

When using programmed recording, the recording rate will be pre-selected automatically. The recording rate cannot be input.

⑥ SET (ON/OFF)

This column is used to turn the timer ON or OFF.

⑦ SAT/DLY

These rows are used to set timer-controlled operation for a period longer than 24 hours.

⑧ EXT (external)

This row is used to set recording controlled by an external signal connected to the "EXT TIMER IN" terminal on the rear panel.

When the signal is detected (min. pulse width 1 sec), the recording of live video will start to the normal recording area.

■ Timer-controlled recording

- The settings for picture quality and audio recording will take their values from the settings performed under <NORMAL REC MODE SET>. (P49)
- If audio recording is performed, select the recording rate to 1 FPS or higher.

■ If the timer settings are overlapping

The priority order of recording is Day of the week reservation → Daily reservation → External input.

■ If the Day of the week and Daily settings are overlapping

Recording setting with the earlier start time will take priority. If the start time is the same, the one that is higher in the menu settings will take priority.

■ Cancelling timer-controlled operations

Press the MENU RESET button on the front panel while the timer setting menu is displayed.

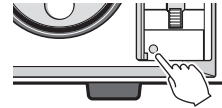

Recording settings

F-1 Day of the week timer-controlled recording (same time, same recording rate every week for the specified day)

1 Display the <TIMER SET> screen as explained in "Displaying the recording settings screen", and then turn the S-dial clockwise. (P39)
The "SUN" field starts blinking.

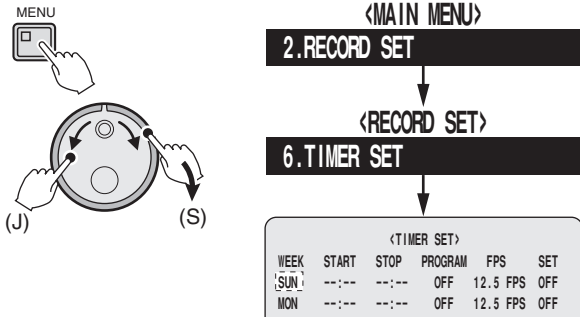

2 Set the timer-controlled recording.
Example:

DLY 08:30 18:30 OFF 1 FPS ON

- WEEK: Set daily (DLY).
- START: Set 8:30am.
- STOP: Set 6:30pm.
- FPS: Set 1 FPS.
- SET: Set to ON.

- 1 Turn the J-dial, change "SUN" to "DLY", and turn the S-dial clockwise.
The hour indicator "--" under START starts blinking.
- 2 Turn the J-dial, set "08", and turn the S-dial clockwise.
The minutes indicator "--" under START starts blinking.
- 3 Turn the J-dial, set "30", and turn the S-dial clockwise.
The hour indicator "--" under STOP starts blinking. Repeat the same procedure to perform the remaining settings in the example.
- 4 Turn the J-dial, select "ON" under SET, and turn the S-dial clockwise.
The cursor moves to the "MON" line.

WEEK	START	STOP	PROGRAM	FPS	SET
DLY	08:30	18:30	OFF	1 FPS	ON
MON	--:--	--:--	OFF	12.5 FPS	OFF
TUE	--:--	--:--	OFF	12.5 FPS	OFF

3 Press the EXIT/OSD button.



4 Press the TIMER button.
The TIMER indicator turns on, and the timer-controlled recording goes into standby mode.



- **When the start time set for timer-controlled recording comes**
The REC/STOP indicator turns on, "REC" appears in the operation display, and recording starts.



- **When the stop time set for timer-controlled recording comes**
The REC/STOP indicator turns off, the recording stops.
- **Stopping a timer-controlled recording in progress**
Press the TIMER button. The recording stops, the TIMER indicator turns off.
- **Playback during timer-controlled recording (P18)**

Setting a program for timer-controlled recording

Perform the following settings to set a program after setting the timer-controlled recording.

Example:

DLY 08:30 18:30 P-1 ** FPS ON**

- 1 Turn the J-dial to select the desired PROGRAM (P-1), and then turn the S-dial clockwise.
Since the program settings already include the recording rate, the FPS setting will show "****".
Selections: P-1, P-2, P-3, P-4
- 2 Turn the J-dial, select "ON" under SET, and turn the S-dial clockwise.
- 3 Press the EXIT/OSD button.



Recording settings

F-2 Overlapping timer-controlled recording

1 Display the <TIMER SET> screen as explained in "Displaying the recording settings screen". (P39)

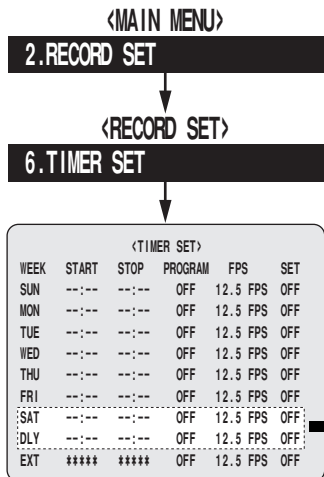
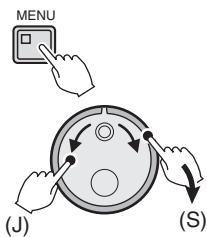

2 Set the timer-controlled recording.
Example:



- WEEK (start): Set MON.
- WEEK (stop): Set WED.
- START: Set 10:30am.
- STOP: Set 8:30pm.
- PROGRAM: Do not set.
- FPS: Set 5 FPS.
- SET: Set ON.

- 1 Turn the J-dial, select "SAT", and then turn the S-dial clockwise.
- 2 Turn the J-dial, change "SAT" to "MON", and turn the S-dial clockwise.
The hour indicator "--" under START starts blinking.
- 3 Turn the J-dial, select "10", and turn the S-dial clockwise.
The minutes indicator "--" under START starts blinking.
- 4 Turn the J-dial, select "30", and turn the S-dial clockwise.
The hour indicator "--" under STOP starts blinking.
- 5 Turn the J-dial, select "**", and turn the S-dial clockwise.
All fields after STOP will display "**", and will not take any input.
The "DLY" line automatically switches to "TUE".
- 6 Turn the J-dial, select "WED", and turn the S-dial clockwise.
The hour indicator "--" under STOP starts blinking.
- 7 Turn the J-dial, select "20", and turn the S-dial clockwise.
Repeat the same procedure to perform the remaining settings in the example.

3 Press the EXIT/OSD button.



4 Press the TIMER button.

The TIMER indicator turns on, and the timer-controlled recording goes into standby mode.



- **When the start time set for timer-controlled recording comes**

The REC/STOP indicator turns on, "REC" appears in the operation display, and recording starts.



- **When the stop time set for timer-controlled recording comes**

The REC/STOP indicator turns off, the recording stops.

- **Stopping a timer-controlled recording in progress**

Press the TIMER button. The recording stops, the TIMER indicator turns off.

- **Playback during timer-controlled recording (P18)**

■ Setting a program for timer-controlled recording

Perform the following settings to set a program after setting the timer-controlled recording.

Example:



1 Turn the J-dial to select the desired PROGRAM (P-1), and then turn the S-dial clockwise.

Since the program settings already include the recording rate, the FPS setting will show "****".

Selections: P-1, P-2, P-3, P-4

2 Turn the J-dial, select "ON" under SET, and turn the S-dial clockwise.

3 Press the EXIT/OSD button.



Recording settings

F-3 External timer-controlled (alarm) recording

1 Connect an external timer device to the EXT TIMER IN terminal on the rear panel (Figure 1).

2 Display the <TIMER SET> screen as explained in "Displaying the recording settings screen". (P39)

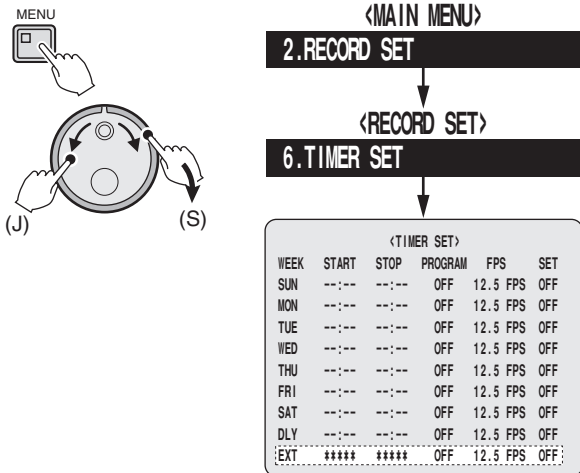

3 Set the timer-controlled recording.
Example:

EXT ** * OFF 5 FPS ON**

- PROGRAM: Do not set (OFF).
- FPS: Set 5 FPS.
- SET: Set ON.

- 1** Turn the J-dial to select "EXT", and then turn the S-dial twice clockwise.
The "12.5" under FPS starts blinking.
- 2** Turn the J-dial, select "5", and turn the S-dial clockwise.
The "OFF" indicator under SET starts blinking.
- 3** Turn the J-dial, select "ON", and turn the S-dial clockwise.

4 Press the EXIT/OSD button.



5 Press the TIMER button.

The TIMER indicator turns on, and the timer-controlled recording goes into standby mode.



- **Stopping a timer-controlled recording in progress**
Press the TIMER button. The recording stops, the TIMER indicator turns off.
- **Playback during timer-controlled recording (P18)**

Setting a program for timer-controlled recording

Perform the following settings to set a program after setting the timer-controlled recording.

Example:

EXT ** * P-1 *** FPS ON**

1 Turn the J-dial to select the desired PROGRAM (P-1), and then turn the S-dial clockwise.

Since the program settings already include the recording rate, the FPS setting will show "****".

Selections: P-1/P-2/P-3/P-4

2 Turn the J-dial, select "ON" under SET, and turn the S-dial clockwise.

3 Press the EXIT/OSD button.



Figure 1

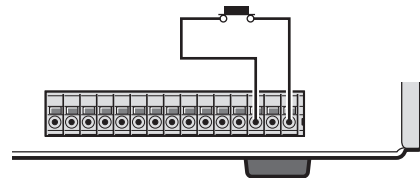

Recording settings

G Alarm recording settings menu description

The following settings can be performed under the alarm recording settings.

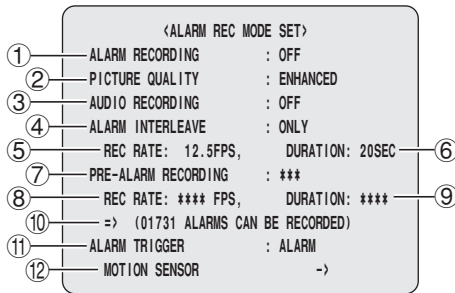

G-1 Alarm recording (P56)

These settings control the picture quality, audio recording and recording rate for the alarm recording area, when an alarm is detected.

G-2 Pre-alarm recording (P57)

These settings control the recording rate and the duration for pre-alarm recording.

G-3 Alarm trigger (P57)

Selects the alarm detection method.

G-4 Motion sensor (P58)

1 ALARM RECORDING

Turns alarm recording ON or OFF, and whether alarm recording should be performed during timer-controlled recording. When "OFF" is selected, no other settings can be set.

Selections:

OFF: Alarm recording is not performed.

ENABLED:

Alarm recording is performed, regardless of timer-controlled settings.

AL-REC ON TIMER:

Alarm recording is performed only during timer-controlled recording.

AL-REC OFF TIMER:

Alarm recording is performed only when timer-controlled recording is not.

ONLY AL-RC ON TMR:

Alarm recording is performed only during the period specified by the timer setting. If this setting is selected, timer-controlled recording, and the TIMER button will be disabled.

2 PICTURE QUALITY

Select the picture quality of the recordings.

Selections:

BASIC/NORMAL/ENHANCED/FINE/SUPER FINE

3 AUDIO RECORDING

Audio recording can be switched ON or OFF.

Audio recording can only be set if the recording rate is in the range of 25~1 FPS. When audio recording is selected, an "A" is displayed in front of the recording rate. Since both audio and video will be stored in the alarm recording area, the number of images that can be recorded is reduced.

If the recording rate is out of this range, audio recording will not be performed; even if audio recording was set.

4 ALARM INTERLEAVE (recording pattern)

Selections:

ONLY: Records only the live video where the alarm occurred.

SW: Alternately records the live video from the camera where the alarm occurred and the live video from all connected cameras.

5 REC RATE

The following settings can be selected:

Selections:

25, 16.67, 12.5, 8.333, 6.25, 5, 4.167, 3.571, 3.125, 2.778, 2.5, 2.273, 1.923, 1.667, 1.471, 1.316, 1.19, 1.087, 1, 0.5, 0.333, 0.25, 0.2, 0.1, 0.05, 0.033

Audio recording can only be set when this setting is within the range of 25~1 FPS.

6 DURATION

Selects the recording duration for a single alarm event from the following selections:

5SEC/10/20/40/1MIN/2/3/4/5/10/15/CC

CC: Recording is performed as long as the alarm is present (minimum 5 sec).

7 PRE-ALARM RECORDING

OFF: Pre-alarm recording is not performed.

ON: Pre-alarm recording is performed.

8 REC RATE

Refer to the pre-alarm recording time under recording rate settings. (P85)

9 DURATION

Refer to pre-alarm recording time. (P85)

10 ALARMS CAN BE RECORDED (number of alarms that can be recorded)

11 ALARM TRIGGER

Selects the alarm detection method from the followings:

Selections:

ALARM:

Performs alarm recording when an external alarm is detected.

SENSOR:

Performs alarm recording when a motion sensor detects movement. (P59)

ALARM AND SENSOR:

Performs alarm recording when an external alarm and a motion sensor alarm are detected simultaneously.

ALARM OR SENSOR:

Performs alarm recording when either an external alarm or a motion sensor alarm is detected.

12 MOTION SENSOR

Displays the motion sensor setting screen.

Recording settings

G-1 Alarm recording settings

- 1 Display the <ALARM REC MODE SET> screen as explained in "Displaying the recording settings screen", and then turn the S-dial clockwise. (P39)

The "OFF" field of ALARM RECORDING starts blinking.

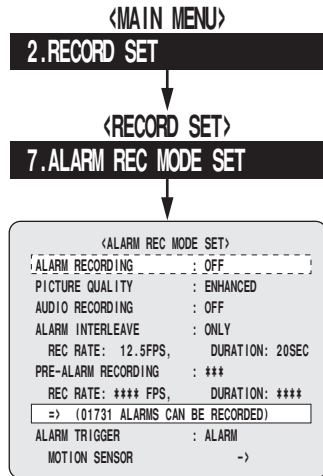
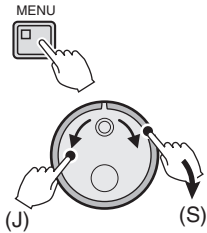

- 2 Set the alarm recording.

- 1 Turn the J-dial to select **ALARM RECORDING** selection, and then turn the S-dial twice clockwise.
Selections: OFF/ENABLED/AL-REC ON TIMER/AL-REC OFF TIMER/OLY AL-RC ON TMR

- 2 Turn the J-dial to select the desired **PICTURE QUALITY**, and then turn the S-dial twice clockwise.
After the arrow symbol (=>) the number of alarms that can be recorded is displayed.
Selections: BASIC/NORMAL/ENHANCED/FINE/SUPER FINE

Example:

=> (01387 ALARMS CAN BE RECORDED)

- 3 Turn the J-dial to switch **AUDIO RECORDING "ON"**, and then turn the S-dial twice clockwise.
The letter "A" is displayed in front of the recording rate, and the number of alarms that can be recorded is displayed after the "=>" symbol.

Example:

REC RATE: A 12.5FPS, DURATION: 20SEC

=> (01431 ALARMS CAN BE RECORDED)

- 4 Turn the J-dial to select the recording pattern (**ALARM INTERLEAVE**), and then turn the S-dial twice clockwise.
Selections: ONLY/SW

If ONLY is selected (Figure 1):

Live video will be recorded only from the camera where the alarm was detected, until the alarm is cancelled.

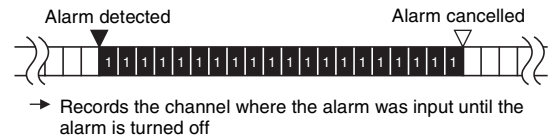

If SW is selected (Figure 2):

Live video will be recorded alternately from the camera where the alarm occurred and from all connected cameras.

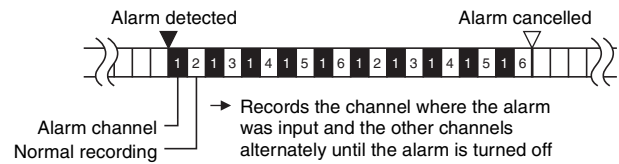

- 5 Turn the J-dial to select the **REC RATE** (example: 5), and then turn the S-dial clockwise.
Repeat the same procedure to set the DURATION.

- 3 Press the **EXIT/OSD** button.

The normal screen is displayed again.

- The letter "ALARM" and the number of alarm recordings are displayed in the operation display.
- When an alarm is detected, the "ALARM" field starts blinking.

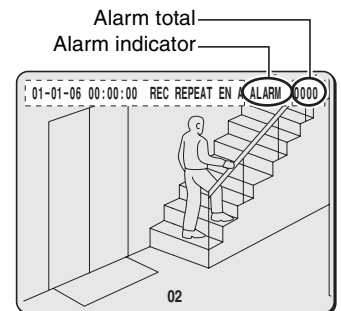

- If consecutive alarms are detected on the same channel within the duration of the recording, depending on the alarm retrigger setting, they may be counted as one alarm. (P60)

Recording settings

G-2 Pre-alarm recording settings

- 1 Display the <ALARM REC MODE SET> screen as explained in "Displaying the recording settings screen", and then turn the S-dial clockwise. (P39)
The "OFF" field of ALARM RECORDING starts blinking.

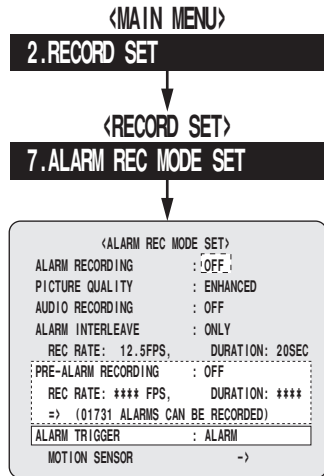
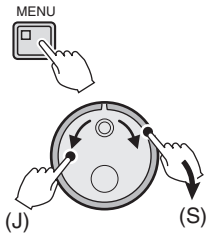

- 2 Set the pre-alarm recording.

- 1 Turn the J-dial to select "ENABLED" for ALARM RECORDING, and then turn the S-dial clockwise.
The "***" field of the PRE-ALARM RECORDING switches to "OFF".

PRE-ALARM RECORDING : OFF

- 2 Turn the J-dial to select "PRE-ALARM RECORDING", and then turn the S-dial clockwise.
The "OFF" indicator of PRE-ALARM RECORDING starts blinking.
- 3 Turn the J-dial, turn "ON" the PRE-ALARM RECORDING, and then turn the S-dial clockwise.
The "****" displayed at the REC RATE and DURATION fields changes to numbers, and a <WARNING> screen is displayed, with "NO" blinking.

REC RATE: A 12.5FPS, DURATION: 1MIN

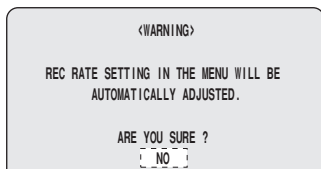

- 4 Turn the J-dial, select "YES", and turn the S-dial clockwise.
The cursor moves to "REC RATE".
- 5 Turn the S-dial clockwise.

- 6 Turn the J-dial to select the REC RATE (example: 8.333), and then turn the S-dial clockwise.
Repeat the same procedure to set the DURATION (example: 20SEC).
After the arrow symbol (=>) the number of alarms that can be recorded is displayed.

REC RATE: A 8.333FPS, DURATION: 20SEC

=> (00694 ALARMS CAN BE RECORDED)

- 3 Press the EXIT/OSD button.
"PRE" appears in the operation display area.
When an alarm is detected, the "ALARM" field starts blinking.

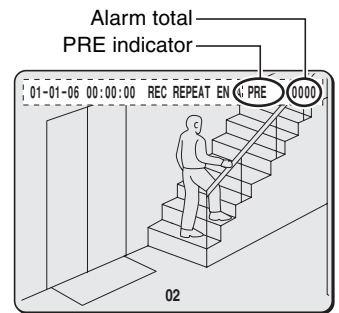

G-3 Alarm trigger setting

- 1 Turn the J-dial to select ALARM TRIGGER selections and turn the S-dial clockwise.
The "ALARM" starts blinking.
Selections:
ALARM/SENSOR/ALARM AND SENSOR/ALARM OR SENSOR

ALARM TRIGGER : ALARM

- 2 Turn the J-dial, select "ALARM". Then turn the S-dial clockwise.
The cursor moves back to the ALARM RECORDING field.

- 3 Press the EXIT/OSD button.



Input signals used as external alarms

The signals that can be used as alarms are of two types: signals detected at the ALARM IN terminal switches, and alarm signals superimposed on the coaxial signals coming from cameras.

Recording settings

G-4 Motion sensor screen description

Use this screen for motion sensor setting on a live video screen to detect moving objects such as intruders, and generate alarms.

The motion sensor detects movement based on intensity-changes on the screen. It is necessary to use sensor settings that are appropriate for both the location of the sensor and for the observed objects.

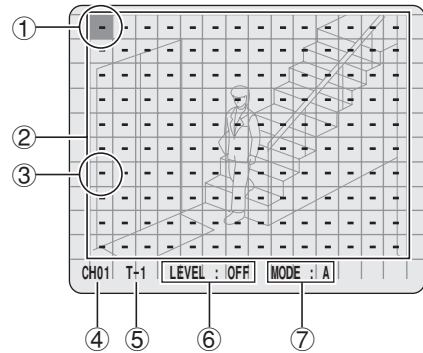

① Cursor

The default location of the cursor is the upper left corner. Use the J-dial to move it horizontally.

② Sensor setting range

The motion sensor can be set within this area.

③ Motion sensor

The type of sensor can be selected according to the detection location. Use the J-dial to change the type of the sensor.

—: Sensor turned off

A: Sensor A is used for detection

B: Sensor B is used for detection

④ Camera number display (CH01)

Selects the camera number for the motion sensor.

Use the camera selection buttons to change the camera number.

Selections: CH01/CH02/CH03/CH04/CH05/CH06

⑤ Time period (T-1)

This DVR has two timers (A and B) for setting time periods in two blocks, and separate sensors can be set up for each period.

Refer to the section about setting the time periods. (P37)

Selections: T-1/T-2/T-3/T-4

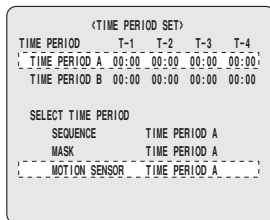

⑥ LEVEL

Sets the sensitivity of the motion sensor.

OFF: Sensitivity is not set.

1 (High sensitivity) ~ 10:

Selects the sensitivity as a numeric value.

☞ Motion sensor sensitivity check

When the sensor detects movement, the green (■) symbol changes to red, and a buzzer (beeper) goes off.

If the sensitivity is set high, a slight change in the lighting may trigger the sensor. Set the sensitivity appropriate for the setting location.

☞ Stopping the motion sensor recording

Display the <ALARM REC MODE SET> screen while recording is in progress, and turn the S-dial clockwise. The motion sensor screen appears. Press the camera selection button of the current camera, and set LEVEL "OFF".

⑦ MODE

Sets the detection method of the motion sensor.

Selections:

A: Detects moving objects at the location.

B: Detects moving objects at the location.

A AND B:

Detects simultaneous movement of objects at location A and B.

A AND NB:

Setting the moving objects detection to A and the non-moving objects detection to B will ensure that only A detects moving objects so that the detectors do not respond to such changes as light changes detected simultaneously.

A TO B:

Detects objects moving from location A to location B (time from A to B is within 2 seconds).

B TO A:

Detects objects moving from location B to location A (time from B to A is within 2 seconds).

C: Detects when the intensity on the entire screen becomes even (for example vandals spray-painting the camera). There is no need to set a location for the sensor.

Recording settings

G-5 Motion sensor setting

1 Set "TIME PERIOD A" and "TIME PERIOD B" using <TIME PERIOD SET> (P37).

2 Display the <ALARM REC MODE SET> screen as explained in "Displaying the recording settings screen", and then turn the S-dial clockwise. (P39)

The "OFF" field of ALARM RECORDING starts blinking.

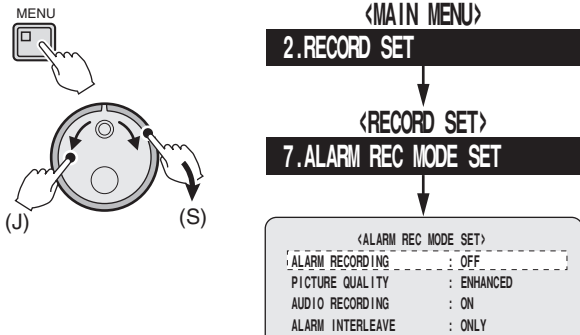

3 Display the motion sensor screen

① Turn the J-dial to select "ENABLED" for ALARM RECORDING, and then turn the S-dial clockwise.

② Turn the J-dial, select ALARM TRIGGER, and turn the S-dial clockwise.

Selections:

ALARM/SENSOR/ALARM AND SENSOR/ALARM OR SENSOR

③ Turn the J-dial to select "SENSOR", and then turn the S-dial twice clockwise.

The motion sensor screen is displayed.

4 Set the SENSOR.

Example:

- Camera number selection: Channel 3 (CH03)
- Time period A: T-1
- LEVEL: 2
- MODE (detection method): A AND B

① Press camera selection button 3.

The channel display changes to "CH03".

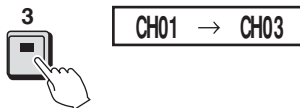

② Turn the J-dial to move the cursor to the desired sensor location, and then turn the S-dial clockwise.

③ Turn the J-dial, set the sensor to "A", and turn the S-dial clockwise.

When "A" is accepted, the cursor moves to the right, to the next position.

Repeat the procedure to move the cursor, and set the sensor for A and B.



④ Turn the J-dial to move the cursor to the time period selection "T-1", and then turn the S-dial clockwise.

The "T-1" indicator starts blinking.

⑤ Turn the J-dial to select "T-2", and then turn the S-dial twice clockwise.

The "OFF" indicator of LEVEL starts blinking.

⑥ Turn the J-dial to select LEVEL to "2", and then turn the S-dial twice clockwise.

The "A" field of MODE starts blinking.

⑦ Turn the J-dial, select the "A AND B" for MODE, and then turn the S-dial clockwise.

When detection method is accepted, the cursor moves to the upper left position.

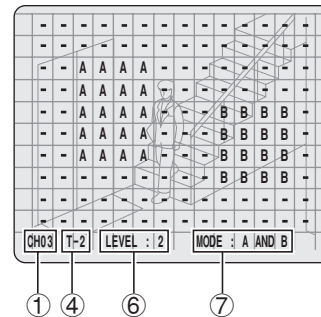

5 Set the following contents using the same procedure

- Channel number display
- Time period
- LEVEL
- MODE



The LEVEL and MODE settings can be different for the time periods (T-1, T-2, T-3 and T-4) of TIME PERIOD A, but the location of the motion sensor is fixed. The motion sensor cannot be set to different locations for the different time periods.

6 To exit, turn the S-dial counterclockwise.

Operation returns to the <ALARM REC MODE SET> screen.

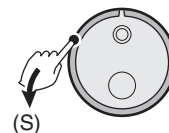

Recording settings

H Alarm operation settings menu description

This menu is used to extend the duration of the alarm recording and to set the display method when an alarm occurs.

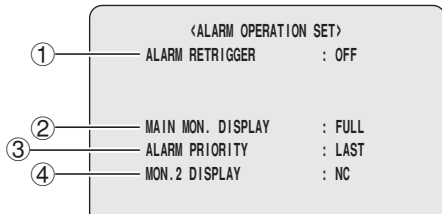

① ALARM RETRIGGER

This setting controls whether the recording duration will be extended when another alarm is detected on the same channel that is currently performing alarm recording.

When setting "ON"

- If a second alarm is detected during DURATION operation on the same channel the recording time is prolonged by the number of minutes set in DURATION from the point when the second alarm was detected.

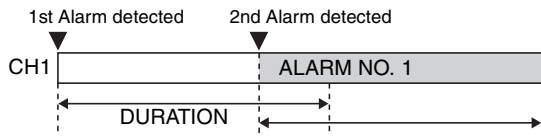

- If another channel detects a second alarm during DURATION operation and the same channel detects a third alarm the first alarm recording finishes when the third alarm is detected and the third alarm recording starts. If the alarm is detected on another channel (CH5), the recording takes place as set in DURATION.

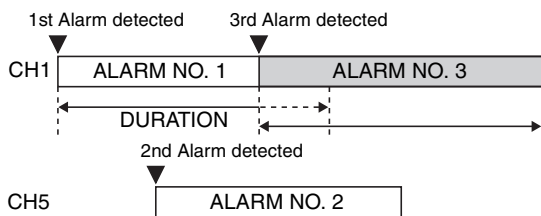

When setting "OFF"

- Within the set DURATION, alarms detected by the same channel are not acknowledged, therefore the recording stops at the end of the DURATION. However, the second alarm recording is recorded in the first alarm recording.

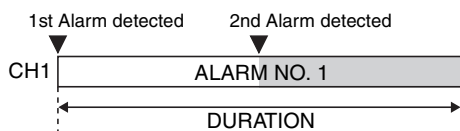

- If another channel detects a second alarm during DURATION operation and the same channel detects a third alarm, the first alarm recording finishes when the third alarm is detected and the third alarm recording starts. If another alarm is detected on another channel (CH5), the recording takes place as set in DURATION.

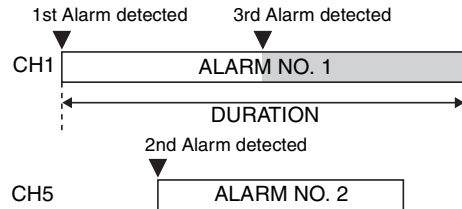

② MAIN MON. DISPLAY

Selects the screen type to use for display when an alarm is detected.

NC: The main monitor will not change, even if an alarm is detected.

FULL: When an alarm is detected, the main monitor will display the video from that channel in full-screen mode.

6: When an alarm is detected, the main monitor will change to multi-6 screen mode.

③ ALARM PRIORITY (display when multiple alarms are detected)

Sets the priority for alarm display to use when multiple alarms are overlapping.

LAST: When multiple alarms are overlapping, display is performed in the priority order. The most recent alarm is given first priority, then the one detected before that, and so on.

FIRST: When multiple alarms are overlapping, only the alarm detected first will be displayed. Alarms detected after that will not be displayed.

However, if the duration of the first alarm is over, alarms that have remaining durations will be displayed in the order of detection.

SWITCH: When multiple alarms are overlapping, the alarms will be displayed in a scrolling fashion, showing each alarm video for one second.

④ MON. 2 DISPLAY

Selects whether the monitor connected to the MON2 terminal will be used to display the alarm video.

NC: When an alarm is detected, the alarm video will not be displayed on monitor 2.

SWITCH: When multiple alarms are overlapping, the alarms will be displayed in a scrolling fashion, showing each alarm video for one second.

LAST: When multiple alarms are overlapping, display is performed in the priority order. The most recent alarm is given first priority, then the one detected before that, and so on.

FIRST: When multiple alarms are overlapping, only the alarm detected first will be displayed. Alarms detected after that will not be displayed.

However, if the duration of the first alarm is over, alarms that have remaining durations will be displayed in the order of detection.

Recording settings

H-1 Alarm operation settings

- 1 Display the <ALARM OPERATION SET> screen as explained in "Displaying the recording settings screen", and then turn the S-dial clockwise. (P39)
The "OFF" indicator of ALARM RETRIGGER starts blinking.

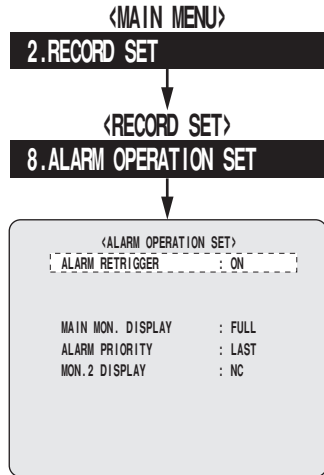
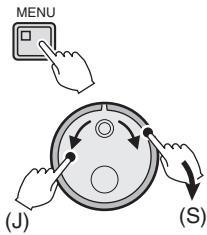

- 2 Turn the J-dial, select "ON" for ALARM RETRIGGER, and turn the S-dial clockwise.
The cursor moves to "MAIN MON. DISPLAY".
- 3 Press the EXIT/OSD button when the settings are complete.
Operation returns to the normal screen.



H-2 Alarm display settings

- 1 Turn the J-dial, select "MAIN MON. DISPLAY", and turn the S-dial clockwise.
The "FULL" indicator of MAIN MON. DISPLAY starts blinking.

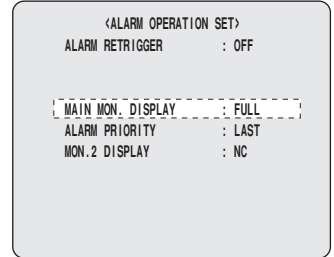
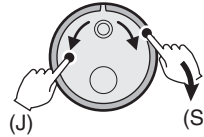

- 2 Turn the J-dial to select FULL (example), and then turn the S-dial twice clockwise.
Selections: FULL/6/NC
The "LAST" indicator of ALARM PRIORITY starts blinking.
- 3 Turn the J-dial to select "FIRST", and then turn the S-dial twice clockwise.
Selections: LAST/FIRST/SWITCH
The "NC" indicator of MON.2 DISPLAY starts blinking.
- 4 Turn the J-dial, select "LAST", and then turn the S-dial clockwise.
The cursor moves back to the ALARM RETRIGGER field.
Selections: NC/SWITCH/LAST/FIRST
- 5 Press the EXIT/OSD button when the settings are complete.
Operation returns to the normal screen.



Alarm cancellation

- **Forced cancellation of an alarm operation in progress**
Press the camera selection button of the channel with the alarm for about 3 seconds.
- **Cancellation by a switch when alarm is detected**
Install a switch between the ALARM RESET and the C (ground) terminal of the terminal block on the rear panel, and turn on the switch when an alarm is detected.

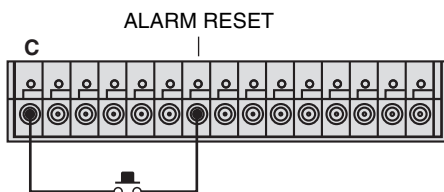

General settings

Menu configuration

■ Displaying the general settings screen

- 1** Press the MENU button and use the J-dial to select "3. GENERAL SET", and then turn the S-dial clockwise.
The <GENERAL SET> screen appears.

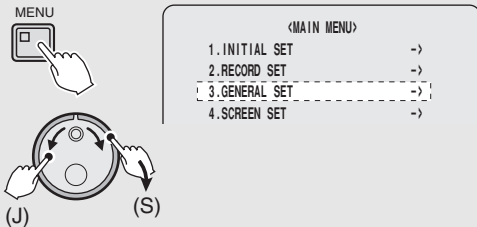

- 2** Turn the J-dial, select the desired submenu, and turn the S-dial clockwise.

The selected screen (A~C) is displayed. Refer to the appropriate pages for the settings.

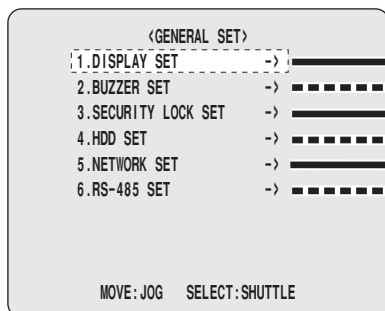
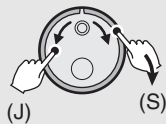

A Data display settings/VIDEO LOSS settings (P63)

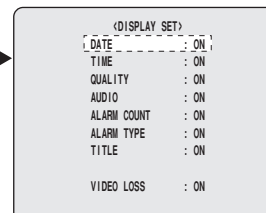

B Buzzer settings (P64)

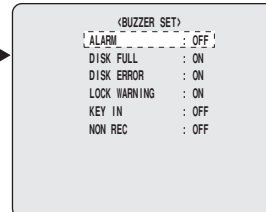

C Security lock settings (P65)



D Hard disk settings (P68)



E Network settings (P69)

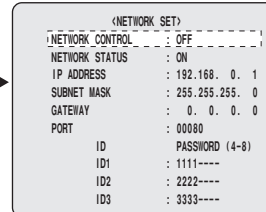

F RS-485 settings (P70)

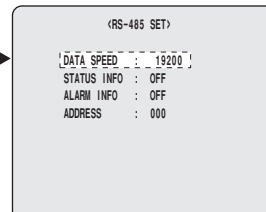

General settings

A Data display settings/VIDEO LOSS settings

These settings are used to control the operating display area of the monitor, to display the date, time and other information. Normally all indicators are displayed, but they can be hidden, if needed.

"VIDEO LOSS" can be set to be displayed when a camera video is interrupted due to an unexpected problem, or a lamp connected to the rear panel control terminals can be turned on.

- 1 Display the <DISPLAY SET> screen as explained in "Displaying the general settings screen", and then turn the S-dial clockwise. (P62)

The "ON" indicator on the DATE line starts blinking.

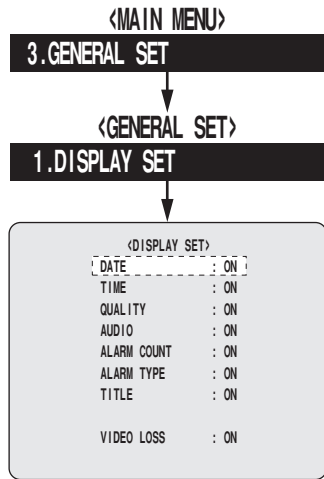
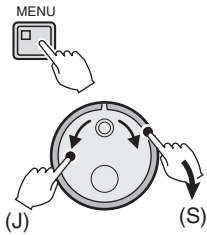

- 2 Turn the J-dial, set the DATE to "OFF", and then turn the S-dial clockwise.

Repeat the same procedure for each item you want to hide from the display.

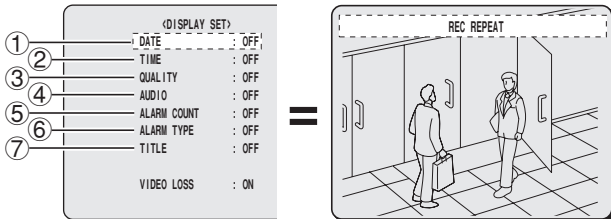

■ The operating display area after setting the items "ON".

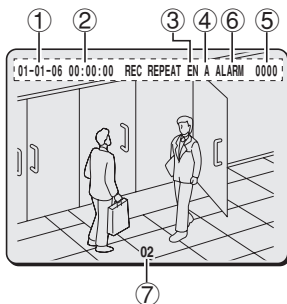

- 3 Turn the J-dial, select "VIDEO LOSS", and turn the S-dial clockwise.

The "ON" field starts blinking.

Normally this is set to display. If necessary, turn the J-dial and hide it by setting it to "OFF".

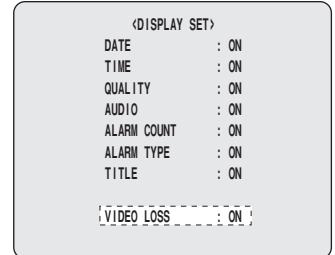
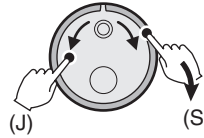

- 4 Turn the S-dial clockwise.

- 5 Press the EXIT/OSD button.



☞ Cancelling the VIDEO LOSS detection

- Connect a normal video signal.
- If video signal connection is not necessary, then press the camera selection button where the VIDEO LOSS was detected, and then press the same camera selection button again for about 3 seconds.

General settings

B Buzzer settings

These settings are used to generate a warning buzzer when the hard disk is full and at alarm events.

- 1 Display the <BUZZER SET> screen as explained in "Displaying the general settings screen", and then turn the S-dial clockwise. (P62)

The "OFF" field in the ALARM line starts blinking.

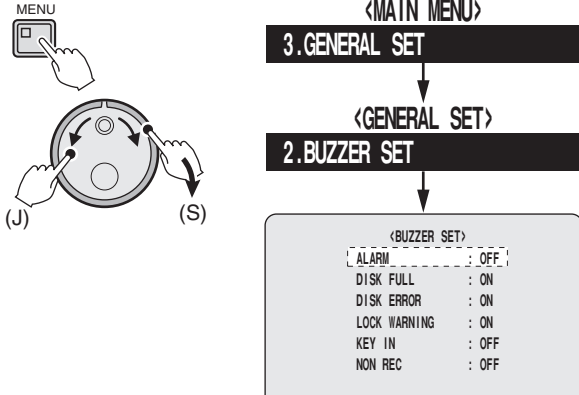

- 2 Turn the J-dial to select ON or OFF, and then turn the S-dial clockwise.

Repeat the same procedure for selecting the desired settings for each item.

- **ALARM**
 - OFF:** Buzzer will not sound, even if an alarm is detected.
 - ON:** Buzzer will sound when an alarm is detected.
- **DISK FULL**
 - OFF:** The buzzer will not sound, even if the hard disk is full, and overwrite is disabled.
 - ON:** The buzzer will sound if the hard disk is full, and overwrite is disabled.
- **DISK ERROR**
 - OFF:** The buzzer will not sound, even if a hard disk error occurred.
 - ON:** The buzzer will sound if a hard disk error occurred.
- **LOCK WARNING**
 - OFF:** The buzzer will not sound, even if the button locked by the security lock is pressed.
 - ON:** The buzzer will sound twice with a 0.5 sec cycle if the button locked by the security lock is pressed.
- **KEY IN**
 - OFF:** The buzzer will not sound, even if the button necessary for operation is pressed.
 - ON:** The buzzer will sound, when the button necessary for operation is pressed.
- **NON REC**
 - OFF:** The buzzer will not sound, even if recording was stopped.
 - ON:** The buzzer will sound if the recording was stopped.

- 3 Press the EXIT/OSD button.



- Press any operating button to stop the buzzer.

The buzzer can also be stopped by turning the S-dial or the J-dial.

General settings

C Security lock menu description

This menu is used to set passwords and to limit access to the DVR. There are two passwords, one for the administrator, and one for the user.

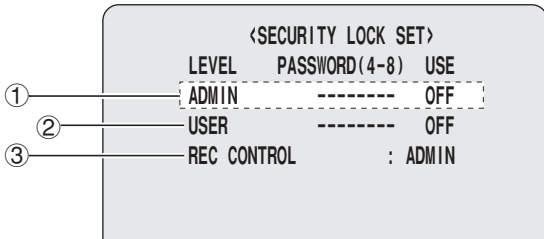

1 ADMIN

This item is used to enter the administrator's password (numerals 0, 1~9 and the letters A~Z can be used for passwords). The ON/OFF setting enables or disables the security lock.

- The password must be between 4~8 characters long. If the password entered is shorter than 3 characters, the password will be erased, and a new entry will be required.
- If the "OFF" setting is selected, that means the security lock will not be used, therefore the USER field will be disabled and the user password cannot be entered.
- If the administrator password is set, and correctly entered, all operations will be accessible.

2 USER

This item is used to enter the user's password (numerals 0, 1~9 and the letters A~Z can be used for passwords). The ON/OFF setting in the USE column enables or disables the security lock.

- The password must be between 4~8 characters long. If the password entered is shorter than 3 characters, the password will be erased, and a new entry is required.

3 REC CONTROL

This setting is used to give access to the recording operations.

ADMIN: Only the administrator can control the recording operations. The user cannot control the recording operations.

USER: The user can also control the recording operations.

C-1 Turn ON the ADMIN and USER security locks and set passwords for the DVR

Refer to P67 for information on the control rights after setting the passwords.

- 1 Display the <SECURITY LOCK SET> screen as explained in "Displaying the general settings screen", and then turn the S-dial clockwise. (P62)
The first dash ("-") of the ADMIN setting starts blinking.

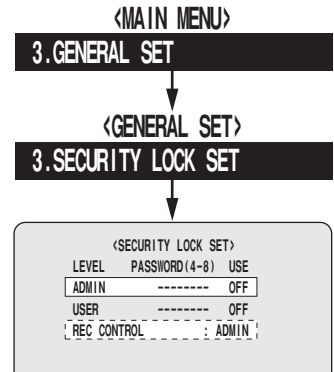
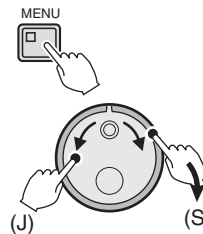

- 2 Set the ADMIN password (example: 12345AB).

- 1 Turn the J-dial, select "1", and then turn the S-dial clockwise.

Repeat the operation to enter the rest of the password.
The cursor moves to "OFF".

- 2 Turn the J-dial to select "ON", and then turn the S-dial twice clockwise.

The password entry area of the USER starts blinking.



- 3 Set the USER password (example: AB12345).

- 1 Turn the J-dial, select "A", and then turn the S-dial clockwise.

Repeat the operation to enter the rest of the password.
The cursor moves to "OFF".

- 2 Turn the J-dial to select "ON", and then turn the S-dial twice clockwise.

The "ADMIN" field of REC CONTROL starts blinking.



- 4 Turn the J-dial to select ADMIN or USER, and then turn the S-dial clockwise.

The cursor moves back to the ADMIN line.

- 5 Press the EXIT/OSD button.

General settings

C-2 Activating the security lock

When the administrator and user settings are complete, activate the security lock.

- 1 Press the **SHUTTLE HOLD** button for about 3 seconds while live video is on the screen.
The **LOCK** indicator on the front panel turns on and a buzzer sounds to indicate the activation of the security lock.

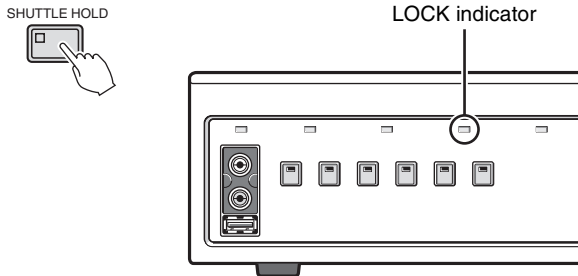

- 2 Press the **MENU** button to check that the security lock is activated.
The "**SECURITY LOCKED!**" screen appears for about 5 seconds, then the live video display returns.

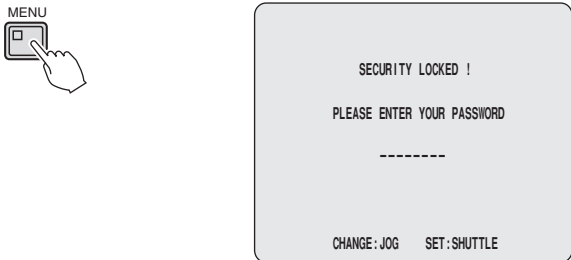

C-3 Cancelling the security lock

- 1 Press the **MENU** button.
The "**SECURITY LOCKED!**" screen appears for about 5 seconds.



- 2 Turn the **J-dial** and enter the password set for the **ADMIN** or the **USER** level, and then turn the **S-dial** clockwise.
 - **ADMIN: example 12345AB**
If the administrator password is entered, the **LOCK** indicator turns off, and the security lock will be cancelled.
The display returns to the normal live video screen.
 - **USER: example AB12345**
If the user password is entered, the **LOCK** indicator stays on, and the security lock will be cancelled only partially.

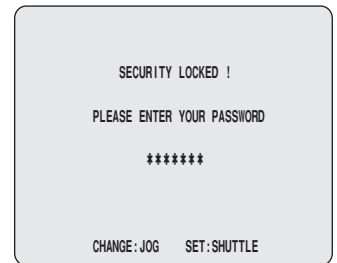
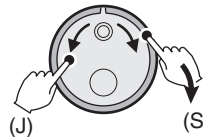

General settings

■ List of permitted operations after setting the passwords

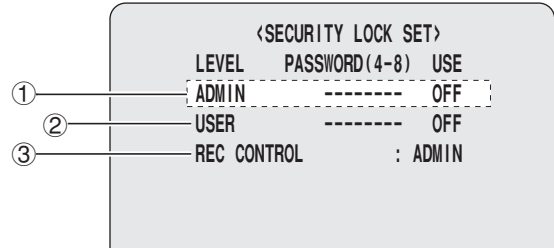

If both the ADMIN and USER are "ON":

- If the ADMIN password is entered, all operations will be permitted.
- If no password is entered, all operations will be denied.

Settings	① ADMIN	ON			
	② USER	ON			
	③ REC CONTROL	ADMIN	ADMIN	USER	USER
Password entered		ADMIN	ADMIN	USER	USER
		USER	USER	USER	USER
Operations	Surveillance Operation of the camera selection, [QUAD], [MULTI], [MON2], [EXIT/OSD] and [SEQUENCE] buttons	○	○	○	○
	Playback Operation of the [PLAY/STOP], [ZOOM], [SEARCH], [COPY], [STILL], [SHUTTLE HOLD] and [ALARM] buttons Jog-dial/Shuttle-dial operation	○	○	○	○
	Recording Operation of the [REC/STOP] and [TIMER] buttons	×	×	○	○
	Menu Operation of the [MENU] and [MENU RESET] buttons	×	×	×	×

If ADMIN is ON and USER is OFF:

- If the ADMIN password is entered, all operations will be permitted.
- USER password cannot be entered (since the setting is turned OFF)

Settings	① ADMIN	ON			
	② USER	OFF			
	③ REC CONTROL	ADMIN	ADMIN	USER	USER
Password entered		Not entered	Not entered	Not entered	Not entered
Operations	Surveillance Operation of the camera selection, [QUAD], [MULTI], [MON2], [EXIT/OSD] and [SEQUENCE] buttons	○	○	○	○
	Playback Operation of the [PLAY/STOP], [ZOOM], [SEARCH], [COPY], [STILL], [SHUTTLE HOLD] and [ALARM] buttons Jog-dial/Shuttle-dial operation	○	○	○	○
	Recording Operation of the [REC/STOP] and [TIMER] buttons	×	×	○	○
	Menu Operation of the [MENU] and [MENU RESET] buttons	×	×	×	×

General settings

D Hard disk settings menu description

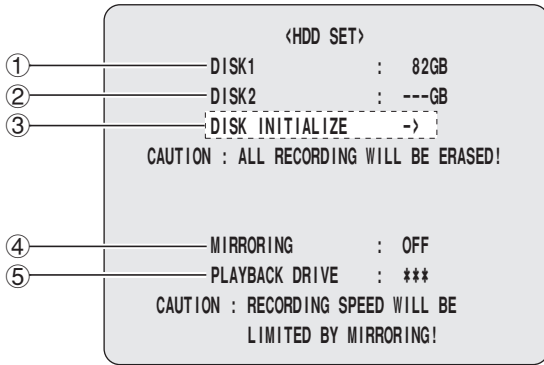

① DISK1

Displays the total capacity of the internal hard disk. If the hard disk is replaced, the capacity may change.

② DISK2

Displays the total capacity of the second hard disk, if it was installed in the DVR.

③ DISK INITIALIZE

This item is used to initialize the internal hard disk. All recordings are erased when the hard disk is initialized.

The initialization is performed on DISK1 and DISK2 simultaneously.

④ MIRRORING

If another hard disk is installed, and MIRRORING is turned "ON", then a PLAYBACK DRIVE can be selected, and the same video will be recorded on both hard disks. If a writing error occurs, one of DISK1 and DISK2 can be used to read the recordings.

- Note that if MIRRORING is turned "ON", the recording rate will be automatically limited (to half of the normal recording rate).
- If a playback problem occurs while MIRRORING is ON, change the hard disk used for playback by selecting DISK1 or DISK2 at the "PLAYBACK DRIVE" setting.

⑤ PLAYBACK DRIVE

Use this setting together with MIRRORING, to designate one of the two hard disks for video playback.

Selections: DISK1/DISK2

■ Hard disk expansion

Before installing another hard disk, consult with the store where you purchased your system.

We recommend using the expansion hard disk provided by SANYO. Operation is not guaranteed if a hard disk other than SANYO's recommended type is used for capacity expansion.

- The hard disks must be initialized, upon installing an expansion disk. The initialization is performed on the two hard disks simultaneously. Save your recordings on a CompactFlash card or other media before the initialization.

D-1 Hard disk initialization

1 Display the <HDD SET> screen using "Displaying the general settings screen". (P62)

The cursor moves to "DISK INITIALIZE".

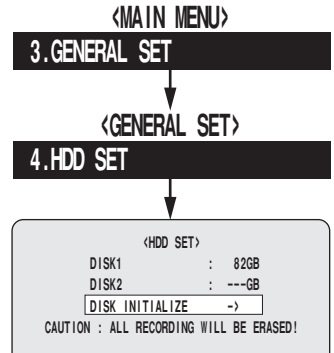
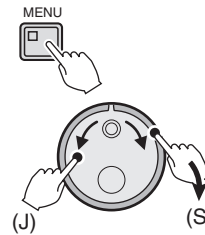

2 Turn the S-dial clockwise.

The <WARNING> screen is displayed, and "NO" is blinking.

3 Turn the J-dial, select "YES", and turn the S-dial clockwise.

The "HDD INITIALIZING !" message appears, and the initialization starts.

When the initialization is complete, the <HDD SET> screen returns.

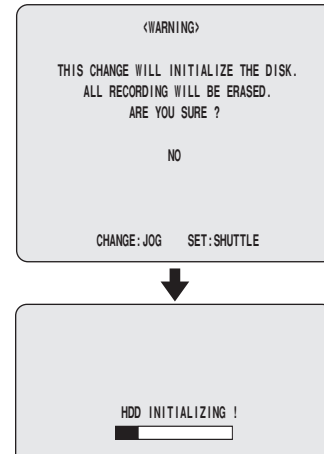

4 Press the EXIT/OSD button.



General settings

E Network settings

- 1** Connecting the DVR to the network
Refer to the Network connection terminals (LAN). (P11)
- 2** Display the <NETWORK SET> screen as explained in "Displaying the general settings screen", and then turn the S-dial clockwise. (P62)
The "OFF" field NETWORK CONTROL starts blinking.

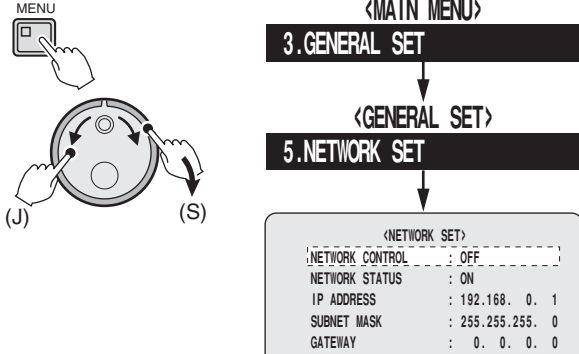

- 3** Turn the J-dial, select "ON(NETWORK)", and then turn the S-dial clockwise.
OFF: The DVR is not operated from the network.
ON (NETWORK): PC operations are given priority.
ON (DVR): DVR operations are given priority.
 The cursor moves to "NETWORK STATUS".

NETWORK CONTROL : ON(NETWORK)

- 4** Turn the S-dial clockwise. Turn the J-dial to select "ON" and then turn the S-dial clockwise.
The cursor moves to "IP ADDRESS".

NETWORK STATUS : ON

ON: Displays "NETWORK CONTROL" on the monitor screen.
OFF: Does not display the network status.

- 5** Repeat the operation to enter the rest of the setting items.
When connecting to the network, ask the network administrator for the IP ADDRESS, SUBNET MASK, GATEWAY and PORT settings.

- 6** Press the EXIT/OSD button.



E-1 Network password modification

There are three access levels (ID1, ID2, ID3) to connect to the network.

The default settings for the IDs are shown below:

NETWORK SET	
NETWORK CONTROL	: ON(NETWORK)
NETWORK STATUS	: ON
IP ADDRESS	: 192.168. 0. 1
SUBNET MASK	: 255.255.255. 0
GATEWAY	: 0. 0. 0. 0
PORT	: 00080
ID	PASSWORD (4-8)
ID1	: 1111----
ID2	: 2222----
ID3	: 3333----

- 1** Turn the J-dial, select "ID1", and then turn the S-dial clockwise.

The first password entry item "1" starts blinking.

ID1 : 1111----

• ID levels:

- ID1:** Live video surveillance can be conducted over the network.
- ID2:** Live video surveillance, recorded video playback and search can be conducted over the network.
- ID3:** The DVR and the main settings can all be controlled over the network.

- 2** Change the password.

Example: Set "ABC123" as the ID1 password.

- ①** Turn the J-dial, select "A", and then turn the S-dial clockwise.
The "1" at the second position starts blinking.
- ②** Turn the J-dial, select "B", and then turn the S-dial clockwise.
The "1" at the third position starts blinking.
- ③** Repeat the operation to enter the rest of the password.
Set the ID2, ID3 passwords as needed.

ID1 : ABC123--

- 3** Press the EXIT/OSD button.



General settings

F RS-485 settings

1 Connect the RS-485 terminal on the rear panel of the DVR with the system controller (Figure 1).

2 Display the <RS-485 SET> screen as explained in "Displaying the general settings screen", and then turn the S-dial clockwise. (P62)

The DATA SPEED "19200" indicator starts blinking.

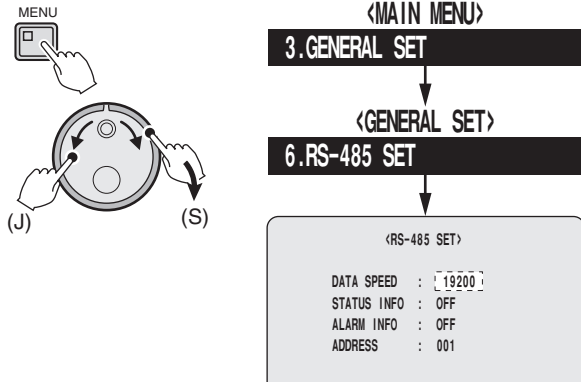

3 Turn the J-dial to select the desired DATA SPEED (example: 9600), and then turn the S-dial twice clockwise.

Selections: 2400/4800/9600/19200

The "OFF" indicator of STATUS INFO starts blinking.

STATUS INFO : OFF

4 Repeat the procedure for selecting the desired settings for each item.

• **STATUS INFO**

OFF: The status information will not be sent.

ON: The status information will be sent.

• **ALARM INFO**

OFF: The alarm information will not be sent.

ON: The alarm information will be sent.

• **ADDRESS**

The address should be between 000~127.

Refer to the system controller's instruction manual for more information about the control method.

5 Press the EXIT/OSD button.



Figure 1 (Do not use telephone wires.)

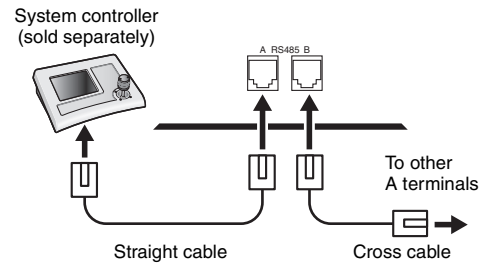

The DVR supports straight and cross-type cables.

• **Straight type:**

A straight cable connects connector "A" to "A", and "B" to "B" of the RS-485 connectors.

• **Cross type:**

A cross cable connects connector "A" with "B", and "B" with "A" on the RS-485 connectors.

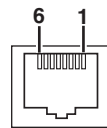

Pin number	Connector A	Connector B
1	Not used	Not used
2	Not used	Not used
3	A	B
4	B	A
5	Not used	Not used
6	Not used	Not used

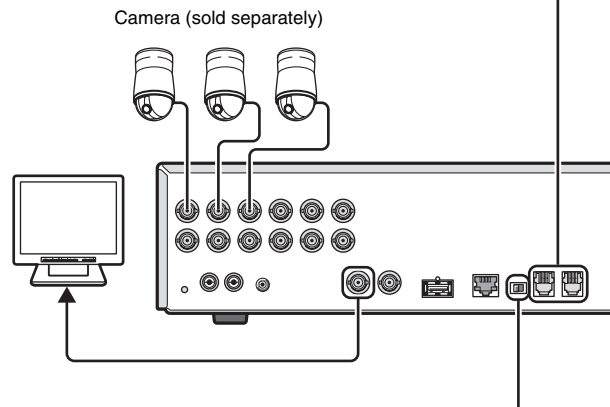

Terminator switch settings

If multiple devices are connected, terminator settings are necessary at both ends. If the terminator settings are not correct, correct data will not be sent to the devices.

- Set the terminator switch on both ends (first device and last device) to "ON", and set it to "OFF" on all other devices.

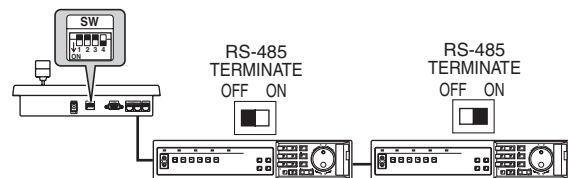

Screen settings

Menu configuration

■ Displaying the screen settings

- 1** Press the MENU button and use the J-dial to select "4. SCREEN SET", and then turn the S-dial clockwise.

The <SCREEN SET> screen appears.

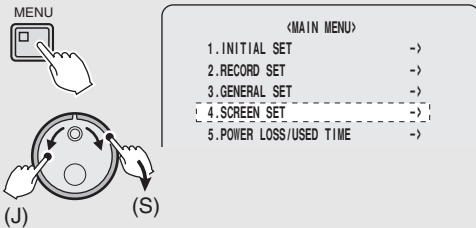

- 2** Turn the J-dial, select the desired submenu, and turn the S-dial clockwise.

The selected screen (A~D) is displayed. Refer to the appropriate pages for the settings.

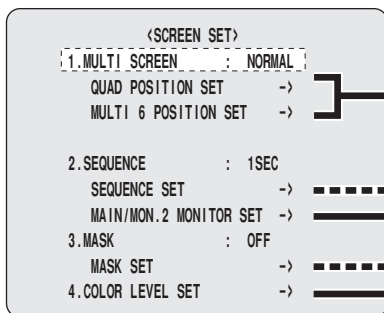
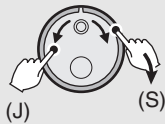

A Changing the multi-screen position (P72)

Screen-position modification for live video and playback.

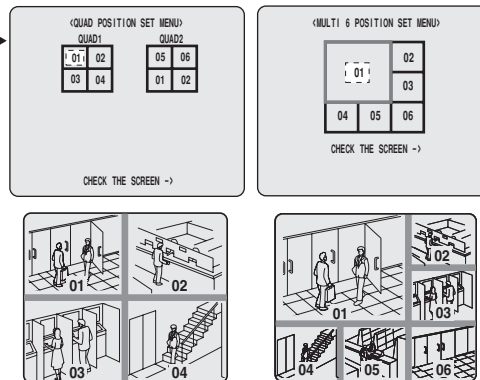

B Switching screen at time intervals (P73)

- This setting is used to scroll all live videos based on preset time intervals.

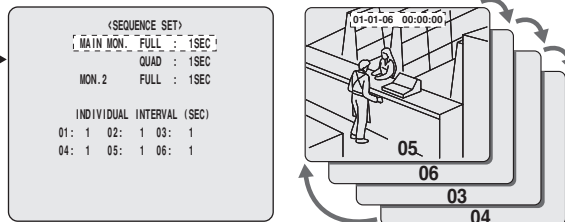

- This setting specifies the monitor to use for live video display during the time set in the time period settings (TIME PERIOD A/B).

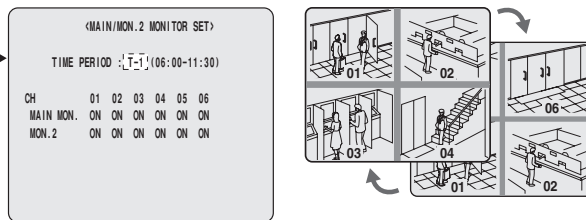

C Masking specific camera images (P75)

This setting specifies when to use a gray pattern to mask certain camera video on the screen.

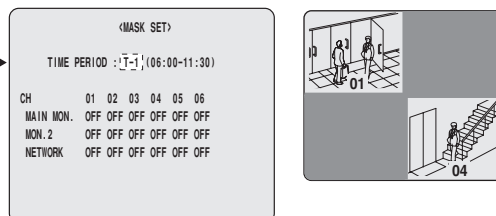

D Adjusting color tones of the live video (P76)

This setting is used to adjust the color tone of the video on the monitor.



Screen settings

A Changing the multi-screen position

- 1 Display the <SCREEN SET> screen as explained in "Displaying the screen settings", and then turn the S-dial clockwise. (P71)

The "NORMAL" field of 1. MULTI SCREEN starts blinking.

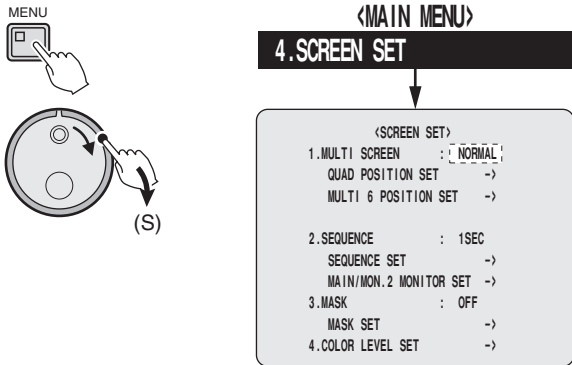

- 2 Turn the J-dial, select "CHANGE", and then turn the S-dial clockwise.

Selections:

NORMAL: No specified display positions for multi-screen display

CHANGE: Specified positions for multi-screen (quad/6) display

The cursor moves to "QUAD POSITION SET".

Turn the J-dial and select the quad or multi-6 screen as shown below, for changing the display positions.

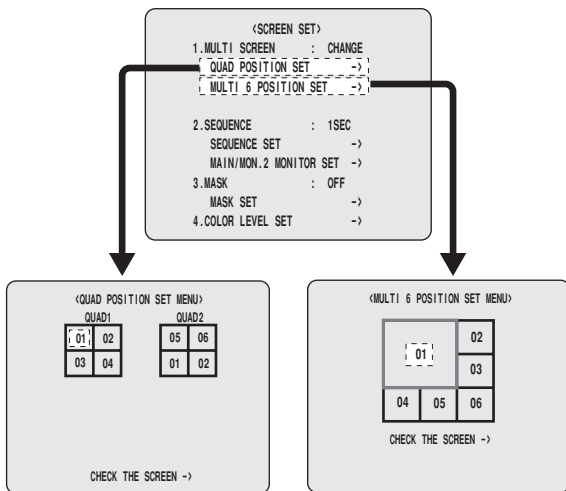

- 3 Example: Switching from the camera 1 image to the camera 5 image

- 1 Turn the J-dial, select "QUAD POSITION SET", and then turn the S-dial clockwise. The <QUAD POSITION SET MENU> screen appears.
- 2 Turn the J-dial, select "01" to "QUAD1", and then turn the S-dial clockwise. The "01" indicator starts blinking.
- 3 Turn the J-dial, select "05", and turn the S-dial clockwise.

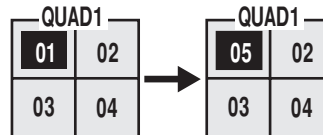

- 4 Turn the J-dial, select "CHECK THE SCREEN", and then turn the S-dial clockwise. The <CHECK DISPLAY POSITION> screen with live video appears. Check if camera 1 was replaced by camera 5. Press the QUAD button to check the screen of "QUAD2" and beyond.

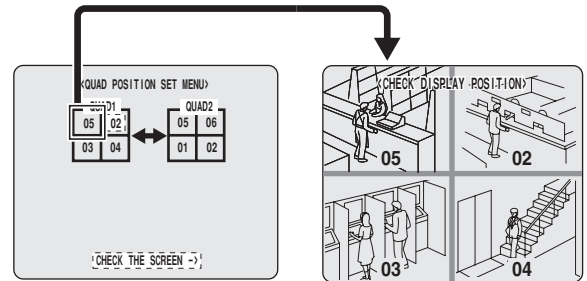

- 5 Turn the S-dial counterclockwise. The <QUAD POSITION SET MENU> screen returns.

- 4 Press the EXIT/OSD button.

Press the "QUAD" or the "MULTI" buttons on the normal live display to see the order of the display changed.



Screen settings

B Automatic scrolling of live video of the main monitor and the monitor 2 at identical intervals (example: 5 seconds)

1 Display the <SCREEN SET> screen as explained in "Displaying the screen settings" (P71).

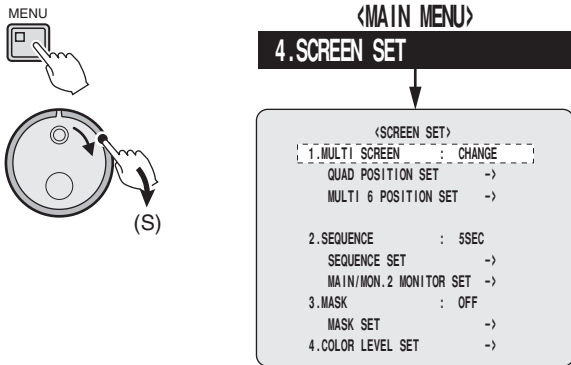

2 Turn the J-dial to select "2. SEQUENCE", and then turn the S-dial clockwise.

Selections: 1/2/ ... 29/30SEC/INDIV.

The "1SEC" indicator starts blinking.

After specifying the number of seconds, the cursor will not move to the "SEQUENCE SET" position. This way the automatic sequence will be set to the same interval.

2. SEQUENCE : 1SEC

3 Turn the J-dial to select the 2. SEQUENCE (example: 5 seconds), and then turn the S-dial clockwise.

2. SEQUENCE : 5SEC

4 Press the EXIT/OSD button.



5 Press the SEQUENCE button.



B-1 Automatic scrolling of live video of the main monitor and the monitor 2 at individual intervals

1 Display the <SCREEN SET> screen as explained in "Displaying the screen settings" (P71).

2 Turn the J-dial to select "2. SEQUENCE", and then turn the S-dial clockwise.

Selections: 1/2/ ... 29/30SEC/INDIV.

The "1SEC" indicator starts blinking.

2. SEQUENCE : 1SEC

3 Turn the J-dial to select "INDIV.", and then turn the S-dial twice clockwise.

The <SEQUENCE SET> screen appears.



4 Turn the S-dial clockwise.

The "1SEC" of MAIN MON. FULL starts blinking.

5 Setting the interval time between the MAIN MON. and the MON2.

1 Turn the J-dial to select "5SEC" for "MAIN MON. FULL", and then turn the S-dial twice clockwise.

Selections: 1/2/ ... 29/30SEC/INDIV.

2 Turn the J-dial to select "10SEC" for "MAIN MON. QUAD", and then turn the S-dial twice clockwise.

Selections: 1/2/ ... 29/30SEC

3 Turn the J-dial to select "15SEC" for "MON.2 FULL", and then turn the S-dial clockwise.

Selections: 1/2/ ... 29/30SEC/INDIV.

MAIN MON. FULL : 5SEC
QUAD : 10SEC
MON. 2 FULL : 15SEC

6 Press the EXIT/OSD button.



7 Press the SEQUENCE button.

The monitor video will be switched the following way:

- Main monitor full-screen video every 5 seconds
- Main monitor quad-screen video every 10 seconds
- Monitor 2 full-screen video every 15 seconds



Screen settings

B-2

Automatic sequence of live video of the main monitor (full-screen) at individual intervals, and of the monitor 2 at identical intervals (example: 3 seconds)

- 1** Display the <SCREEN SET> screen as explained in "Displaying the screen settings" (P71).
- 2** Turn the J-dial, select "2. SEQUENCE", and then turn the S-dial clockwise.
- 3** Turn the J-dial to select "INDIV.", and then turn the S-dial twice clockwise.
- 4** Turn the S-dial clockwise.
- 5** Turn the J-dial, select "INDIV." for the MAIN MON. FULL, and then turn the S-dial clockwise.
MAIN MON. QUAD cannot be set to "INDIV."
- 6** Turn the J-dial to select "MON.2 FULL", and then turn the S-dial clockwise.
The "1SEC" (example) indicator starts blinking.
- 7** Turn the J-dial to select "3SEC", and then turn the S-dial twice clockwise.
1 SEC of channel 1 (01) under "INDIVIDUAL INTERVAL (SEC)" starts blinking.
- 8** Turn the J-dial to set the interval for channel 1 (01) of the main monitor (example: 5), and then turn the S-dial clockwise.
Repeat the procedure for setting the interval for the other channels.

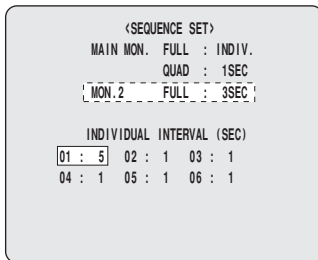

- 9** Press the EXIT/OSD button.



- 10** Press the SEQUENCE button.

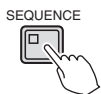

B-3

Turning off display of specified cameras during timer-controlled periods

- 1** Set TIME PERIOD A and TIME PERIOD B using <TIME PERIOD SET> (P37).
Select "TIME PERIOD A" or "TIME PERIOD B" for "SEQUENCE" under "SELECT TIME PERIOD".
The example uses "TIME PERIOD A".

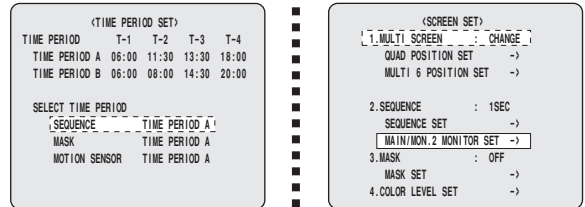

- 2** Turn the J-dial on the <SEQUENCE SET> screen to select "MAIN/MON.2 MONITOR SET", and then turn the S-dial twice clockwise.
The <MAIN/MON.2 MONITOR SET> screen appears, and "T-1" at TIME PERIOD starts blinking.

TIME PERIOD : T-1 (06:00-11:30)

- 3** Turn the J-dial to select the desired TIME PERIOD (example: T-2), and then turn the S-dial twice clockwise.
The "ON" indicator at CH 01 on the MAIN MON. line starts blinking.

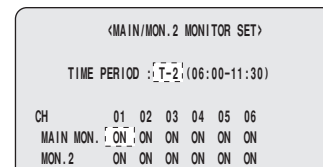

- 4** Turn the J-dial, select "OFF", and turn the S-dial. Repeat the procedure to turn "OFF" the display of all desired cameras.

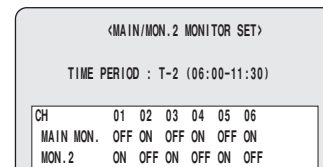

- 5** Press the EXIT/OSD button.



- 6** Press the SEQUENCE button.



Screen settings

C Masking specific camera images

1 Set TIME PERIOD A and TIME PERIOD B using <TIME PERIOD SET> (P37).

Select "TIME PERIOD A" or "TIME PERIOD B" for "MASK" under "SELECT TIME PERIOD".

The example uses "TIME PERIOD A".

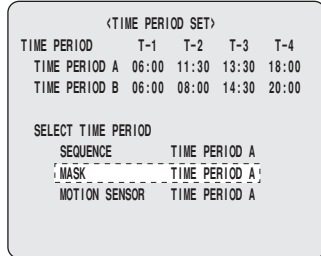

2 Display the <SCREEN SET> screen as explained in "Displaying the screen settings" (P71).

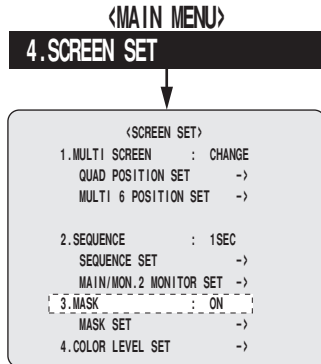
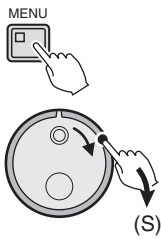

3 Turn the J-dial, select "3. MASK", and then turn the S-dial clockwise.

The "OFF" starts blinking.

4 Turn the J-dial, select "ON", and turn the S-dial clockwise.

The cursor moves to "MASK SET".



5 Turn the S-dial clockwise.

The <MASK SET> screen appears and the cursor moves to "T-1".

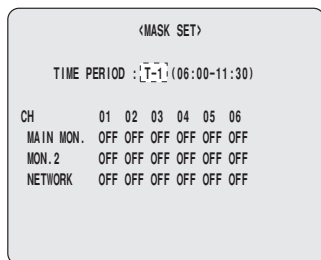

6 Turn the S-dial, and use the J-dial to select the desired TIME PERIOD (example: T-2), and then turn the S-dial clockwise.

The cursor moves to "01" (CH) of the MAIN MON. line.

7 Turn the J-dial to select the camera number (example: 03) of the MAIN MON., and then turn the S-dial clockwise.

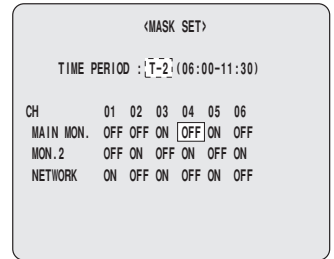

8 Turn the J-dial, select "ON", and turn the S-dial clockwise.

Repeat the procedure to turn the masking "ON" for all desired cameras on MON.2 and on NETWORK.

9 Press the EXIT/OSD button.



Screen settings

D Adjusting color tones of the live video

- 1 Display the <SCREEN SET> screen as explained in "Displaying the screen settings" (P71).

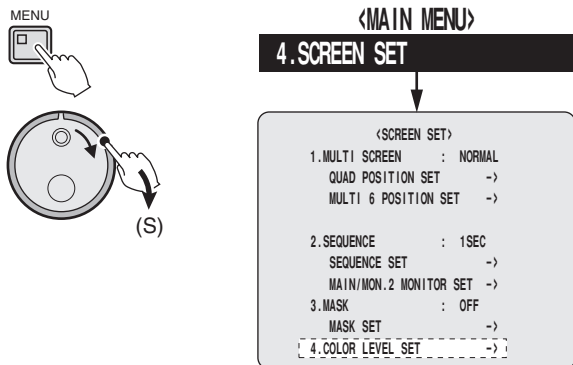

- 2 Turn the J-dial, select "4. COLOR LEVEL SET", and then turn the S-dial clockwise.

The <COLOR LEVEL SET> screen of CH01 appears, and the cursor moves to "COLOR LEVEL".

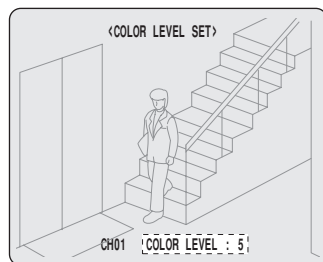

- 3 Press the camera selection button (example: 4) of the channel where you want to adjust the color level, and then turn the S-dial clockwise.

The channel switches to "CH04", and the "5" field at COLOR LEVEL starts blinking.

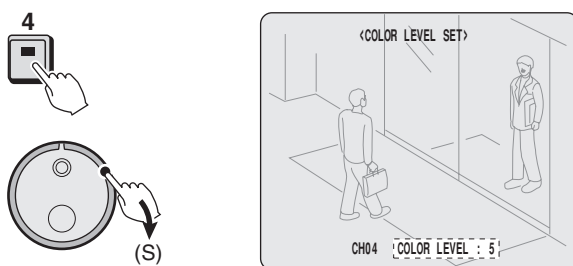

- 4 Turn the J-dial, select the desired COLOR LEVEL, and then turn the S-dial clockwise.

Selections: 1/2.../8/9/10 (darker)

The color tone of the camera video changes.

- 5 Press the EXIT/OSD button.



Power loss information/Used time

A Power loss/Used time menu description

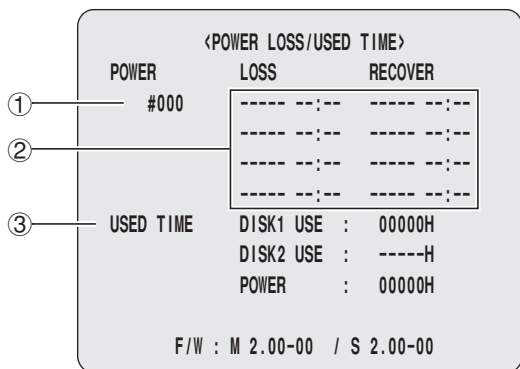

① Power loss

Displays the number of power outages.

The maximum display of the power outage counter is 999. A count over 999 cannot be displayed.

② LOSS and RECOVER

Displays information about the most recent power loss events (loss date and time, recovery date and time), in reverse chronological order, up to four events. Information about earlier events is not available.

③ USED TIME

• DISK1 USE

Displays the total running time of hard disk 1.

• DISK2 USE

Displays the total running time of hard disk 2. If there is no second hard disk installed, "----" is displayed.

• POWER

Displays the total power-on time of the DVR.

A-1 Viewing the information

Use this procedure to view the power loss dates and times, hard disk running times, and the power-on time of the DVR.

- 1 Press the MENU button, turn the J-dial, select "5. POWER LOSS/USED TIME", and then turn the S-dial clockwise.

The <POWER LOSS/USED TIME> screen appears.

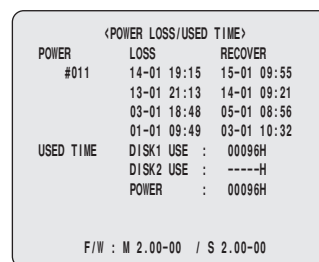
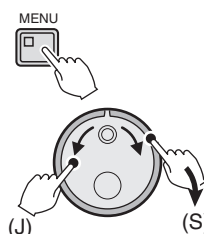

- 2 Press the EXIT/OSD button to exit.



Initialization log

A Initialization log menu description

①	②	③
DATE	TIME	AREA
----	--:--	----- (-----)
----	--:--	----- (-----)
----	--:--	----- (-----)
----	--:--	----- (-----)
----	--:--	----- (-----)
----	--:--	----- (-----)
----	--:--	----- (-----)
----	--:--	----- (-----)

① DATE/TIME

Displays the date and time of the initialization.
 Displays the eight most recent items in the initialization log. Information about earlier initializations is not available.

② AREA

Displays the hard disk recording area that was initialized.

Display:

ALL AREAS, NORMAL REC, ARCHIVE, ALARM REC

③ Operations

Displays whether the area was INITIALIZED or subject to AREA RESET.

Recording area modifications are displayed as "INITIALIZED".

A-1 Viewing the log

Use this procedure to view the hard disk initialization and area reset log. The log displays the eight most recently performed operations.

- 1 Press the MENU button, turn the J-dial, select "6.INITIALIZATION LOG", and then turn the S-dial clockwise.

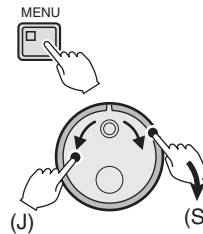

The <INITIALIZATION LOG> screen appears.

<MAIN MENU>	
1. INITIAL SET	->
2. RECORD SET	->
3. GENERAL SET	->
4. SCREEN SET	->
5. POWER LOSS/USED TIME	->
6. INITIALIZATION LOG	->
7. COPY MENU SETTINGS	->

MOVE: JOG SELECT: SHUTTLE



<INITIALIZATION LOG>		
DATE	TIME	AREA
26-10	18:25	ALL AREAS (INITIALIZED)
26-10	23:18	ALL AREAS (INITIALIZED)
26-10	23:18	ARCHIVE (AREA RESET)
26-10	23:18	ALARM REC (AREA RESET)
26-10	23:18	NORMAL REC (AREA RESET)
26-10	23:16	ALL AREAS (INITIALIZED)
26-10	23:15	ALL AREAS (INITIALIZED)
----	--:--	----- (-----)

- 2 Press the EXIT/OSD button to exit.



Menu copy

A Menu copy screen description

Save the set menu on the CompactFlash (CF) card and load the same menu onto a different DVR of the same model. It is possible to control several units using the same menu.

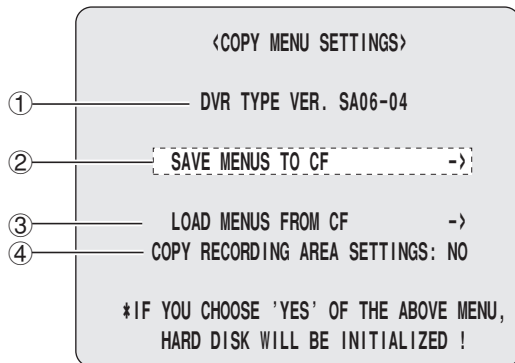

- ① DVR version number
- ② Select when saving the settings of the DVR to a CF card.
- ③ Select when loading the settings of another DVR of the same model from a CF card.
- ④ Selecting the area distribution of the recording area
Select the below item before performing "LOAD MENUS FROM CF" in ③.

Selections:

NO: Load the menu content from the CF card without altering the area distribution of the hard disk recording area (normal, alarm, archive).

YES: Alter the area distribution of the hard disk recording area (normal, alarm, archive) and load the menu content from the CF card.

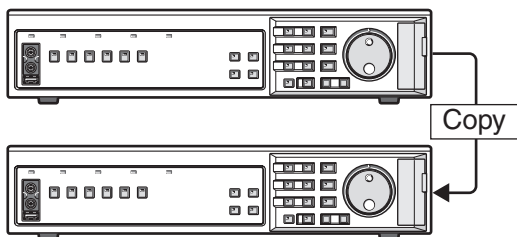

A-1 Save the menu content in the CF card.

- 1 Insert the CF card into the CF card slot

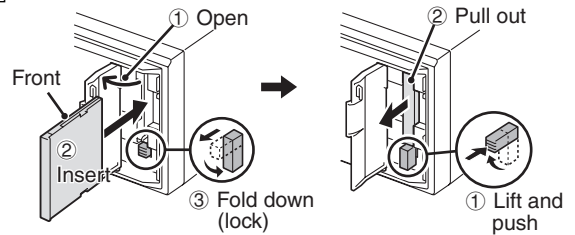

- 2 Press the MENU button and turn the J-dial to select "7. COPY MENU SETTINGS", and then turn the S-dial clockwise.

The <COPY MENU SETTINGS> screen is displayed.

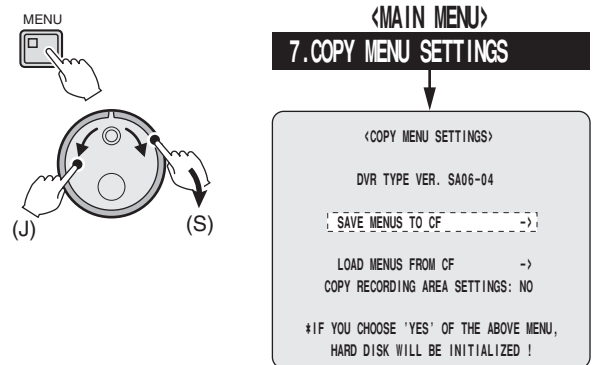

- 3 Turn the S-dial clockwise, select "YES" by turning the J-dial, and then turn the S-dial clockwise.

Save the menu on the CF card.

"SAVING FINISHED!!" is displayed when saving is finished.

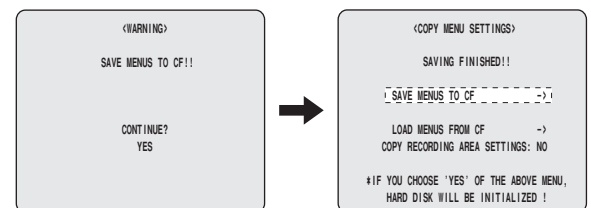

Menu copy

A-2 Load menu content saved to the CF card onto other DVRs of the same model.

- 1 Press the MENU button in order to display the <COPY MENU SETTINGS> screen and load the menu content onto other DVRs of the same model.

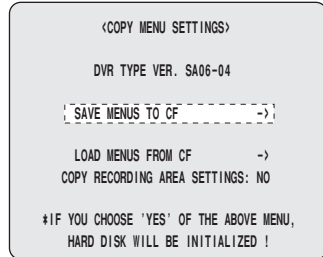

- 2 Turn the J-dial to move the COPY RECORDING AREA SETTINGS.



- 3 Turn the S-dial clockwise. Select NO or YES using the J-dial.

- 4 Turn the S-dial clockwise. The cursor moves to "SAVE MENUS TO CF".



- 5 Turn the J-dial to move the cursor to "LOAD MENUS FROM CF" and then the S-dial clockwise.



A) When "NO" is selected for COPY RECORDING AREA SETTINGS.

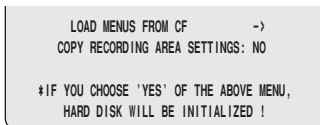

The <WARNING> screen will be displayed with a blinking "NO". Turn the J-dial and select "YES" and then turn the S-dial clockwise.

Load from the CF card without altering the area distribution in the recording area.

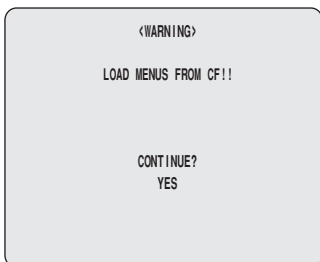

B) When "YES" is selected for COPY RECORDING AREA SETTINGS (Initialized).

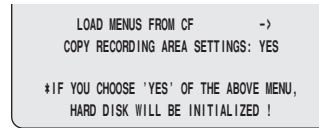

The <WARNING> screen will be displayed with a blinking "NO". Turn the J-dial and select "YES" and then turn the S-dial clockwise.

Change the area distribution in the recording area and load from the CF card.



- 6 The monitor screen will display "SYSTEM INITIALIZING" and live videos will be shown, once loading is complete.

Interface (RS-485) specifications

■ Data format

Mode	Asynchronous
Character length	8 bits
Data transmission speed	2400, 4800, 9600, 19200bps
Parity check	None
Stop bit	1 bit

■ Communication protocol

It is recommended that the exclusive controller is used for operation as a protocol unique to our company (SANYO protocol) is used for this DVR. Consult the service center regarding the exclusive controller.

■ Protocol command table

The commands available through this DVR are as outlined in the table below.

Lower level \ Upper level	0	1	2	3	4	5	6	7
0				0			TIMER ON/OFF	
1				1				
2				2				
3				3		SHIFT←	SHIFT→	
4				4		SHIFT↑	SHIFT↓	MENU
5				5			SET+ /RP UP	
6				6			SET- /RP DOWN	
7				7				
8				8				
9				9			SECURITY LOCK ON	
A	ACK			PLAY	REV PLAY/ SEARCH (DVR)			
B	NAK							
C							GROUP SET	
D							GROUP CHECK	
E							GROUP CLEAR	
F				STOP	STILL			

Lower level \ Upper level	8	9	A	B	C	D	E	F
0		FULL 1					CLOCK ADJUST	
1		FULL 2					MENU RESET	
2	MULTI (MPX)	FULL 3						
3	QUAD (MPX)	FULL 4						
4	PLUS1 (MPX)	FULL 5						
5	ZOOM (MPX/DVR)	FULL 6						
6								
7	SEQUENCE (MPX)							
8	MONITOR2 (MPX)							
9							CLOCK DOWNLOAD	
A	ALARM RESET				REC			REC/DUB REQUEST
B			FF/ALARM F					
C			REW/ALARM R					
D	COPY							RS-485 SEND START
E	EXIT/OSD							RS-485 RCV CMF.
F				STATUS LOG1	REC STOP			

Specifications

Signal method	PAL signal standard
Compression method	Video: M-JPEG, Audio: WAVE
Number of pixels	720 x 288
Recording type	Field record
Recording quality	5 stage [BASIC/NORMAL/ENHANCED/FINE/SUPER FINE]
Recording rate	27 levels (50 to 0.033FPS)
Recording area	Normal recording area/alarm recording area/archive area
Zoom	2x digital zoom is possible using the ZOOM button
Search mode	Date and time search, alarm search, alarm thumbnail search, archive area search, motion detection search
Date/time display	Day, month, year, hour, minute, second
Date/time display position	Can be moved to upper and lower (2) positions (Display can be switched on/off)
Camera title display	10 characters max (alphabetical, numeric, symbols) can be inputted to each channel (display can be switched on/off)
Memory backup	Approximately 30 days (after power is supplied for more than 48 hours)
Video input	1.0 V (p-p) 75 Ω BNC x6
Video output	Through output BNC of each video input x6
Main monitor output	1.0 V (p-p) 75 Ω BNC x1
Monitor 2 output	1.0 V (p-p) 75 Ω BNC x1
Audio input	-8 dBs 27 kΩ unbalanced RCA x1
Audio output	-8 dBs 600 kΩ unbalanced RCA x1
Microphone input	-60 dBs 10 kΩ unbalanced 3.5 mm Monaural mini jack x1
Front AV output	Video output
	Audio output

Please note that specifications and unit exterior design are subject to change without notification.

Character table for Camera title

A	B	C	D	E	F	G	H	I	J	K	L	M	N	O	P	Q	R	S	T	U
V	W	X	Y	Z	0	1	2	3	4	5	6	7	8	9	-	:	.	/	*	

Dimensions (unit: mm)

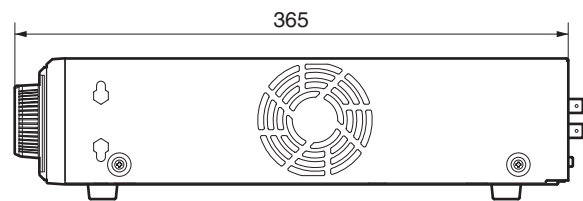
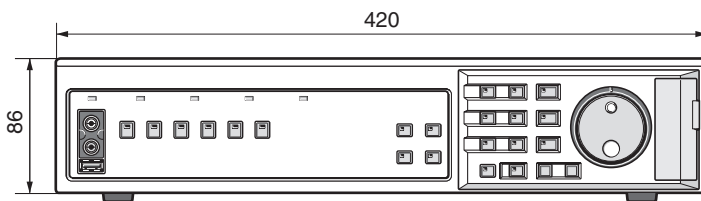

Options

HDD: 80GB/160GB/300GB/500GB

CD-R/RW: Expanded disc unit

CompactFlash slot	CompactFlash Type 2 (front panel) x1
Terminal	
LAN	10BASE-T/100BASE-TX, RJ-45 x1, compatible protocol: UDP, TCP/IP, HTTP server
RS-485	RJ-11 x2 (with termination switch)
USB (1.1 A terminal)	Front 1/Rear 1
Alarm input	Zero voltage make connection (pulse width 100m/second and over) x6
Sensor alarm output	Open collector/1kΩ, Low level active (max. 25 mA) x6
Remote control input	2 wire voltage control method x2
Clock adjustment input	Zero voltage contact (pulse width 100m/second and over) x1
Clock adjustment output	Open collector/1kΩ, Low level active
Alarm total output	Open collector/Low level active (max. 500 mA) x1
Alarm reset input	Zero voltage contact (pulse width 100m/second and over) x1
Abnormality warning output	Normal DC 5V, Low level active x1
Normal recording area remaining warning output	Normal DC 5V, Low level active x1
Alarm recording area remaining warning output	Normal DC 5V, Low level active x1
Series recording connecting input	Normal DC 5V, Low level active x1
Series recording connecting output	Open collector/1kΩ, Low level active x1
External timer input	Zero voltage contact (pulse width 100m/second and over) x1
Non rec output	Normal DC 5V, Low level active x1
Power supply voltage	AC 120 – 240 V, 50/60 Hz
Current consumption	800 mA
Allowable operation temperature	5 to 40°C
Allowable operation humidity	10 to 80 %
Dimensions	420 (W) x 86 (H) x 365 (D) mm
Weight	Approx. 6 kg

List of recording rate and recording times

The recording time on this DVR are adjusted automatically when the recording rate and the recording quality have been altered. The list below displays the recording rate and quality when recording images within the hard disk normal recording area of this DVR.

- The set times for the normal recording area and/or the alarm recording area will be the product of the recording time shown below by the percentage figure of the normal recording area capacity (set in the recording area settings) or the alarm recording area capacity.
- The recording time may vary according to the image quality being recorded.

■ When recording using an 160GB hard disk (when 99% of the area is utilized)

Recording rate (fields/second)	Recording time				
	BASIC 15kB	NORMAL 22kB	ENHANCED 30kB	FINE 42kB	SUPER FINE 50kB
50	48 (H)	34 (H)	25 (H)	18 (H)	15 (H)
25	96	68	51	37	31
16.67	144	102	76	55	47
12.5	192	136	102	74	62
8.333	288	204	153	111	94
6.25	384	272	204	148	125
5	481	340	255	185	157
4.167	577	408	306	223	188
3.571	673	477	357	260	220
3.125	769	545	408	297	251
2.778	866	613	460	334	283
2.5	962	681	511	371	314
2.273	1058	749	562	408	346
1.923	1251	886	664	483	408
1.667	1443	1022	766	557	471
1.471	1635	1158	869	632	534
1.316	1828	1295	971	706	597
1.190	2020	1431	1073	780	660
1.087	2213	1567	1175	855	723
1	2405	1704	1278	929	786
0.5	4811	3408	2556	1859	1573
0.333	7217	5112	3834	2788	2359
0.25	9623	6816	5112	3718	3146
0.2	12028	8520	6390	4647	3932
0.1	24057	17041	12780	9295	7865
0.05	48115	34082	25561	18590	15730
0.033	72173	51123	38342	27885	23595

■ When recording using an 300GB hard disk (when 99% of the area is utilized)

Recording rate (fields/second)	Recording time				
	BASIC 15kB	NORMAL 22kB	ENHANCED 30kB	FINE 42kB	SUPER FINE 50kB
50	90 (H)	64 (H)	48 (H)	34 (H)	29 (H)
25	181	128	96	69	59
16.67	271	192	144	104	88
12.5	362	256	192	139	118
8.333	543	384	288	209	177
6.25	724	513	384	279	236
5	905	641	481	349	296
4.167	1086	769	577	419	355
3.571	1268	898	673	489	414
3.125	1449	1026	769	559	473
2.778	1630	1154	866	629	533
2.5	1811	1283	962	699	592
2.273	1992	1411	1058	769	651
1.923	2355	1668	1251	909	769
1.667	2717	1924	1443	1049	888
1.471	3079	2181	1636	1189	1006
1.316	3442	2438	1828	1329	1125
1.190	3804	2694	2021	1469	1243
1.087	4166	2951	2213	1609	1362
1	4528	3208	2406	1749	1480
0.5	9057	6416	4812	3499	2961
0.333	13586	9624	7218	5249	4441
0.25	18115	12832	9624	6999	5922
0.2	22644	16040	12030	8749	7403
0.1	45289	32080	24060	17498	14806
0.05	90579	64160	48120	34996	29612
0.033	135868	96240	72180	52494	44418

Audio signal recordable area (the recording time will be shorter than the figures given below in case audio is recorded)

List of recording rate and recording times

■ When recording using an 500GB hard disk (when 99% of the area is utilized)

Recording rate (fields/second)	Recording time				
	BASIC	NORMAL	ENHANCED	FINE	SUPER FINE
	15kB	22kB	30kB	42kB	50kB
50	151 (H)	107 (H)	80 (H)	58 (H)	49 (H)
25	302	214	160	116	98
16.67	453	321	241	175	148
12.5	604	428	321	233	197
8.333	907	642	482	350	296
6.25	1209	857	642	467	395
5	1512	1071	803	584	494
4.167	1814	1285	964	701	593
3.571	2117	1499	1124	818	692
3.125	2419	1714	1285	934	791
2.778	2722	1928	1446	1051	889
2.5	3024	2142	1606	1168	988
2.273	3327	2356	1767	1285	1087
1.923	3932	2785	2089	1519	1285
1.667	4537	3213	2410	1753	1483
1.471	5142	3642	2731	1986	1681
1.316	5747	4070	3053	2220	1878
1.190	6352	4499	3374	2454	2076
1.087	6957	4927	3695	2687	2274
1	7562	5356	4017	2921	2472
0.5	15124	10712	8034	5843	4944
0.333	22686	16069	12052	8765	7416
0.25	30248	21425	16069	11686	9888
0.2	37810	26782	20086	14608	12361
0.1	75620	53564	40173	29217	24722
0.05	151240	107129	80346	58434	49444
0.033	226861	160693	120520	87651	74166

Audio signal recordable area (the recording time will be shorter than the figures given below in case audio is recorded)

List of record rate setting/pre-alarm recording times

Recording rate setting

Recording rate (FPS)	Normal recording (Note 1)	Alarm recording	Pre-alarm recording (Note 2)	Program recording (Note 1)
50	○ (Note 3)	×	×	×
25	○	○	○	○
16.67	○	○	○	×
12.5	○	○	○	○
8.333	○	○	○	×
6.25	○	○	○	○
5	○	○	○	×
4.167	○	○	○	×
3.571	○	○	○	×
3.125	○	○	○	○
2.778	○	○	○	×
2.5	○	○	○	×
2.273	○	○	○	×
1.923	○	○	○	×
1.667	○	○	○	×
1.563	×	×	×	○
1.471	○	○	○	×
1.316	○	○	○	×
1.190	○	○	○	×
1.087	○	○	○	×
1	○	○	○	○
0.5	○	○	×	○
0.333	○	○	×	○
0.25	○	○	×	○
0.2	○	○	×	○
0.1	○	○	×	○
0.05	○	○	×	○
0.033	○	○	×	○
Off	×	×	×	○

(Note 1) Rate setting will be limited when the mirroring function is turned "ON" or when the pre-alarm recording is turned "ON".

(Note 2) Rate setting will be limited when the mirroring function is turned "ON".

(Note 3) It is not possible to choose this setting when only one camera is connected.

(Note) The recording rate for each channel is set in program recording. The rates that allow setting in each channel are calculated automatically.

Pre-alarm recording time

This is a list of the recording time for pre-alarm recording. Use this list when carrying out pre-alarm recording.

Recording rate (fields/second)	Recording time (Menu time information displayed on screen: s: seconds m: minutes)											
	3s (3s)	5s (5s)	10s (10s)	20s (20s)	40s (40s)	60s (1m)	120s (2m)	180s (3m)	240s (4m)	300s (5m)	600s (10m)	900s (15m)
25	○	○	○	○	○	○	○	○	○	○	○	○
16.67		○	○	○	○	○	○	○	○	○	○	○
12.5		○	○	○	○	○	○	○	○	○	○	○
8.333			○	○	○	○	○	○	○	○	○	○
6.25			○	○	○	○	○	○	○	○	○	○
5				○	○	○	○	○	○	○	○	○
4.167				○	○	○	○	○	○	○	○	○
3.571				○	○	○	○	○	○	○	○	○
3.125				○	○	○	○	○	○	○	○	○
2.778				○	○	○	○	○	○	○	○	○
2.5					○	○	○	○	○	○	○	○
2.273					○	○	○	○	○	○	○	○
1.923					○	○	○	○	○	○	○	○
1.667						○	○	○	○	○	○	○
1.471						○	○	○	○	○	○	○
1.316						○	○	○	○	○	○	○
1.190						○	○	○	○	○	○	○
1.087						○	○	○	○	○	○	○
1						○	○	○	○	○	○	○

Default setting, recording rate: 12.5FPS, recording time: to be set at 1 minute.

Alarm duration can only be set according to the set recording rate in the alarm duration settings under the menu function.

Also, when setting the recording rate, the setting range is limited depending on the set duration. For example, the recording rate will be limited to 25FPS when the alarm duration is set to 3 seconds.

Alter the settings of the alarm duration before setting a fast recording rate.

Push-lock terminal specifications

Input/output terminals	Signal level	Input/output circuit
<ALARM IN> [0 voltage contact]		
<SENSOR ALARM OUT> [Open collector/1kΩ, Low Level active (max. 25 mA)]		
<Control terminals>	(Refer to P12)	
Remote input [2 wire voltage control type] (REMOTE R1, R2)		
Date adjustment input [Zero voltage contact] (CLOCK IN)		
Clock adjustment output [Open collector/1kΩ, Low Level active (max. 25 mA)] (CLOCK OUT)		
Alarm total output [Open collector/Low Level active (max. 500 mA)] (ALARM OUT)		
Alarm reset input [Zero voltage contact] (ALARM RESET)		
Abnormal warning output [DC5V/5.7kΩ, Active Low] (WARNING OUT)		
Normal recording area remaining level warning output [DC5V/5.7kΩ, Active Low] (FULL)		
Remaining alarm warning output [DC5V/5.7kΩ, Active Low] (ALARM FULL)		
Series recording connecting input [DC5V/5.7kΩ, Active Low] (SERIES IN)		
Series recording connecting output [Open collector/1kΩ, Low Level active (max. 25 mA)] (SERIES OUT)		
External timer input [Zero voltage contact] (EXIT TIMER IN)		
NON REC Output [DC5V/5.7kΩ, Active Low] (NON REC OUT)		

1AC6P1P3018--
L8HBM/XE (0206KP)



SANYO Electric Co., Ltd.