

Grizzly *Industrial, Inc.*®

WET SHARPENER

MODEL H6069

INSTRUCTION MANUAL



COPYRIGHT © APRIL, 2004 BY GRIZZLY INDUSTRIAL, INC.

WARNING: NO PORTION OF THIS MANUAL MAY BE REPRODUCED IN ANY SHAPE OR FORM WITHOUT THE WRITTEN APPROVAL OF GRIZZLY INDUSTRIAL, INC.

#6234 PRINTED IN CHINA

WARNING

Some dust created by power sanding, sawing, grinding, drilling, and other construction activities contains chemicals known to the State of California to cause cancer, birth defects or other reproductive harm. Some examples of these chemicals are:

- Lead from lead-based paints.
- Crystalline silica from bricks, cement, and other masonry products.
- Arsenic and chromium from chemically treated lumber.

Your risk from these exposures varies, depending on how often you do this type of work. To reduce your exposure to these chemicals: work in a well ventilated area, and work with approved safety equipment, such as those dust masks that are specially designed to filter out microscopic particles.

SAFETY

WARNING

For Your Own Safety Read Instruction Manual Before Operating This Equipment

The purpose of safety symbols is to attract your attention to possible hazardous conditions. This manual uses a series of symbols and signal words which are intended to convey the level of importance of the safety messages. The progression of symbols is described below. Remember that safety messages by themselves do not eliminate danger and are not a substitute for proper accident prevention measures.

DANGER

Indicates an imminently hazardous situation which, if not avoided, **WILL** result in death or serious injury.

WARNING

Indicates a potentially hazardous situation which, if not avoided, **COULD** result in death or serious injury.

CAUTION

Indicates a potentially hazardous situation which, if not avoided, **MAY** result in minor or moderate injury. It may also be used to alert against unsafe practices.

NOTICE

This symbol is used to alert the user to useful information about proper operation of the equipment.

WARNING

Safety Instructions For Power Tools

- KEEP ALL SAFETY DEVICES IN PLACE** and in working order.
- REMOVE ADJUSTING KEYS AND WRENCHES.** Form habit of checking to see that keys and adjusting wrenches are removed from tool before turning on.
- KEEP WORK AREA CLEAN.** Cluttered areas and benches invite accidents.
- DON'T USE IN DANGEROUS ENVIRONMENT.** Don't use power tools in damp or wet locations, or where any flammable or noxious fumes may exist. Keep work area well lighted.
- KEEP CHILDREN AND VISITORS AWAY.** All children and visitors should be kept at a safe distance from work area.
- MAKE WORK SHOP CHILD PROOF** with padlocks, master switches, or by removing starter keys.
- DON'T FORCE TOOL.** It will do the job better and safer at the rate for which it was designed.
- USE RIGHT TOOL.** Don't force tool or attachment to do a job for which it was not designed.

WARNING

Safety Instructions For Power Tools

- 9. USE PROPER EXTENSION CORD** for the tool. Make sure your extension cord is in good condition. Conductor size should be in accordance with the chart below. The amperage rating should be listed on the motor or tool nameplate. An undersized cord will cause a drop in line voltage resulting in loss of power and overheating. Your extension cord must also contain a ground wire and plug pin. Always repair or replace extension cords if they become damaged.

Minimum Gauge for Extension Cords

AMP RATING	LENGTH		
	25ft	50ft	100ft
0-6	18	16	16
7-10	18	16	14
11-12	16	16	14
13-16	14	12	12
17-20	12	12	10
21-30	10	10	No

- 10. WEAR PROPER APPAREL.** Do not wear loose clothing, gloves, neckties, rings, bracelets, or other jewelry which may get caught in moving parts. Non-slip footwear is recommended. Wear protective hair covering to contain long hair.
- 11. ALWAYS USE SAFETY GLASSES.** Everyday eyeglasses only have impact resistant lenses, they are NOT safety glasses.
- 12. SECURE WORK.** Use clamps or a vise to hold work when practical. It's safer than using your hand and frees both hands to operate tool.
- 13. DON'T OVERREACH.** Keep proper footing and balance at all times.
- 14. MAINTAIN TOOLS WITH CARE.** Keep tools sharp and clean for best and safest performance. Follow instructions for lubricating and changing accessories.
- 15. DISCONNECT TOOLS** before servicing and changing accessories, such as blades, bits, cutters, and the like.
- 16. REDUCE THE RISK OF UNINTENTIONAL STARTING.** Make sure switch is in off position before plugging in.
- 17. USE RECOMMENDED ACCESSORIES.** Consult the owner's manual for recommended accessories. The use of improper accessories may cause risk of injury.
- 18. CHECK DAMAGED PARTS.** Before further use of the tool, a guard or other part that is damaged should be carefully checked to determine that it will operate properly and perform its intended function. Check for alignment of moving parts, binding of moving parts, breakage of parts, mounting, and any other conditions that may affect its operation. A guard or other part that is damaged should be properly repaired or replaced.

WARNING

Additional Safety Instructions For Wet Sharpeners

1. **READ THIS MANUAL.** This manual contains proper operating instructions for this machine.
2. **DO NOT** jam the workpiece against the sharpening surface. Firmly grasp the workpiece in both hands and ease it against the sharpener using light pressure.
3. **DO NOT** wear loose clothing while operating this machine. Roll up or button sleeves at the cuff.
4. **DO NOT** place hands near, or in contact with, sharpening surfaces during operation.
5. **GRIP THE WORKPIECE WITH BOTH HANDS.**
6. **PERFORM** machine inspections and maintenance service promptly as required.
7. **NEVER** leave the machine running unattended.
8. **REPLACE** sharpening wheel as needed.
9. **NEVER** sharpen more than one item at a time.
10. **ALWAYS** disconnect the machine from the power source before changing the sharpening wheel or adding water to the reservoir.
11. **ALWAYS** test run the machine before starting any work.

WARNING



Operating this sharpener can propel objects into the air, causing immediate eye damage. To protect yourself, always wear American National Standards Institute (ANSI) approved safety glasses or goggles when operating this equipment.

CAUTION

No list of safety guidelines can be complete. Every shop environment is different. Always consider safety first, as it applies to your individual working conditions. Use this and other machinery with caution and respect. Failure to do so could result in serious personal injury, damage to equipment or poor work results.

INTRODUCTION

Foreword

We are proud to offer the Grizzly Model H6069 Wet Sharpener. This model is part of a growing Grizzly family of fine power tools. When used according to the guidelines set forth in this manual, you can expect years of trouble-free, enjoyable operation and proof of Grizzly's commitment to customer satisfaction.

The Model H6069 features a slow 170 RPM wheel speed to prevent overheating a workpiece, a built in water reservoir, and a forward and reverse switch.

It is our pleasure to provide this manual with the Model H6069. It was written to encourage safety considerations and guide you through general operating procedures and maintenance. This manual represents our effort to produce the best documentation possible.

The specifications, details, and photographs in this manual represent the Model H6069 as supplied when the manual was prepared. However, owing to Grizzly's policy of continuous improvement, changes may be made at any time with no obligation on the part of Grizzly.

Machine Data

Motor 110V, 1760 RPM
Amp Draw 0.3 Amps
Wheel Speed 170 RPM
Net Weight 8 lbs.

Contact Info

If you have any comments regarding this manual, please write to us at the following address:

Grizzly Industrial, Inc.
C/O Technical Documentation
P.O. Box 2069
Bellingham, WA 98227-2069

Most importantly, we stand behind our tools. If you have any service questions or parts requests, please call or write us at the location listed below.

Grizzly Industrial, Inc.
1203 Lycoming Mall Circle
Muncy, PA 17756
Phone: (570) 546-9663
Fax: (800) 438-5901
E-Mail: techsupport@grizzly.com
Web Site: <http://www.grizzly.com>



WARNING

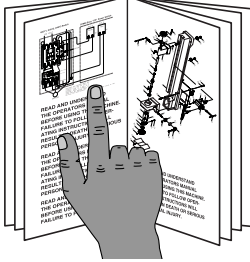

Read the manual before operation. Become familiar with this machine, its safety instructions, and its operation before beginning any work. Serious personal injury may result if safety or operational information is not understood or followed.

FEATURES & CONTROLS

The set up and operation instructions will be easier to understand if you are familiar with the basic features of the Model H6069 Wet Sharpener. Match up the feature list below with the letters in **Figure 1** to identify the wet sander feature locations.

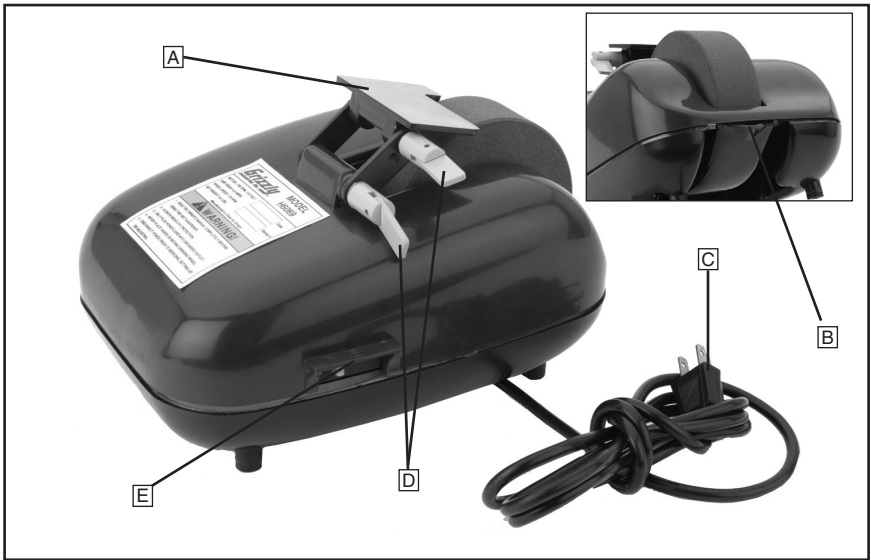

Figure 1. Model H6069 features and controls.

- A. Tool rest
- B. Drain trough
- C. Power cord
- D. Adjustment lock handles
- E. Forward/Off/Reverse switch

OPERATIONS

Filling Reservoir



! WARNING

Reduce the risk of electrocution by keeping all connections dry and off the ground. **DO NOT** touch plugs with wet hands. Failure to follow these warning could result in serious injury.

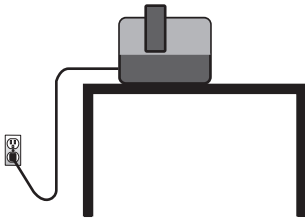

! WARNING

Be sure the cord is positioned with a “drip loop” below the level of the outlet as shown above. This prevents water from running down the cord and into the outlet. Instead the water will drip to the floor at the “drip loop” on the cord.

To fill the water reservoir:

1. **DISCONNECT FROM THE POWER SOURCE.**
2. Loosen the tool rest adjustment lock handles and move the tool rest away from the sharpening stone.
3. Fill the water reservoir. See **Figure 2**

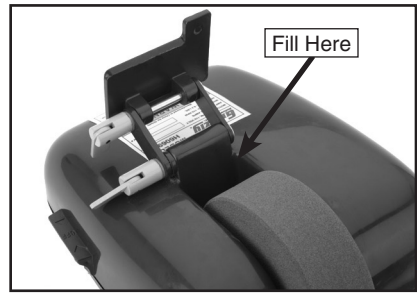

Figure 2. Tool rest moved away from sharpening wheel.

4. With dry hands and a dry plug, connect the wet sharpener into the power source.
5. Run the wet sharpener for one minute to properly wet the stone.
6. With dry hands and a dry plug, disconnect the saw from the power source.
7. Refill the water reservoir until full and return the tool rest to the desired location.

NOTE—It is important to keep the wheel well lubricated while sharpening. Unplug and refill machine as needed to maintain an appropriate water level.

Tool Rest

Equipped with an adjustable tool rest, the Model H6069 enables precise control over the sharpening operation. **Figure 3** shows the height and angle adjustment lock handles for the tool rest.

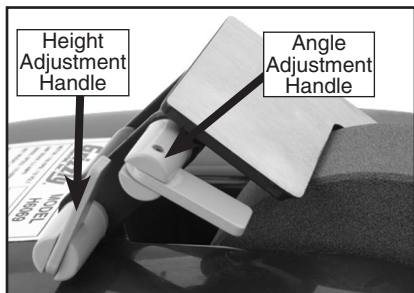

Figure 3. Adjustment lock handles.

Adjusting the tool rest:

1. Loosen the height adjustment lock handle and move the tool rest to the desired height.
2. Tighten the height adjustment lock handle.
3. Apply **Steps 1 & 2** to the angle adjustment lock handle to fine tune your sharpening angle.

WARNING



Operating this sharpener can propel objects into the air, causing immediate eye damage. To protect yourself, always wear American National Standards Institute (ANSI) approved safety glasses or goggles when operating this equipment.

Sharpening

The Model H6069 Wet Sharpener, if properly used, will help you maintain the quality and life of your tools by keeping them sharp. Typical items you may sharpen with the wet sharpener include knives, chisels, planer blades, lathe tools and any other items around your shop that need to maintain a sharp edge.

We recommend practicing with a tool of low personal value to get the feel of sharpening with this machine.

Using the wet sharpener:

1. Turn the sharpener *ON* with the wheel rotating towards you.
2. Set the tool rest at the desired angle.
3. Place the blade on the tool rest. Using light pressure, press the blade against the wheel and slowly move side to side. **Figure 4**



Figure 4. Correct positioning on tool rest.

4. If you are sharpening a double edged tool such as a knife, turn the blade around and sharpen the opposite side. *NOTE—If the tool you are sharpening has a one-sided edge such as a chisel or planer blade, DO NOT follow this step.*

MAINTENANCE

Reservoir Rinsing

With use, the water reservoir will begin to fill with ground material from the objects being sharpened and wheel particles removed during the sharpening process. Keep the water reservoir clean and free of residue build up.

To rinse the water reservoir:

1. **UNPLUG THE SHARPENER FROM THE POWER SOURCE.**
2. Tilt the sharpener to drain any water in the reservoir through the drain trough on the back of the sharpener.
3. Move the tool rest away from the grinding wheel.
4. Fill the reservoir with fresh water and empty from the drain trough. Repeat until clean.



WARNING

Reduce the risk of electrocution by keeping all connections dry and off the ground. **DO NOT** touch plugs with wet hands. Failure to follow these warning could result in serious injury.

NOTES

H6069 Wet Sharpener Parts Breakdown

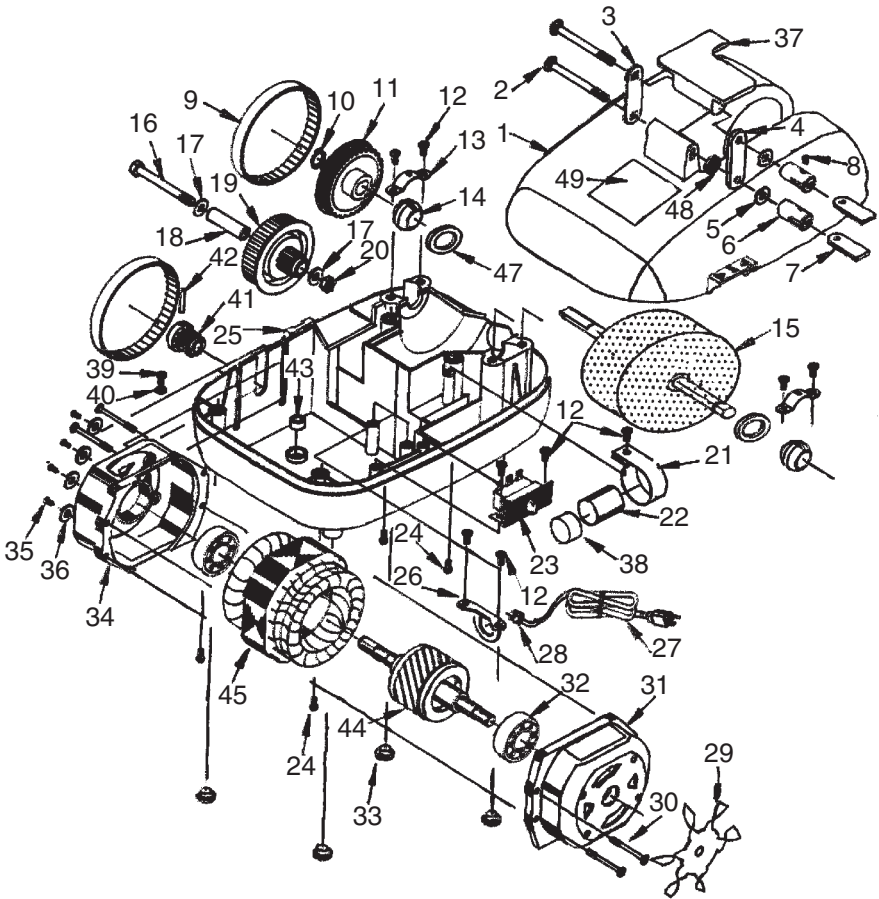

REF	PART #	DESCRIPTION
1	PH6069001	UPPER HOUSING
2	PCB14	CARRIAGE BOLT #10-32 X 3/8"
3	PH6069003	LEFT SUPPORT
4	PH6069004	RIGHT SUPPORT
5	PH6069005	PLASTIC WASHER 3/16"
6	PH6069006	LOCK HANDLE NUT 3/16-32
7	PH6069007	LOCK HANDLE LEVER
8	PRP61M	ROLL PIN 3 X 12
9	PH6069009	POWER BELT 3/8" X 10"
10	PR16	EXT RETAINING RING
11	PH6069011	WHEEL GEAR

Model H6069

REF	PART #	DESCRIPTION
12	PHTEK29	TAP SCREW #5 X 1/2"
13	PH6069013	BEARING HOLDER
14	PH6069014	PLAIN BEARING 22MM X 11MM
15	PH6069015	WHEEL SHAFT ASSEMBLY
16	PS86M	PHLP HD SCR M6-1 X 55
17	PW03M	FLAT WASHER 6MM
18	PH6069018	AXLE SLEEVE
19	PH6069019	REDUCTION GEAR
20	PLN03M	LOCK NUT M6-1
21	PH6069021	CAPACITOR HOLDER
22	PC006	CAPACITOR 6MFD 250V
23	PH6069023	POWER SWITCH
24	PHTEK6M	TAP SCREW M4 X 16
25	PH6069025	LOWER HOUSING
26	PH6069026	CLAMPING PLATE
27	PH6069027	POWER CORD
28	PH6069028	STRAIN RELIEF
29	PH6069029	FAN
30	PS25M	PHLP HD SCR M4-.7 X 35
31	PH6069031	RIGHT MOTOR HOUSING
32	P6200	BALL BEARING 6200
33	PH6069033	FOOT PADS
34	PH6069034	LEFT MOTOR HOUSING
35	PB97M	HEX BOLT M4-.7 X 12
36	PW05M	WASHER 4MM
37	PH6069037	TOOL REST
38	PH6069038	CAPACITOR SLEEVE
39	PS17M	PHLP HD SCR M4-.7 X 6
40	PTLW11M	INT TOOTH WASHER 4MM
41	PH6069041	MOTOR GEAR
42	PH6069042	LINCHPIN
43	PH6069043	RUBBER WASHER
44	PH6069044	ROTOR
45	PH6069045	STATOR
47	PH6069047	BEARING WASHER 11MM
48	PH6069048	TABLE FIXING PAD
49	PH6069049	MACHINE ID LABEL

WARRANTY AND RETURNS

Grizzly Industrial, Inc. warrants every product it sells for a period of **1 year** to the original purchaser from the date of purchase. This warranty does not apply to defects due directly or indirectly to misuse, abuse, negligence, accidents, repairs or alterations or lack of maintenance. This is Grizzly's sole written warranty and any and all warranties that may be implied by law, including any merchantability or fitness, for any particular purpose, are hereby limited to the duration of this written warranty. We do not warrant or represent that the merchandise complies with the provisions of any law or acts unless the manufacturer so warrants. In no event shall Grizzly's liability under this warranty exceed the purchase price paid for the product and any legal actions brought against Grizzly shall be tried in the State of Washington, County of Whatcom.

We shall in no event be liable for death, injuries to persons or property or for incidental, contingent, special, or consequential damages arising from the use of our products.

To take advantage of this warranty, contact us by mail or phone and give us all the details. We will then issue you a "Return Authorization Number," which must be clearly posted on the outside as well as the inside of the carton. We will not accept any item back without this number. Proof of purchase must accompany the merchandise.

The manufacturers reserve the right to change specifications at any time because they constantly strive to achieve better quality equipment. We make every effort to ensure that our products meet high quality and durability standards and we hope you never need to use this warranty.

Please feel free to write or call us if you have any questions about the machine or the manual.

Grizzly Industrial, Inc.
1203 Lycoming Mall Circle
Muncy, PA 17756
Phone: (570) 546-9663
Fax: (800) 438-5901

E-Mail:
techsupport@grizzly.com

Web Site: <http://www.grizzly.com>

Thank you again for your business and continued support. We hope to serve you again soon!

WARRANTY CARD

Name _____

Street _____

City _____ State _____ Zip _____

Phone Number _____ E-Mail _____ Serial # _____

- How did you learn about us?
 Advertisement Friend
 Catalog Card Deck
 World Wide Web
 Other _____
- What is your annual household income?
 \$20,000-\$29,999 \$60,000-\$69,999
 \$30,000-\$39,999 \$70,000-\$79,999
 \$40,000-\$49,999 \$80,000-\$89,999
 \$50,000-\$59,999 \$90,000 +
- What is your age group?
 20-29 50-59
 30-39 60-69
 40-49 70 +
- How long have you been a woodworker?
 0 - 2 Years 8 - 20 Years
 2 - 8 Years 20+ Years
- How would you rank your woodworking skills?
 Simple Advanced
 Intermediate Master Craftsman
- What stationary woodworking tools do you own?
Check all that apply.
 Air Compressor Panel Saw
 Band Saw Planer
 Drill Press Power Feeder
 Drum Sander Radial Arm Saw
 Dust Collector Shaper
 Spindle Sander Jointer
 Table Saw Lathe
 Mortiser Wide Belt Sander
 Horiz.Boring Machine
 Vacuum Veneer Press
 Other _____
- How many of your woodworking machines are Grizzly? _____
- Which benchtop tools do you own? Check all that apply.
 1"x42" Belt Sander 6" - 8" Grinder
 5" - 8" Drill Press Mini Lathe
 8" Table Saw 8" - 10" Bandsaw
 Scroll Saw Disc/Belt Sander
 Spindle/Belt Sander Mini Jointer
 10"-12"Thickness Planer
- Other _____
- How many of the machines checked above are Grizzly? _____
- Which portable/hand held power tools do you own?
Check all that apply.
 Belt Sander Orbital Sander
 Biscuit Joiner Palm Sander
 Circular Saw Portable Planer
 Detail Sander Saber Saw
 Drill/Driver Reciprocating Saw
 Miter Saw Router
Other _____
- What machines/supplies would you like Grizzly Industrial to carry?

- What new accessories would you like Grizzly Industrial to carry?

- What other companies do you purchase your tools and supplies from?

- Do you think your purchase represents good value?
 Yes No
- Would you recommend Grizzly to a friend?
 Yes No
- Would you allow us to use your name as a reference for Grizzly customers in your area? **Note: We never use names more than three times.**
 Yes No
- Comments: _____

Send a Grizzly Catalog to a friend:

Name _____
Street _____
City _____ State _____ Zip _____

FOLD ALONG DOTTED LINE

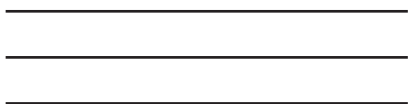

Place
Stamp
Here



GRIZZLY INDUSTRIAL, INC.
P.O. BOX 2069
BELLINGHAM, WA 98227-2069



TAPE ALONG EDGES--PLEASE DO NOT STAPLE