

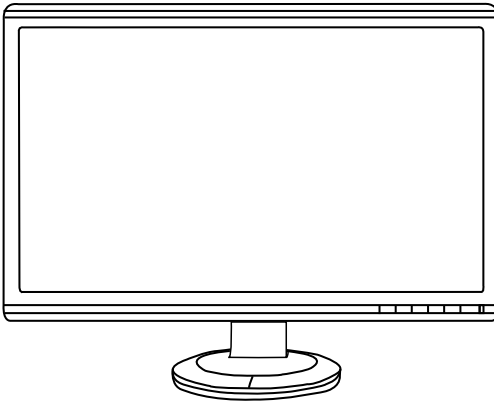

April 2010

# ASUS VG236 Series LCD Monitor

## User Guide



# Table of contents

- Notices..... iii**
- Safety information ..... iv**
- Care & Cleaning..... v**
- 1.1 Welcome! ..... 1-1**
- 1.2 Package contents..... 1-1**
- 1.3 Adjusting the monitor..... 1-2**
- 1.4 Connect cables..... 1-3**
- 1.5 Monitor introduction ..... 1-4**
- 2.1 Detaching the arm/stand  
(for VESA wall mount) .....2-1**
- 2.2 Assembling the monitor base..... 2-1**
- 3.1 OSD (On-Screen Display) menu ..... 3-1**
- 3.2 Specifications summary..... 3-4**
- 3.3 Troubleshooting (FAQ)..... 3-5**
- 3.4 Supported timing list .....3-6**

Copyright © 2010 ASUSTeK COMPUTER INC. All Rights Reserved.

No part of this manual, including the products and software described in it, may be reproduced, transmitted, transcribed, stored in a retrieval system, or translated into any language in any form or by any means, except documentation kept by the purchaser for backup purposes, without the express written permission of ASUSTeK COMPUTER INC. ("ASUS").

Product warranty or service will not be extended if: (1) the product is repaired, modified or altered, unless such repair, modification or alteration is authorized in writing by ASUS; or (2) the serial number of the product is defaced or missing.

ASUS PROVIDES THIS MANUAL "AS IS" WITHOUT WARRANTY OF ANY KIND, EITHER EXPRESS OR IMPLIED, INCLUDING BUT NOT LIMITED TO THE IMPLIED WARRANTIES OR CONDITIONS OF MERCHANTABILITY OR FITNESS FOR A PARTICULAR PURPOSE. IN NO EVENT SHALL ASUS, ITS DIRECTORS, OFFICERS, EMPLOYEES OR AGENTS BE LIABLE FOR ANY INDIRECT, SPECIAL, INCIDENTAL, OR CONSEQUENTIAL DAMAGES (INCLUDING DAMAGES FOR LOSS OF PROFITS, LOSS OF BUSINESS, LOSS OF USE OR DATA, INTERRUPTION OF BUSINESS AND THE LIKE), EVEN IF ASUS HAS BEEN ADVISED OF THE POSSIBILITY OF SUCH DAMAGES ARISING FROM ANY DEFECT OR ERROR IN THIS MANUAL OR PRODUCT.

SPECIFICATIONS AND INFORMATION CONTAINED IN THIS MANUAL ARE FURNISHED FOR INFORMATIONAL USE ONLY, AND ARE SUBJECT TO CHANGE AT ANY TIME WITHOUT NOTICE, AND SHOULD NOT BE CONSTRUED AS A COMMITMENT BY ASUS. ASUS ASSUMES NO RESPONSIBILITY OR LIABILITY FOR ANY ERRORS OR INACCURACIES THAT MAY APPEAR IN THIS MANUAL, INCLUDING THE PRODUCTS AND SOFTWARE DESCRIBED IN IT.

Products and corporate names appearing in this manual may or may not be registered trademarks or copyrights of their respective companies, and are used only for identification or explanation and to the owners' benefit, without intent to infringe.

# Notices

## Federal Communications Commission Statement

This device complies with Part 15 of the FCC Rules. Operation is subject to the following two conditions:

- This device may not cause harmful interference, and
- This device must accept any interference received including interference that may cause undesired operation.

This equipment has been tested and found to comply with the limits for a Class B digital device, pursuant to Part 15 of the FCC Rules. These limits are designed to provide reasonable protection against harmful interference in a residential installation. This equipment generates, uses and can radiate radio frequency energy and, if not installed and used in accordance with manufacturer's instructions, may cause harmful interference to radio communications. However, there is no guarantee that interference will not occur in a particular installation. If this equipment does cause harmful interference to radio or television reception, which can be determined by turning the equipment off and on, the user is encouraged to try to correct the interference by one or more of the following measures:

- Reorient or relocate the receiving antenna.
- Increase the separation between the equipment and receiver.
- Connect the equipment to an outlet on a circuit different from that to which the receiver is connected.
- Consult the dealer or an experienced radio/TV technician for help.



As an Energy Star® Partner, our company has determined that this product meets the Energy Star® guidelines for energy efficiency.

## Canadian Department of Communications Statement

This digital apparatus does not exceed the Class B limits for radio noise emissions from digital apparatus set out in the Radio Interference Regulations of the Canadian Department of Communications.

This class B digital apparatus complies with Canadian ICES-003.

## Safety information

- Before setting up the monitor, carefully read all the documentation that came with the package.
- To prevent fire or shock hazard, never expose the monitor to rain or moisture.
- Never try to open the monitor cabinet. The dangerous high voltages inside the monitor may result in serious physical injury.
- If the power supply is broken, do not try to fix it by yourself. Contact a qualified service technician or your retailer.
- Before using the product, make sure all cables are correctly connected and the power cables are not damaged. If you detect any damage, contact your dealer immediately.
- Slots and openings on the back or top of the cabinet are provided for ventilation. Do not block these slots. Never place this product near or over a radiator or heat source unless proper ventilation is provided.
- The monitor should be operated only from the type of power source indicated on the label. If you are not sure of the type of power supply to your home, consult your dealer or local power company.
- Use the appropriate power plug which complies with your local power standard.
- Do not overload power strips and extension cords. Overloading can result in fire or electric shock.
- Avoid dust, humidity, and temperature extremes. Do not place the monitor in any area where it may become wet. Place the monitor on a stable surface.
- Unplug the unit during a lightning storm or if it will not be used for a long period of time. This will protect the monitor from damage due to power surges.
- Never push objects or spill liquid of any kind into the slots on the monitor cabinet.
- To ensure satisfactory operation, use the monitor only with UL listed computers which have appropriate configured receptacles marked between 100-240V AC.
- If you encounter technical problems with the monitor, contact a qualified service technician or your retailer.

## Care & Cleaning

- Before you lift or reposition your monitor, it is better to disconnect the cables and power cord. Follow the correct lifting techniques when positioning the monitor. When lifting or carrying the monitor, grasp the edges of the monitor. Do not lift the display by the stand or the cord.
- Cleaning. Turn your monitor off and unplug the power cord. Clean the monitor surface with a lint-free, non-abrasive cloth. Stubborn stains may be removed with a cloth dampened with mild cleaner.
- Avoid using a cleaner containing alcohol or acetone. Use a cleaner intended for use with the LCD. Never spray cleaner directly on the screen, as it may drip inside the monitor and cause an electric shock.

### The following symptoms are normal with the monitor:

- The screen may flicker during the initial use due to the nature of the fluorescent light. Turn off the Power Switch and turn it on again to make sure that the flicker disappears.
- You may find slightly uneven brightness on the screen depending on the desktop pattern you use.
- When the same image is displayed for hours, an afterimage of the previous screen may remain after switching the image. The screen will recover slowly or you can turn off the Power Switch for hours.
- When the screen becomes black or flashes, or cannot work anymore, contact your dealer or service center to fix it. Do not repair the screen by yourself!

### Conventions used in this guide



**WARNING:** Information to prevent injury to yourself when trying to complete a task.



**CAUTION:** Information to prevent damage to the components when trying to complete a task.



**IMPORTANT:** Information that you **MUST** follow to complete a task.



**NOTE:** Tips and additional information to aid in completing a task.

## **Where to find more information**

Refer to the following sources for additional information and for product and software updates.

### **1. ASUS websites**

The ASUS websites worldwide provide updated information on ASUS hardware and software products. Refer to <http://www.asus.com>

### **2. Optional documentation**

Your product package may include optional documentation that may have been added by your dealer. These documents are not part of the standard package.

## 1.1 Welcome!

Thank you for purchasing the ASUS® VG236 Series LCD monitor!

The latest widescreen LCD monitor from ASUS provides a crisper, broader, and brighter display, plus a host of features that enhance your viewing experience.

With these features, you can enjoy the convenience and delightful visual experience that the VG236 Series brings you!

## 1.2 Package contents

Check your VG236 Series LCD package for the following items:

- ✓ LCD monitor
- ✓ Monitor base
- ✓ Support CD
- ✓ Quick start guide
- ✓ Power cord
- ✓ Dual-link DVI cable
- ✓ NVIDIA® 3D Vision™ kit (For VG236H only)



---

If any of the above items is damaged or missing, contact your retailer immediately.

---

### 1.3 Adjusting the monitor

- For optimal viewing, we recommend that you look at the full face of the monitor, then adjust the monitor to the angle that is most comfortable for you.
- Hold the stand to prevent the monitor from falling when you change its angle.
- You can tilt the monitor's from  $-5^{\circ}$  to  $15^{\circ}$ , swivel from left-to-right for  $150^{\circ}$ , and lift the monitor's height for about 100mm.

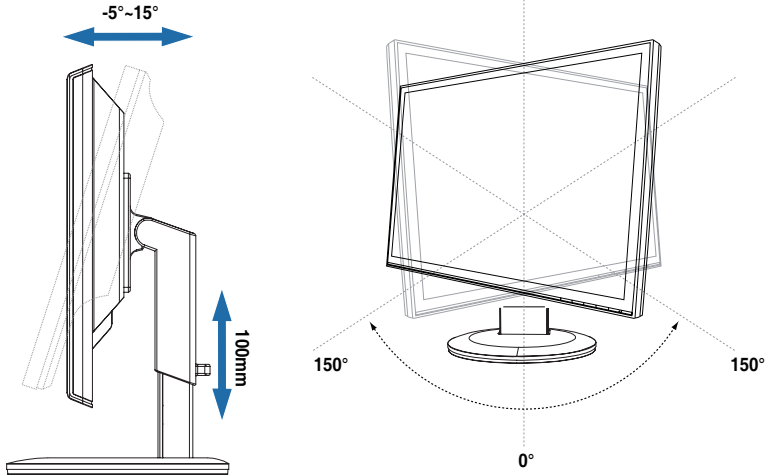



## 1.4 Connect cables

Connect cables which you need

### 1.4.1 Rear of the LCD monitor

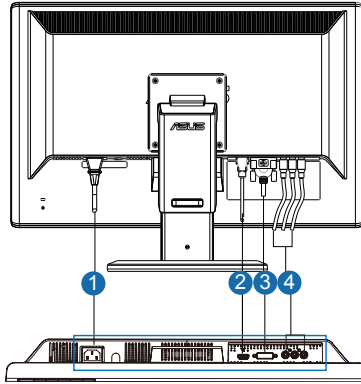

1	AC-IN port
2	HDMI-IN port
3	DVI port (support NVIDIA® 3D Vision™)
4	YPbPr port

### 1.4.2 To connect the Dual-link DVI cable

Connect one end of the Dual-link DVI cable to the DVI port of the monitor and the other end to the DVI port of a computer. You can use this cable only if your computer has a Dual-link DVI compliance graphics card that is either integrated or installed.



---

The 3D feature is only supported with the monitor's DVI port.

---





Notice: To support 3D Vision, please make sure the bundled Dual-link DVI cable is properly connected the monitor and a 3D Vision compatible graphics card. The 3D feature is not supported with HDMI or YPbPr connection.

---

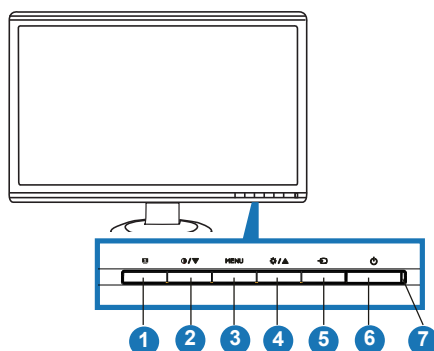
## 1.5 Monitor introduction

### 1.5.1 Front of the LCD monitor



1.  Button:
  - Use this Splendid™ hotkey to switch from five video preset modes (Game Mode, Night View Mode, Scenery Mode, Standard Mode, Theater Mode) with SPLENDID™ Video Intelligence Technology.
  - Exit the OSD menu or go back to the previous menu as the OSD menu is active.
2.  Button:
  - Press this button to decrease the value of the function selected or move to the next function.
  - This is also a hotkey for Contrast adjustment.
3. MENU Button:
  - Press this button to enter/select the icon (function) highlighted while the OSD menu is activated.
4.  Button:
  - Press this button to increase the value of the function selected or move to the previous function.
  - This is also a hotkey for Brightness adjustment.
5.  Input Select Button
  - Use this hotkey to switch from DVI, HDMI and YPbPr input signals.
6.  Power button
  - Press this button to turn the monitor on/off.

## 7. Power indicator

Status	Description
Blue	ON
Amber	Standby mode
OFF	OFF



---

Splendid, Contrast and Brightness adjustment functions will be temporarily disabled while 3D function is activated.

---

### 1.5.2 Experiencing 3D Virtual Effects

ASUS VG236 is a 3D Vision ready LCD monitor which supports PC timing up to 1920x1080@120Hz. To experience fully immersive stereoscopic 3D virtual effects with VG236; you require NVIDIA® 3D Vision™ kit (shutter glasses, IR emitter), a compatible NVIDIA-GPU graphics card and a computer with Microsoft® Windows® Vista or Windows® 7 installed. Please visit NVIDIA website (<http://www.nvidia.com/>) for more information.

## 2.1 Detaching the arm/stand (for VESA wall mount)

The detachable stand of the VG236 Series LCD monitor is specially designed for VESA wall mount.

To detach the arm/stand:

1. Lower the monitor to its lowest height, and then inset the monitor height adjustment lock.
2. Have the front of the monitor face down on a table.
3. Use a screwdriver to remove the two screws on the VESA cover, the slide out the arm/base to detach it from the monitor.



- We recommend that you cover the table surface with soft cloth to prevent damage to the monitor.
  - Hold the stand of the monitor when you remove the screws.
- 



---

The VESA wall mount kit (100 mm x 100 mm) is purchased separately.

For use only with UL Listed Wall Mount Bracket with minimum weight/load 7.4 Kg (Screw size: 4mm x 12 mm)

---

## 2.2 Assembling the monitor base

To assemble the monitor base:

1. Have the monitor base place on a flat table.
2. Use the screw, lock the base to the arm according to the below drawing.
3. Remove the monitor height adjustment lock.

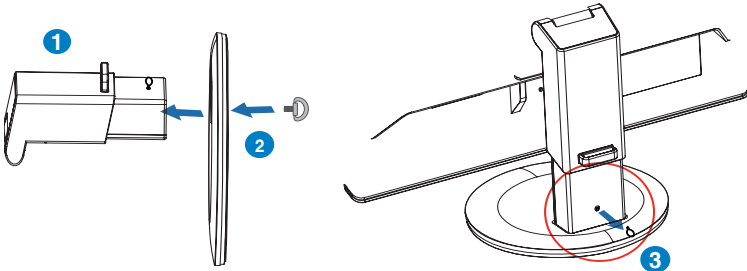

The monitor height adjustment lock should **NEVER** be removed **BEFORE** you place the monitor **VERTICALLY** on a flat surface.



# 3.1 OSD (On-Screen Display) menu

## 3.1.1 How to reconfigure

1. Press the MENU button to activate the OSD menu.

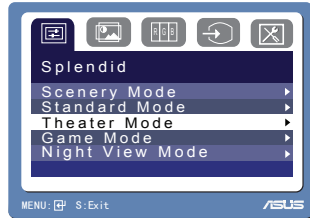

2. Press ▼ and ▲ to navigate through the functions. Highlight and activate the desired function by pressing the MENU button. If the function selected has a sub-menu, press ▼ and ▲ again to navigate through the sub-menu functions. Highlight and activate the desired sub-menu function by pressing the MENU button.
3. Press ▼ and ▲ to change the settings of the selected function.
4. To exit the OSD menu, press the **S** button. Repeat step 2 and step 3 to adjust any other function.

## 3.1.2 OSD Function Introduction

### 1. Splendid

This function contains five sub-functions you can select for your preference. Each mode has the Reset selection, allowing you to maintain your setting or return to the preset mode.

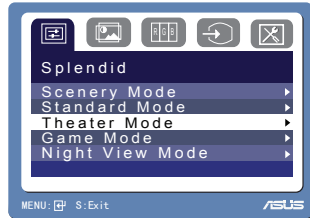

- **Scenery Mode:** best choice for scenery photo display with SPLENDID™ Video Intelligence Technology.
- **Standard Mode:** best choice for document editing with SPLENDID™ Video Intelligence Technology.
- **Theater Mode:** best choice for movie with SPLENDID™ Video Intelligence Technology.
- **Game Mode:** best choice for game playing with SPLENDID™ Video Intelligence Technology.
- **Night View Mode:** best choice for dark-scene game or movie with SPLENDID™ Video Intelligence Technology.



- In the Standard Mode, the **Saturation** and ASCR functions are not user-configurable.
- In the other modes, the sRGB function is not user-configurable.

## 2. Image

You can adjust Brightness, Contrast, ASCR, Trace Free, Sharpness, and Saturation from this main function.



- Brightness: the adjusting range is from 0 to 100. ✨ is a hotkey to activate this function.
- Contrast: the adjusting range is from 0 to 100. ● is a hotkey to activate this function.
- ASCR: Select YES or NO to enable or disable dynamic contrast ratio function.
- Trace Free: to speed up the response time by Trace Free Technology.
- Sharpness: the adjusting range is from 0 to 100.
- Saturation: the adjusting range is from 0 to 100.

## 3. Color

Select the image color you like from this function.

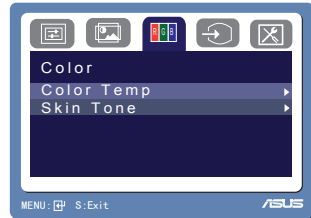

- Color Temp.: contains five color modes including Cool, Normal, Warm, sRGB, and User Mode.
- Skin Tone: contains three color modes including Reddish, Natural, and Yellowish.



---

In the User mode, colors of R (Red), G (Green), and B (Blue) are user configurable; the adjusting range is from 0 to 100.

---

#### 4. Input Select

In this function, you can select an input source among DVI, HDMI, and YPbPr.

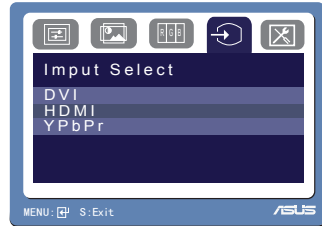

#### 5. System Setup

Allow you to adjust the system.

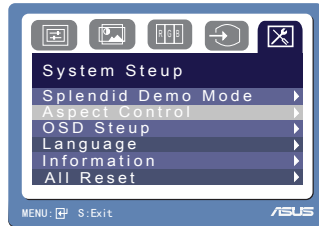

- Splendid Demo Mode: "Yes" allows you to activate Splendid Demo mode.
- Aspect Control: adjusts aspect ratio among "Full", "4:3", and "OverScan" (For HDMI and YPbPr modes only).
- OSD Setup: adjusts "H-Position" (horizontal position) and "V-Position" (vertical position), and "Transparency" of the OSD. The adjusting range is from 0 to 100. In the "OSD Timeout" selection, you can adjust the OSD timeout from 10 to 120 seconds.
- Language: there are eleven languages for your selection, including English, German, Italian, French, Dutch, Spanish, Russian, Traditional Chinese, Simplified Chinese, Japanese, and Korean.
- Information: shows the monitor information.
- All Reset: "Yes" allows you to revert to the preset mode.



---

All Splendid, Image and Color adjustment functions will be disabled for most optimized video performance while 3D function is activated

---



## 3.2 Specifications summary

Model	VG236H/HE
Panel Size	23"W (58.4 cm)
True Resolution	1920x1080 (up to 120Hz)
Brightness (Max.)	400cd/m <sup>2</sup>
Intrinsic Contrast Ratio (Max.)	1000:1
ASUS Smart Contrast Ratio (ASCR)	100,000:1
Viewing Angle (CR=10)	170°(H) ; 160°(V)
Color Saturation (NTSC)	72%
Display Colors	16.7 M
Response Time	2ms (Gray to Gray)
NVIDIA® 3D VISION™ Compliance	Yes (Ready for 3D PC games and videos playback)
Trace Free II Technology	Yes
Splendid™ Video Intelligence Tech.	Yes (5 video preset mode selections)
Aspect Control Technology	Yes (Full and 4:3 selections)
PC input	DVI (support NVIDIA 3D Vision)
Video input	HDMI, YPbPr
Power ON	< 60W
Power Saving Mode	< 2W
Power Off Mode	< 1W
Tilt	+15° ~ -5°
VESA Wall Mounting	Yes (100mm x 100mm)
Phys. Dimension	550 x 420 x 250 mm
Box Dimension (WxHxD)	625 x 483 x 232 mm
Net Weight (Esti.)	7.0 kg
Gross Weight (Esti.)	11.1/10.3 kg
Voltage Rating	AC:100~240V (Built-in)
Accessories	Dual-Link DVI cable, Power cord, Quick start guide, Warranty card, Support CD, NVIDIA 3D Vision Kit (for VG236H only)

### 3.3 Troubleshooting (FAQ)

Problem	Possible Solution
Power LED is not ON	<ul style="list-style-type: none"> <li>• Press the  button to check if the monitor is in the ON mode.</li> <li>• Check if the power cord is properly connected to the monitor and the power outlet.</li> </ul>
The power LED lights amber and there is no screen image	<ul style="list-style-type: none"> <li>• Check if the monitor and the computer are in the ON mode.</li> <li>• Make sure the signal cable is properly connected the monitor and the computer.</li> <li>• Inspect the signal cable and make sure none of the pins are bent.</li> <li>• Connect the computer with another available monitor to check if the computer is properly working.</li> </ul>
Screen image is too light or dark	<ul style="list-style-type: none"> <li>• Adjust the Contrast and Brightness settings via OSD.</li> </ul>
Screen image bounces or a wave pattern is present in the image	<ul style="list-style-type: none"> <li>• Make sure the signal cable is properly connected to the monitor and the computer.</li> <li>• Move electrical devices that may cause electrical interference.</li> </ul>
Screen image has color defects (white does not look white)	<ul style="list-style-type: none"> <li>• Inspect the signal cable and make sure that none of the pins are bent.</li> <li>• Perform Reset via OSD.</li> <li>• Adjust the R/G/B color settings or select the Color Temperature via OSD.</li> </ul>
3D function is not well working	<ul style="list-style-type: none"> <li>• Make sure the bundled dual-link DVI cable is properly connected to the monitor and a compatible NVIDIA-GPU graphics card.</li> <li>• Make sure the NVIDIA® 3D glasses and IR emitter are properly connected to the computer via USB cables.</li> <li>• Make sure the computer was installed with Microsoft® Windows Vista or Windows 7 operating system, and required NVIDIA 3D drivers.</li> <li>• Make sure screen resolution setting is 1920x1080 at 120Hz, 110Hz or 100Hz.</li> <li>• Visit NVIDIA website (<a href="http://www.nvidia.com/">http://www.nvidia.com/</a>) for more information about system requirements, setup instructions, and PC games supported.</li> </ul>

### 3.4 Supported timing list

Resolution	Refresh Rate	Horizontal Frequency
640x480	60Hz	31.469kHz
640x480	67Hz	35kHz
640x480	72Hz	37.861kHz
640x480	75Hz	37.5kHz
640x350	70Hz	31.469kHz
720x400	70Hz	31.469kHz
800x600	56Hz	35.156kHz
800x600	60Hz	37.879kHz
800x600	72Hz	48.077kHz
800x600	75Hz	46.875kHz
832x624	75Hz	49.725kHz
848x480	60Hz	31.02kHz
1024x768	60Hz	48.363kHz
1024x768	70Hz	56.476kHz
1024x768	75Hz	60.023kHz
1152x864	75Hz	67.5kHz
1280x720	60Hz	44.444/44.772kHz
1280x720	75Hz	56.456kHz
1280x768	60Hz	47.396kHz
1280x800	60Hz	49.306/49.702kHz
1280x800	75Hz	62.795kHz
1280x960	60Hz	60kHz
1280x1024	60Hz	63.981kHz
1280x1024	75Hz	79.976kHz
1366x768	60Hz	47.7kHz
1440x900	60Hz	55.469/55.935kHz
1440x900	75Hz	70.635kHz
1680x1050	60Hz	64.674/65.29kHz
1920x1080	60Hz	66.587/67.5kHz
1920x1080* (DVI)	100Hz	113.3 kHz(2D)/113.8kHz(3D)
1920x1080* (DVI)	110Hz	125.1 kHz(2D)/125.7kHz(3D)
1920x1080* (DVI)	120Hz	137.2 kHz(2D/3D)
640X480P (HDMI/YPbPr)	59.94/60Hz	31.469/31.5kHz
720x480P (HDMI/YPbPr)	59.95/60Hz	31.469/31.5kHz
720x576P (HDMI/YPbPr)	50Hz	31.25kHz
1280x720P (HDMI/YPbPr)	50Hz	37.5kHz
1280x720P (HDMI/YPbPr)	59.94/60Hz	44.955/45kHz
1920x1080i (HDMI/YPbPr)	50Hz	28.125kHz
1920x1080i (HDMI/YPbPr)	59.94/60Hz	33.716/33.75
1920x1080P (HDMI/YPbPr)	50Hz	56.25kHz
1920x1080P (HDMI/YPbPr)	59.94/60Hz	67.433/67.5kHz

**Note:** You must select one of the “\*” timings for enabling 3D feature with a compatible NVIDIA-GPU graphics card via Dual-link DVI cable connection.