

Installation and Operations Manual

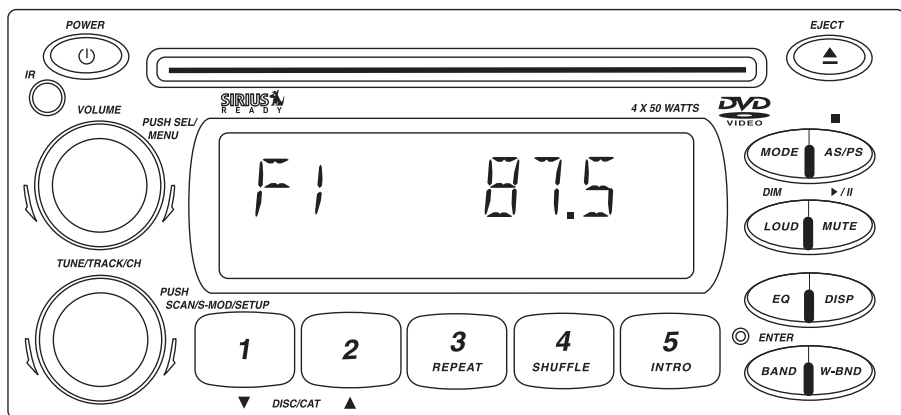

M9900DVDS AM / FM / WB and DVD / CD Stereo Receiver



Introduction

Your new Sirius ready in-dash entertainment system has been designed for many years of listening pleasure. Take a moment to read through this manual and become familiar with the operations and features.

It is advisable to keep this manual in your vehicle ready for reference. We hope the experience with your new mobile entertainment system is a pleasurable one. Be sure to fill out and send in your warranty card. In the unlikely event that your system will need service during the warranty period, you will need to be registered to receive the full benefits of warranty repair.

Features

- Compatible with PAL and NTSC Systems, this player can play discs recorded in either PAL or NTSC format.
- CD, DVD, CD-R, CD-RW, MP3 Compatible.
- L/R stereo analog audio outputs connection to existing head unit auxiliary inputs. Video output is composite video.
- Supplied Remote Features: multi-language audio-track/subtitle, multi-angle, plus all basic functions.

Safety Features

CAUTION:

MOBILE DVD PLAYER IS A CLASS I LASER PRODUCT. HOWEVER, THIS MOBILE DVD PLAYER USES A VISIBLE/INVISIBLE LASER BEAM WHICH COULD CAUSE HAZARDOUS RADIATION EXPOSURE IF DIRECTED. BE SURE TO OPERATE THE MOBILE DVD PLAYER CORRECTLY AS INSTRUCTED. USE OF CONTROLS OR ADJUSTMENTS OR PERFORMANCE OF PROCEDURES OTHER THAN THOSE SPECIFIED HEREIN MAY RESULT IN HAZARDOUS RADIATION EXPOSURE. DO NOT OPEN COVERS AND DO NOT REPAIR YOURSELF. REFER SERVICING TO QUALIFIED PERSONNEL.

WARNING:

- TO REDUCE THE RISK OF FIRE OR ELECTRIC SHOCK, DO NOT EXPOSE THIS EQUIPMENT TO RAIN OR MOISTURE.
- TO REDUCE THE RISK OF FIRE OR ELECTRIC SHOCK AND ANNOYING INTERFERENCE, USE ONLY THE RECOMMENDED ACCESSORIES.
- THIS DEVICE IS INTENDED FOR CONTINUOUS OPERATION.

This product incorporates copyright protection technology that is protected by method claims of certain U.S. patents and other intellectual property rights owned by Magnadyne Corporation and other rights owners. Use of this copyright protection technology must be authorized by Magnadyne Corporation and is intended for home and other limited viewing uses only unless otherwise authorized by Magnadyne Corporation. Reverse engineering or disassembly is prohibited.

Region Management Information:

This Mobile DVD Player is designed and manufactured to respond to the Region Management Information that is recorded on a DVD disc. If the region number described on the DVD disc does not correspond to the region number of this Mobile DVD Player, this Mobile DVD Player cannot play this disc.

Disc Notes

Disc Formats Supported by this Player:

| | |
|---|--|
|  | DVD 12 cm disc (Single-sided disc only) |
|  | Video CD 12 cm disc |
|  | CD 12 cm disc |
|  | MP3 12 cm disc |

Discs which Cannot be Played with this Player

- DVD-ROM
- DVD-R/DVD-RAM
- CDV
- CD-G

Handling and Cleaning

- Dirt, dust, scratches and warping disc will cause non operation.
- Do not place stickers on disc or scratch disc.
- Do not warp discs.
- A disc should always be kept in its case when not in use to prevent damage.
- Do not place discs in the following places:
 1. Direct sunlight.
 2. Dirty, dusty and damp areas.
 3. Near car heaters.
 4. Car seats or dashboard.

Disc Cleaning

Use a dry soft cloth to wipe the surface. If the disc is quite dirty, use a soft cloth slightly moist with isopropyl (rubbing) alcohol. Never use solvents such as benzine, thinner or conventional record cleaners as they may mar the surface of the disc.

Note:

A disc may become somewhat scratched (although not enough to make it unusable) depending on handling and conditions in the usage environment.

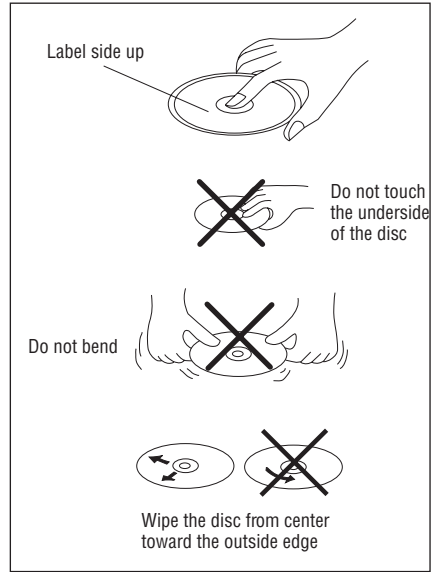

Preparing New Discs with Rough Spots

A new disc may have rough edges on its inside and outside edges. If a disc with rough edges is used, the proper setting will not be performed and the player will not play the disc. Therefore, remove the rough edges in advance by using a ball point pen or pencil as shown. To do this, press the side of the pen or pencil against the inside and outside edges of the disc.

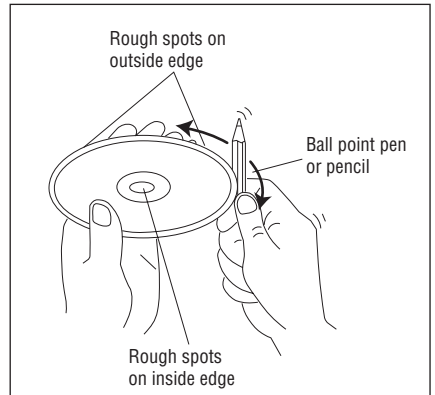

Radio Button Locations and Functions

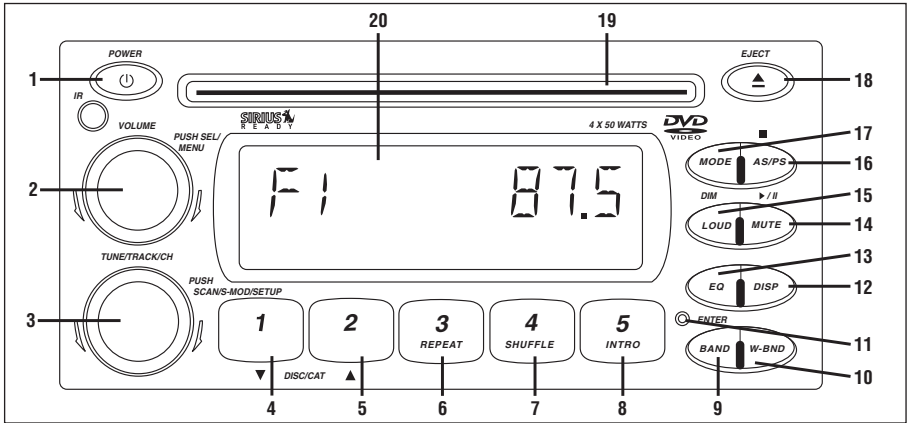

1. Power On/Off: Push to turn the unit on or off.

2. Volume/Sound Controls: Rotate to increase or decrease the volume level. Push to scan between the different sound controls (Volume, Bass, Treble, Balance and Fader).

3. Multi-Function Knob:

Radio Mode:

Manual Tuning: Rotate the TUNE knob to the left or right and hold until “MANUAL” appears in the display then release knob. Rotate the TUNE knob again left or right until the desired radio station appears in the display.

Scan Tuning: Push and release the TUNE knob. The tuner will scan up, pausing for 5 seconds at each strong station. Push and release the TUNE knob again to cancel the scan function.

Seek Tuning: Rotate the TUNE knob to the left or right and release. The tuner will scan to the next strong station and stop.

Sirius Satellite Radio Mode: Push to access Manual Tuning, Category Tuning and Direct Tuning in Sirius mode. (See Sirius Radio Operation for more information, page 15)

DVD Mode: Push to enter DVD Setup Mode (See DVD Setup for more information, page 20)

CD and CD Changer Mode: Rotate the TUNE knob to the left or right to change the CD track on the disc that is playing.

4. Multi-Function Button #1:

Radio Mode: Push and hold until a beep is heard to memorize a radio station into memory #1. Push and release when recalling preset radio station #1.

Sirius Satellite Radio Mode: Push and hold until a beep is heard to memorize a radio station into memory #1. Push and release when recalling preset radio station #1.

Push the TUNE button first until “CATEGORY” appears in the display then push button 1 to scroll down through the Sirius Radio playback categories.

CD Changer Mode: Push to change to a lower number disc in the CD changer.

5. Multi-Function Button #2:

Radio Mode: Push and hold until a beep is heard to memorize a radio station into memory #2. Push and release when recalling preset radio station #2.

Sirius Satellite Radio Mode: Push and hold until a beep is heard to memorize a radio station into memory #2. Push and release when recalling preset radio station #2.

Push the TUNE button first until “CATEGORY” appear in the display then push button 2 to scroll up through the Sirius Radio playback categories.

CD Changer Mode: Push to change to a higher number disc in the CD changer.

Radio Button Locations and Functions

6. Multi-Function Button #3:

Radio and Sirius Satellite Radio Modes: Push and hold until a beep is heard to memorize a radio station into memory #3. Push and release when recalling preset radio station #3.

DVD Mode: Push to select chapter repeat on, title repeat on or repeat off.

CD Mode: Push to repeat a CD track. Push again to cancel.

CD Changer Mode: Push to repeat a CD track. Push again to cancel.

Push and hold to repeat the entire disc. Push again to cancel.

7. Multi-Function Button #4:

Radio and Sirius Satellite Radio Modes: Push and hold until a beep is heard to memorize a radio station into memory #4. Push and release when recalling preset radio station #4.

CD Mode: Push to play all the tracks on the CD in random order. Push again to cancel.

CD Changer Mode: Push to play all the tracks on the CD in random order. Push again to cancel.

Push and hold to play all the CDs in random order. Push again to cancel.

8. Multi-Function Button #5:

Radio and Sirius Satellite Radio Modes: Push and hold until a beep is heard to memorize a radio station into memory #5. Push and release when recalling preset radio station #5.

CD Mode: Push to preview each track on the CD for 10 seconds. Push again to cancel.

CD Changer Mode: Push to preview each track on the CD for 10 seconds. Push again to cancel.

Push and hold to preview each track on every CD for 10 seconds. Push again to cancel.

9. Band Button:

Radio Mode: Push to select F1, F2, F3, AM1, AM2 or W (weather band).

Sirius Mode: Push to select SR1, SR2, SR3 or SR4.

10. Weather Band Radio Button: Push to instantly access the weather band radio. Push the MODE button to return to previous source.

11. Reset Button: Push to restore last programmed settings.

12. Display Button: Push to display the frequency in radio mode, title/chapter in DVD mode or track in CD mode. Push and hold to perform clock setting functions (See Clock Setting for more information, page 12).

13. Equalizer Button: Push to choose between preset sound equalization settings.

14. Mute Button (DVD, CD Play/Pause) Button:

Radio and Sirius Satellite Radio Mode: Push to mute volume level. Push again to restore volume.

DVD, CD and CD Changer Mode: Push to pause disc play, push again to resume play.

15. Loud (Dim Button): Push and release to boost high and low tones at low volume levels. Push and hold to dim or restore backlight of display.

16. AS/PS (DVD and CD Stop Button):

Radio Mode: Push for automatic memory storing and preset scan.

DVD and CD Mode: Push to stop the DVD or CD.

17. Mode Button: Push to change the play source: Radio, Sirius Satellite Radio, DVD/CD, CD Changer or Auxiliary Sources.

18. Eject Button: Push to eject a DVD/CD.

19. DVD/CD Slot: To play a disc insert a DVD or CD into slot with label facing up.

20. Display Area: This area displays all function information for the radios, clock and DVD/CD players.

Remote Control Button Locations and Functions

Inserting the Remote Control Battery:

1. Open the battery compartment.
2. Insert the CR2025 battery. Make sure that the positive (+) side of the battery is oriented correctly.
3. Close the battery compartment.

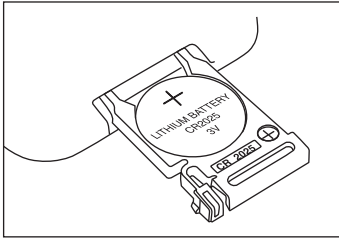

Using the Remote Control:

Point the remote control towards the remote infrared sensor (IR).

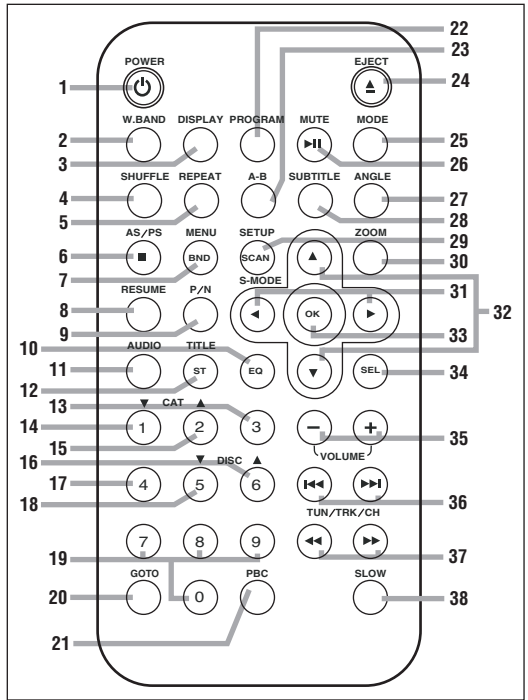
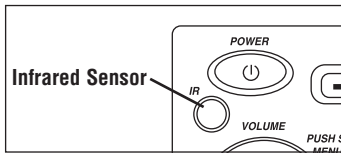

- 1. Power** Push to turn the unit on or off.
- 2. W.BAND** Push to instantly access the weather band radio. Push the MODE button to return to previous source.
- 3. DISPLAY** Push to display the frequency in radio mode, title/chapter in DVD mode or track in CD mode. Push and hold to perform clock setting functions (See Clock Setting for more information, page 12).
- 4. SHUFFLE** **CD Mode:** Push to play all the tracks on the CD in random order. Push again to cancel.
CD Changer Mode: Push to play all the tracks on the CD in random order. Push again to cancel.
- 5. REPEAT** **CD Mode:** Push to repeat a CD track. Push again to cancel.
CD Changer Mode: Push to repeat a CD track. Push again to cancel.
DVD Mode: Push to select Chapter Repeat On, Title Repeat On or Repeat Off.
- 6. ■ (AS/PS)** **Radio Mode:** Push and hold for automatic memory storing. Push and release to scan preset stations.
DVD Mode: Push to stop the DVD.
- 7. BND (MENU)** **Radio Mode:** Push to select F1, F2, F3, AM1, AM2 or W (weather band).
Sirius Satellite Radio Mode: Push to select SR1, SR2, SR3, and SR4.
DVD Mode: Push to access the root menu.
- 8. RESUME** **CD Mode:** When in stop mode, press this button and play will resume from the stop point.
- 9. P/N** **DVD Mode:** Switches between PAL, NTSC and AUTO modes.
- 10. EQ** Push to choose between preset sound equalization settings.

Remote Control Button Locations and Functions

- 11. AUDIO** **DVD Mode:** Changes the audio soundtrack on multi-audio soundtrack DVD disc.
- 12. ST (TITLE)** **Radio Mode:**
Mono/Stereo: You can sometimes improve reception of distant stations by selecting mono operation. Press and release to select mono or stereo mode in FM band only. Stereo mode is indicated by a ST in the display. Mono mode is indicated by a MON in the display.
Local/Distant: Local setting is for reception of strong stations, and distant setting is for reception of weaker stations. This function is in effect during Scan and Seek tuning. Press and hold to select local or distance mode in FM band only. Local mode is indicated by a LOC in the display. Distance mode is not indicated in the display.
DVD Mode: Push to display the Title menu that is stored in DVD disc (when available).
- 13. 3** **Radio Mode:** Push and hold until a beep is heard to memorize a radio station into memory #3. Push and release when recalling preset radio station #3.
Sirius Satellite Radio Mode: Push and hold until a beep is heard to memorize a radio station into memory #3. Push and release when recalling preset radio station #3.
DVD Mode: Push to select chapter repeat on, title repeat on or repeat off.
CD Mode: Use in conjunction with other numeric buttons to input track number.
CD Changer Mode: Push and release to repeat the track playing on the CD and “RPT” will appear in the display. Push again to cancel. Push and hold until “DRT” appears in the display to repeat the disc playing in the changer. Push again to cancel.
- 14. 1 (CAT ▼)** **Radio Mode:** Push and hold until a beep is heard to memorize a radio station into memory #1. Push and release when recalling preset radio station #1.
Sirius Satellite Radio Mode: Push and hold until a beep is heard to memorize a radio station into memory #1. Push and release when recalling preset radio station #1.
Push the SCAN button (29) first until “CATEGORY” appears in the display then push button 1 to scroll down through the Sirius Radio playback categories.
CD Mode: Use in conjunction with other numeric buttons to input track number.
- 15. 2 (CAT ▲)** **Radio Mode:** Push and hold until a beep is heard to memorize a radio station into memory #2. Push and release when recalling preset radio station #2.
Sirius Satellite Radio Mode: Push and hold until a beep is heard to memorize a radio station into memory #2. Push and release when recalling preset radio station #2.
Push the SCAN button (29) first until “CATEGORY” appear in the display then push button 2 to scroll up through the Sirius Radio playback categories.
CD Mode: Use in conjunction with other numeric buttons to input track number.
CD Changer Mode: Push and release to scan each track on the CD and “SCN” will appear in the display. Push again to cancel. Push and hold until “DSN” appears in the display to scan each track on each disc in the CD Changer. Push again to cancel.
- 16. 6 (DISC ▲)** **CD Mode:** Use in conjunction with other numbered buttons to input track number.
CD Changer Mode: Push to change to a higher disc in the CD changer.
- 17. 4** **Radio Mode:** Push and hold until a beep is heard to memorize a radio station into memory #4. Push and release when recalling preset radio station #4.
Sirius Satellite Radio Mode: Push and hold until a beep is heard to memorize a radio station into memory #4. Push and release when recalling preset radio station #4.
CD Mode: Use in conjunction with other numeric buttons to input track number.
CD Changer Mode: Push and release to play all the tracks on the CD in random order and “SHF” will appear in the display. Push again to cancel. Push and hold until “DSF” appears in the display to play all the discs in random order. Push again to cancel.

Remote Control Button Locations and Functions

- 18. 5 (DISC ▼)** **Radio Mode:** Push and hold until a beep is heard to memorize a radio station into memory #5. Push and release when recalling preset radio station #5.
Sirius Satellite Radio Mode: Push and hold until a beep is heard to memorize a radio station into memory #5. Push and release when recalling preset radio station #5.
CD Mode: Use in conjunction with other numeric buttons to input track number.
CD Changer Mode: Push to change to a lower disc in the CD changer.
- 19. 7, 8, 9, 0** Use in conjunction with other numeric buttons.
- 20. GO TO** **DVD Mode:** Goes to bookmark function during DVD playback.
- 21. PBC** Change between PBC On and PBC Off on VCD discs.
- 22. PROGRAM** **CD Mode:** Allows the tracks to be played in the order you programmed (See Programming CD Tracks into Memory, page 13).
- 23. A-B** **CD and DVD Modes:** Allows a passage to be repeated continuously (CD and DVD).
- 24. ▲ (EJECT)** Push to eject a DVD/CD.
- 25. MODE** Push to change the play source: Radio, Sirius Satellite Radio, DVD/CD, CD Changer or Auxiliary Sources.
- 26. ►|| (MUTE)** **Radio and Sirius Satellite Radio Mode:** Push to mute volume level. Push again to restore volume.
CD and CD Changer Mode: Push to pause disc play, push again to resume play.
DVD Mode: Push to pause movie play, push again to resume play.
- 27. ANGLE** **DVD Mode:** Changes the view angle on multi-angle DVD disc.
- 28. SUBTITLE** **DVD Mode:** Changes the Subtitle language on multi-subtitle language DVD disc.
- 29. SCAN (SETUP)** **Radio Mode: Scan Tuning:** Push and release the SCAN button. The tuner will scan up, pausing for 5 seconds at each strong station. Push and release the SCAN button again to cancel the scan function.
DVD Mode: Push to enter DVD Setup Mode (See DVD Setup for more information, page 20)
Sirius Satellite Radio Mode: Push to access Manual Tuning, Category Tuning and Direct Tuning. (See Sirius Radio Operation for more information, page 15).
- 30. ZOOM** **DVD Mode:** Enlarges or reduces size of picture.
- 31. ◀/▶** **Radio Mode: Manual Tuning:** Push and hold one of the buttons until "MANUAL" appears in the display then release button. Push the buttons again up or down until the desired radio station appears in the display.
DVD Mode: When the menu is displayed these buttons work as navigational buttons. When a movie is playing these buttons work as Chapter Skip buttons.
- 32. ▲/▼** **Radio Mode: Seek Tuning:** Push the left or right button and release. The tuner will scan to the next strong station and stop.
DVD Mode: When the menu is displayed these buttons work as navigational buttons. When a movie is playing these buttons work as Fast Forward (FF) and Fast Rewind (FR) buttons.

Remote Control Button Locations and Functions

- 33. OK** **DVD Mode:** Confirm the Track/Chapter selected with the numeric buttons or selected with the cursor buttons on screen display.
- 34. SEL** Push to scan between the different sound controls (Volume, Bass, Treble, Balance and Fader). Then push VOL +/- to change the setting.
- 35. - / +**
VOLUME Push to increase or decrease the volume level.
- 36. |◀◀ / ▶▶|**
TUN/TRK/CH **Radio Mode:** Push the left or right button and release. The tuner will scan to the next strong station and stop.
Sirius Satellite Radio Mode: Push the left or right button and release. The tuner will go to the next station and stop.
CD and CD Changer Mode: Push the left or right button and release to change the track on the CD that is playing.
DVD Mode: When a movie is playing these buttons work as Chapter Skip buttons.
- 37. ◀◀ / ▶▶** **Radio:** Push the left or right button until the desired radio station appears in display.
CD and CD Changer Mode: Push and hold the left or right button to Fast Rewind or Fast Forward the track playing.
DVD Mode: When a movie is playing push ▶▶ to scroll through Fast Forward (FF 2 X, FF 4 X, FF 6 X, FF 8 X and PLAY to return to normal). Push ◀◀ to scroll through Fast Reverse (FR 2 X, FR 4 X, FR 6 X, FR 8 X and PLAY to return to normal).
- 38. SLOW** **DVD Mode:** Push to scroll through Slow Forward (SF 2 X, SF 4 X, SF 8 X) then Slow Reverse (SR 2 X, SR 4 X, SR 8 X) then normal (PLAY).

Basic Operation

Turning the Unit On and Off: Push the **Power** button.

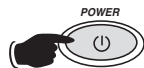

Selecting Play Source: Push the **Mode** button to choose a play source: Radio, Sirius Satellite Radio (if equipped), CD/DVD, External CD Changer (if equipped) or Auxiliary Sources (if equipped).



Dimming the Display: Push and hold the **LOUD** button to dim the backlight of the display. Push and hold again to return to normal illumination.

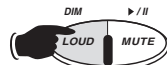

AM/FM Radio Operation

AM/FM Bands: Push **BAND** button to select a radio band: F1, F2, F3, AM1, AM2 or W (weather band).



Manual Tuning:

1. Rotate the **TUNE** knob left or right and hold until "MANUAL" appears in the display, then release knob.
2. Rotate the **TUNE** knob again left or right until the desired radio station appears in the display.

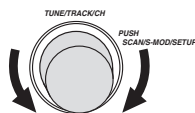

Scan Tuning: Push the **TUNE** knob to have the radio automatically scan every 5 seconds for a different radio station. To stop scanning push the **TUNE** knob again.

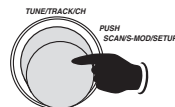

Seek Tuning: Rotate the **TUNE** knob left or right, then release to seek for a different radio station.

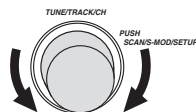

Preset AM/FM Radio Stations

Programming AM/FM Radio Stations: You can program up to 15 FM radio stations and 10 AM radio stations.

1. Select from F1, F2, F3, AM1 or AM2 by pushing the **BAND** button repeatedly.
2. Tune to the desired radio station (see AM/FM Radio Operation above for more details).
3. Push and hold one of the five **STATION RECALL** buttons until a short "beep" is heard. The corresponding preset button number now appears in the lower right hand corner of the display.
4. To program additional preset stations, repeat this procedure using the other **STATION RECALL** buttons.



Automatically Programming AM/FM Radio Stations: You can program up to 15 FM radio stations and 10 AM radio stations automatically.

1. Select from F1, F2, F3, AM1 or AM2 by pushing the **BAND** button repeatedly.
2. Push and hold **AS/PS** button until the display starts scanning for a radio station. The radio will automatically program the 5 strongest station into preset memory.



Preset AM/FM Radio Stations (continued)

Recalling AM/FM Radio Stations:

1. Select from F1, F2, F3, AM1 or AM2 by pushing the **BAND** button repeatedly.
2. Push button 1, 2, 3, 4 or 5 to recall a preprogrammed radio station.



Automatically Recalling AM/FM Radio Stations:

1. Select from F1, F2, F3, AM1 or AM2 by pushing the **BAND** button repeatedly.
2. Push the **AS/PS** button and release to automatically scan every 5 seconds the through preprogrammed radio stations. To stop scanning push the **AS/PS** button again.



Weather Band Radio Operation

Weather Band: Push the **W-BND** button to immediately access the weather band. The radio will search for the strongest weather band signal in your area.



Scan Tuning: Push the **TUNE** knob to scan every 5 seconds through all 7 weather band stations. To stop scanning push the **TUNE** knob again.

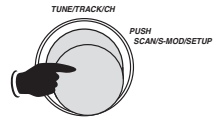

Manual Tuning:

1. Rotate the **TUNE** knob left or right and hold until "MANUAL" appears in the display, then release knob.
2. Rotate the **TUNE** knob again left or right until the desired weather band radio station appears in the display.

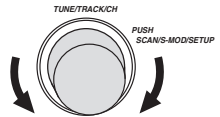

Directly Recalling Weather Band Radio Stations:

1. Push button 1, 2, 3, 4 or 5 to directly recall weather band station 1 thru 5.



Sound Controls

Volume Control: Rotate the **VOLUME** knob to the right to increase levels or left to decrease levels.

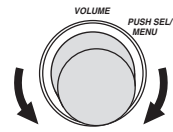

Bass, Treble, Balance and Fader Controls: Push and release the **VOLUME** knob to scan between the different sound controls. Once the desired function is in the display area rotate the knob left or right to achieve the desired level.

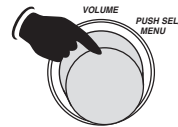

Bass Control: The bass control adjusts the amount of low frequency that you hear.

Treble Control: The treble control adjusts the amount of high frequency that you hear.

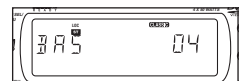

Balance Control: The balance control adjusts the amount of sound output to the left and right speakers.

Fader Control: The fader control adjusts the amount of sound output to the front and rear speakers.

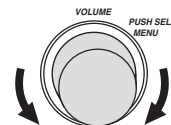

Sound Controls (continued)

Equalizer: Push the **EQ** button to choose between preset equalizer settings: Classic, Rock, DSP Off (digital sound processor off), Flat, Pop and Jazz, as indicated in the display area.



Mute (DVD, CD Play/Pause) Button: Push the **MUTE** button to mute the radio volume. If a DVD or CD is playing the **MUTE** button will pause the disc. Push the **MUTE** button again to restore the volume or resume playing the disc.

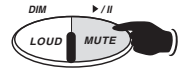

Loudness: Push the **LOUD** button to boost high and low tones at low volume levels.



Clock Setting

Display Button: Push and hold the **DISP** button until the clock is flashing in the display.



Adjusting the Minutes: Rotate the **TUNE** knob to the Left to adjust the Minutes.

Adjusting the Hours: Rotate the **TUNE** knob to the Right to adjust the Hours.
Note: the AM/PM indicators.

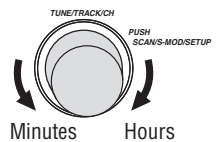

When correct time displays wait a few seconds to allow the time to program.

CD Operation

Playing a CD: Insert a CD (label side up) into the CD slot. The CD will auto-load and start playing.

Note: If a CD does not auto-load **DO NOT FORCE IT** into the slot, as you may already have a disc loaded.

CD Track Selection: Rotate the **TUNE** knob left or right to change the track. The track number will appear in the display.

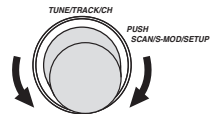

Pausing a CD: Push the **MUTE** button to "Pause" the disc, push again to resume play.



Ejecting a CD: Push the **EJECT** button to eject a disc.



Repeating a CD Track: Select the desired track to repeat then push the **REPEAT** button until "S-RPT" appears in the display. That track will play repeatedly. To cancel this feature push the **REPEAT** button until "S-RPT" disappears from the display.



Random CD Track Play Order: Push the **SHUFFLE** button until "S-SHF" appears in the display. The tracks on the disc will play in a random order. To cancel this feature push the **SHUFFLE** button until "S-SHF" disappears from the display.



Preview CD Tracks: Push the **INTRO** button until "S-SCN" appears in the display. Each track on the disc will play for 10 seconds. To cancel this feature push the **INTRO** button until "S-SCN" disappears from the display.



CD Operation (continued)

Elapse Times: Push the **AS/PS** button to display running time of CD track, push the button again to display the time remaining on the CD track, push one more time to display time remaining on CD.

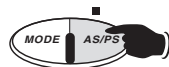

Programming CD Tracks into Memory (Using the Remote Control):

1. In CD mode, push the ■ **AS/PS** button on the remote control.
2. Push the **PROGRAM** button and P00-0000 will appear in the display.
3. Push the **Numeric** buttons to select the first track to be programmed into memory. For example: push numeric button 4, "P01-004" appears in the display indicating that track 4 will be played first.
4. Repeat Step 3 to store up to 99 tracks into memory.
5. Push the ►|| **MUTE** button to play tracks in programmed order.

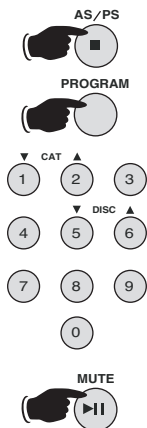

Canceling Programmed CD Tracks:

1. Push the ■ **AS/PS** button.
2. Push the **PROGRAM** button.
3. Push the ►|| **MUTE** button to resume normal play.



CD Changer Operation

Loading CDs: Load CDs into the CD magazine and insert the magazine into the external CD changer.

Selecting the External CD Changer: Push the **MODE** button until “CDC” appears in the display.

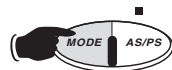

CD Selection: Push button **1** or **2** to scroll through the selection of CDs in the CD changer. If a CD is not in one of the trays, the unit will continue until the next CD is found.

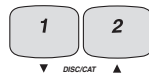

CD Track Selection: Rotate the **TUNE** knob left or right to change the track. The track number will appear in the display.

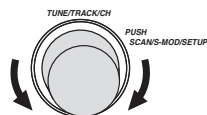

Repeating a CD Track: Select the desired track to repeat then push and release the **REPEAT** button until “RPT” appears in the display. The track on the disc will play repeatedly. To cancel this feature push the **REPEAT** button until “RPT” disappears in the display.



Repeating a CD: Select the desired CD to repeat then push and hold the **REPEAT** button until “DPT” appears in the display. The entire disc will play repeatedly. To cancel this feature push the **REPEAT** button until “DPT” disappears from the display.

Random CD Track Play Order: Push and release the **SHUFFLE** button until “SHF” appears in the display. The tracks on the disc will play in a random order. To cancel this feature push the **SHUFFLE** button until “SHF” disappears from the display.



Random CD Play Order: Push and hold the **SHUFFLE** button until “DSF” appears in the display. The discs will play in a random order. To cancel this feature push the **SHUFFLE** button until “DSF” disappears from the display.

Preview CD Tracks: Push and release the **INTRO** button until “SCN” appears in the display. Each track on the disc will play for 10 seconds. To cancel this feature push the **INTRO** button until “SCN” disappears from the display.



Preview CDs: Push and hold the **INTRO** button until “DSN” appears in the display. Each track on every disc will play for 10 seconds. To cancel this feature push the **INTRO** button until “DSN” disappears from the display.

Sirius Satellite Radio Setup

Note: If your Sirius tuner is not activated, call 1-888-539-SIRIUS to activate. The Sirius Tuner ID Number (ESN) is required during the activation process. Following the instructions below to access the Sirius Tuner ID Number (ESN):

Accessing your Sirius Tuner ID Number (ESN):

1. Push the **MODE** button until “SIRIUS” appears in the display area.
2. Push the **TUNE** button until “DIRECT” appears in the display area. Wait a few seconds and “CH 000” will then appear in the display.
3. Push the **BAND** button and the first 4 digits of the 12 digit Sirius Tuner ID Number (ESN) will be displayed.
4. Push the **DISP** button and the last 8 digits of your 12 digit Sirius Tuner ID Number (ESN) will be displayed.
5. Push the **TUNE** button to exit.



TUNE/TRACK/CH



PUSH
SCAN/S-MOD/SETUP



TUNE/TRACK/CH

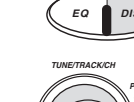

PUSH
SCAN/S-MOD/SETUP



TUNE/TRACK/CH



PUSH
SCAN/S-MOD/SETUP

Sirius Satellite Radio Operation

Please note that satellite radio signal may be blocked by trees, buildings, bridges or tunnels.

Selecting Sirius Satellite Radio: Push the **MODE** button until “SIRIUS” appears in the display. Please be patient as it may take a minute to receive a satellite signal.



Manual Tuning:

1. Push the **TUNE** knob until “NORMAL” appears in the display.
2. Rotate the **TUNE** knob to select a station from 01-182.

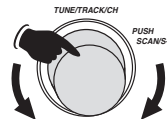

TUNE/TRACK/CH

PUSH
SCAN/S-MOD/SETUP

Category Tuning:

1. Push the **TUNE** knob until “CATEGORY” appears in the display.

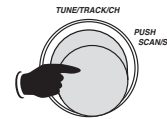

TUNE/TRACK/CH

PUSH
SCAN/S-MOD/SETUP

2. Push button **1** or **2** to find the desired category.

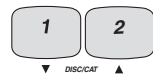

3. Rotate the **TUNE** knob and select a station within the category.

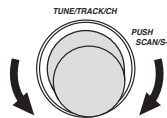

TUNE/TRACK/CH

PUSH
SCAN/S-MOD/SETUP

Sirius Satellite Radio Operation (Continued)

Direct Tuning:

1. Push the **TUNE** knob until "DIRECT" appears in the display.
2. Rotate the **TUNE** knob and select the first digit (0 or 1).
3. Push the **TUNE** knob again.
4. Rotate the **TUNE** knob and select the second digit (1-8).
5. Push the **TUNE** knob again.
6. Rotate the **TUNE** knob and select the third digit (1-9). The tuner will start playing the station you have selected when the third digit stops flashing.

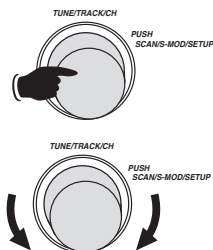

Preset Sirius Satellite Radio Stations

Programming Satellite Radio Stations: You can program up to 20 Sirius Satellite radio stations.

1. Select from SR1, SR2, SR3 or SR4 by pushing the **BAND** button repeatedly.
2. Tune to the desired radio station (see Sirius Satellite Radio Operation for more details).
3. Push and hold one of the five **STATION RECALL** buttons until a short "beep" is heard. The corresponding preset button number now appears in the lower right hand corner of the display.
4. To program additional preset stations, repeat this procedure using the other **STATION RECALL** buttons as desired.



Recalling Satellite Radio Stations:

1. Select from SR1, SR2, SR3 or SR4 by pushing the **BAND** button repeatedly.
2. Push button 1, 2, 3, 4 or 5 to recall a preprogrammed radio station.



Automatically Recalling Satellite Radio Stations:

1. Select from SR1, SR2, SR3 or SR4 by pushing the **BAND** button repeatedly.
2. Push **AS/PS** button and release to automatically scan every 5 seconds the pre-programmed radio stations. To stop scanning push the **AS/PS** button again.



Channel Skip Sirius Satellite Radio

Programming Channel Skip for Satellite Radio Stations: You can program the radio to skip channels which you do not want.

1. Tune to the station to be skipped (see Sirius Satellite Radio Operation for more details).
2. Push the **TUNE** knob until “SET SKIP” appears in the display.
3. Push the **BAND** button and “SKIP” will appear flashing in the bottom of the display. When the “SKIP” stops flashing the channel has been programmed to skip.

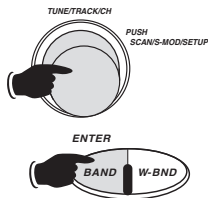

Release Channel Skip for Satellite Radio Stations:

1. Push the **TUNE** knob until “DIRECT” appears in the display.
2. Rotate the **TUNE** knob and select the first digit of the skipped channel (0 or 1).
3. Push the **TUNE** knob again.
4. Rotate the **TUNE** knob and select the second digit of the skipped channel (1-8).
5. Push the **TUNE** knob again.
6. Rotate the **TUNE** knob and select the third digit of the skipped channel (1-9). The tuner will start playing the station you have selected when the third digit stops flashing.
7. Push the **TUNE** knob until “SET SKIP” appears in the display. After a few seconds the radio channel will appear in the display with “SKIP” flashing at the bottom.
8. Push the **BAND** button and “SKIP” will stop flashing in the bottom of the display. When the “SKIP” disappears the channel has been released from Channel Skip.

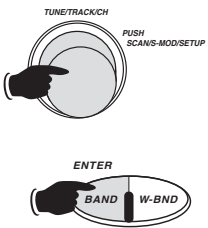
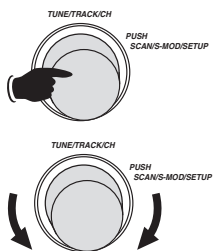

Auxiliary Input

Selecting Auxiliary Input: Push the **MODE** button until “AV IN1” or “AV IN2” appears in the display which indicates that the auxiliary unit is playing through the M9900DVDS.



Note: All sound controls (pages 11-12) are active when the Auxiliary source is playing.

DVD Operation

Playing a DVD: Insert a DVD (label side up) into the DVD slot.

Note: If a DVD does not auto-load **DO NOT FORCE** into the slot, as you may already have a CD or DVD loaded.

1. The DVD will start playback automatically and stop at the menu display.
2. Use the **Navigation** ◀/▶, ▲/▼ buttons on the remote to move the highlighted bar in the menu.
3. Press **OK** button on the remote to confirm selection.

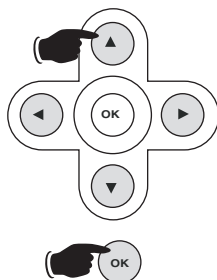

Stopping a DVD: Push the ■ **AS/PS** button to stop the unit playback, when the ►► **MUTE** button is pressed, normal playback will continue.

Push the ■ **AS/PS** button twice to stop the playback and go back to initial Chapter.



Pausing a DVD: Push the ►► **MUTE** button to "Pause" the disc, push it again to resume play.



Ejecting a DVD: Push the **EJECT** button to eject a disc.



Chapter Skip: Push the ►► button to skip forward to the next chapter. Push the ◀◀ button to skip backwards to the previous chapter.



Fast Reverse/Fast Forward: Push the ◀◀ or ►► buttons to fast reverse or fast forward during play. Each time the button is pressed the speed changes.

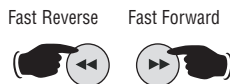
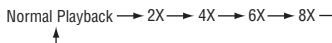

Slow Motion Forward/Reverse: Push the **SLOW** button to scroll through Slow Forward (SF 2X, SF 4X, SF 8x) then Slow Reverse (SR 2X, SR 4X, SR 8x) then normal (PLAY).

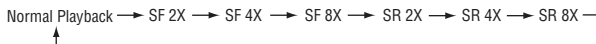

Repeat Play: Push the **REPEAT** button to scroll through Chapter Repeat On, Title Repeat On and Repeat Off.

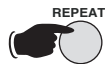

Passage Repeat: Allows a passage to be repeated continuously.

1. Push the **A-B** button at the start of the required passage.
2. Push the **A-B** button at the end of the passage. The unit will repeat playing the passage set from A to B.



Canceling Passage Repeat. To revert to normal play push the **A-B** button again.

DVD Operation (continued)

GO TO Title/Chapter Select Function: To directly select a Title/Chapter follow these directions:

1. Push the **GO TO** button and the screen will display the TITLE and CHAPTER information.

2. Use the **Numeric** buttons to input the Title/Chapter number.

3. Push the **OK** button to execute the GO TO function.

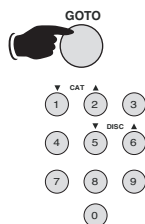

GO TO Time Select Function: To directly select a time in the DVD follow these directions:

1. Push the **GO TO** button TWICE and the screen will display the TITLE and TIME information.

2. Use the **Numeric** buttons to input the Time.

3. Push the **OK** button to execute the GO TO function.

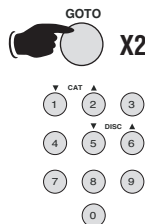

DVD Disc Information: Push the **DISPLAY** button to scroll through playback to display the console information of the current disc onscreen.

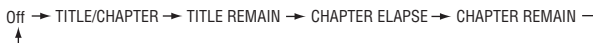

PAL/NTSC System Selection: Press the **P/N** button to switch between PAL, NTSC and AUTO modes.

Note: This function is only effective when the DVD logo is displayed or when disc play is stopped.



Audio Languages Function: Push the **AUDIO** button during playback. Each time the button is pressed, the audio soundtrack language changes in sequential order.

Notes:

- The language number maybe different according to the disc.
- Some discs only contain one language soundtrack.
- When no different language soundtracks are recorded,  will be displayed in the top left corner of the screen.



Subtitle Languages Function: Push the **SUBTITLE** button during playback. Each time the button is pressed, the subtitle language changes in sequential order.

Notes:

- The language number maybe different according to the disc.
- Some discs only contain one subtitle language.
- When no different language soundtracks are recorded,  will be displayed in the top left corner of the screen.



DVD Operation

Angle Function: Push the **ANGLE** button during playback. Each time the button is pressed, the angle changes in sequential order.

Notes:

- The angle number maybe different according to the disc.
- The function only works for discs having scenes recorded at different angles.
- When no different angles are recorded,  will be displayed in the top left corner of the screen.



Zoom Function: Allows the picture to be increased in size. Push the **ZOOM** button during playback. Each time the button is pressed, the zoom changes in sequential order.

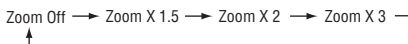





Note: During ZOOM mode, press the , , ,  buttons to move picture left, right, up or down.

DVD Setup

Initial Setup

| |
|-------------------------|
| SETUP MENU -- MAIN PAGE |
| GENERAL SETUP |
| AUDIO SETUP |
| PREFERENCES |
| EXIT SETUP |

1. Press **SCAN/SETUP** and the Initial Setup Menu is displayed.
2. Select the preferred item by using the , , ,  buttons.
3. Push **OK** button to enter selected menu.



General Setup

| | |
|--------------------|------------|
| -- GENERAL PAGE -- | |
| TV DISPLAY | NORMAL /PS |
| PIC MODE | NORMAL /LB |
| ANGLE MARK | WIDE |
| OSD LANG | |
| CAPTIONS | |
| SCREEN SAVER | |
| MAIN PAGE | |

TV DISPLAY Setup: This is to select the appropriate TV aspect ratio (4:3 or 16:9) according to the connected TV set.

NORMAL /PS (For 4:3 TV): Played back in PAN and SCAN style (If connected to wide-screen TV, the left and right edges are cut off).

NORMAL /LB (For 4:3 TV) Played back in letter box style (If connected to wide-screen TV, black bands appear at top and bottom of the screen).

WIDE (For 16:9 TV): Select when a wide-screen TV set is connected.

Menus

General Setup: This setup page includes all the items of TV display and Audio output features. (See General Setup Menu for more information)

Audio Setup: This setup page includes all the items for Audio. (See Audio Setup Menu for more information)

Preferences Setup: This setup page includes all the support features. (See Preferences Setup Menu for more information)

DVD Setup

| -- GENERAL PAGE -- | |
|--------------------|-------------|
| TV DISPLAY | |
| PIC MODE | AUTO |
| ANGLE MARK | HI-RES |
| OSD LANG | NON-FLICKER |
| CAPTIONS | |
| SCREEN SAVER | |
| MAIN PAGE | |

PIC Setup: Select AUTO, the player PIC mode will depend on DVD disc. Select HI-RES format for best image resolution. Select NON-FLICKER format on image or picture with noise or distortion.

| -- GENERAL PAGE -- | |
|--------------------|-----|
| TV DISPLAY | |
| PIC MODE | |
| ANGLE MARK | ON |
| OSD LANG | OFF |
| CAPTIONS | |
| SCREEN SAVER | |
| MAIN PAGE | |

ANGLE MARK Display Setup: If it is set ON, when a multi-angle DVD disc is playing, “” (the angle mark) will appear on the screen. If it is set to “OFF” the mark will not appear.

| -- GENERAL PAGE -- | |
|--------------------|---------|
| TV DISPLAY | |
| PIC MODE | |
| ANGLE MARK | |
| OSD LANG | ENGLISH |
| CAPTIONS | FRENCH |
| SCREEN SAVER | GERMAN |
| MAIN PAGE | SPANISH |

OSD LANG (On-Screen Language Display) Setup: Select the preferred On-Screen Display language by using the ▲/▼ buttons.

| -- GENERAL PAGE -- | |
|--------------------|-----|
| TV DISPLAY | |
| PIC MODE | |
| ANGLE MARK | |
| OSD LANG | |
| CAPTIONS | ON |
| SCREEN SAVER | OFF |
| MAIN PAGE | |

Captions Setup: When playing DVD disc, activate the CAPTIONS feature by selecting ON and the captions (such as the actor dialogue) appear on the screen. Deactivate this feature by selecting OFF and the caption will appear.

| -- GENERAL PAGE -- | |
|--------------------|-----|
| TV DISPLAY | |
| PIC MODE | |
| ANGLE MARK | |
| OSD LANG | |
| CAPTIONS | |
| SCREEN SAVER | ON |
| MAIN PAGE | OFF |

SCREENSAVER Setup: Select the SCREENSAVER ON or OFF.

Audio Setup

| -- AUDIO PAGE -- | |
|------------------|----------|
| LPCM OUTPUT | LPCM 48K |
| | LPCM 96K |
| MAIN PAGE | |

LPCM Setup: Select the LPCM (Line Pulse Code Modulation) OUTPUT between LPCM 48K and LPCM 96K. The higher the sampling frequency is, the better the output audio quality will be. It is recommended to select LPCM 96K compression.

Preferences Setup

| -- PREFERENCES -- | |
|-------------------|------|
| TV TYPE | AUTO |
| AUDIO | NTSC |
| SUBTITLE | PAL |
| DISC MENU | |
| PARENTAL | |
| PASSWORD | |
| DEFAULTS | |
| MAIN PAGE | |

TV TYPE Setup: This play can play discs recorded in either PAL or NTSC format. Select NTSC format, when the unit is connected to a NTSC TV. Select PAL format, when the unit is connected to a PAL TV. Select AUTO format, the player TV output format will be according to the DVD disc format.

DVD Setup

Preferences Setup

| -- PREFERENCES -- | |
|-------------------|----------|
| TV TYPE | |
| AUDIO | ENGLISH |
| SUBTITLE | FRENCH |
| DISC MENU | SPANISH |
| PARENTAL | CHINESE |
| PASSWORD | JAPANESE |
| DEFAULTS | GERMAN |
| MAIN PAGE | |

AUDIO Setup: Select the preferred AUDIO language by using the cursor buttons.

| -- PREFERENCES -- | |
|-------------------|----------|
| TV TYPE | |
| AUDIO | ENGLISH |
| SUBTITLE | FRENCH |
| DISC MENU | SPANISH |
| PARENTAL | CHINESE |
| PASSWORD | JAPANESE |
| DEFAULTS | GERMAN |
| MAIN PAGE | OFF |

SUBTITLE Setup: Select the preferred SUBTITLE language by using the cursor buttons.

| -- PREFERENCES -- | |
|-------------------|----------|
| TV TYPE | |
| AUDIO | |
| SUBTITLE | ENGLISH |
| DISC MENU | FRENCH |
| PARENTAL | SPANISH |
| PASSWORD | CHINESE |
| DEFAULTS | JAPANESE |
| MAIN PAGE | GERMAN |

DISC MENU Setup: Select the preferred DISC MENU language by using the cursor buttons.

| -- PREFERENCES -- | |
|-------------------|---------|
| TV TYPE | 1 G |
| AUDIO | 2 |
| SUBTITLE | 3 PG |
| DISC MENU | 4 PG13 |
| PARENTAL | 5 |
| PASSWORD | 6 PG-R |
| DEFAULTS | 7 NC-17 |
| MAIN PAGE | 8 ADULT |

PARENTAL Setup: Select a suitable parental guidance by the cursor buttons and confirm by pressing the OK button.

| -- PREFERENCES -- | |
|-------------------|--------|
| TV TYPE | |
| AUDIO | |
| SUBTITLE | |
| DISC MENU | |
| PARENTAL | |
| PASSWORD | CHANGE |
| DEFAULTS | |
| MAIN PAGE | |

PASSWORD Setup: Select CHANGE and press the OK button. Type the old password (The initial factory code is 3308) then key-in a new 4-character password. Then retype it again to confirm new password.

| -- PREFERENCES -- | |
|-------------------|-------|
| TV TYPE | |
| AUDIO | |
| SUBTITLE | |
| DISC MENU | |
| PARENTAL | |
| PASSWORD | |
| DEFAULTS | RESET |
| MAIN PAGE | |

DEFAULTS: Select reset to revert to factory initial settings.

DEFAULT SETTINGS

| GENERAL SETUP | TV DISPLAY | NORMAL/PS |
|---------------|--------------|-----------|
| | PIC MODE | AUTO |
| | ANGLE MARK | ON |
| | OSD LANGUAGE | ENGLISH |
| | CAPTIONS | OFF |
| | SCREENSAVER | OFF |
| AUDIO SETUP | LPCM OUTPUT | LPCM 96K |
| PREFERENCES | TV TYPE | AUTO |
| | AUDIO | ENGLISH |
| | SUBTITLE | ENGLISH |
| | DISC MENU | ENGLISH |
| | PARENTAL | 6PG-R |
| | PASSWORD | 3308 |
| | DEFAULT | RESET |

Speciality Features

Display Button: The factory default setting is clock display priority. Push the **DISPLAY** button at any time to display the radio frequency, CD track, AUX 1 or AUX 2.

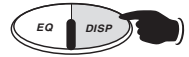

Note: In the Sirius mode the factory default setting is Sirius channel display priority. Push the **DISPLAY** button at any time to display the CN-NAME, SONG TITLE, ARTIST, CATEGORY and Clock. If clock is chosen the time will be displayed for approximately 5 seconds then revert to displaying the Category.

Restoring Factory Default Setting: To restore the radio to the factory default setting:

1. Press the **MODE** button to select the radio band.
2. Push the **BAND** button and hold until "EEP INIT" appears in the display. All settings will be restored to the factory default.

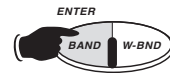

Reset Button: The radio panel or LCD display may fail to function normally due to the vehicle's battery condition, and may require resetting the radio microprocessor if:

- The vehicle has been "jump started" from a dead battery condition.
- The vehicle battery becomes very low and is quick-charged.
- The vehicle battery is removed and replaced.

Should this condition occur, simply press and release the **RESET** button on the radio panel using the tip of a ball point pen. This will reset the radio microprocessor to the original factory settings. After pressing the **RESET** button you should recheck to see if the radio functions normally. All station programming should remain, but you will have to reset the clock. Should the LCD display area show any abnormal error code, please refer to the trouble shooting guide and solution chart below.

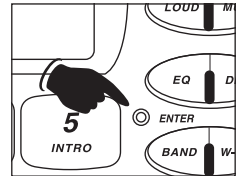

| Error Code | Problem | Description | Possible Remedy |
|------------|-------------------------------|---|--|
| ERR 1 | Mechanism Problem | Unknown mechanical problem with the CD mechanism. | <ol style="list-style-type: none"> 1. Eject the disc and try another. 2. Press the reset button. 3. Replace the unit. |
| ERR 2 | TOC Reading Error | Laser can not read the CD disc table of contents. | <ol style="list-style-type: none"> 1. Insert a different disc. 2. Check disc for excessive scratches. 3. Check disc for dirt and fingerprints. Clean disc and reinsert. |
| ERR 3 | Error from High Ambient Temp. | The temperature of the mechanism is too high to play CDs without damaging them. | Reduce the temperature inside the vehicle and try to play a CD at a later time. |
| ERR 4 | DVD Error | Error during playback of disc. | <ol style="list-style-type: none"> 1. Insert a different disc. 2. Check disc for excessive scratches. 3. Check disc for dirt and fingerprints. Clean disc and reinsert. 4. Press the reset button. |
| ERR 5 | Disc Error | Error during eject and loading disc. | <ol style="list-style-type: none"> 1. Push the reset button. 2. Replace the unit. |

Changing the Default Settings

The M9900DVDS has a small group of settings that can be changed to suit your personalized requirement.

Button Confirmation Beep: The factory default setting is BEEP ON (a confirmation beep every time a button or knob is pushed). To turn the beeps off, push and hold the **VOLUME** knob until “BEEP ON” is in the display then release. Rotate the **VOLUME** knob until “BEEP OFF” is in the display. Wait a few seconds, the radio will return to last radio mode selected.

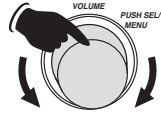

Power Up Volume Level: The factory default setting for initial power-up volume level is 12. To change the initial volume level, push and hold the **VOLUME** knob until “BEEP ON” is in the display then release. Push the **VOLUME** knob until “P-VOL” is in the display. Rotate the **VOLUME** knob until the desired initial volume is achieved. Wait a few seconds, the radio will return to last radio mode selected.

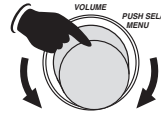

Radio Frequency Display: The factory default setting is USA. Do not change this setting.

Clock Display When the Radio is Off: When the ignition key is on and the radio is off, “clock display on” is the default setting. To change the setting to “clock display off”, push and hold the **VOLUME** knob until “BEEP ON” is in the display then release. Push the **VOLUME** knob until “CLK ON” is in the display. Rotate the **VOLUME** knob until “CLK OFF” is in the display. Wait a few seconds, the radio will return to last radio mode selected.

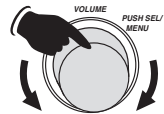

Display Priority: The factory default setting for display priority is “CLOCK” except in Sirius mode. To change the display priority (either radio frequency priority or no priority), push and hold the **VOLUME** knob until “BEEP ON” is in the display then release. Push the **VOLUME** knob until “CLOCK” is in the display. Rotate the **VOLUME** knob until “FREQ” or “NO PRI” is in the display. Wait a few seconds, the radio will return to last radio mode selected.

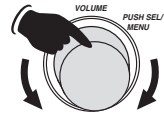

Clock Type, 12 hour or 24 hour: The factory default setting is 12 hour clock with AM and PM indication. To change the clock type to 24 hour military time, push and hold the **VOLUME** knob until “BEEP ON” is in the display then release. Push the **VOLUME** knob until “12 HOUR” is in the display. Rotate the **VOLUME** knob until “24 HOUR” is in the display. Wait a few seconds, the radio will return to last radio mode selected.

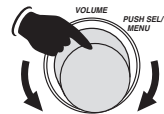

Installation

Step 1: The radio chassis is designed to be "Sleeve Mounted" through a opening in the dashboard panel. The required opening size is 182mm (7-3/16") x 84mm (3-5/16"). Cut or engage an opening in the dashboard to accommodate the mounting sleeve.

Step 2: Insert the mounting sleeve into the hole in the dashboard. Bend the metal tabs on the sleeve to secure the mounting sleeve to the dashboard.

Step 3: Bring all wiring for the connection of the unit (including the antenna) through the center of the mounting sleeve. Connect the wiring as follows:

Yellow Wire (w/Fuse): Connect this wire to a constant +12 volt power source (a power source that is not controlled by the ignition key).

Red Wire: Connect this wire to a switched +12 volt power source (a power source turned on and off by the ignition key).

Blue Wire: Connect this wire to the (+) power antenna activation circuit. If no power antenna exists, tape-off the end of this wire to prevent shorting out the unit.

Black Wire: Connect this wire to the frame of the vehicle (ground). This wire is the chassis grounding wire for the unit.

White Wire: Connect this wire to the Left Front Speaker (+) positive terminal or wire.

White Wire with Black Stripe: Connect this wire to the Left Front Speaker (-) negative terminal or wire.

Green Wire with Black Stripe: Connect this wire to the Left Rear Speaker (-) negative terminal or wire.

Green Wire: Connect this wire to the Left Rear Speaker (+) positive terminal or wire.

Gray Wire: Connect this wire to the Right Front Speaker (+) positive terminal or wire.

Gray Wire with Black Stripe: Connect this wire to the Right Front Speaker (-) negative terminal or wire.

Purple Wire with Black Stripe: Connect this wire to the Right Rear Speaker (-) negative terminal or wire.

Purple Wire: Connect this wire to the Right Rear Speaker (+) positive terminal or wire.

Note: This unit is designed to connect to (4) four speakers. If the installation only requires (2) two speakers, use the White and Gray wire sets to connect the speakers.

WARNING! Any wires left unconnected must be taped-off or capped off to prevent shorting.

DO NOT connect speaker ground wires together.

DO NOT connect speaker ground wires to the chassis of the vehicle.

DO NOT connect front and rear speaker wires together.

FAILURE TO FOLLOW ANY OF THESE WARNINGS WILL RESULT IN DAMAGE TO THIS UNIT AND VOIDS THE WARRANTY.

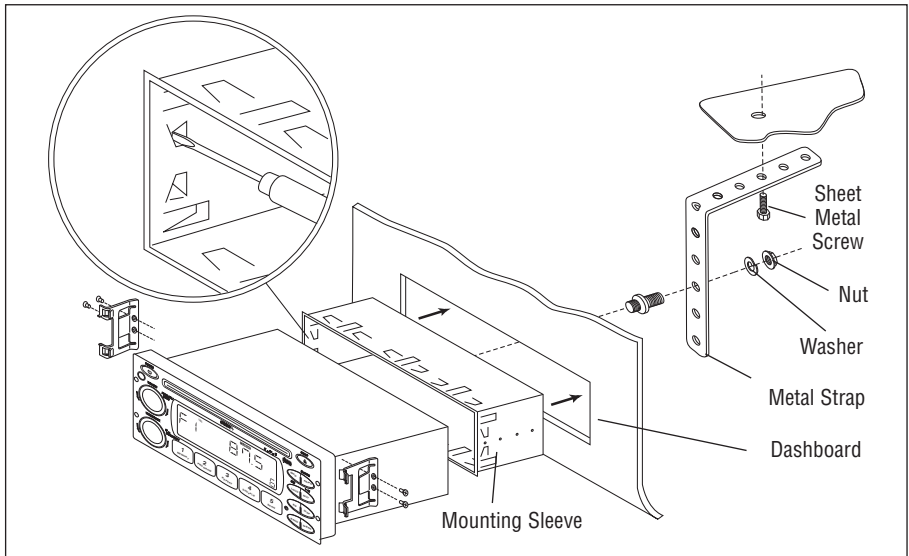

Connection

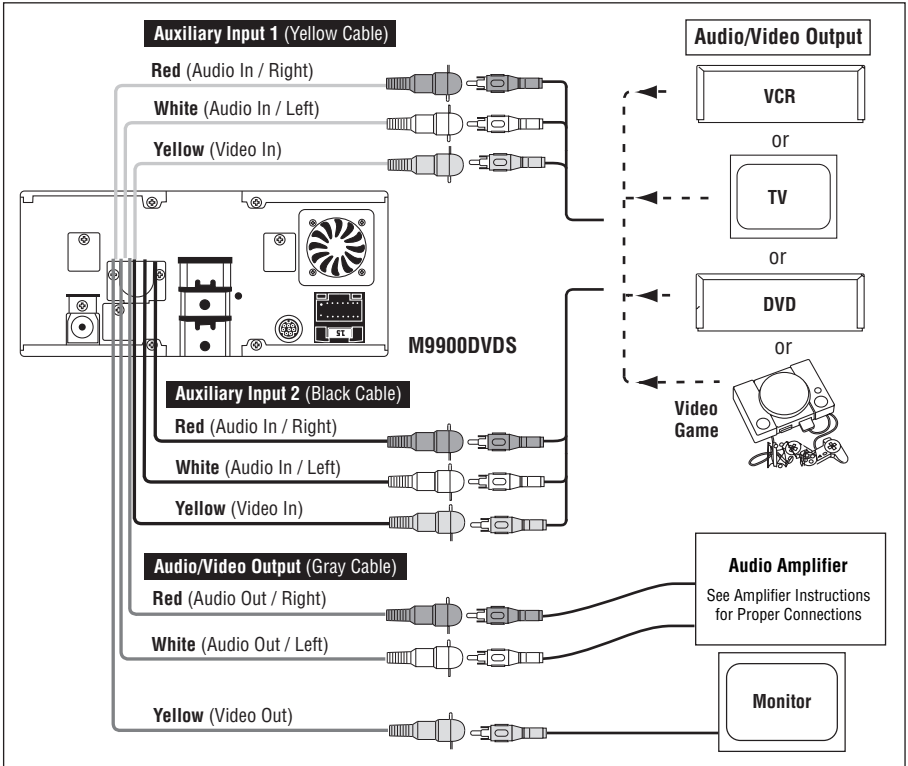
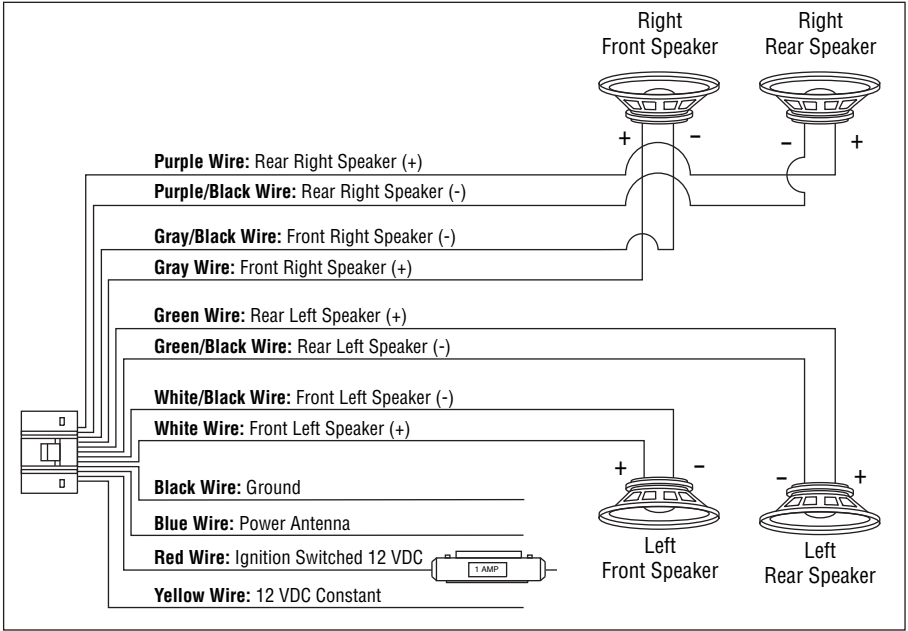

Sirius Tuner Connection (Optional)

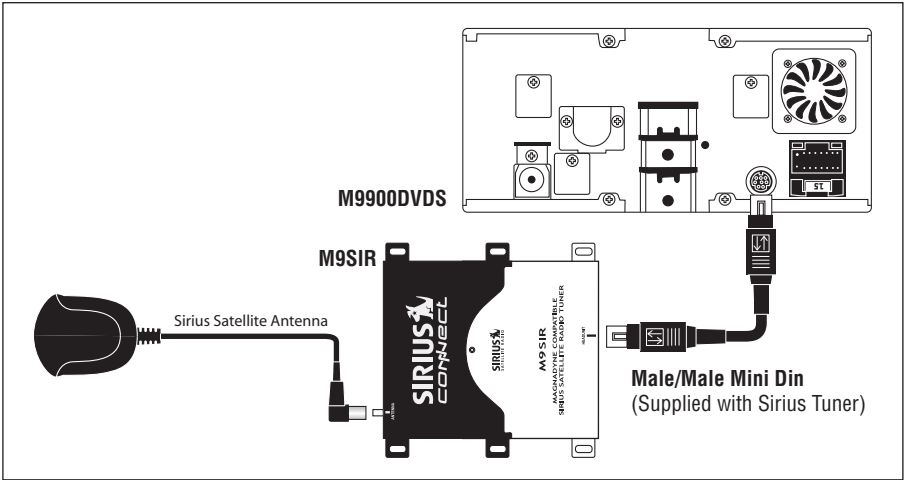

CD Changer Connection (Optional)

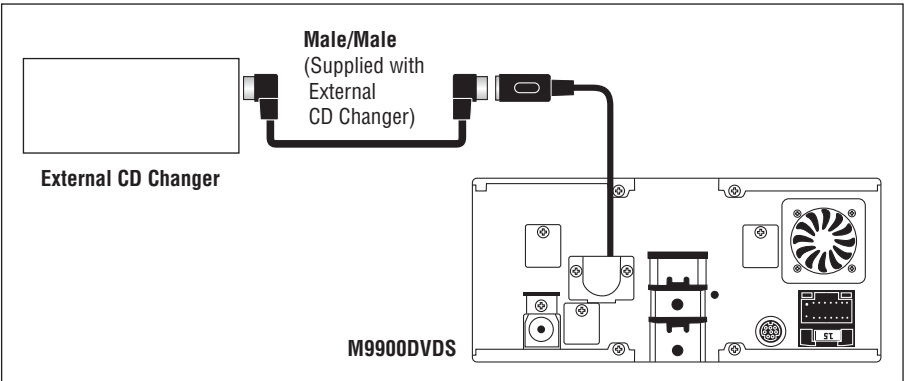

Remote IR Sensor Connection (Optional)

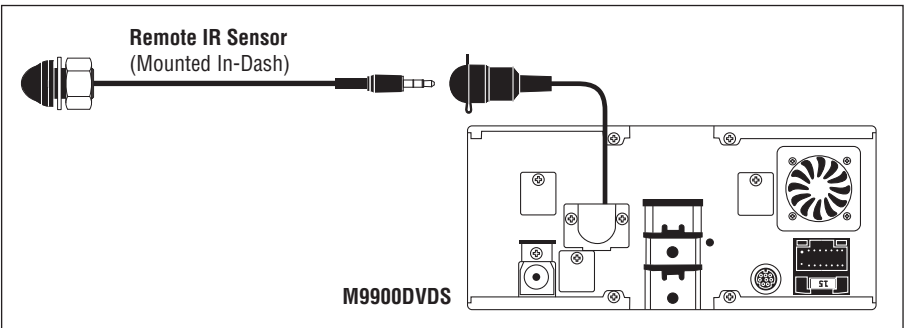

Antenna Connection

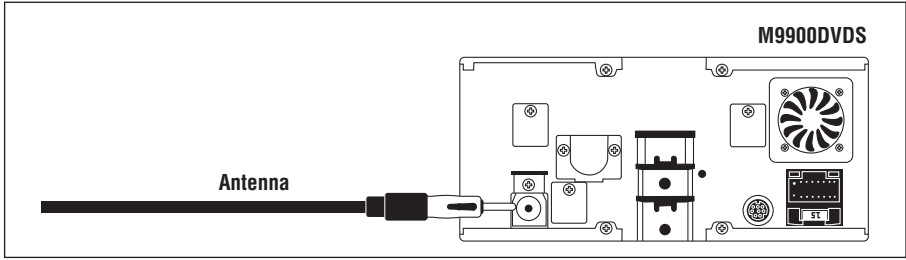

Trouble Shooting

If it appears that your DVD unit is faulty, first consult the checklist below. It may be that something simple has been overlooked. Under no circumstance should you try to repair the player yourself, as this will invalidate the warranty. Only qualified service personnel should remove the cover or service this player.

No Power:

- If the power supply is connected to the car accessory circuits, but the engine is not running, switch the ignition key to "ACC".
- Check if the fuse is blown. If so, replace it with a new fuse of the same value.
- Check if the Power On/Off button is set to on.

No Picture:

- Check if the monitor or TV is switched on.
- Check if DVD mode is selected.
- Check the video connection.

Distorted Picture:

- Check the disc for debris and clean with soft cloth, wiping from the center to the edge.
- Sometimes a small amount of picture distortion may appear. This is not a malfunction.

Completely Distorted Picture:

- The disc format is not set according to the TV set used (PAL/NTSC).

No Color in Picture:

- The disc format is not set according to the TV set used (PAL/NTSC).

Disc Does Not Play:

- Ensure that the disc was inserted label up.
- Clean the disc.
- Check if the disc is defective by trying another disc.

The Player Does Not Respond to the Remote Control:

- Aim the remote control directly at the infrared sensor on the front of the player.
- Avoid all obstacles which may interfere with the signal path.
- Inspect or replace the remote control battery.

Distorted or B/W Picture:

- The disc format is not set according to the TV set used (PAL/NTSC).

Buttons Do Not Work:

- Press the RESET button on the front panel of the radio.

The Radio Does Not Work:

- Check if the antenna cable is properly connected.

The Radio Station Automatic Selection Does Not Work:

- The signals maybe too weak, select a station manually.

Order-By-Mail Replacement Parts

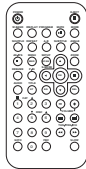
| | DESCRIPTION | MODEL # | PRICE |
|---|--------------------------|-----------|-------------|
|  | M9900DVDS Remote Control | RC9900DVD | \$39.95 ea. |

Specifications

General:

| | |
|----------------------------|----------------------------------|
| Power Supply Requirements: | DC 12 Volts, Negative Ground |
| Chassis Dimensions: | 180mm (W) x 160mm (D) x 80mm (H) |
| Tone Controls | |
| Bass (at 100 Hz) | ±10 dB |
| Treble (at 10 kHz) | ±10 dB |
| Maximum Output Power | 4 x 40 Watts |
| Current Drain | 15 Ampere (max.) |

CD Player:

| | |
|------------------------|-----------------|
| Signal to Noise Ratio: | More than 55 dB |
| Channel Separation: | More than 45 dB |
| Frequency Response: | 20Hz - 20kHz |

Radio:

FM

| | |
|--------------------------|-------------------|
| Frequency Coverage: | 87.5 to 107.9 MHz |
| IF | 10.7MHz |
| Sensitivity (S/N = 30dB) | 12 dBu |
| Stereo Separation | > 25 dB |

AM

| | |
|--------------------------|-----------------|
| Frequency Coverage: | 530 to 1720 kHz |
| IF | 450 kHz |
| Sensitivity (S/N = 20dB) | 36 dBu |

WB

| | |
|--------------------------|----------------------|
| Frequency Coverage: | 162.40 to 162.55 MHz |
| IF | 10.7MHz |
| Sensitivity (S/N = 30dB) | 15 dBu |

Note: Due to improvement in technology, specifications and design are subject to change without notice.

Replacement Parts Order Form

Send Orders To: Magnadyne Corporation
 ATTN: Consumer Parts Sales
 P.O. Box 5365
 Carson, CA 90749-5365

We Accept Checks, Money Orders, Visa and Master Card
Make Checks Payable to: Magnadyne Corporation

SHIP TO: (No P.O. Boxes)

LAST NAME

FIRST NAME

INITIAL

STREET ADDRESS (IF PAYING WITH A CREDIT CARD, YOUR BILLING ADDRESS IS REQUIRED)

CITY

STATE

ZIP CODE

DAYTIME PHONE NUMBER

CREDIT CARD INFORMATION:

CARD TYPE: VISA MASTER CARD

CARD NUMBER

EXP. MONTH

YEAR

NAME - EXACTLY AS IT APPEARS ON YOUR CREDIT CARD

| Part # | Description | Qty. | Price Each | TOTAL |
|-----------|----------------|------|------------|-------|
| RC9900DVD | Remote Control | | \$39.95 | |

Shipping and Handling

| Subtotal + Tax | Add |
|----------------|--------|
| Up to \$20.00 | \$5.00 |
| 20.01 to 30.00 | 5.95 |
| 30.01 to 45.00 | 6.50 |
| 45.01 to 70.00 | 6.95 |
| Over 70.01 | 7.95 |

Subtotal = _____ . _____

California Residents Add Sales Tax = _____ . _____

Shipping and Handling (See Chart) = _____ . _____

TOTAL = _____ . _____

No C.O.D.'s

On regular orders please allow 4-5 weeks for delivery. Please give a shipping address where this order may be delivered between the hours of 9 a.m. and 5 p.m. weekdays. If UPS is unable to deliver, your order will be returned and additional shipping charges will be required.

Warranty

ONE (1) YEAR LIMITED WARRANTY

Magnadyne Corporation or its authorized agents will within 1 year from the date of sale to you, repair, replace or refund the retail sales price of said product or any part thereof, at the option of the Magnadyne Corporation or its authorized agents, if said product or part is found defective in materials or workmanship, when properly connected and operating on the correct power requirements designated for the specific product. This warranty and Magnadyne Corporation or its authorized agents obligations hereunder do not apply where the product was; damaged while in the possession of the consumer, subjected to unreasonable or unintended use, not reasonably maintained, utilized in commercial or industrial operations, or serviced by anyone other than Magnadyne Corporation or its authorized agents, or where the warning seal on the product is broken or the power and/or plugs are detached from the unit. Magnadyne Corporation or any of its authorized agents will not assume any labor costs for the removal and re-installation of any product found to be defective, or the cost of transportation to Magnadyne Corporation or its authorized agents. Such cost are the sole responsibility of the purchaser.

This warranty does not cover the cabinet appearance items or accessories used in connection with this product, or any damage to recording or recording tape, or any damage to the products resulting from improper installation, alteration, accident, misuse, abuse or acts of nature.

MAGNADYNE CORPORATION OR ITS AUTHORIZED AGENTS SHALL NOT BE LIABLE TO ANYONE FOR CONSEQUENTIAL OR INCIDENTAL DAMAGES OR CLAIMS EXCEPT THOSE ACCORDED BY LAW. NO EXPRESSED WARRANTY OR IMPLIED WARRANTY IS GIVEN EXCEPT THOSE SET FORTH HEREIN. NO IMPLIED WARRANTY SHALL EXTEND BEYOND 1 YEAR FROM THE DATE OF SALE.

This warranty extends only to the original purchaser of the product and is not transferable.

Some states do not allow limitations on how long an implied warranty lasts and some states do not allow the exclusion or limitation of incidental or consequential damages, so the above limitations or exclusion may not apply to you. This warranty gives you specific legal rights and you may have other rights that vary from state to state.

Defective merchandise should be returned to the original point of purchase or secondly, to Magnadyne Corporation, 1111 W. Victoria Street, Compton CA 90220. Return Authorization must be obtained before sending, or merchandise may be refused.