

Elan

90 Ceramic

with Glide-out™ grill

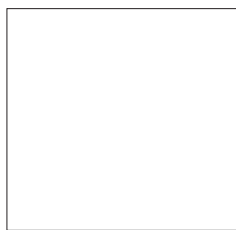

Users Guide

Installation & Service Instructions

U109650-02



www.rangemaster.co.uk

Be safe

Warning

Accessible parts will become hot in use. To avoid burns and scalds children should be kept away.

Do not stand or rest heavy objects on the hob. Although the ceramic surface is very strong, a sharp blow or sharp falling object might cause the surface to crack. As soon as any crack in the surface becomes visible disconnect the appliance **immediately** from the supply and arrange for its repair. Care should be taken that no water seeps into the appliance.

During use, and afterwards, the appliance will be warm, so be careful with little children. If the younger members of your family are allowed into the kitchen we strongly advise that they are kept under supervision at all times.

If you have not used a ceramic electric cooker before, we recommend you read the 'General Safety Instructions' where we describe some basic guidelines on how to use your cooker safely.

Electricity on

Make sure that the electricity supply is turned on

Peculiar smells

When you first use your cooker it may give off a slight odour. This should stop after a little use.

Before using for the first time, make sure that all packing materials have been removed and then to dispel manufacturing odours, turn the ovens to 230°C and run for an hour.

Before using the grill for the first time you should also turn on the grill and run for 30 minutes with the grill pan in position, pushed fully back, and the grill door open.

Make sure the room is well ventilated to the outside air, by opening windows or turning on a cooker hood for example. We recommend that people with respiratory or allergy problems should vacate the area for this brief period.

Installation

This appliance must be installed by a qualified electrician to comply with the relevant regulations and also the local electricity supply company requirements. Read the instructions before installing or using this appliance.

Contents

The Hob	Page 4
The Glide-out™ Grill	Page 6
The Ovens	Page 7
The Clock	Page 8
Both Ovens	Page 10
Multi-function oven	Page 11
Handyrack	Page 12
Main Oven shelves	Page 13
Tall Oven shelves	Page 13
Multi-function Oven cooking guide	Page 14
Oven Cooking chart - Conventional and full Fan oven functions	Page 15
Cleaning your cooker	Page 16
Moving your cooker	Page 18
Troubleshooting	Page 20
General Safety Instructions	Page 22
Installation	Page 24
Servicing Notes	Page 28
Circuit Diagram	Page 33
Technical Data	Page 34

The Hob

When you cook on a ceramic hob its very important to use the right sort of pans...

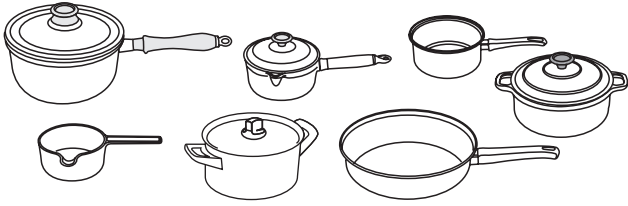

Use only pans that are suitable for ceramic hobs. **We recommend stainless steel and enamelled steel pans because pots and pans with copper or aluminium bases leave traces on the hob that are difficult to remove.**

Glass-ceramic cookware is not suitable because of its poor conductivity.

1 Pots and pans should have thick, smooth, flat bottoms. This ensures that there is the maximum heat transfer from the hob to the pan, making cooking quick and energy efficient.

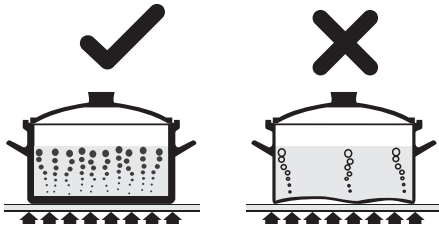

Never use a round bottomed Wok even with a stand.

2 The very best pans have bases that are very slightly curved in when cold. If you hold a ruler across the bottom you will see a small gap in the middle. When they heat up the metal expands and lies flat on the cooking surface.

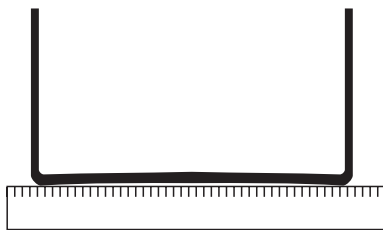

Make sure that the base of the pan is clean and dry to prevent any residue burning onto the hob panel. This also helps prevent scratches and deposits (such as lime specks).

3 Always use pans that are the same size as (or slightly larger than) the areas marked on the hob top. Using smaller pans wastes heat, and any spillage will be burnt on. Using a lid will help the contents boil more quickly.

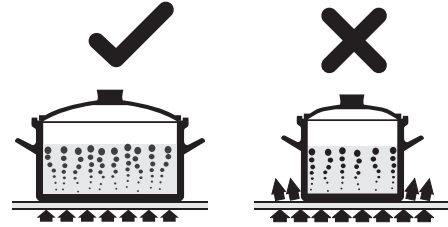

4 Always lift pans off the hob. Sliding pans may cause marks and scratches. Always turn the control to the off position before removing a pan.

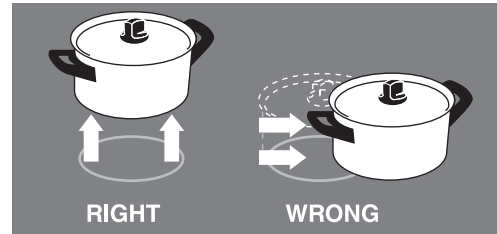

5 There are indicator lights for each of the cooking areas. These come on when a hob control is turned on and stay lit while the surface cools. Always take care before touching the surface even when it is turned off - it may be hotter than you think.

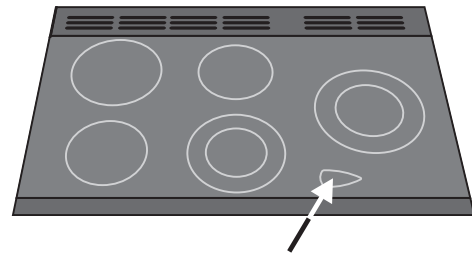

6 The ratings of the cooking areas are shown on the diagram below.

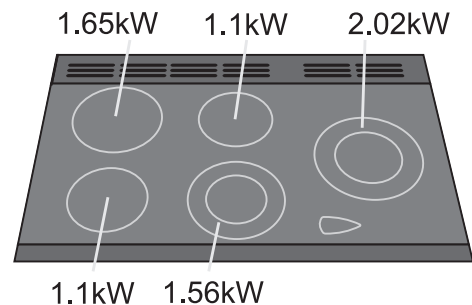

7 Although the ceramic surface is very strong, a heavy or sharp falling object (a salt cellar for example) might cause the surface to crack. If you find a crack in the surface **immediately** disconnect the appliance from the supply and arrange for its repair.

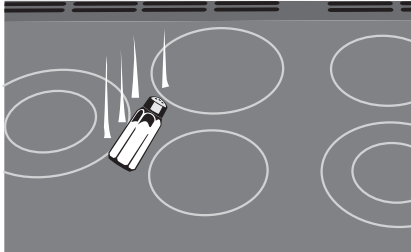

Care should be taken that no water seeps into the appliance.

8 The areas marked with two concentric circles have an inner and an outer element.

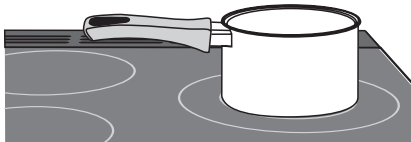

Turn the control knob clockwise to heat the whole area for larger pans - turn it the other way to just heat the inner part for smaller pans.

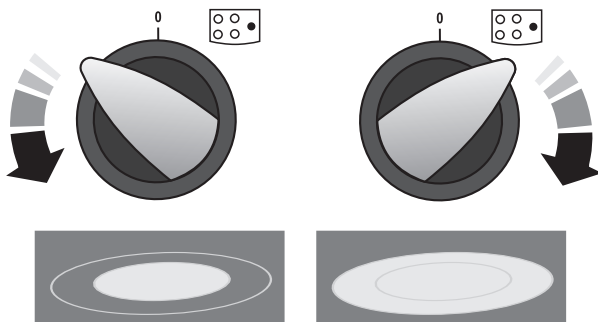

10 Never cook directly on the surface.

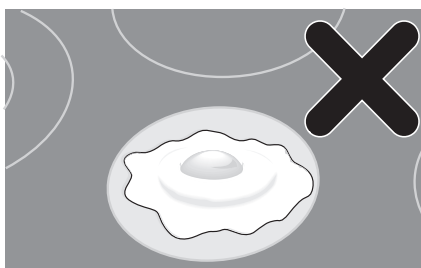

The kind of pan you use and the quantity of food affects the setting required. Higher settings are required for larger quantities of food.

Naturally, the surface must be washed after use in order to prevent it from becoming scratched or dirty.

Only scratches in the hob surface reported within 14 days of cooker installation are covered by the guarantee. Scratches caused by usage are not covered.

When cooking on the hob you may see the hob area you are using switch off and on. This is caused by a safety device that limits the temperature of the hob. It is quite normal, especially when cooking at high temperatures. If it happens a lot with a particular pan however it may mean the pan is not suitable – perhaps too small or too uneven - for a ceramic hob.

Sugar spillage will permanently damage the hob and therefore must be cleaned off with care immediately. Never let sugar spillage cool before trying to remove it.

If sugar or foods with high sugar content, aluminium foil or plastic items are accidentally allowed to melt on the hob surface remove them immediately from the hot cooking area using a scraper to avoid any possible damage to the surface. See the 'Cleaning your cooker' section of these instructions.

Never cut directly on the cooking surface.

Don't cook directly on the hob surface i.e. without a pan or utensil

Don't use the hob as a work surface

Don't drag or slide utensils across the hob surface

Don't place anything between the base of the pan and the hob surface (i.e. asbestos mats, aluminium foil, Wok stand)

Don't leave utensils, foodstuffs or combustible items on the hob when it is not in use. (e.g. tea towels, frying pans containing oil)

Don't place plastic or aluminium foil, or plastic containers on the hob

Don't leave the hob zones switched on unless being used for cooking

Don't place large preserving pans or fish kettles across two heating zones

Don't place utensils partly covering a heating zone. Always place utensils centrally.

The Glide-out™ Grill

Caution: Accessible parts may be hot when the grill is in use. Young children should be kept away.

Before using the grill for the first time, make sure that all packing materials have been removed and then to dispel manufacturing odours, turn on the grill and run for 30 minutes with the grill pan in position, pushed fully back, and the grill door open.

Make sure the room is well ventilated to the outside air, by opening windows or turning on a cooker hood for example. We recommend that people with respiratory or allergy problems should vacate the area for this brief period.

Using the grill

1 Open the grill door and pull the grill pan carriage forward using the handle.

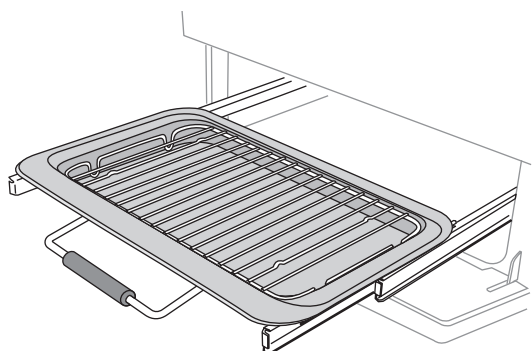

The grill pan gets very hot when the grill is on. Don't touch the pan or trivet unless you are sure it is cool.

2 After placing your food on the grill grid, slide the grill carriage into the grill chamber. Make sure it is pushed right in.

The grill has two elements that allow either the whole area of the pan to be heated or just the right hand half. To heat the whole grill, turn the knob clockwise.

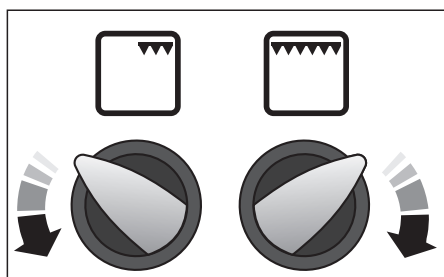

To heat the right hand half turn it anticlockwise.

The neon indicator light by the grill control will come on.

3 For best results preheat for 2 minutes with the grill pan in position. After placing your food on the grill pan grid, slide in the grill carriage. Adjust the heat to suit by turning the knob.

Make sure the grill carriage is pushed right in.

Never close the grill door when the grill is on.

4 The grill pan grid can be turned over to give two grilling positions.

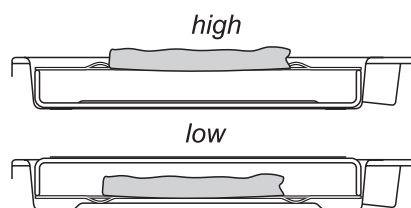

Don't leave the grill on for more than a few moments, without the grill pan underneath it.

For best results, especially with toast, preheat the grill with the grill pan in the cooking position for two minutes before use.

Before you remove any of the grill parts for cleaning make sure that they are cool or use oven gloves.

The grill trivet can be removed and the food placed on it while you are waiting for the grill to preheat.

The grill pan and grill pan carriage can be easily removed for cleaning. See the '**Cleaning your cooker**' section of these instructions.

When you pull the grill pan forward is the wide rim at the front? It's important that the wider part is at the front.

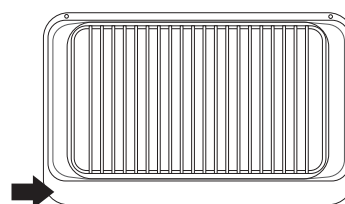

The Ovens

During use the appliance becomes hot. Care should be taken to avoid the touching heating elements inside the oven.

Before using for the first time, to dispel manufacturing odours turn the ovens to 230°C and run for an hour. To clear the smell, make sure the room is well ventilated to the outside air, by opening windows or turning on a cooker hood for example. We recommend that people with respiratory or allergy problems should vacate the area for this brief period.

The clock must be set to the time of day before the ovens will work. See 'The Clock' section for instructions on setting the time of day.

The Left Hand Oven

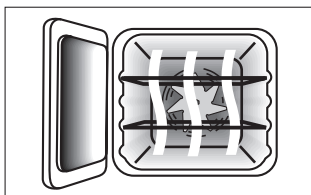

The left hand oven is a Multi-function oven. As well as the oven fan and fan element, it is fitted with two extra heating elements, one visible in the top of the oven and the second under the oven base. Take care to avoid touching the top element and element deflector when placing or removing items from the oven. For more detail on this oven see the section 'Multi-function oven'.

The Right Hand Tall Oven

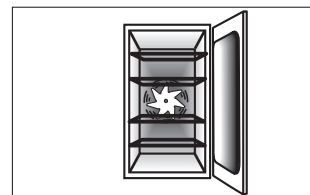

The fan in the right hand oven circulates hot air continuously, which means faster more even cooking. The recommended cooking temperatures for a fanned oven are generally lower than a non-fanned oven.

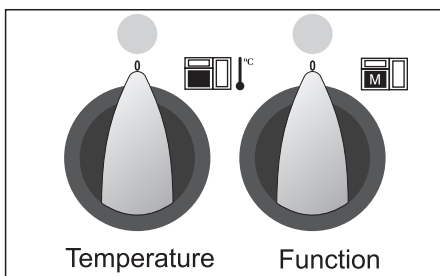

The Multi-function oven has two controls, a function selector and a temperature setting knob.

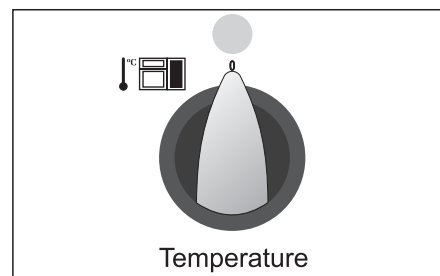

The right hand fan oven control is at the right hand end of the control panel.

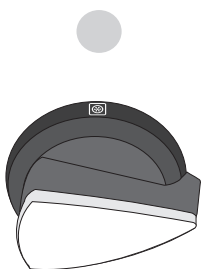

Turn the function selector control to a cooking function. This is the fan oven setting.

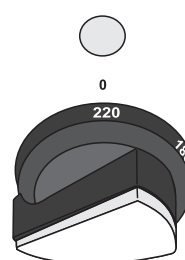

Turn the oven temperature knob to the temperature you need.

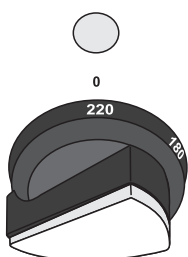

Turn the oven temperature knob to the temperature you need.

The oven heating light will glow until the oven has reached the temperature you selected. It will then cycle on and off during cooking.

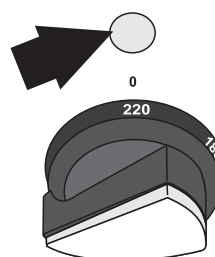

The oven indicator light will glow until the oven has reached the temperature you selected. It will then cycle on and off during cooking.

The Clock

You can use the timer to turn the ovens on and off. The clock must be set to the time of day before the ovens will work.

Setting the time of day

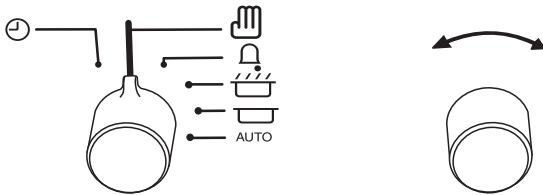

Timer knob

Adjusting knob

When the clock is first connected the display will flash (0.00) and () alternately.

<p>To set the clock to read the time of day turn and hold the Timer knob to the clock symbol ().</p>	
-------------------------------------------------------------------------------------------------------------------------------------------------------------------------------------------	--

<p>At the same time turn the Adjusting knob left or right until the clock shows the time of day.</p>	
------------------------------------------------------------------------------------------------------	--



Let go of the Timer knob and it will spring back to the vertical () oven manual setting.

If the key symbol () appears on the left of the display you have accidentally turned on the key lock feature. See the section 'Clock Special Features'.

To time something that's cooking (minute minder)

<p>Turn the Timer knob to the right to the () minute minder setting - it should click into position.</p>	
-----------------------------------------------------------------------------------------------------------------------------------------------------------------------------------------------	--

<p>Use the Adjusting knob to set the time you need.</p>	
---------------------------------------------------------	--

You can turn the knob back to the () manual setting to keep an eye on the time of day or leave it in the () minute minder position as the time ticks down.

To stop the beeper when it sounds

Turn the Adjusting knob anticlockwise

To stop automatically

Use when you have started the oven manually.

<p>Turn the Timer knob to the () position. Use the Adjusting knob to set the time you need.</p>	
-------------------------------------------------------------------------------------------------------------------------------------------------------------------------------------------	--

<p>'Stop Time' shows. AUTO will show in the display.</p>	
--------------------------------------------------------------	--

Turn the Timer knob to the () setting.

When your cooking is finished the beeper sounds. Turn the Timer knob to the vertical () to return to manual cooking.

To start & stop the oven automatically

Before you set the clock, you must have two numbers clearly in mind.

The **'cook time'**, which is the period of time you want the oven to cook.

The **'stop time'**, which is the time of day you want the oven to stop cooking.

You cannot set a start time directly - this is set automatically by setting the cooking period and stop time.

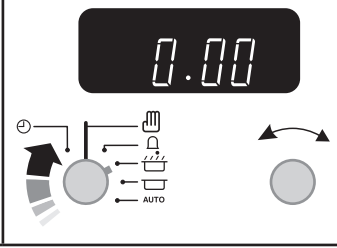
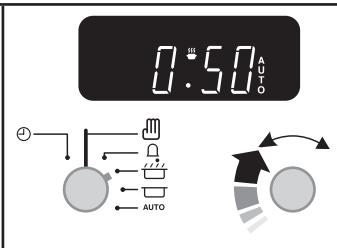
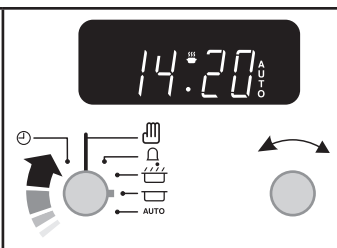
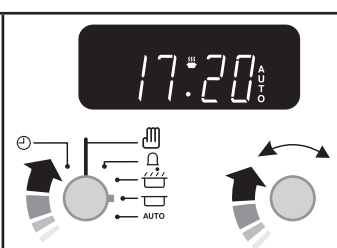
<p>Turn the Timer knob to the (🕒) position.</p>	
<p>Use the Adjusting knob to set the 'cooking time' you need.</p>	
<p>Turn the Timer knob to the (🕒) position. The display will show the current time of day plus the 'cook period' you just set.</p>	
<p>Use the Adjusting knob to set the 'Stop time' you need. 'Stop Time' shows. AUTO will show in the display.</p>	

Set the oven(s) to the cooking temperature you need (don't forget to set a function if using the Multi-function oven).

Turn the Timer knob to the (AUTO) setting.

When your cooking is finished the beeper sounds. Turn the Timer knob to the vertical (🕒) to return to manual cooking.

If you are out, don't worry about the beeper going off, it stops after a while. When you return, turn the Timer knob to the vertical (🕒) position to return to manual cooking. Turn the thermostat to the off position.

AUTO is showing, you want to reset to manual cooking.

You can cancel any automatic settings by turning the Timer knob to the vertical manual symbol (🕒).

Clock Special Features - Key Lock

When the key lock is activated, the clock can be operated as usual but the ovens are locked and will not come on. This means that your child could select a cook program but the program will not be activated and ovens will not switch on.

To activate the key lock

Make sure that the clock is in manual mode and cancel any active programs.

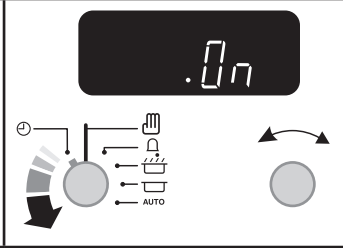
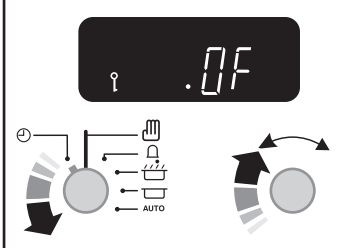
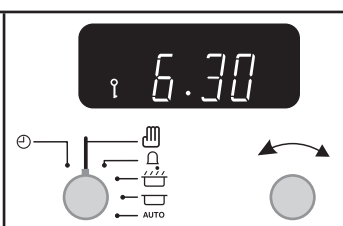
<p>Turn and hold the Timer knob to the clock symbol (🕒) for about 8 seconds. 'On' will appear on the display.</p>	
<p>Keep holding the Timer knob turned to the clock symbol (🕒) and turn the Adjusting knob clockwise until the key symbol (🔑) and 'Of' shows on the display. Let go of the knobs</p>	
<p>The ovens are now locked. After a few seconds the display will revert to show the time of day and the key symbol.</p>	

To turn off the key lock

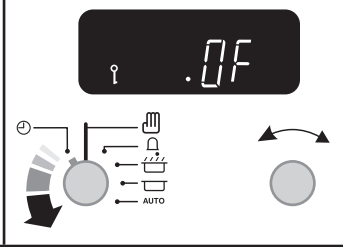
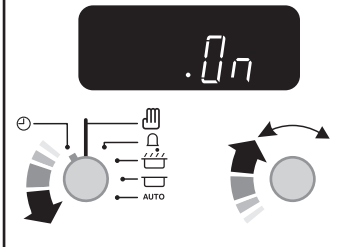
<p>Turn and hold the Timer knob to the clock symbol (🕒) for about 8 seconds. 'Of' will appear on the display.</p>	
<p>Keep holding the Timer knob turned to the clock symbol (🕒) and turn the Adjusting knob clockwise until the key symbol (🔑) goes out on the display and 'On' shows. Let go of the knobs.</p>	

Both Ovens

After a few seconds the display will revert to show the time of day.

The ovens can now be used normally.

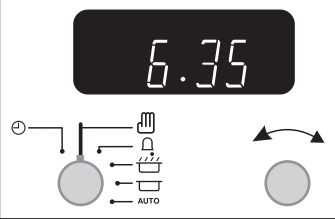

The wire shelves should always be pushed firmly to the back of the oven.

Baking trays, meat tins et cetera should be placed level and centrally on the oven's wire shelves. Keep all trays and containers away from the sides of the oven, as overbrowning of the food may occur.

For even browning maximum recommended size for a baking tray is:-

Main oven	340mm (13 ³ / ₈ ") by 340mm (13 ³ / ₈ ").
Tall oven	230mm (9") by 320mm (12 ¹ / ₂ ").

Cooking high moisture content foods can create a 'steam burst' when the oven door is opened. When opening the oven stand well back and allow any steam to disperse.

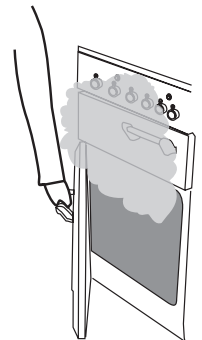

When the oven is on, don't leave the door open for longer than necessary, otherwise the knobs may get very hot.

- Always leave a 'fingers width' between dishes on the same shelf. This allows the heat to circulate freely around them.
- The Cook & Clean oven liners (see *Cleaning your cooker*) work better when fat splashes are avoided. Cover meat when cooking.



- To reduce fat splashing when you add vegetables to hot fat around a roast, dry them thoroughly or brush lightly with cooking oil.
- Sufficient heat rises out of the oven while cooking to warm plates in the grill compartment.
- If you want to brown the base of a pastry dish, preheat a baking tray for 15 minutes before placing the dish in the centre of the tray.
- Where dishes may boil and spill over during cooking, place them on a baking tray.

Cooking using the timer

The timer can be used to turn just one oven or both on and off automatically. The start and stop time must be the same for both ovens but different cooking temperatures can be set.

If you want to turn one of the ovens on at the same time as the timer is set for automatic cooking, you must wait until the timer has turned on the oven/ ovens first. Then you can adjust either of them manually in the normal way.

You can set the oven to turn on any time over the following 24 hour period.

If you want to cook more than one dish, choose dishes that require approximately the same time. However, dishes can be 'slowed down' slightly by using small containers and covering them with aluminium foil, or 'speeded up' slightly by cooking smaller quantities or placing in larger containers.

Very perishable foods such as pork or fish should be avoided if a long delay period is planned, especially in hot weather.

Don't place warm food in the oven.

Don't use an oven already warm.

Don't use if an adjoining oven is warm.

Avoid using wine or beer if there is a delay period, as fermentation may take place.

To avoid curdling, cream should be added to dishes just before serving.

Fresh vegetables, which may discolour during a delay period, should be coated in melted fat or immersed in a water and lemon juice solution.

Fruit pies, custard tarts or similar wet mixtures on top of uncooked pastry are only satisfactory if there is a short delay period. Dishes containing leftover cooked meat or poultry should not be cooked automatically if there is a delay period.

Whole poultry must be thoroughly defrosted before placing in the oven.

Check that meat and poultry are fully cooked before serving.

Multi-function oven

The Multi-function oven is on the left hand side. It has many varied uses. We suggest you keep a careful eye on your cooking until you are familiar with each function. Remember - not all functions will be suitable for all food types.

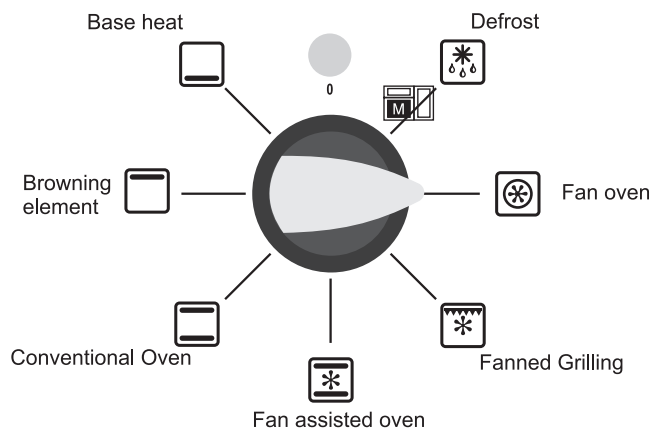

Please remember that all cookers vary - temperatures in your new Elan ovens may differ to those in your previous cooker.

Multi-function oven functions



Defrost

This function operates the fan to circulate cold air only. No heat is applied. This enables small items such as desserts, cream cakes and pieces of meat, fish and poultry to be defrosted.

Defrosting in this way speeds up the process and protects the food from flies. Pieces of meat, fish and poultry should be placed on a rack, over a tray to catch any drips. Be sure to wash the rack and tray after defrosting.

Defrost with the oven door closed.

Large items, such as whole chickens and joints should not be defrosted in this way. We recommend this be carried out in a refrigerator.

Defrosting should not be carried out in a warm oven or when an adjoining oven is in use or still warm.

Ensure that dairy foods, meat and poultry are completely defrosted before cooking.



Fan oven

This function operates the fan and the heating element around it. An even heat is produced throughout the oven, allowing you to cook large amounts quickly.

Fan oven cooking is particularly suitable for baking on several shelves at one time and is a good 'all-round' function. It may be necessary to reduce the temperature by approximately 10°C for recipes previously cooked in a conventional oven.

If you wish to pre-heat the oven, wait until the indicator light has gone out before inserting the food.



Fanned grilling

This function operates the fan whilst the top element is on. It produces a more even, less fierce heat than a conventional grill. For best results, place the food to be grilled, on a grid over a roasting tin, which should be smaller than a conventional grill pan. This allows greater air circulation. Thick pieces of meat or fish are ideal for grilling in this way, as the circulated air reduces the fierceness of the heat from the grill. The oven door should be kept closed whilst grilling is in progress, so saving energy. You will also find that the food needs to be watched and turned less than for normal grilling. Pre-heat this function before cooking.



Fan assisted oven

This function operates the fan, circulating air heated by the elements at the top and the base of the oven. The combination of fan and conventional cooking (top and base heat) makes this function ideal for cooking large items that need thorough cooking, such as a large meat roast. It is also possible to bake on two shelves at one time, although they will need to be swapped over during the cooking time, as the heat at the top of the oven is greater than at the base, when using this function.

This is a fast intensive form of cooking; keep an eye on the food cooking until you have become accustomed to this function.

Handyrack



Conventional oven (top and base heat)

This function combines the heat from the top and base elements. It is particularly suitable for roasting and baking pastry, cakes and biscuits. Food cooked on the top shelf will brown and crisp faster than on the lower shelf, because the heat is greater at the top of the oven than at the base, as in 'Fan assisted oven' function. Similar items being cooked will need to be swapped around for even cooking. This means that foods requiring different temperatures can be cooked together, using the cooler zone in the lower half of the oven and hotter area to the top.



Browning element

This function uses the element in the top of the oven only. It is a useful function for the browning or finishing of pasta dishes, vegetables in sauce, shepherds pie and lasagne, the item to be browned being already hot before switching to the top element.



Base heat

This function uses the base element only. It will crisp up your pizza or quiche base or finish off cooking the base of a pastry case on a lower shelf. It is also a gentle heat, good for slow cooking of casseroles in the middle of the oven or for plate warming.

The Browning and Base heat functions are useful additions to your oven, giving you flexibility to finish off items to perfection. With use, you will soon realise how these functions can combine to extend your cooking skills.

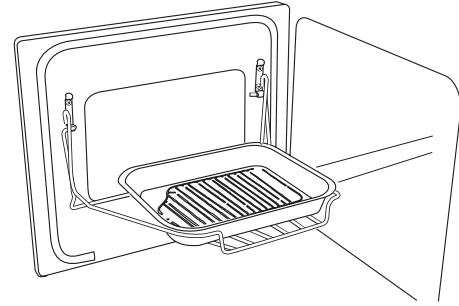

The maximum weight than can be held by the Handyrack is 5.5kg (12lb). It should only be used with the supplied meat tin, which is designed to fit the Handyrack. Any other vessel could be unstable.

The Handyrack fits on the Main oven door. Food cooking on it is easy to attend to, because it's accessible when the door is open. It can be fitted at two different heights. One of the oven shelves must be removed and the other positioned to suit.

When the Handyrack is used in its highest position, other dishes can be cooked on the bottom shelf position of the oven.

When the Handyrack is used in its lowest position, other dishes can be cooked on the second shelf position of the oven.

To fit the Handyrack, locate one side of it on the door bracket.

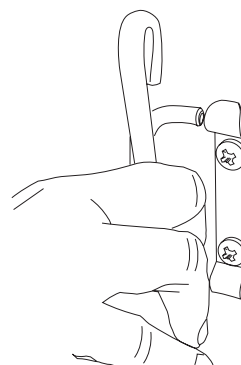
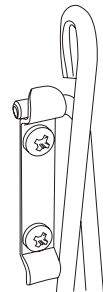

Then spring the other side out to clip it onto the other bracket.

Main Oven shelves

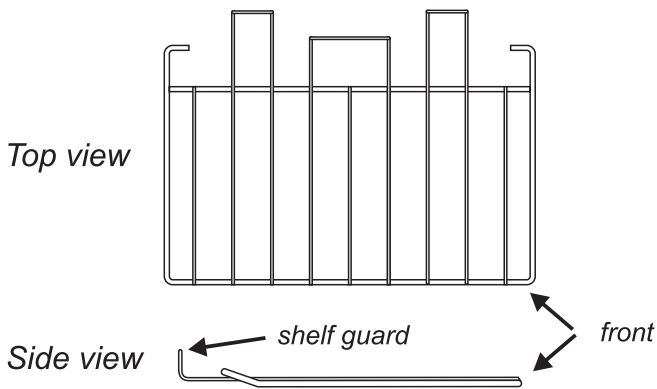

the shelf guard should be at the back pointing upwards
As well as a flat shelf some models are supplied with a drop shelf. The drop shelf increases the possibilities for oven shelf spacing.

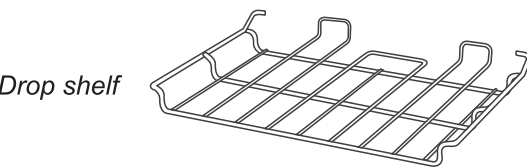
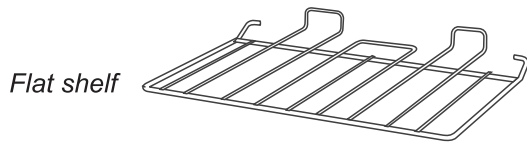

The oven shelves can be easily removed and refitted.

Pull the shelf forward until the back of the shelf is stopped by the shelf stop bumps in the oven sides.

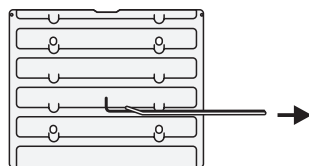

Lift up the front of the shelf so the back of the shelf will pass under the shelf stop and then pull the shelf forward.

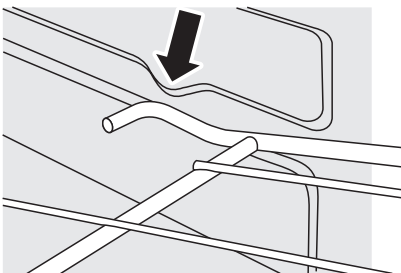
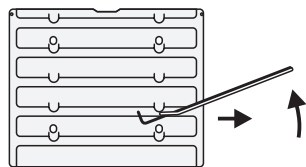

To refit the shelf, line up the shelf with a groove in the oven side and push the shelf back until the ends hit the shelf stop. Lift up the front so the shelf ends clear the shelf stops, and then lower the front so that the shelf is level and push it fully back.

Tall Oven shelves

The tall oven is supplied with four normal cooking shelves

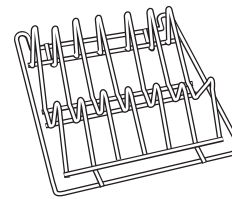
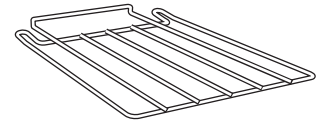

and a plate warming shelf.

When using the tall oven you can cook on all four shelves at the same time; but make sure they are well spaced out to allow the hot air to circulate.

Steam

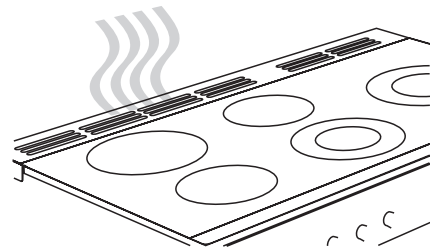

During cooking, food naturally produces steam, particularly when cooking foods with high water content (e.g. oven chips). There may be some steam visible at the grille at the rear of the hotplate. This is perfectly normal.

As this steam can condense to water droplets on the cool outer trim of the oven, it may be necessary during cooking to wipe away any moisture with a soft cloth. This will also help to prevent soiling and discolouration of the oven exterior by cooking vapours.

Oven light



Press the appropriate button to turn on one of the oven lights.

If one of the oven lights fail, **turn off the power supply** before you change the bulb. See the 'Troubleshooting' section for details on how to change an oven light bulb.

Multi-function Oven cooking guide

Remember - not all functions will be suitable for all food types. The oven control settings and cooking times given are intended to be used only as a guide. Individual tastes may require the temperature to be altered to provide a preferred result.

Food is cooked at lower temperature in a fan oven than in a conventional oven. When using recipes, reduce the temperature by 10°C and the cooking time by 5-10 minutes. The temperature in the fanned oven does not vary with height in the oven - so you can use any shelf.

The shelves should not be fitted directly one above the other. When cooking on more than one shelf always leave at least one runner space between them. Place baking trays, individual cake tins or baking dishes centrally on the oven shelf. For best results pre-heat the oven until the oven indicator light goes out.

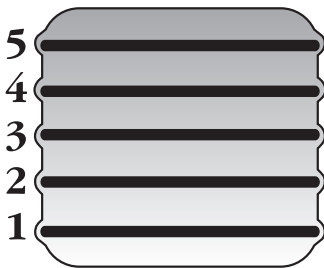

Cooking chart - Fan assisted oven function

Food	Temp	Oven Shelf Position	Approximate Cooking Time
Fairy cake	170°C	2-4	20 min
Scone	180°C	2-4	15 min
Deep apple pie	160°C	2-4	45 min interchange after 25 minutes
Plate tart	190°C	2-4	45 min interchange After 25 minutes
Rich fruit cake 197mm x 92mm	145°C	3	1 hr 45 min - 2 hr
Victoria sandwich 180mm	170°C	2-4	20 - 25 min
Milk pudding	150°C	3	2 hrs
Puff pastry	220°C	3 - 5	15-40 mins according to size. Interchange 2/3rds through cooking time

For roast meats and poultry refer to the Fan oven guide - reduce cooking time slightly.

500g is approximately 1lb (1lb 2oz)

Ensure meat and poultry is fully cooked before serving

Oven Cooking chart - Conventional and full Fan oven functions



Food	Convection Oven		Fan Oven	Approximate Cooking Time
	Temperature	Shelf Position	Temperature	
FISH				
	190°C	3	180°C	Fillets 15-20mins.
	190°C	3	180°C	Whole 10mins.per 500g + 10mins.
	190°C	3	180°C	Steaks according to thickness.
ROAST MEATS				
Beef with bone	160°C	2-3	150°C	20-25mins. per 500g + 20-25mins.
	200°C	2-3	190°C	15-20mins. per 500g + 15-20mins.
Beef without bone	160°C	2-3	150°C	30-35mins. per 500g + 30-35mins.
	200°C	2-3	190°C	20-25mins. per 500g + 20-25mins.
Lamb	160°C	2-3	170°C	30-35mins. per 500g + 30-35mins.
	200°C	2-3	190°C	25-35mins. per 500g + 25-30mins.
Pork	160°C	2-3	150°C	35-40mins. per 500g + 35-40mins.
	200°C	2-3	190°C	25-30mins. per 500g + 25-30mins.
Stuffed and rolled - Add approx. 10 mins. per 500g to above cooking times or cook at 200°C for 20mins. then 160°C for remainder.				
THOROUGHLY THAW FROZEN JOINTS AND POULTRY BEFORE COOKING.				
POULTRY				
Chicken	160°C	2-3	150°C	20-25mins. per 500g + 20-25mins.
	200°C	2-3	190°C	15-20mins. per 500g + 15-20mins.
Turkey	160°C	2	150°C	20-25mins. per 500g + 20-25mins.
	200°C	2	190°C	15-20mins. per 500g + 15-20mins.
Stuffed Poultry - Cook at 200°C or at 200°C for 20mins. then 160°C for remainder. Prepacked (fresh or frozen) follow packers cooking times				
CASSEROLE	140-150°C	2-3	140°C	2-4hrs according to recipe
YORKSHIRE PUDDING	220°C	4	200°C	Large tin 30-35mins. Individual 10-20mins.
CAKES				
Very Rich Fruit	140°C	2	140°C	45-50mins. per 500g mixture
Rich fruit (180mm)	150°C	2	145°C	2½-3hrs.
Madeira (180mm)	160°C	2	150°C	80-90mins.
Queen Cakes	180°C	2 & 4 or 3	170°C	15-25mins.
Scones	200°C	2 & 4 or 3	190°C	10-15mins.
Victoria Sandwich	180°C	2 & 4 or 3	170°C	20-30mins.
PASTRIES				
Plate Tart	200°C	2 & 4	190°C	45-50mins. Interchange after 25mins.
Fruit Pie	200°C	2 & 4	190°C	35-40mins.
Tartlets	200°C	4	190°C	15-20mins. according to size.
Puff Pastry	220°C	2, 3 or 4	200°C	20-40mins. according to size.
BREAD	220°C	2 & 4	200°C	20-30mins.
MERINGUES	110°C	3	100°C	2-2½hrs
PUDDINGS				
Baked Egg Custard	160°C	3	150°C	45mins.-1hr.
Baked sponge pudding	190°C	3	180°C	40-45mins.
Milk pudding	140-150°C	3	150°C	2-3hrs.

Cleaning your cooker

Essential information

Before thorough cleaning isolate the electricity supply. Remember to switch on the electricity supply before use.

Never use paint solvents, washing soda, caustic cleaners, biological powders, bleach, chlorine based bleach cleaners, coarse abrasives or salt. Don't mix different cleaning products - they may react together with hazardous results.

Recommended cleaning materials are shown in the table at the end of this section.

If you want to move your cooker for cleaning, see the section called 'Moving your cooker'.

All parts of the cooker can be cleaned with hot soapy water - **but take care that no surplus water seeps into the appliance.**

For cleaning materials see the 'Cleaning Table' at the end of this section.

Hob

It's very easy to clean the Hob with a recommended cleaner.

CAUTION — Do not use abrasive cleaners or pads, oven aerosols or pads or stain removers on the surface.

Daily care

First of all, be sure that all heat indicator lights are off and the cooking surface is cool. Apply a small dab, about the size of a 10p piece, of ceramic cooking cleaning cream in the centre of each area to be cleaned. Dampen a clean paper towel and work the cleaning cream on the cooking surface as if you were cleaning a window. As a final step, wipe the cooking surface with a clean, dry paper towel.

Cleaning for spills

For spills and boil-overs that occur while cooking, turn the unit off and wipe the area surrounding the hot zone with a clean paper towel. If a spill (other than a sugary substance) is on the hot zone, do not clean until the unit is completely cooled down and follow the instructions below ("Cleaning for burned-on spills"). If you accidentally melt anything on the cooking or if you spill foods with a high sugar content (preserves, tomato sauce, etc.), REMOVE the spill IMMEDIATELY with a razor scraper, while the unit is still hot. IMPORTANT: Use an oven glove to protect your hand from potential burns. Scrape the major spill or melted material from the cooking zone and push into a cold area. Then, turn the unit "OFF" and allow to cool before cleaning further. After the cooking surface cools down and the heat indicator lights go off, use the daily care procedure as outlined above.

Cleaning for burned-on spills

Be sure that the heat indicator lights are off and the hob is cool. Remove excess burned-on substance with a single-edged razor scraper. Hold the scraper at approximately a 30° angle to the surface and scrape off the burned-on matter as you would scrape paint off of a window.

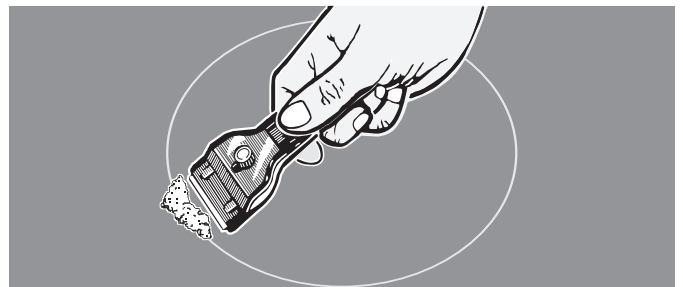

IMPORTANT: Take care when using a sharp scraper.

When you have removed as much as possible with the scraper clean using the daily care procedure as described above.

To remove metal rub-off

Sliding pans on the hob - especially aluminium or copper pans can leave marks on the surface. These marks often appear like scratches, but can be easily removed using the procedure described above for cleaning spills. If the rub-off marks are especially stubborn, use the cleaning cream together with the razor scraper, using the technique described above.

Glide-out™ Grill

Before you remove any of the grill parts for cleaning make sure that they are cool.

The grill pan and grid should be washed in hot soapy water. After grilling meats or any foods that soil, leave to soak for a few minutes in the sink immediately after use. Stubborn particles may be removed from the grid by using a nylon brush. Alternatively the grill pan can be washed in a dish washer.

To remove the grill pan support frame, pull the grill pan forward.

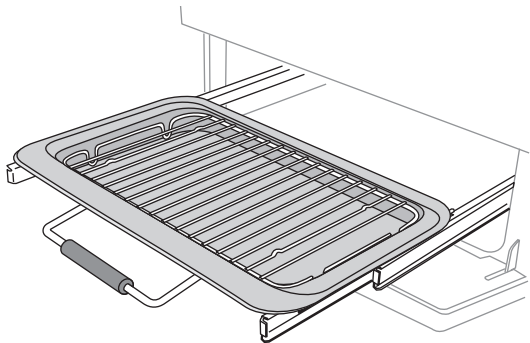

Lift the grill pan clear of the support frame.

The support frame is held to the side rails by two clips on each side.

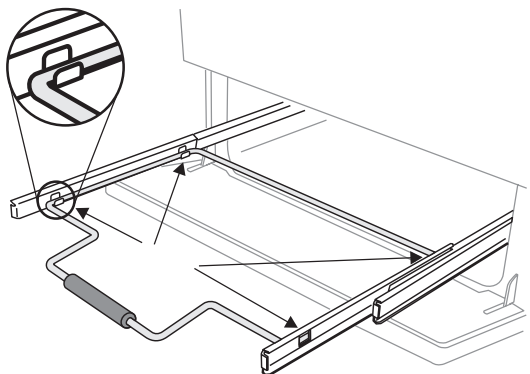

For each side, support the side rail with one hand and with the other hand lift the frame up and out of the side clips.

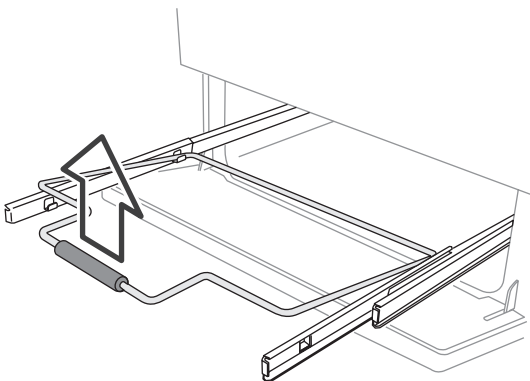

For safety, push the side rails back into the grill chamber.

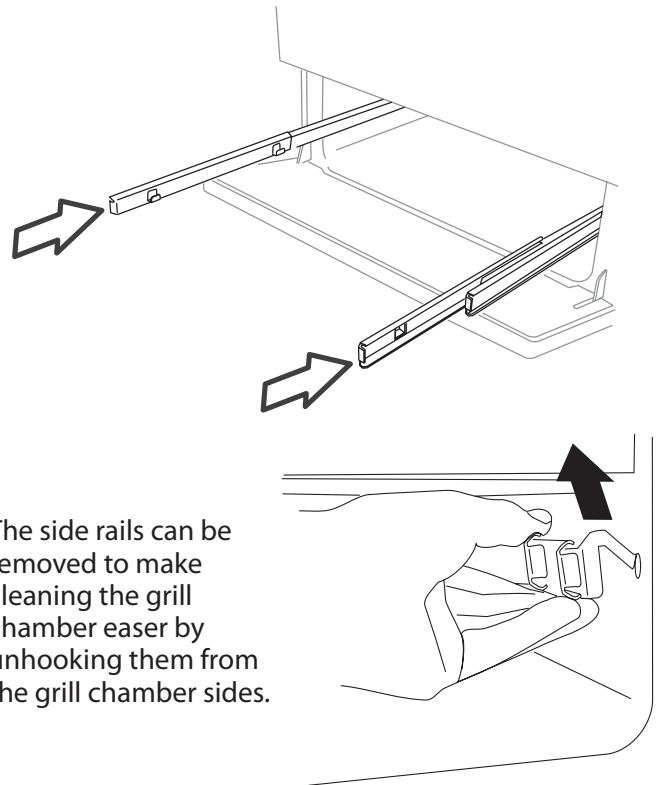

The side rails can be removed to make cleaning the grill chamber easier by unhooking them from the grill chamber sides.

Slides can be wiped clean with soft cloth and mild detergent.

Do not use any abrasive substance.

DO NOT put the side runners in a dishwasher

When you have finished, hook the side rails back onto the sides of the chamber. To refit the frame pull the side rails forward and for each side in turn support the side rail and press the frame down into the side rails. Replace the grill pan.

Control Panel and Doors

Avoid using any abrasive cleaners including cream cleaners, e.g. Cif, on brushed Stainless Steel surfaces. For best results use a liquid detergent e.g. Domestos Multi Surface Cleaner.

The control panel and control knobs should only be cleaned with a soft cloth wrung out in clean hot soapy water. Wipe with a clean dampened cloth then polish with a dry cloth. The oven doors should only be cleaned with a soft cloth wrung out in clean hot soapy water.

The Main Oven

The Main oven has panels which have been coated with a special enamel that partly cleans itself. This does not stop all marks on the lining, but helps to reduce the amount of manual cleaning needed.

The Cook & Clean panels work better above 200°C. If you do most of your cooking below this temperature, occasionally remove the panels and wipe with a lint free cloth and hot soapy water. The panels should then be dried and replaced and the oven heated at 200°C for about one hour. This will ensure the Cook & Clean panels are working effectively.

Don't use steel wool (Brillo) or any other materials that will scratch the surface. Don't use oven cleaning pads.

Removing the Oven Linings

Some of the lining panels can be removed for cleaning and for cleaning behind. Remove the shelves first.

The side panels of either oven can be removed.

Each side of the oven is fixed with four fixing screws. You don't have to remove the screws to remove the oven linings. Lift each side panel upwards and they will slide off the screws. Then pull them forwards.

Once the linings are removed, the oven enamel interior can be cleaned.

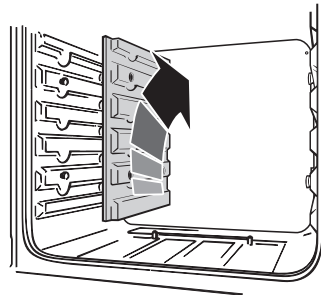

The Tall Oven

To clean the oven sides slide out the shelves, unhook the supports from the oven sides and lift out.

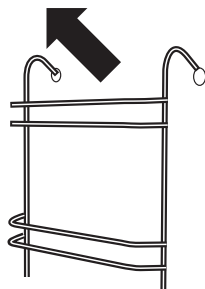

Moving your cooker

Switch off the electricity supply.

The cooker is heavy, two people may be required to move it. There are two levelling rollers at the back and also two screw down levelling feet at the front.

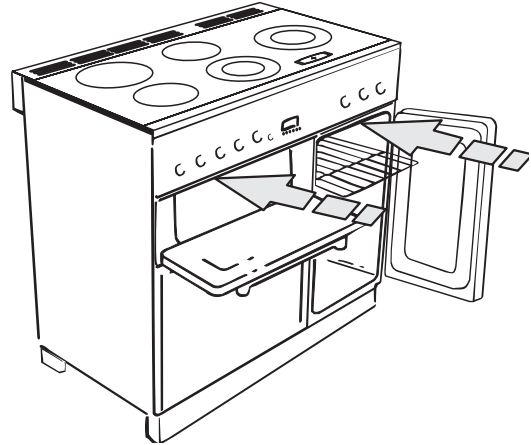

Open the grill door and right hand oven door so that you can get a good grip on the bottom of the fascia panel as you move the oven.

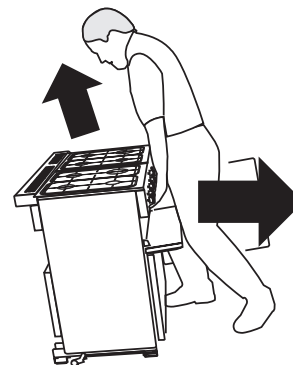

Lift the front of the cooker slightly and pull forward.

Do not move the oven by pulling the door handles or knobs.

Move the oven a bit at a time, checking behind it to make sure the electricity supply cable is not caught. Make sure the cable has sufficient slack to move the cooker forward as you go along.

If a stability chain is fitted, release it as you ease the cooker out. Don't forget to refit it when you replace the cooker.

When you replace the cooker, again check behind to make sure that the electricity cable is not caught or trapped.

Cleaning Table

Hobplate

Part	Finish	Recommended Cleaning Method
Ceramic Hob	Glass with anodised aluminium surround.	Remove any dried baked on food deposits with a ceramic hob scraper from the glass, available from electrical retailers i.e. Curry's. Clean with HobBrite <i>Homecare Products</i> or Easy-Do Hobcare Ceramic and Halogen Hob Cleaner and Conditioner <i>Easy-Do Products Ltd</i> (Curry's) and polish with a soft cloth. Do not use cleaners intended for the ceramic hob on the hob surround. Only use hot soapy water and a soft cloth on the surround.

Outside of cooker

Part	Finish	Recommended Cleaning Method
Door & Door surround.	Enamel or paint	Hot soapy water, soft cloth. Any stubborn stains, remove gently with a liquid detergent.
	Stainless Steel	E Cloth (Comet) or Vileda Microfibre Plus All Purpose Cloth <i>Freudenberg Household Products LP</i> (supermarket)
Sides and Plinth	Painted surface	Hot soapy water, soft cloth.
Splashback/Rear Grille	Enamel or Stainless Steel	Hot soapy water, soft cloth. Cream cleaner, with care, if necessary.
Control panel	Paint, Enamel or Stainless Steel	Warm soapy water. Do not use abrasive cleaners on lettering.
Control Knobs/Handles	Plastic/ Chrome	Warm soapy water, soft cloth.
Oven Door Glass/Glass Lid	Toughened glass	Hot soapy water, cream cleaner/scourer if necessary.

Oven and Grill

Part	Finish	Recommended Cleaning Method
Sides, floor & roof of oven - NOT COOK & CLEAN OVEN PANELS (see below)	Enamel	Any proprietary oven cleaner that is suitable for enamel. CAUTION: CORROSIVE/CAUSTIC OVEN CLEANERS - FOLLOW MANUFACTURERS INSTRUCTIONS. Do not allow contact with the oven elements.
Cook & Clean Oven Panels (some models only)	Special enamel that partly cleans itself	This surface cleans itself at 200°C and above, or the panels can be removed and washed with hot soapy water and a nylon brush. (see 'The Ovens' in 'Cleaning your cooker')
Oven Shelves, Handyrack, Grill Trivet.	Chrome	An oven interior cleaner that is suitable for chrome. Soap filled pad. Dishwasher.
Grill Pan/Meat Tin (some models only)	Enamel	Hot soapy water. Soap filled pad (Brillo). Dishwasher.

Cleaners listed are available from Supermarkets or electrical retailers as stated. Cleaner manufacturer in Italics

For enameled surfaces use a cleaner that is approved for use on vitreous enamel. The vitreous enamel association has a list of approved cleaners. Contact them via their website www.ive.org.uk or telephone: 01527 893031.

Regular cleaning is recommended. For easier cleaning, wipe up any spillages immediately.

To help keep your oven clean, cover meat when roasting, with foil or use a roasting bag. Brush vegetables with fat before placing around the meat.

Troubleshooting

A crack has appeared in the Hob surface

Disconnect the cooker immediately from the power supply and arrange for its repair. Don't use the cooker until after the repair. See the Customer care leaflet for how to contact a service person.

My Hob is scratched

Have you used the correct cleaning methods?

Pots and pans with rough bottoms, or coarse particles (salt or sand) between the pan and the surface of the hob may cause scratches.

Use the recommended cleaning methods. Make sure pan bottoms are smooth and clean. Tiny scratches are not removable but will become less visible in time as a result of cleaning.

Only scratches in the hob surface reported within 14 days of cooker installation are covered by the guarantee. Scratches caused by usage are not covered.

Metal markings on the Hob

Do not slide aluminium or copper pans across the surface. Marks from aluminium and copper pans as well as mineral deposits from water or food can be removed with the cleaning cream.

Steam is coming from the oven

During cooking, food naturally produces steam, particularly when cooking foods with high water content (e.g. oven chips). There may be some steam visible at the grille at the rear of the hotplate. This is perfectly normal. Steam can condense to water droplets on the cool outer trim or the oven door. It may be necessary during cooking to wipe away any moisture with a soft cloth. This will also help to prevent soiling and discolouration of the oven exterior by cooking vapours.

Take care when opening the oven door, as there may be a momentary puff of steam when the oven door is opened. Stand well back and allow any steam to disperse.

The oven fan is noisy

The note of the oven fan may change as the oven heats up - this is perfectly normal.

What cleaning materials are recommended for the cooker?

See the 'Cleaning your cooker' section of these instructions for a full list of recommended cleaning materials. We do not recommend Mr. Muscle, as it contains chemicals which may damage the surfaces of your cooker.

The knobs get hot when I use the oven or the grill, can I avoid this?

Yes, this is caused by heat rising from the oven or the grill, and heating them up.

Don't leave the oven door open.

When grilling make sure that the grill door is open with the grill pan pushed right back to the 'backstop'.

If there is an installation problem and I don't get my original installer to come back to fix it who pays?

You do. Service organisations will charge for their call outs if they are correcting work carried out by your original installer. It's in your interest to track down your original installer.

Current Operated Earth Leakage Breakers

Where the cooker installation is protected by a 30 milliamp sensitivity residual current device (RCD), the combined use of your cooker and other domestic appliances may occasionally cause nuisance tripping. In these instances the cooker circuit may need to be protected by fitting 100mA device. This work should be carried out by a qualified electrician.

Food is cooking too slowly, too quickly, or burning

Cooking times may differ from your previous oven. Check that you are using the recommended temperatures and shelf positions. See the 'Oven cooking guide' section of these instructions. The oven control settings and cooking times are intended to be used only as a guide. Individual tastes may require the temperature to be altered either way, to get the results you want. Try cooking at different temperature setting.

The oven is not cooking evenly

Do not use a tin or baking tray larger than 340mm x 340mm in the Main oven or 232mm x 321mm in the Tall oven.

If you are cooking a large item, be prepared to turn it round during cooking.

If two shelves are used, check that space has been left for the heat to circulate. When a baking tray is put into the oven, make sure it is placed centrally on the shelf.

Check that the door seal is not damaged and that the door catch is adjusted so that the door is held firmly against the seal.

A dish of water when placed on the shelf should be the same depth all over. (For example, if it is deeper at the back, then the back of the cooker should be raised up or the front lowered). If the cooker is not level arrange for your supplier to level it for you.

Oven not coming on when turned on manually

Is the power on? Is the clock illuminated?

Is the key symbol (Ⓚ) showing in the display? See the Clock section of the instructions for more information on the key lock feature of the clock.

If using the Multi-function oven have you set a cooking function?

If not there may be something wrong with the power supply. Is the cooker supply on at the isolator switch?

Oven not coming on when automatic cooking

Timer set correctly but oven knob left OFF by mistake?

Is the key symbol (Ⓚ) showing in the display? See the Clock section of the instructions for more information on the key lock feature of the clock.

If using the Multi-function oven have you set a cooking function?

Oven temperature getting hotter as the cooker gets older

If turning the knob down has not worked or only worked for a short time then you may need a new thermostat. This should be fitted by a service person.

Grill not cooking properly

Are you using the pan and trivet supplied with the cooker? Is the pan being used on the runners, not the floor of the compartment? Is the grill pan pushed fully back to stop?

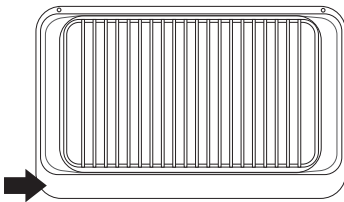

When you pull the grill pan forward is the wide rim at the front? It's important that the wider part is at the front.

The oven light is not working

The bulb has probably blown. You can buy a replacement bulb (which is not covered under the guarantee) from a good electrical shop. Ask for an Edison screw fitting 15w 240v lamp, FOR OVENS. It must be a special bulb, heat resistant to 300 °C. See the 'Customer Care' leaflet for spares by mail order.

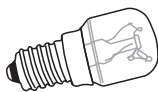

Turn off the power supply.

Make sure the oven is cool. Open the oven door and remove the oven shelves.

Unscrew the bulb cover by turning anticlockwise. It may be very stiff.

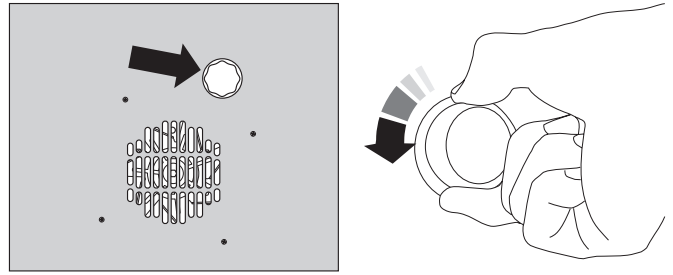

Taking care to protect your fingers in case the bulb should shatter, unscrew the old bulb.

Screw in the new bulb, screw back the bulb cover. Turn on the electricity supply and check that the bulb now lights.

General Safety Instructions

The cooker must be installed by a qualified electrician in accordance with the installation instructions. It should be serviced by a qualified service engineer and only approved spare parts used. Have the installer show you the location of the cooker control switch. Mark it for easy reference. Always allow the cooker to cool and then switch off at the mains and before cleaning or carrying out any maintenance work, unless specified otherwise in this guide.

All parts of the cooker become hot with use and will retain heat even after you have stopped cooking.

Take care when touching the hob especially the marked cooking areas. The glass surface of the hob will retain heat after the controls have been turned off. To minimize the possibility of burns, always be certain that the hob controls are in the OFF position and that the entire glass surface is cool before attempting to clean the hob.

Use dry oven gloves when applicable - using damp gloves might result in steam burns when you touch a hot surface. Never operate the cooker with wet hands.

Do not use a towel or other bulky cloth in place of a glove. They might catch fire if they touch a hot surface.

Always turn the surface unit controls off before removing the pans.

Don't place utensils on the hob surface when it is in use. They may become hot and could cause burns.

Clean the hob with caution. If a wet sponge or cloth is used to wipe spills on a hot surface unit, be careful to avoid steam burns. Some cleansers can produce noxious fumes if applied to a hot surface.

Do not use unstable saucepans and position the handles away from the edge of the hotplate.

Babies, toddlers and young children should not be allowed near the cooker at any time. They should never be allowed to sit or stand on any part of the appliance. Teach them not to play with controls or any other part of the cooker.

Never store anything of interest to children in cabinets above a cooker - children climbing on the cooker to reach them could be seriously injured.

Clean only parts listed in this guide.

In the interests of hygiene and safety the cooker should be kept clean at all times as a build up in fats and other food stuff could result in a fire.

We recommend that you avoid wiping any surface unit areas until they have cooled and the indicator light has gone off. Sugar spills are the exception to this. Please see 'Cleaning your cooker'. When the hob is cool, use only the recommended cleaning cream to clean the hob.

To avoid possible damage to the cooking surface, do not apply the cleaning cream to the glass surface when it is hot. Read and follow all instructions and warnings on the cleaning cream labels. After cleaning, use a dry cloth or paper towel to remove any cleaning cream residue.

Avoid heating an empty pan. Doing so may damage the hob and the pan.

Always keep combustible wall coverings or curtains etc. a safe distance away from your cooker.

Do not place or store items on top of the glass hob surface when it is not in use.

Do not spray aerosols in the vicinity of the cooker while it is in on.

Do not store or use combustible materials, or flammable liquids in the vicinity of this appliance.

Do not use water on grease fires. Never pick up a flaming pan. Turn the controls off. Smother a flaming pan on a surface unit by covering the pan completely with a well fitting lid or baking tray. If available use a multipurpose dry chemical or foam-type fire extinguisher.

Never leave the hob unattended at high heat settings. Pans boiling over can cause smoking and greasy spills may catch on fire.

Never wear loose-fitting or hanging clothes while using the appliance. Be careful when reaching for items stored in cabinets over the hob. Flammable material could be ignited if brought in contact with a hot surface unit and may cause severe burns.

Take great care when heating fats and oils, as they will ignite if they get too hot.

Use a deep fat thermometer whenever possible to prevent overheating fat beyond the smoking point.

Never leave a chip pan unattended. Always heat fat slowly, and watch as it heats. Deep fry pans should be only one third full of fat. Filling the pan too full of fat can cause spill over when food is added. If you use a combination of oils or fats in

frying, stir them together before heating, or as the fats melt.

Foods for frying should be as dry as possible. Frost on frozen foods or moisture on fresh foods can cause hot fat to bubble up and over the sides of the pan. Carefully watch for spills or overheating of foods when frying at high or medium high temperatures. Never try to move a pan of hot fat, especially a deep fat fryer. Wait until the fat is cool.

When the grill is on, do not use the top of the flue (the slot along the back of the cooker) for warming plates, dishes, drying tea towels or softening butter.

When using an electrical appliance near the hob, be sure that the cord of the appliance does not come into contact with the surface area.

If you find a crack in the hob surface immediately disconnect the appliance from the supply and arrange for its repair.

Take care that no water seeps into the appliance

Only certain types of glass, glass-ceramic, earthenware or other glazed containers are suitable for hob cooking; others may break because of the sudden change in temperature.

Use proper pan size-select pans having flat bottoms large enough to cover the surface unit's heating area. The use of undersized pans will expose a portion of the surface unit to direct contact and may result in ignition of clothing. Proper relationship of pans to surface unit will also improve efficiency.

Do not allow anyone to climb, stand or hang on any part of the cooker.

Do not use aluminium foil to cover shelves, linings or the oven roof.

Make sure that your kitchen is well ventilated at all times. Use extractor fans or hoods when fitted.

Never heat unopened food containers. Pressure build up may make container burst and cause injury.

The cooker is designed for cooking foods only and must not be used for any other purpose.

The oven should NOT be used for heating the kitchen, not only does this waste fuel but the control knobs may become overheated.

When the oven is on DO NOT leave the oven door open for longer than necessary.

The specification of this cooker should not be altered.

This appliance is heavy, take care when moving it.

When the cooker is not in use ensure that the control knobs are in the off position.

Do not slide pans across the hob because this can scratch the glass - the glass is scratch resistant, not scratch proof. Sharp instruments, rings or other jewellery and rivets on clothing could scratch the hob surface.

Do not use the surface as a cutting board.

Don't store heavy items above the hob. If they drop on the hob, they could cause damage.

Installation

Dear Installer

Before you start your installation, please complete the details BELOW.

If your customer has a problem relating to your installation they will be able to contact you easily.

Thank you

Installer's Name

Installer's Company

Installer's Telephone number

Regulations

This appliance must be installed by a qualified electrician to comply with the relevant regulations and also the local electricity supply company requirements.

This appliance is designed for domestic cooking only. Use for any other purpose could invalidate any warranty or liability claim.

You will need the following equipment to complete the cooker installation satisfactorily

- ▶ Multimeter (for electrical checks)

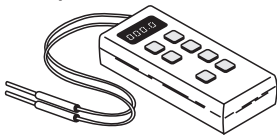

- ▶ Steel tape measure
- ▶ Cross head screwdriver
- ▶ Spirit level
- ▶ Cooker levelling tool (provided in pack)

Checking the parts

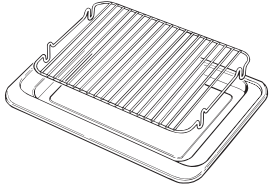
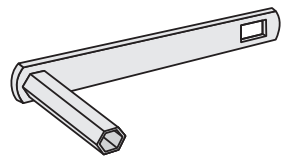
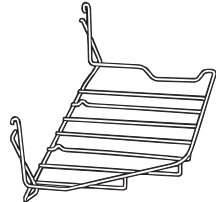
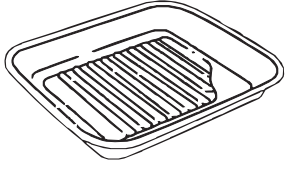
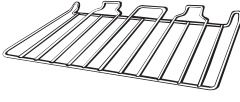
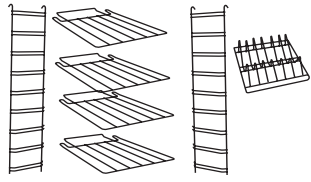
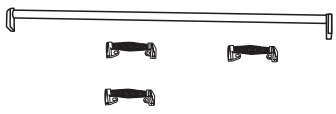
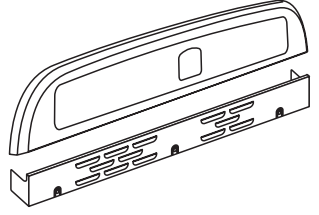
 <p>Grill pan and trivet</p>	 <p>Levelling tool</p>
 <p>Handyrack</p>	 <p>Meat tin</p>
 <p>2 main oven shelves</p>	 <p>Tall oven shelves & shelf supports</p>
 <p>1 large and 3 small handles</p>	 <p>Splash back & Plinth</p>

Positioning the Cooker

The diagrams below show the minimum recommended distance from the cooker to nearby surfaces.

The cooker should not be placed on a base.

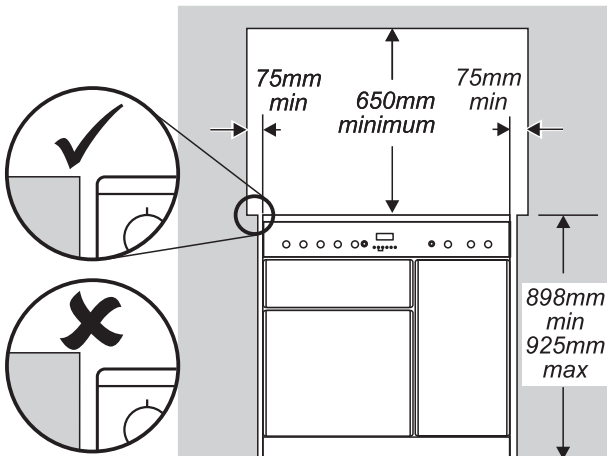

The hot surround should be level with, or above, any adjacent work surface. Above hotplate level a gap of 75mm should be left between each side of the cooker and any adjacent vertical surface.

For non-combustible surfaces (such as unpainted metal or ceramic tiles) this can be reduced to 25mm.

A minimum space of 650mm is required between the top of the hotplate and a horizontal combustible surface.

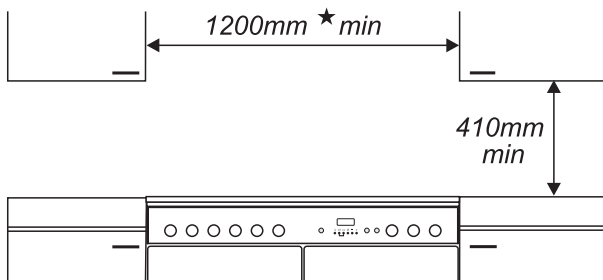

*Any cooker hood should be installed in accordance with the hood manufacturer's instructions.

Surfaces of furniture and walls at the sides and rear of the appliance should be heat, splash and steam resistant. Certain types of vinyl or laminate kitchen furniture are particularly prone to heat damage and discolouration. We cannot accept responsibility for damage caused by normal use of the cooker to any material that de-laminates or discolours at temperatures less than 65°C above room temperature.

For safety reasons curtains must not be fitted immediately behind the cooker.

We recommend a gap of 1110mm between units to allow for moving the cooker. If a flush fit is required, fit the cooker up to the unit at one side then fit the unit the other side. Do not box the cooker in; it must still be possible to move the cooker in and out for cleaning and servicing. The cooker should not be placed on a base.

A clearance of 130mm is required if the cooker is near a corner of the kitchen to allow the oven doors to open.

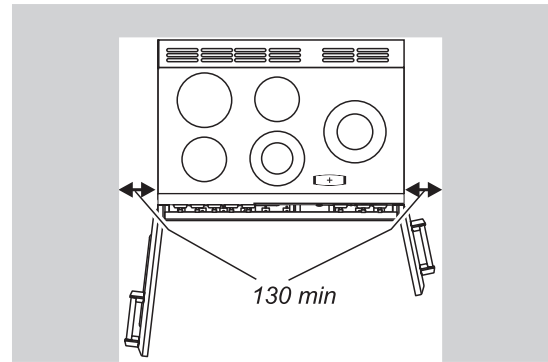

Unpacking the Cooker

Do not take any packaging off the cooker until it is directly in front of the place it is to be installed (unless it will not fit through a door in its outer packaging).

Cut the banding straps and lift the cardboard box off the cooker, leaving the cooker standing on the base packaging. See the loose unpacking sheet.

Moving the Cooker

The cooker is very heavy. Take great care.

We recommend two people manoeuvre the cooker. Ensure that the floor covering is firmly fixed, or removed to prevent it being disturbed when moving the cooker around. You will need the levelling tool.

From the back tilt the cooker forward and remove the rear half of the polystyrene base pack.

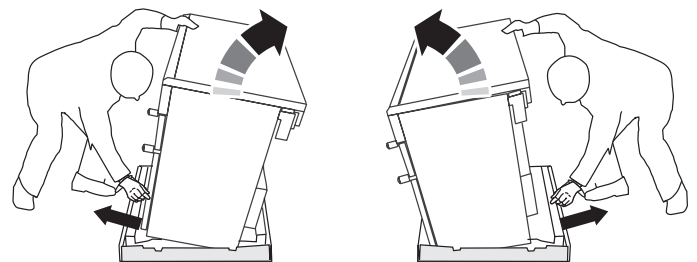

Repeat from the front and remove the front half of the poly base.

LOWER THE TWO REAR ROLLERS.

First fit the levelling tool on the hexagonal adjusting nut as shown below.

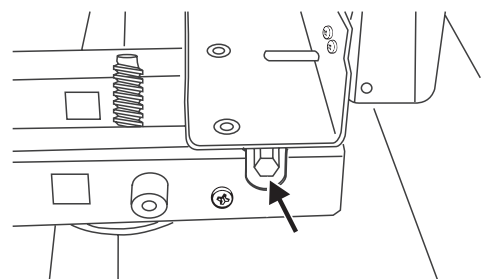

Make 10 complete (360°) turns clockwise. (This means turning and removing the levelling tool 20 times).

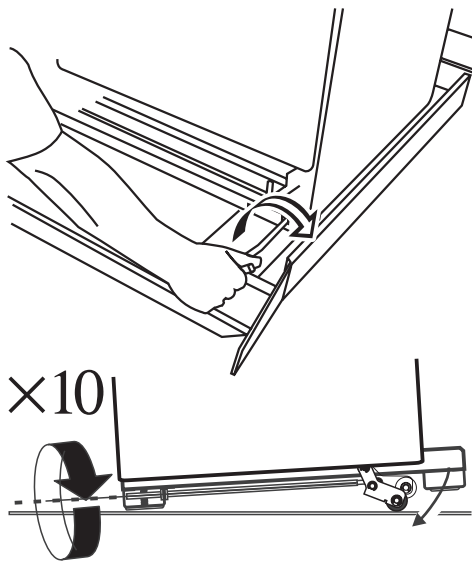

Make sure you lower BOTH REAR ROLLERS. There are two adjusting nuts, one for each roller, at both the front bottom corners of the cooker.

Unfold the rear edge of pack base tray. Open the grill door and the Tall oven door. Grip under the fascia panel and lift the front of the cooker.

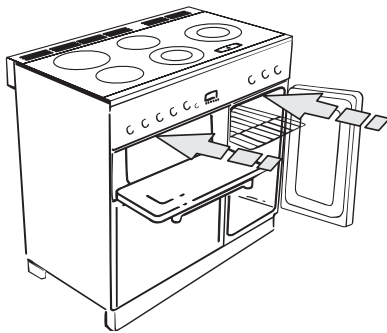

Carefully push the cooker backwards off the pack base. Remove the pack base tray. Position the cooker close to its final position leaving just enough space to get behind it.

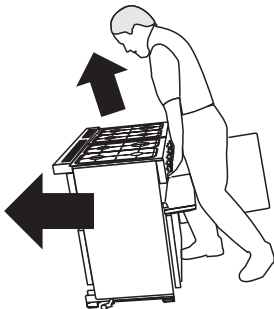

Do not use the door handles or control knobs to manoeuvre the cooker. Use the hotplate and griddle bowl areas.

Levelling

You are recommended to use a spirit level on a shelf in one of the ovens to check for level.

Place the cooker in its intended position taking care not to twist it within the gap between the kitchen units as damage may occur to the cooker or the units.

The front feet and rear rollers can be adjusted to level the cooker. To adjust the height of the rear of the cooker use the levelling tool supplied to turn the adjusting nuts at the front bottom corners of the cooker. To set the front feet turn the bases to raise or lower.

Fit the Handles

Remove the 4mm Allen screws from the doors with the hexagon key tool. Use the screws to fit the door handles.

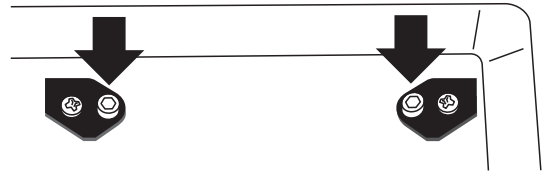

The handles should be above the fixings.

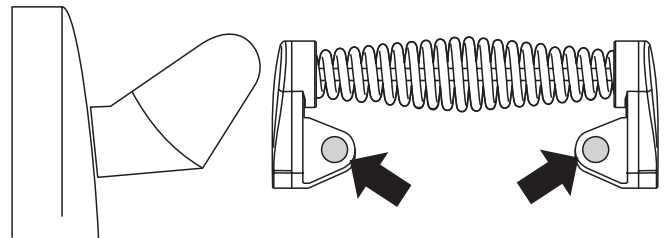

Fit the plastic blanking plugs to the fixing holes.

Remove the 4mm Allen screws from the top corners of the fascia and fix the front handrail in position.

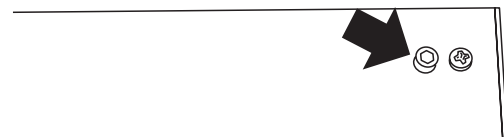

Fitting the splash back

The cooker can be installed with or without the supplied splashback. To fit the splash follow the instructions below.

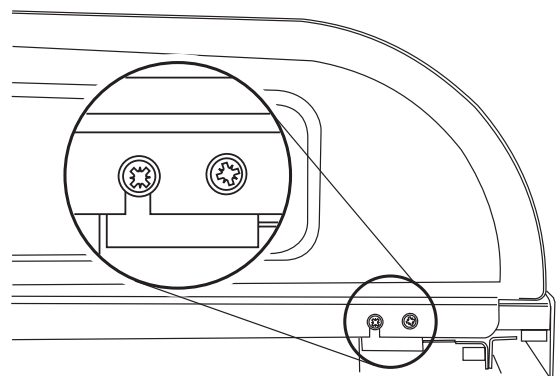

view from the rear of the cooker

The splash back is fitted using 4 screws in the rear edge of the flue grille, two at each end. Remove the outer two screws and loosen the inner pair. Fit the splash over the inner screws and then refit the outer two screws. (see figure).

Electrical Connection

This appliance must be installed by a qualified electrician to comply with the relevant regulations and also the local electricity supply company requirements.

WARNING: THIS APPLIANCE MUST BE EARTHED

Note

The cooker must be connected to the correct electrical supply as stated on the voltage label on the cooker, through a suitable cooker control unit incorporating a double pole switch having a contact separation of at least 3mm in all poles. This cooker must not be connected to an ordinary domestic power point.

The total electrical load of the appliance is approximately 15 kW. The cable size used should be suitable for this load and comply with all local requirements.

Access to the mains terminal is gained by removing the electrical terminal cover box on the back panel.

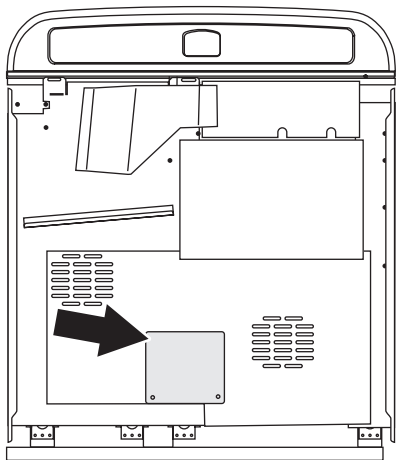

Connect the mains cable to the correct terminals for your electrical supply type. Please note the maximum cable size is 10mm² for the 3-pronged links.

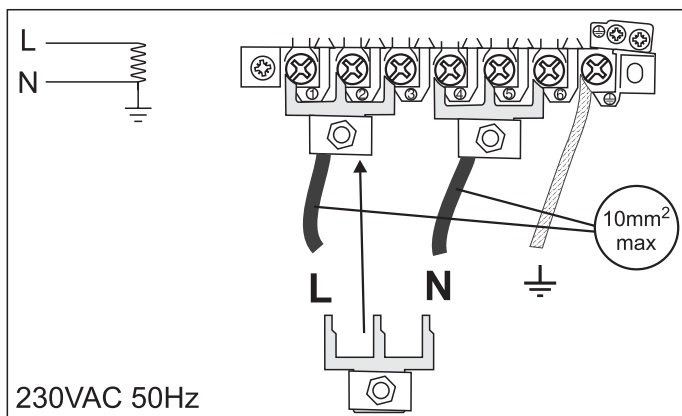

Check that the links are correctly fitted and that the terminal screws are tight.

Secure the mains cable using the cable clamp.

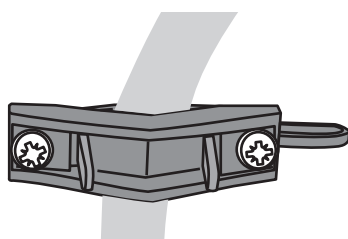

Current Operated Earth Leakage Breakers

Where the installation is protected by a 30 milliamp sensitivity residual current device (RCD), the combined use of your cooker and other domestic appliances may occasionally cause nuisance tripping. In these instances the cooker circuit may need to be protected by fitting 100mA device. This work should be carried out by a qualified electrician.

Fitting the plinth

Loosen the 3 screws along the front bottom edge of the cooker. Hook the central keyhole over the central screw. Twist and fit each end keyhole over their respective screws. Tighten the fixing screws.

Oven Light

Press the oven light switch and check that the light is working.

NB. The oven light bulb is not included in the guarantee.

Hobplate

Turn on each plate in turn and check that it heats up.

Grill

Open the grill compartment door. Turn on the grill control and check that the grill heats up.

Oven check

Set the clock to the time of day

When the clock is first connected the display will flash (0 . 0 0) and (0 0) alternately.

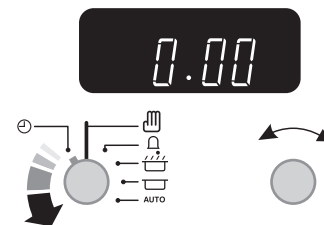

To set the clock to read the time of day turn and hold the Timer knob to the clock symbol ⌚ and at the same time turn the Adjusting knob left or right until the clock shows the time of day. Remember this is a 24 hour clock. Let go of the Timer knob and it will spring back to the vertical oven manual setting.

Turn on the oven and check that the oven fan starts to turn and that the oven starts to heat up. Turn off the oven.

Customer care

Please complete your details in this Guide, inform the user how to operate the cooker and hand over the Instructions.

Thank you.

SERVICING - WARNING

Disconnect from the electricity before servicing. Check appliance is safe when you have finished.

Servicing Notes

Disconnect from electricity supply before commencing servicing, particularly before removing any of the following: control panel, side panels, ceramic hob, or any of the electrical components or cover boxes. Before electrical reconnection check that the appliance is electrically safe.

1. To Remove a Side Panel

Disconnect from electricity supply.

Pull the cooker forward.

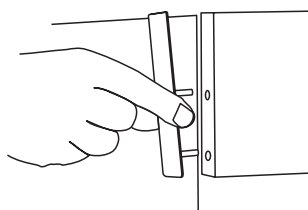

Pull off the push fit control panel end caps at each end and remove the end fixing screws under the end cap.

Remove the retaining screws for each panel (1 at the front and 2 at the rear). The lower front retaining screws (one each side) are situated beneath the lower edge at the front corners of the side panels

Reassemble in reverse order.

2. To Lift up the Ceramic Hob

Pull the cooker forward.

Pull off the push fit control panel end caps at each end and remove the end fixing screws under the end cap.

Remove the lower front retaining screws (one each side) situated beneath the lower edge at the front corners of the side panels.

Swing the side panels to gain access to the hob fixing screws (1 each side) at the top front of the side uprights.

Remove these screws.

Caution

The ceramic hob material is much more sensitive to scratches on the underside than the top.

Lift up the ceramic hob at the front and prop in position with a non-metallic prop.

Take care not to touch or scratch the underside of the ceramic as this will weaken the material and cause the top to shatter.

3. To replace a hob element.

Lift up the ceramic hob see 2. The elements are now accessible.

4 To Remove the Control Panel

Disconnect from electricity supply.

Remove the handrail by removing the 2 end bracket fixing screws.



Pull off the push fit control panel end caps at each end and remove the end fixing screws under the end cap.

Pull off all the control knobs. Open the grill and oven doors and remove the control panel fixing screws underneath the control panel. The screws directly below the clock are for the clock fixing bracket - don't remove them at this stage.

Lift the control panel, pull forward and disconnect the wiring from the rear.

Reassemble in reverse order. When replacing leads refer to the wiring diagram. Check operation of timer.

5. To Remove Oven Light Switch

Remove control panel (see 4).

NB The old switch may be destroyed during removal.

Remove switch button and old switch from its bezel by gripping the switch body behind the control panel and twisting sharply.

The switch bezel can then be removed by folding back its locking wings and pushing forward. Fit the new bezel to the control panel by first lining up the raised key on its body with the cut-out in the control panel and pushing it in from the front. Assemble the new switch to the bezel by lining up the key sections and pushing home. Fit the new button by pushing in from the front.

Replace control panel in reverse order and test for correct operation.

6. To Remove Electronic Timer

Disconnect from electricity supply.

Pull off the timer control buttons and remove the control panel (See 4). Remove the timer/mounting bracket assembly from the control panel by removing the two fixing screws. Remove the timer from its mounting bracket by depressing the plastic lugs on the timer case, at the same time pulling the unit forward.

Reassemble in reverse order. When replacing leads refer to the wiring diagram. Check operation of timer.

SERVICING - WARNING

Disconnect from the electricity before servicing. Check appliance is safe when you have finished.

7. To Remove a Thermostat

Lift up the ceramic hob top (see 2). Remove control panel (see 4). Open appropriate oven door and remove oven furniture.

Right hand oven

Remove thermostat phial cover (2 screws). Unclip the thermostat phial from the clips in the oven back.

Left hand oven

Pull cooker forward to gain access to the cover box at the rear of the cooker. Remove the screws securing the cover and lift clear.

Feed the thermostat capillary out of the oven. Disconnect wiring from thermostat. Remove 2 screws holding thermostat to mounting panel. Fit new thermostat and reassemble in reverse order. Ensure that the phial is clipped to the oven back with the phial centrally positioned between the clips.

Check operation of thermostat.

8. To Change Grill Controller

Lift up the ceramic hob top (see 2). Remove control panel (see 4). Disconnect wiring from controller. Remove 2 screws holding controller to mounting panel. Fit new controller and reassemble in reverse order. Check for correct operation.

9. To Remove Grill Outer Door Panel

Open left hand oven door and remove 2 screws from bottom edge of grill door. Open grill door, support grill door outer panel and remove two screws from top inner face of grill door.

Reassemble in reverse order.

10. To Remove an Oven Door

Open oven door and remove Handyrack (where fitted) by springing one side out of the bracket on the door and sliding the other side free.

Door is heavy - take care. Open the oven door. Loosen the two top hinge screws.

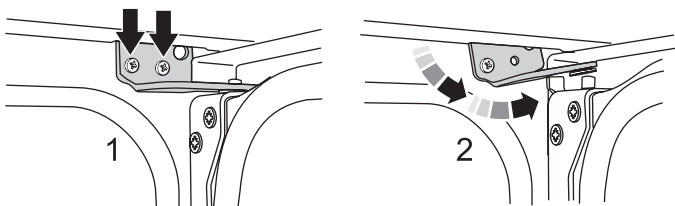

Support the weight of the door and remove the screw nearest the hinge pin. Swing the hinge up and away from the hinge pin on the door.

Lift the door away from the bottom hinge.

Re-assemble in reverse order.

When replacing the door ensure that the nylon hinge bush is in position between the hinge pin and the hinge bracket at the both the bottom and top.

11. To Change Oven Door Outer Panel

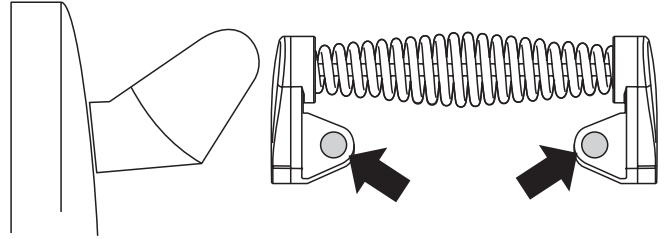

Remove the two plastic blanking plugs from the door handles. Remove the 4mm Hex headed screws holding the handle to the door with the hexagon key tool. Remove two screws from top edge and two from bottom edge of the door.

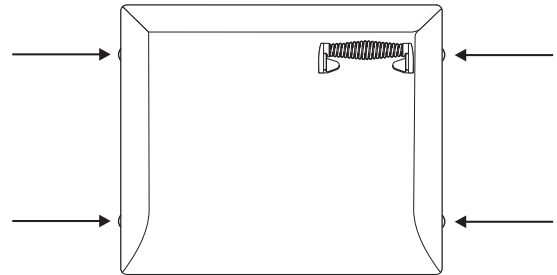

Remove outer door panel. Fit door handle to new panel. Fit the plastic blanking plugs to the fixing holes.

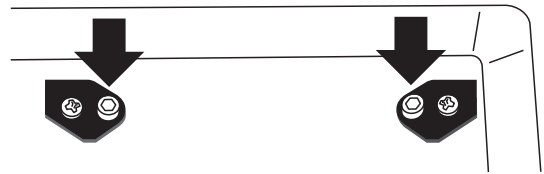

The handles should be above the fixings.

Fit panel to door. If replacing the outer panel on the right hand door (with the Thermodial) take care to make sure the sensor of the Thermodial is sealed to the door by the rubber grommet.

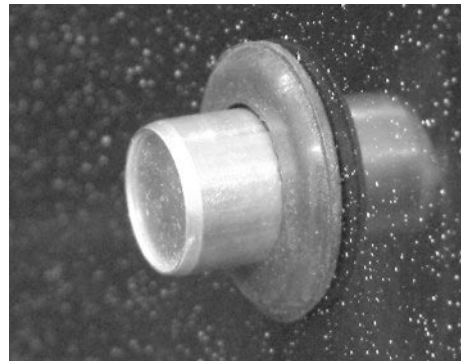

Reassemble in reverse order.

SERVICING - WARNING

Disconnect from the electricity before servicing. Check appliance is safe when you have finished.

12. To Change Main Oven Door Catch

Remove outer door panel (see 15). Remove screws 'B' holding catch assembly to inner door panel. Fit new catch and reassemble in reverse order.

Check correct door operation.

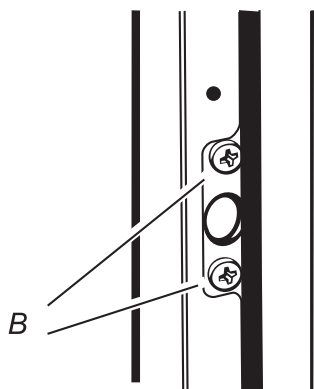

13. To Adjust Main Oven Door Catch Keep

Open oven door, slacken off locknut at base of keep, and screw in or out as required until required fit is obtained.

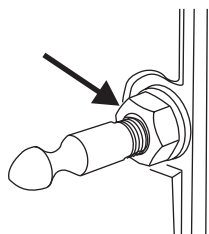

Retighten locking nut.

14. To Change Oven Door Seal

Open oven door. The seal is held in place by small hooks on the rear face. At the corner pull seal diagonally away from the door centre until that hook is released. Proceed to the next hook and release it in a similar way, and so on.

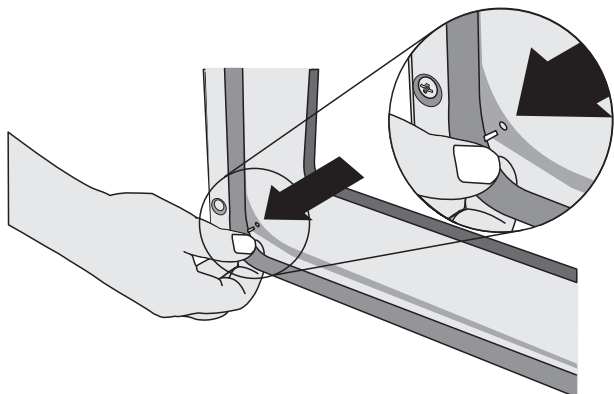

When fitting new seal, position the seal join at the bottom. Hook the new seal in one of the corner holes of the door, and proceed round the door snapping in each hook in turn.

15. To Remove Oven Inner Back.

Open the oven door. Remove oven furniture. For the Left hand oven unscrew the 2 thermostat phial fixing screws.

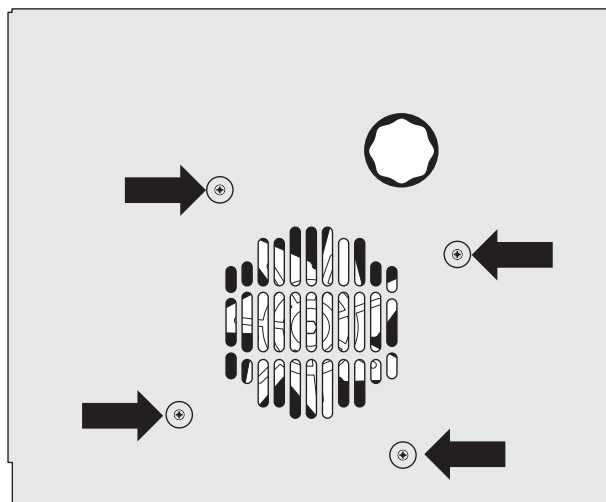

Remove the fixings that secure the inner back to the oven rear.

Lift the removable panel away. Re-assemble in reverse order. Ensure that the retaining fixings are fully tightened. For the Left hand oven unscrew the 2 thermostat phial fixing screws. Remove the screws that secure the inner back to the oven rear. Lift the removable panel away. Re-assemble in reverse order. Ensure that the retaining fixings are fully tightened.

16. To Replace an Oven Fan

Disconnect from electricity supply.

Pull the unit forward to access the cover boxes at the rear of the appliance. Remove the fixings that secure the cover and lift it clear. Remove the fan wiring, noting the connection positions. Remove the inner back as detailed in Section 20. Hold the fan blades and undo the centre nut (Left hand thread), brass washers, fan blade and Circlip. Undo the fixings that retain the fan and remove it from the cavity rear. Fit the replacement and re-assemble parts in reverse order. Check that the oven operates satisfactorily.

17. To Remove an Oven fan Element

Disconnect from electricity supply.

Remove the inner back as detailed in Section 20. Remove the fixings that secure the element within the oven and lift the element away carefully. Disconnect the leads and connect to the replacement element and re-assemble parts in reverse order. Check that the oven operates correctly.

18. To Remove Grill Element.

Disconnect from electricity supply.

Remove grill pan from grill chamber. From inside grill compartment remove enamelled front shield from grill roof, 2 screws and washers. Remove 2 screws and washers securing the grill element front support. Remove 1 screw from each of the grill elements and withdraw grill elements from grill chamber. Disconnect the leads and connect to the replacement elements and re-assemble parts in reverse order. Check operation of grill.

SERVICING - WARNING

Disconnect from the electricity before servicing. Check appliance is safe when you have finished.

19 To Remove the Left hand Oven Bottom and Top Elements

Disconnect from the electricity supply.

Bottom Element

Pull the cooker forward to access the cover boxes at the rear of the unit. Remove the fixings that secure the cover and lift it clear.

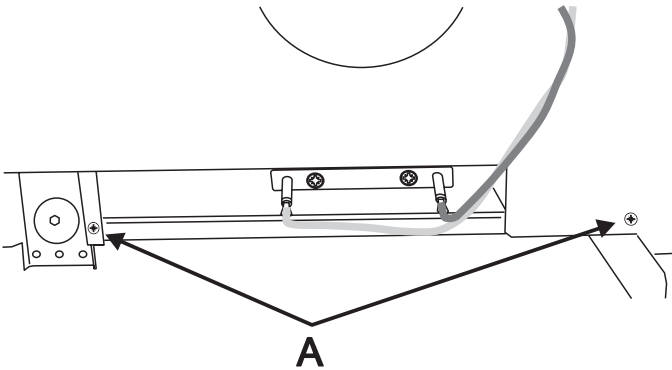

Remove the 2 screws 'A' and allow the plate to drop down.

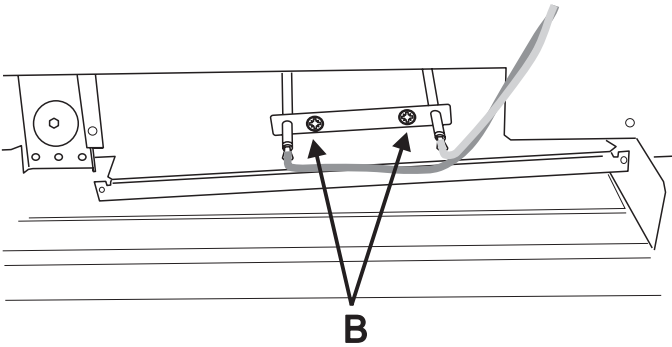

Remove the 2 screws B, holding the element to the bottom sheet.

Disconnect the leads, noting their positions.

Withdraw bottom element. Fit the new element and re-assemble parts in reverse order.

Top Element

Open the Left hand oven door and undo the fixings that secure the heat shield. Remove the top element bracket fixings and withdraw element. Replace the element and re-assemble parts in reverse order. Check that the oven operates satisfactorily.

20. To change oven light bulb.

Disconnect from the electricity supply.

Remove the oven furniture. Unscrew the bulb.

Fit an Edison screw fitting 15w 125-130v lamp, FOR OVENS. It must be a special bulb, heat resistant to 300°C

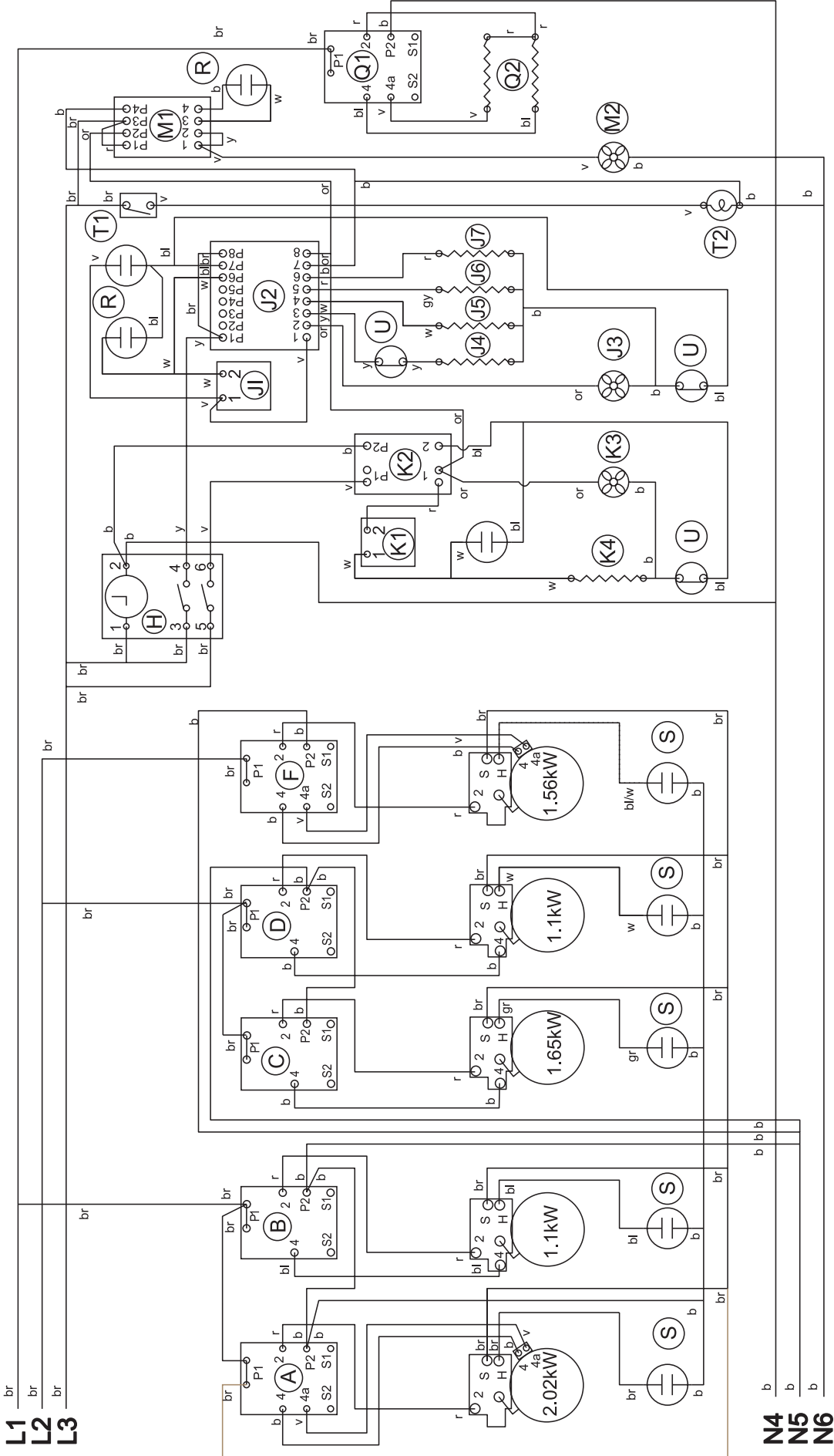

L1
L2
L3

N4
N5
N6

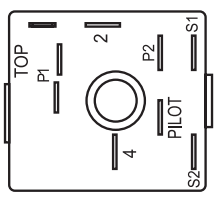

B, C, D

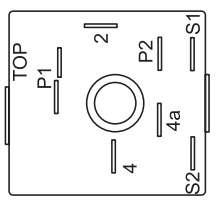

A, F, Q1

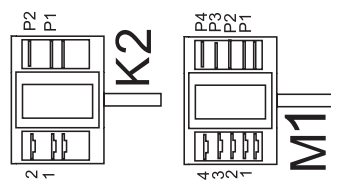

J2

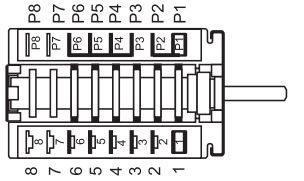

H

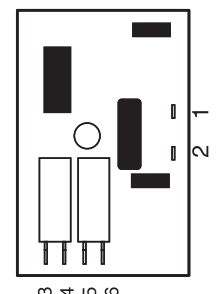

Circuit Diagram

Connection shown in circuit diagram is for single phase. Ratings are for 230V 50Hz

			Colour Code
A	Right hand end dual circuit hob energy regulator	K1	Right hand oven thermostat
B	Right hand rear hob energy regulator	K2	Right hand oven switches
C	Left rear hob energy regulator	K3	Right hand oven fan
D	Left hand front hob energy regulator	K4	Right hand fan oven element
F	Right hand front hob energy regulator	L	Line terminal
H	Clock	M1	Cooling fan switch
J1	Multi function oven thermostat	M2	Cooling fan
J2	Multi function oven function switches	N	Neutral terminal
J3	Multi function oven fan	Q1	Grill energy regulator
J4	Multi function oven fan element	Q2	Grill elements
J5	Multi function oven browning element (inner pair)	R	Facia indicator neons
J6	Multi function oven top element (outer pair)	S	Hob indicator neons
J7	Multi function oven base element	T1	Oven light switch
		T2	Oven light bulb
		U	Cut-out
			b Blue
			bl Black
			br Brown
			gr Green
			gy Gray
			or Orange
			r Red
			v Violet
			w White
			y Yellow

Technical Data

INSTALLER: Please leave these instructions with the User.

DATA BADGE LOCATION : Cooker back, serial number repeater badge below oven door opening.

Dimensions

Overall height	minimum 893mm	maximum 920mm
Overall width	900mm See 'Positioning of Cooker'	
Overall depth	648mm	
Space for fixing	See 'Positioning of Cooker'	
Minimum space above hotplate	650mm	

Connections

Electric	220 - 240V 50Hz
-----------------	-----------------

Hob

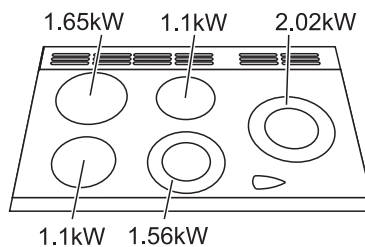

Ovens	Left hand Multifunction Oven	Right hand Fan Oven
Fan element	2.5kW	2.5kW
Top element	1.2kW	
Browning Element	1.15kW	
Bottom element	1.0kW	

Grill	2.3kW
--------------	-------

Maximum total electrical load at 230V 15 kW (approximate total including oven lights, oven fan etc.)

Ovens	Multifunction	Forced air convection
Energy efficiency class : on a scale of A (more efficient) to G (less efficient)	B	B
Energy consumption based on standard load	0.90kWh	0.95kWh
Usable volume (litres)	62	53
Size	Medium	Large
Time to cook standard load	41 minutes	49 minutes
Baking area	1400cm ²	790cm ²

RANGEmaster

Clarence Street, Royal Leamington Spa,
Warwickshire, CV31 2AD, England.

Tel: +44 (0) 1926 457400 Fax: +44 (0) 1926 450526

E-mail: consumers@rangemaster.co.uk

www.rangemaster.co.uk

AGA FOODSERVICE GROUP

