

EPSON Stylus® Photo R300 Series

Start Here



CPD-17016
4044644-00
XXX

1 Unpack

1 Remove everything from the box.

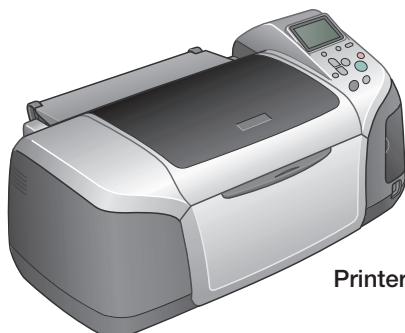

Printer

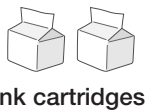

Ink cartridges



Small CD insert



Quick Reference



CD position check paper

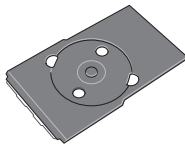

CD/DVD Tray



Preview Monitor
(included with EPSON Stylus Photo R300M only)



Preview Monitor Base
(included with EPSON Stylus Photo R300M only)



Printer Software CD-ROM



User's Guide

2 Remove all the tape and packing material from the printer.

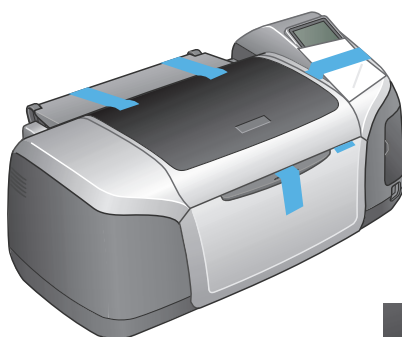

3 Open the output tray and lift the printer cover. Then remove the tape.

Make sure the CD/DVD tray guide is closed completely.

Make sure the tray guide is up

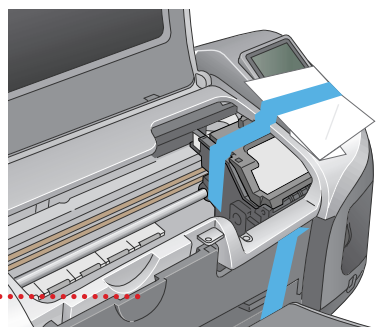

continue

If you have the EPSON Stylus Photo R300M, you need to attach the preview monitor.

- 1 Unscrew the cap from the end of the screw on the base. Then remove the screw.

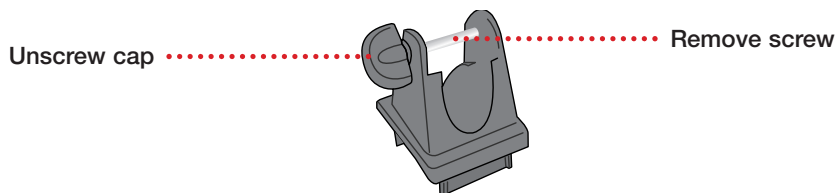

- 2 Position the monitor into the base as shown, lining up the holes for the screw.

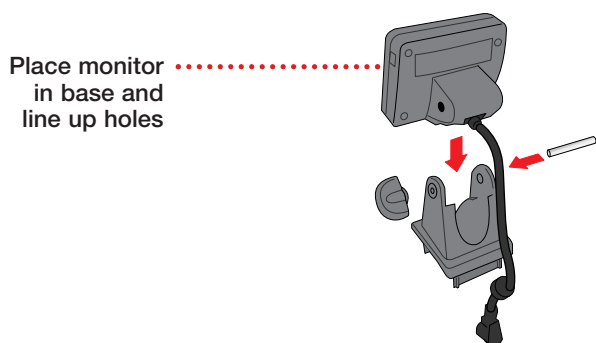

- 3 Push the screw through the holes (it can fit only one way) and screw the cap back onto the end of the screw.

- 4 Remove the plastic cover from the printer.

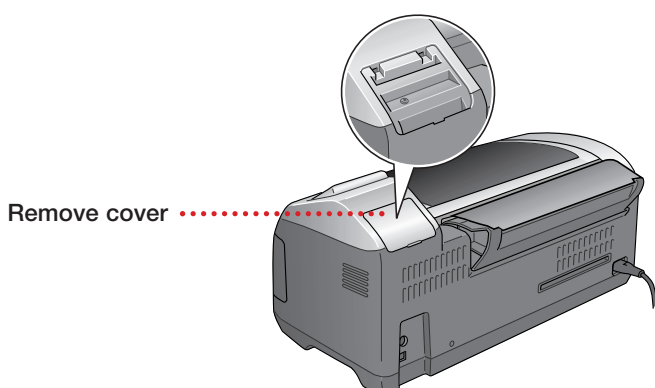

- 5 Insert the tabs on the monitor base into the slots on the printer.

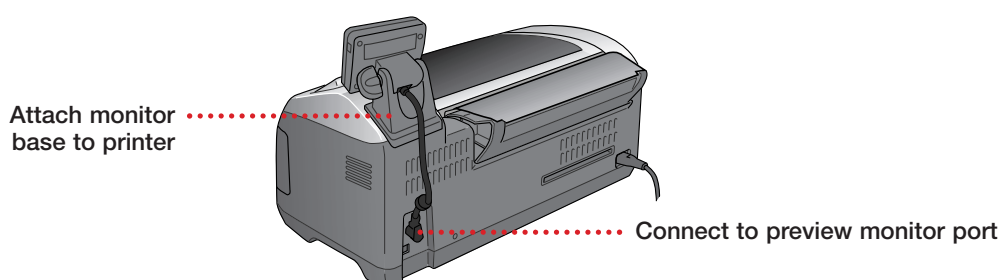

- 6 Remove the cap from the end of the monitor cable, then connect it to the preview monitor port on the back of the printer.

2 Turn On the Printer

- 1 Plug the printer's power cord into a grounded electrical outlet.

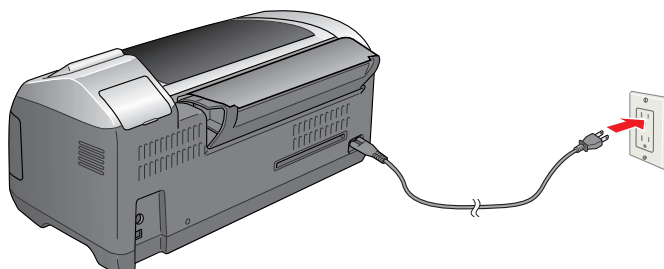

STOP: Do not connect the printer to your computer yet. Wait until you are instructed to connect the USB cable in section 5, "Install Software."

- 2 Press the  power button to turn on the printer.

CAUTION: Never use an external switch, such as a wall switch or power strip switch, to turn the printer on or off.

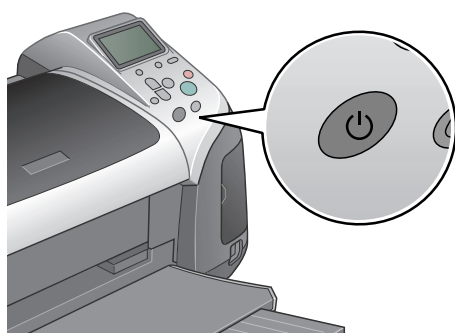

continue

3

Install the Ink Cartridges

- 1** Flip open the paper support and pull up the extension.



- 2** Open the output tray, then pull out the extension.

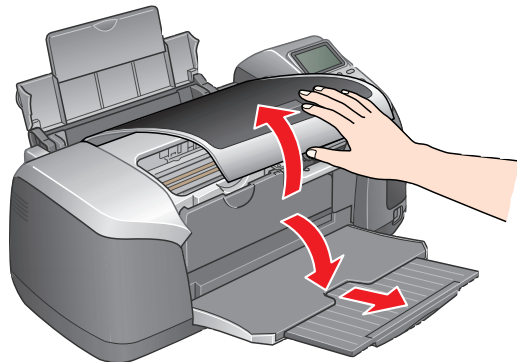

- 3** Lift the printer cover.

- 4** Unwrap the ink cartridges.



Don't touch the green circuit board or remove any labels.

- 5** Open the cartridge cover and remove the paper insert.

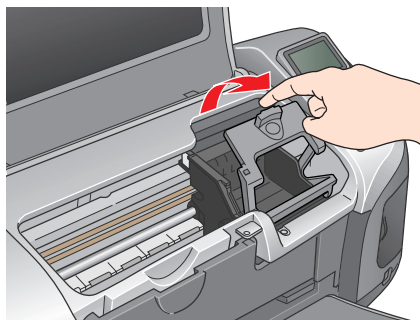

- 6** Lower each cartridge into its holder with the green circuit board facing the front.

The color of the cartridge label should match the marker on the holder.

Then gently push each ink cartridge down until it is firmly seated.

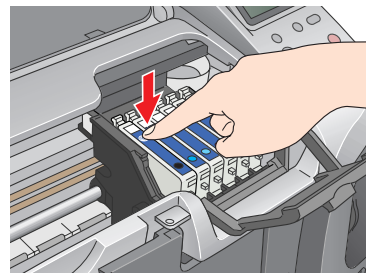

- 7** Close the cartridge cover.

- 8** Press forward on the front left corner of the cartridge cover to lock it in place.

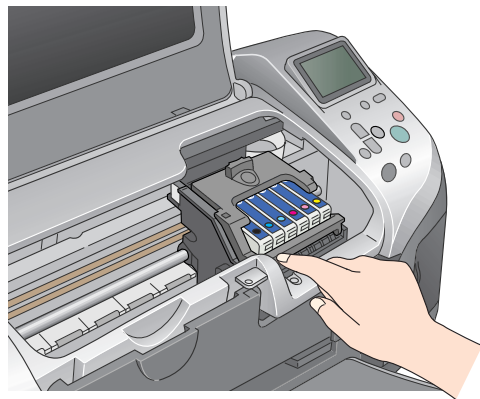

- 9** Press the  Maintenance button and close the printer cover.

CAUTION: Don't turn off the printer or interrupt charging while the light is flashing or you'll waste ink.

A progress bar is displayed on the LCD panel during ink charging.

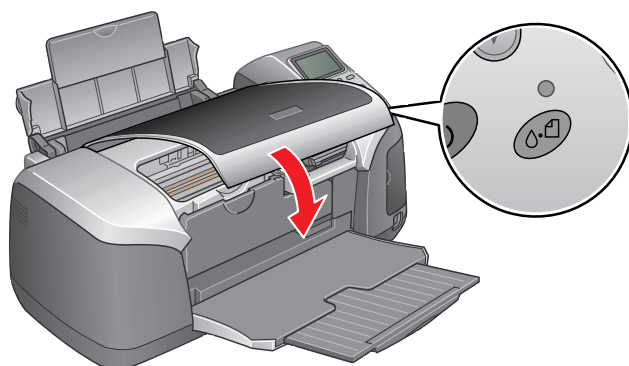

- 10** After ink charging is finished, press **OK**.



4 Load Paper

- 1 Fan a few sheets of paper and load them against the right side of the sheet feeder.
- 2 Slide the left edge guide against the paper.

NOTE: For instructions on loading and printing on CDs or DVDs, see your User's Guide.

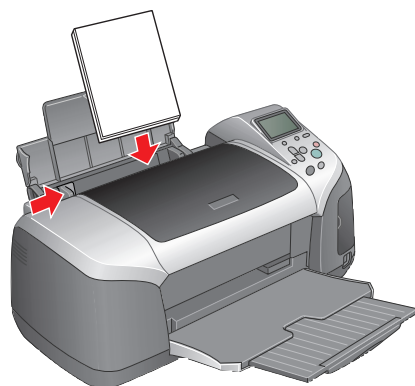

5 Install Software

Windows®

Make sure your printer is NOT connected to your computer, then follow the steps below.

- 1 Turn on your computer. Wait for the system to start up, then insert the EPSON® CD-ROM in your drive.

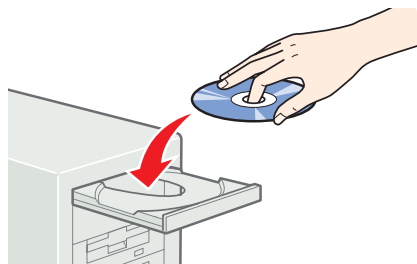

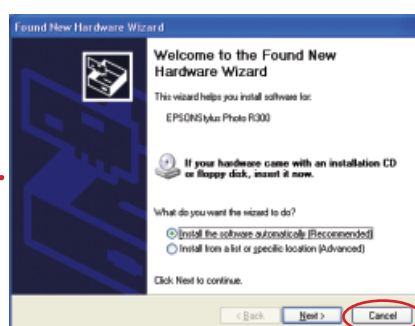

NOTE: If you see a screen like this, click **Cancel** and disconnect the printer from your computer.

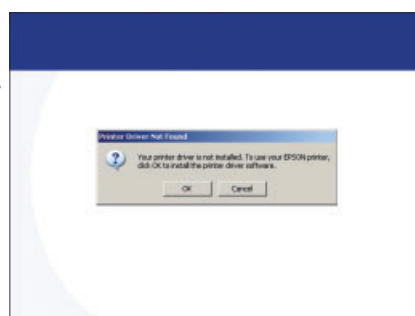

- 2 Read the license agreement that appears and click **Agree**.
- 3 You see a message like this:
Click **OK** to begin installing your printer driver.



- 4 When you see this screen, connect the  square end of your USB cable to the back of the printer and the  flat end of the USB cable to your computer. (You can connect to any open port.)

NOTE: For Windows XP, if you don't have USB 2.0, you see a message. Click the **Close** button to close the message.

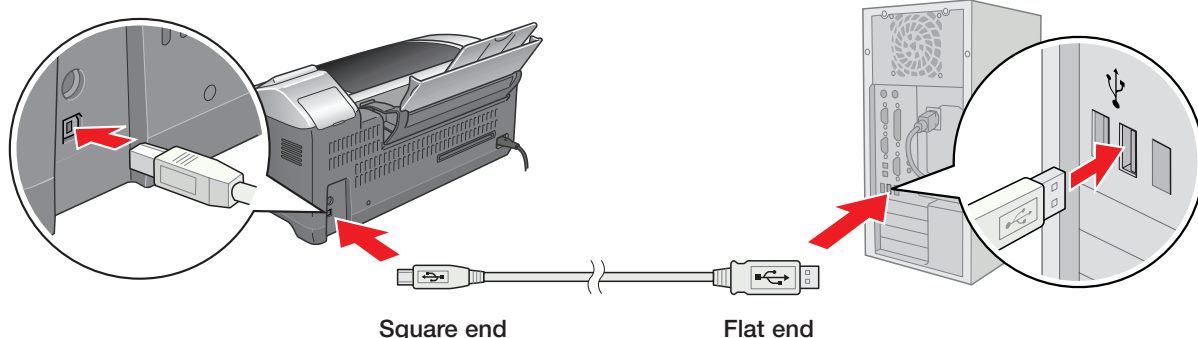

Wait while Windows detects your hardware.

- 5 When you see this screen, click **Continue**.
- 6 Follow the on-screen instructions to install your software.



continue

7 When installation is complete, you see this screen:

To install EPSON Software™ Film Factory™, click **EPSON Software Film Factory**, then click **Install**. Follow the on-screen instructions. When installation is complete, click **Back**.

If you're using Adobe® Photoshop® 6, 7 or Adobe Photoshop Elements 1 or 2, click **P.I.M. II Plug-In**, then click **Install**. Follow the on-screen instructions. When installation is complete, click **Back**.

To add a link to EPSON PhotoCenter,™ click **EPSON PhotoCenter Link**, then click **Add**. Click **Back**.



8 When you're done installing software, click **Exit**. The registration screen appears.



9 Follow the on-screen instructions to register your printer.

10 When you see a message telling you to restart your computer, click **OK**. Remove the CD, then restart your computer.

NOTE: Be sure to restart your computer to enable all of your printer software features.

You're ready to print! See section 6, "Print."

Macintosh®

1 Connect your printer to your computer: connect the  square end of your USB cable to the printer and the  flat end of the USB cable to your computer.

(You can connect to any open port.)

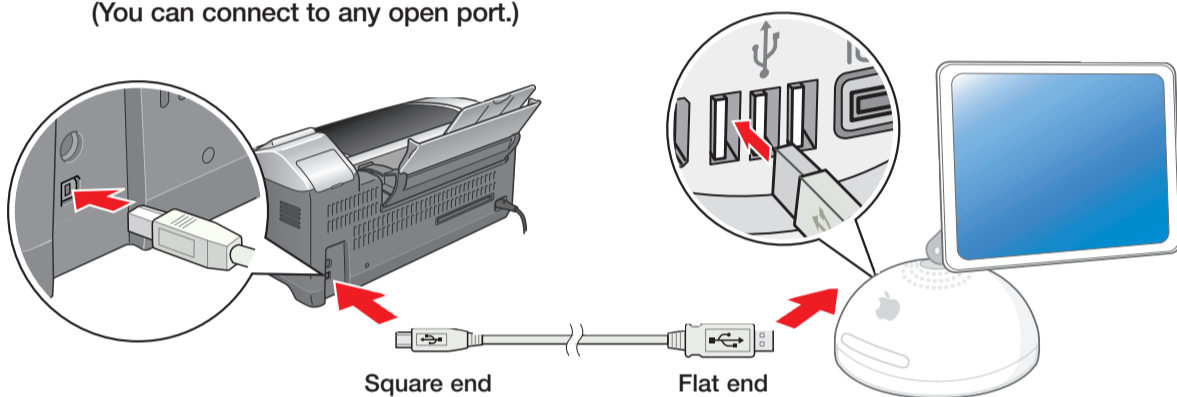

2 Turn on your Macintosh and wait for it to start up.

3 Insert the EPSON CD-ROM in your drive.

4 Double-click the CD-ROM icon, if necessary, then double-click  EPSON.

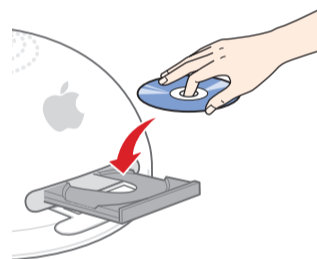

5 Read the license agreement that appears and click **AGREE**.

You see the Install Menu.

6 Click **Install Printer Driver and Utilities** and follow the on-screen instructions. (In OS X, you will need to enter your Administrator password for each item.)



7 When prompted, click **Restart** to restart your computer.

8 When your system restarts, double-click the CD-ROM icon, if necessary, then double-click  EPSON.

9 Click **Install EPSON Print CD**, then click **Install** and follow the on-screen instructions.

10 Click **Install Optional Software**. You see the following menu:



11 To install EPSON Software Film Factory, click **EPSON Software Film Factory**, then click **Install**. Follow the on-screen instructions. When installation is complete, click **Back**.

If you're using Adobe Photoshop 6, 7 or Adobe Photoshop Elements 1 or 2, click **P.I.M. II Plug-In**, then click **Install**. Follow the on-screen instructions. When installation is complete, click **Back**.

To add a link to EPSON PhotoCenter, click **EPSON PhotoCenter Link**, then click **Add**. Click **Back**, then click **Back** again.

12 From the Install Menu, click **Install Printer Manual** to install your on-screen Reference Guide.

13 When you're done installing software, click **Exit**. The registration screen appears.

14 Follow the on-screen instructions to register your printer.

Go to the section for your operating system to finish setting up your printer.

continue

Mac OS X 10.x

- 1 Open the **Applications** folder, then open the **Utilities** folder and select **Print Center**. You see the Printer List window.

If the Stylus Photo R300 appears in the printer list, go to step 2. If you don't see it, make sure your printer is turned on and connected. Then click **Add** or **Add Printer**, and select **EPSON USB** at the top of the screen and **Stylus Photo R300** below. Then go to step 3.

- 2 Click the **Stylus Photo R300** printer name and then click the **Add** or **Add Printer** button. You see another window listing your printer.

If it isn't already selected, choose **EPSON USB**.

- 3 Click the printer name, then open the Page Setup menu at the bottom of the screen and select **All**.

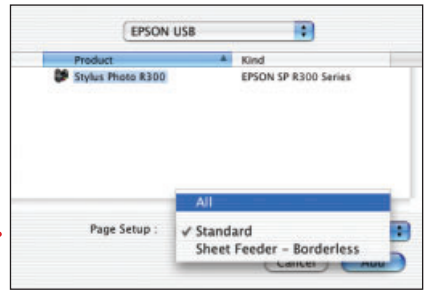

- 4 Click the **Add** button. You see the Printer List again with the printer features available.

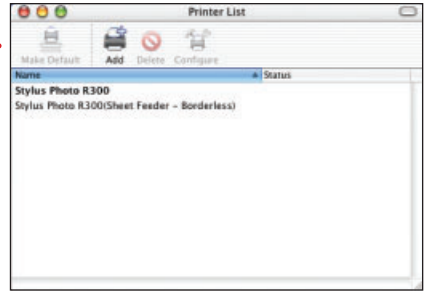

- 5 Close Print Center.

You're ready to print! See section 6, "Print."

NOTE: To print from Macintosh Classic applications in OS X, restart your Macintosh in OS 9 and follow the "Install Software" steps again.

Macintosh OS 8.6 to 9.x

Open the **Chooser** from the Apple® menu, then select these options:

- **SP R300 Series**
- Your **USB** port
- Background printing (on or off)

Close the **Chooser**.

You're ready to print! See section 6, "Print."

6 Print

Now you're ready to print. For instructions, use these resources:

- Your *User's Guide*

Learn about loading paper, printing, maintaining your printer, solving problems, and contacting EPSON.

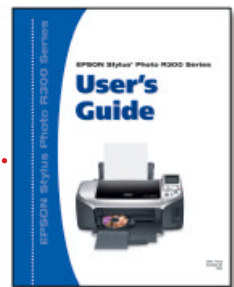

- Your *Quick Reference* card

See how easy it is to print without a computer.

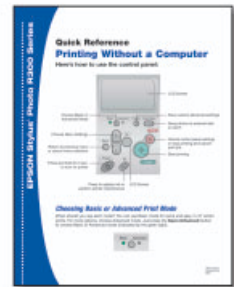

- Your on-screen *Reference Guide*

Double-click the **SPR300 Reference Guide** icon on your desktop to view more information about your printer.