

SANYO

INSTRUCTION MANUAL

DC-MX40i

Micro Hi-Fi System for iPod

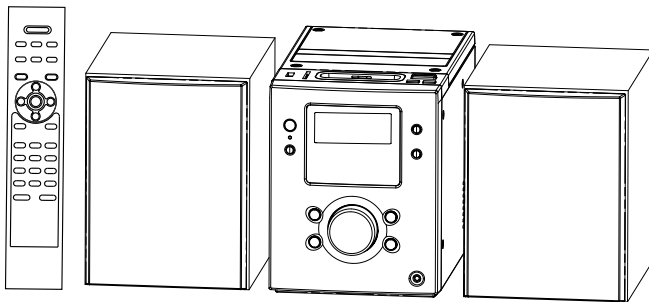

iPod is a trademark of Apple Inc.,
registered in the U.S. and other countries.
iPod shown not included.

"Made for iPod" means that an electronic accessory has been designed to connect specifically to iPod and has been certified by the developer to meet Apple performance standards. Apple is not responsible for the operation of this device or its compliance with safety and regulatory standards.

TABLE OF CONTENTS

SAFETY PRECAUTIONS.....	1
FEATURES AND CONTROLS.....	3
REMOTE CONTROL.....	4
LCD DISPLAY WINDOW.....	4
PUTTING THE BATTERIES INTO THE REMOTE CONTROL UNIT.....	5
INSTALLING THE SPEAKER WIRE TO THE SPEAKER TERMINALS.....	5
OPERATING THE UNIT.....	5
STANDBY/ON.....	5
CLOCK SETTING.....	6
TIMER SETTING.....	6
FUNCTION SELECT.....	6
RADIO OPERATION.....	6
CD/MP3/WMA OPERATION.....	7
ID3 OPERATION (on the remote control).....	8
USB/SD CARD OPERATION.....	8
REPEAT PLAY FUNCTION (on the remote control).....	9
PROGRAM FUNCTION.....	9
RANDOM PLAY (on the remote control).....	10
INTRO PLAY(on the remote control).....	10
iPod OPERATION.....	11
AUX IN PLAY.....	12
TO SET SLEEP FUNCTION (on the remote control).....	12
EQ CONTROL(on the remote control).....	12
MUTE SETTING(on the remote control).....	12
LISTEN TO THE MUSIC BY USING HEADPHONE.....	12
COMPACT DISC.....	13
SPECIFICATION.....	14
MAINTENANCE.....	14
TROUBLESHOOTING.....	15

SAFETY PRECAUTIONS

To achieve the utmost in enjoyment and performance, please read this manual carefully before attempting to operate the unit in order to become familiar with its features, and assure you years of faithful, trouble free performance and listening pleasure.

Important Notes

- * Read instructions - All the safety and operating instructions should be read before the apparatus is operated
- * Retain instructions - The safety and operating instructions should be retained for future reference.
- * Cleaning Unplug this product from the wall outlet before cleaning. Do not use liquid cleaners or aerosol cleaners. Use a damp cloth for cleaning.
- * Attachment Do not use attachment not recommended by the product manufacturer as they may cause hazards.
- * Power Sources -The apparatus should be connected to a power supply only of the type described in the operating instructions of as marked on the apparatus.
 - * "To be completely disconnected the power input, the mains plug of apparatus shall be disconnected from the mains." as the disconnect devices is the mains plug of apparatus.
- * Power-Cord Protection - Power supply cords should be routed so that they are not likely to be walked on or pinched by items placed upon or against them, paying particular attention to cords at plugs, convenience receptacles and the point where they exit from the apparatus
- * During Intended Use - The mains plug of apparatus should be easily accessed.
- * Nonuse Periods - The power cord of the apparatus should be unplugged from the outlet when left unused for a long period of time.
- * This apparatus shall not be exposed to dripping or splashing water and that no object filled with liquids such as vases shall be placed on the apparatus.
- * The apparatus should be situated so that its location or position does not interfere with its proper ventilation. The ventilation should not be impeded by covering the ventilation openings with items such as newspaper, table-cloths, curtains etc.
- * Do not install this apparatus in a confined space, such as a book case or built-in cabinet. Minimum distance (about 100mm) around the apparatus for sufficient ventilation.
- * No naked flame sources such as lighted candles should be placed on the apparatus.
- * Do not use where there are extremes of temperature (below 5°C or exceeding 35°C).
- * Sudden changes in the ambient temperature may cause condensation to form on the optical lens inside the unit. If this happens, take out the disc, leave the unit for about 1 hour, and then proceed to operate.
- * Because of the CD player's extremely low noise and wide dynamic range, there might be a tendency to set the volume on the amplifier unnecessarily high.
- * Excessive sound pressure from earphones and headphones can cause hearing loss.
- * Battery shall not be exposed to excessive heat such as sunshine, fire or the like.
- * Attention should be drawn to the environmental aspects of battery disposal.
- * The caution marking was located at the back enclosure of the apparatus.
- * The nameplate marking was located at the back enclosure of the apparatus.
- * The use of apparatus in moderate climates.

ESD Remark: In case of malfunction due to electrostatic discharge, just reset the product (reconnect of power source may be required) to resume normal operation. Should any trouble occur, remove the power source and refer servicing to qualified personnel.

WARNING : TO PREVENT FIRE OR SHOCK HAZARD, DO NOT EXPOSE THIS APPLIANCE TO DRIPPING OR SPLASHING.

For safety reasons, do not remove any covers or attempt to gain access to the inside of the product. Refer any servicing to qualified personnel.

Do not attempt to remove any screws, or open the casing of the unit; there are no user serviceable parts inside, refer all servicing to qualified service personnel.

Note:

- This unit will become warm when used for a long period of time. This is normal and does not indicate a Problem with the unit.
- The CD player includes micro-processors which may malfunction as a result of external electrical Interference or noise. If the CD player is not working properly, disconnect the power source and then reconnect it.
- Excessive sound pressure from earphones and headphones can cause hearing loss.
- If an unusual conditions occurs in the display window or key button, switch the unit off, then turn on the unit again.



You can see this carved picture on the bottom of the main unit.



This symbol indicates that dangerous voltage constituting a risk of electric shock is present within this unit.



This symbol indicates that there are important operating and maintenance instructions in the information accompanying this unit.



You can see this carved picture on the bottom of the main unit.

CAUTION

CLASS 1 LASER PRODUCT

Operating the unit in a way other than specified herein, or making adjustments to the unit may result in hazardous radiation exposure



LASER SAFETY

This unit employs a laser. Only qualified service personnel should attempt to repair.

You can see this label in the CD compartment.

WARNING: RISK OF INVISIBLE LASER RADIATION WHEN CD LID IS OPEN OR INTERLOCKS FALL. AVOID DIRECT EXPOSURE TO THE BEAM.



You can see this label on the back of the main unit.

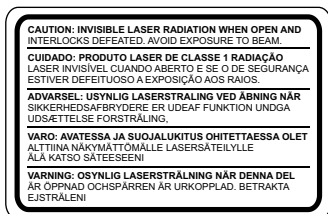

This label sticks inside of the unit.

FEATURES AND CONTROLS

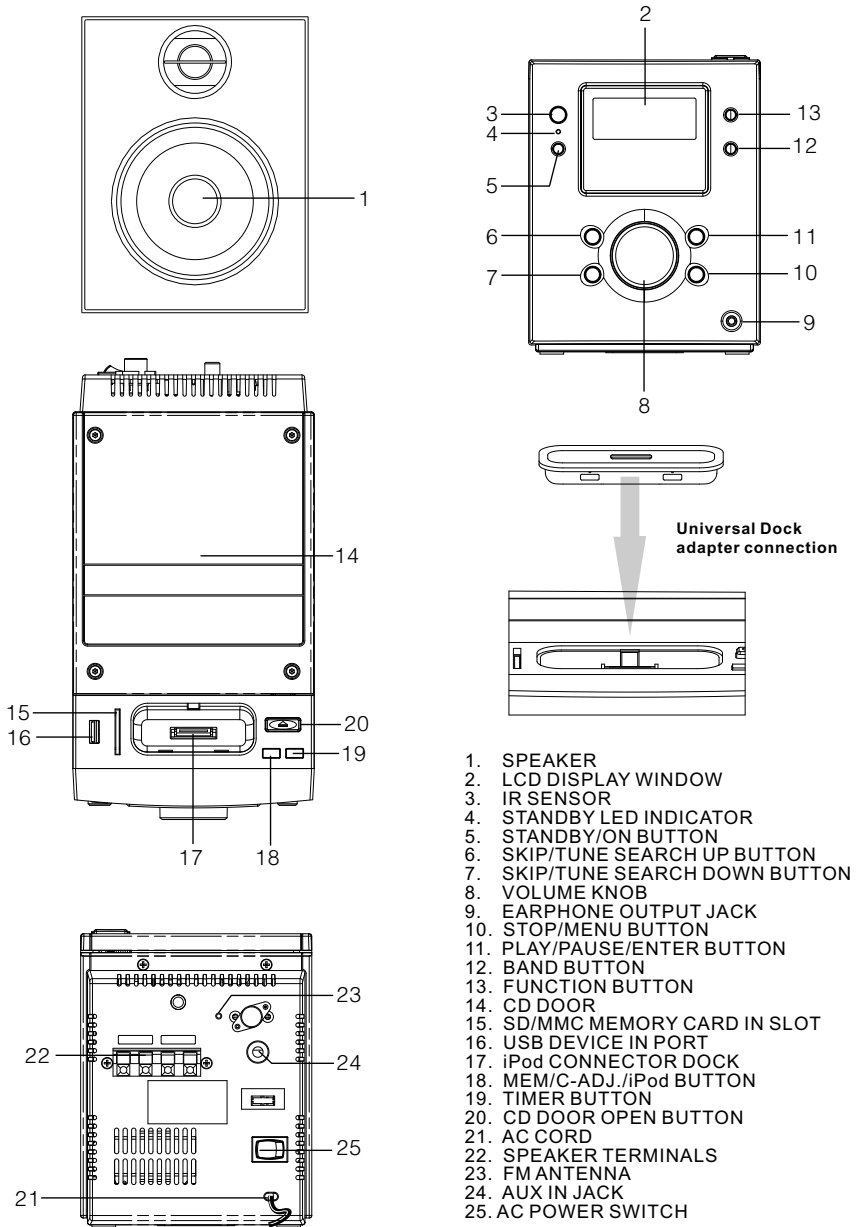

1. SPEAKER
2. LCD DISPLAY WINDOW
3. IR SENSOR
4. STANDBY LED INDICATOR
5. STANDBY/ON BUTTON
6. SKIP/TUNE SEARCH UP BUTTON
7. SKIP/TUNE SEARCH DOWN BUTTON
8. VOLUME KNOB
9. EARPHONE OUTPUT JACK
10. STOP/MENU BUTTON
11. PLAY/PAUSE/ENTER BUTTON
12. BAND BUTTON
13. FUNCTION BUTTON
14. CD DOOR
15. SD/MMC MEMORY CARD IN SLOT
16. USB DEVICE IN PORT
17. iPod CONNECTOR DOCK
18. MEM/C-ADJ./iPod BUTTON
19. TIMER BUTTON
20. CD DOOR OPEN BUTTON
21. AC CORD
22. SPEAKER TERMINALS
23. FM ANTENNA
24. AUX IN JACK
25. AC POWER SWITCH

REMOTE CONTROL

1. STANDBY/ON BUTTON
2. MUTE BUTTON
3. PRESET/FOLDER UP BUTTON
4. PRESET/FOLDER DOWN BUTTON
5. RANDOM BUTTON
6. SKIP/TUNE SEARCH DOWN BUTTON
7. INTRO BUTTON
8. VOLUME DOWN BUTTON
9. FUNCTION BUTTON
10. BAND BUTTON
11. ID3/MONO/STEREO BUTTON
12. REPEAT BUTTON
13. PLAY/PAUSE/ENTER (only in iPod) BUTTON
14. EQ BUTTON
15. SKIP/TUNE SEARCH UP BUTTON
16. STOP/MENU (only in iPod) BUTTON
17. iPod/MEM/C- ADJ. BUTTON
18. TIMER BUTTON
19. SLEEP BUTTON
20. NUMBER SEARCH BUTTON
21. VOLUME UP BUTTON

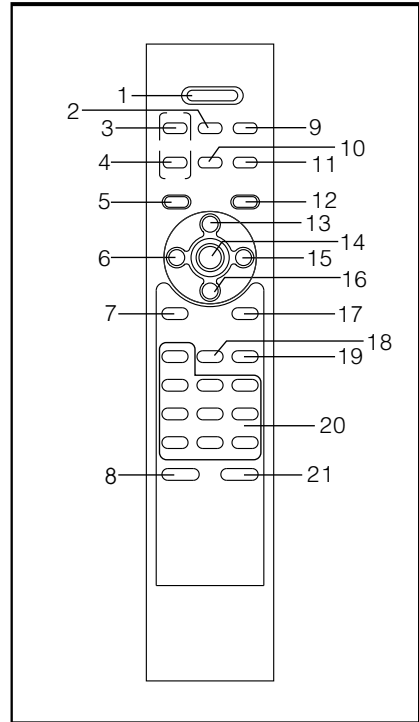

LCD DISPLAY WINDOW

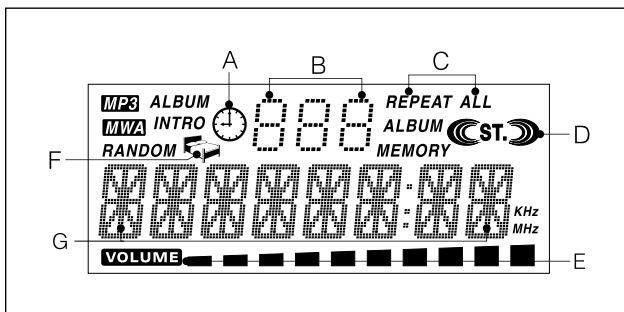

- | | |
|---------------------------------|--------------------------------|
| A. TIMER INDICATOR | D. STEREO INDICATOR |
| B. ALBUM/RADIO MEMORY INDICATOR | E. VOLUME HIGH/LOW INDICATOR |
| C. REPEAT 1 & ALL INDICATOR | F. SLEEP INDICATOR |
| | G. TRACK/NUMBER/TIME INDICATOR |

PUTTING THE BATTERIES INTO THE REMOTE CONTROL UNIT

Press down the compartment cover, and slide the cover off to open the compartment. Place the two (UM4), (AAA), (R03) batteries in the remote control according to the polarity markings ("+" and "-") inside the compartment and on the batteries. Place the cover over the compartment, press down lightly, and push it upward until it snaps on.

BATTERY PRECAUTIONS

Follow these precautions when using a battery in this device:

1. Warning -Danger of explosion if battery is incorrectly replaced. Replace only with the same or equivalent type.
2. Use only the size and type of battery specified.
3. Be sure to follow the correct polarity when installing the battery as indicated in the battery compartment.
4. A reversed battery may cause damage to the device.
4. If the device is not to be used for a long period of time, remove the battery to prevent damage or injury from possible battery leakage.
5. Do not try to recharge a battery not intended to be recharged; it can overheat and rupture. (Follow battery manufacturer's directions.)
6. Battery shall not be exposed to excessive heat such as sunshine, fire or the like.

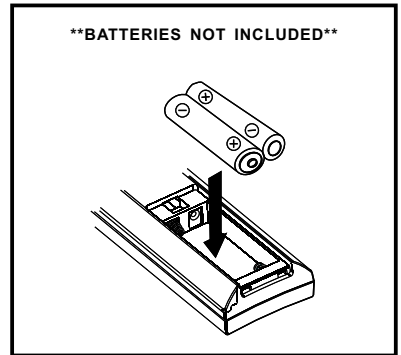

INSTALLING THE SPEAKER WIRE TO THE SPEAKER TERMINALS

1. Speakers Connection

Extend the SPEAKER WIRES and connect them to the SPEAKER TERMINALS.

2. Power Cord Connection

Before using, connect the AC Power Cord to 240V AC outlet. Then turn on the main switch on the rear of the unit. The STANDBY indicator will light on.

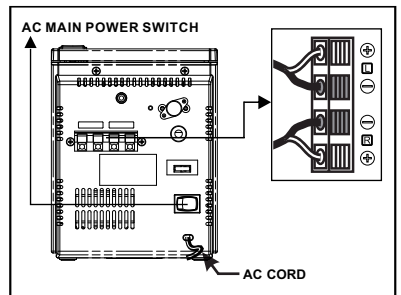

OPERATING THE UNIT

Before operating the unit for the first time, make sure the AC power cord is properly connected to a 240V 50Hz AC outlet, then press the power ON switch on the rear of the unit, the unit will be in standby mode. The STANDBY indicator will light on. You can now press the STANDBY/ON button on the unit or press the STANDBY/ON button on remote control to switch the unit ON. The STANDBY indicator will be off. Pull the AC plug out of the wall socket if you want to switch off completely.

STANDBY/ON

1. Press the STANDBY/ON button on the unit or remote control to switch the unit on.
2. Select the sound source (CD, USB, CARD, iPod, AUX or TUNER) by pressing FUNCTION button. The corresponding display will light up.
3. Adjust the volume with the VOLUME (+ or -) knob on the unit or VOLUME (+ or -) button on the remote control.
4. Press the STANDBY/ON button on the unit or remote control again to turn off the unit.

Note: 1. During in standby mode, press any button/key can make the display light for 10 seconds.

2. Please turn the main switch off to save energy, when you do not use the unit.

CLOCK SETTING

During in the STANDBY mode.

1. Press and hold the MEM/C-ADJ./iPod button until the time displays will change to 24-hour digit and flash.
2. Press ◀◀ or ▶▶ button to select 12-hour or 24-hour.
3. Press the MEM/C-ADJ./iPod button again, the HOUR digit will flash on the display, press ◀◀ or ▶▶ button to adjust HOUR digit.
4. Press the MEM/C-ADJ./iPod button once more, the MINUTE digit will flash on the display, press ◀◀ or ▶▶ button to adjust minute digit.
5. Press the MEM/C-ADJ./iPod button again to confirm the time.
6. Each enable state as shown above will be cleared if the key is not pushed in 10 seconds.

TIMER SETTING

1. After adjusting the clock, press the TIMER button for a few seconds, "⌚ ON" and "00:00" appear on the display and the HOUR digit flashes.(F1)
2. Press ◀◀ or ▶▶ on the unit or press ◀◀ or ▶▶ button on the remote control to adjust it.
3. Press the TIMER button again, the MINUTE digit will start flashing, adjust it by pressing ◀◀ or ▶▶ on the unit or pressing ◀◀ or ▶▶ button on the remote control.
4. Press the TIMER button once more to confirm and order TIMER ON time.
5. After adjusting "TIMER ON", "⌚ OFF" appears on the display and the HOUR digit flashes.(F2)
6. Repeat the above steps 2 to 3, and then press the TIMER button once more to confirm and order TIMER OFF time.
7. Now the "TUNER" appears on the display with flashing, and then select the alarm mode of the "TUNER, CD, USB, CARD or IPOD" by pressing ◀◀ or ▶▶ on the unit.
8. Press the TIMER button again, the timer "VOL" indicator appears on the display and flashes, adjust the timer volume high or low by pressing ◀◀ or ▶▶ on the unit or pressing the ◀◀ or ▶▶ button on the remote control.
9. Each enable state as shown above will be cleared if the button is not pushed in 10 seconds.
10. After adjusting "TIMER ON" and "TIMER OFF", press the TIMER button, "⌚ " appears on the display.
11. The main unit will be switched on automatically at "TIMER ON" order and start playing, the main unit will be switched off automatically at "TIMER OFF" order.

Note: If the display shows "ERROR" while you set the "TIMER ON", it means both "TIMER ON" and "TIMER OFF" is the same. In this case, please go to "TIMER OFF" to set the off time first. To switch TIMER function ON or OFF, press TIMER button.

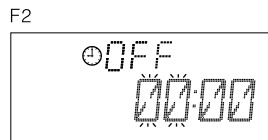
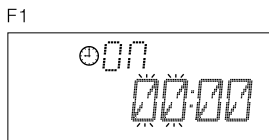

FUNCTION SELECT

The function is that when pressing FUNCTION button, the mode is changed. Display changes as below:



RADIO OPERATION

Press the FUNCTION button to select "TUNER".

1. Press the BAND button to select AM or FM.
2. Press ◀◀ or ▶▶ button to tune the desired station.

Manual Tuning

To tune for weak stations, use manual tuning by pressing ◀◀ or ▶▶ button continuously until you read the correct frequency or the reception is at its best.

Automatic Tuning

1. Press ◀◀ or ▶▶ button for a second or more, then release the button. The tuner will automatically search the first station of sufficient signal strength.
2. Repeat above procedure if you wish to select another station.

Mono/stereo select (on the remote control)

You can select the MONO/STEREO only in FM mode.

1. When you want to select FM stereo station, press the ID3/MONO/ST. button on the remote control. When you receive a FM stereo station the "Ⓒ st. Ⓓ" indicator will appear on the display, you can receive FM stereo transmission.
2. When you press the ID3/MONO/ST. button on the remote control again, the FM STEREO indicator will turn off and switch to MONO FM status.

Programming preset stations

You can also preset stations of your choice and store up to 10 AM and 30 FM stations in its memory. To store your selected broadcasting stations:

1. Press the BAND button on the unit(or remote control) to toggle between AM and FM to make your selection.
2. Tune to the desired station.
3. Press the MEM/C-ADJ./iPod button.
4. Press the PRESET/FOLDER (Up or DOWN) button on the remote control for your desired station number.
5. Press the MEM/C-ADJ./iPod button again to confirm your selection.
6. To program more stations into memory, repeat the above steps 2 to 5.
7. To change the stored preset stations, repeat the above steps 2 to 5.

Note: Storing a new station into a preset location will erase the previously stored station in that location.

Selecting the Preset Stations

1. Press the BAND button to select the desired band.
2. Press the PRESET/FOLDER (UP or DOWN) button on the remote control to select the desired preset station number.
3. The location number of preset station is displayed along with the corresponding frequency.

FM Antenna

For better FM reception change the position of FM antenna wire.

CD/MP3/WMA OPERATION

Listening To Compact Disc (CD/MP3/WMA)

1. If you want to enjoy CD/MP3, press the CD DOOR OPEN(▲) button once on the unit first, and then the CD door will open automatically.(F3)
2. Insert the CD or MP3 disc into the CD compartment, press the CD door to close it.
3. Press the FUNCTION button to select CD mode. The unit will read the CD/MP3/WMA disc automatically.

Note: (1) This unit can play CD, CD-R, CD-RW, MP3 and WMA discs.

- (2) It can read " 8 cm " and " Multi Section " of MP3 DISC.
- (3) The "Playback Transfer Rate" in MP3 and WMA.
 - a. In MP3, transfer bit rate : 8 - 256 kbps.
 - b. In WMA, transfer bit rate : 8 - 192 kbps.
- (4) The "Max Readable 99 folders and 999 tracks".
- (5) If no disc or can't read TOC, NO DISC will be displayed.(F4)

F3

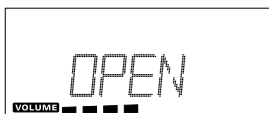

F4

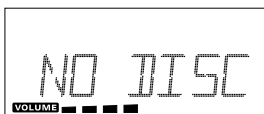

Playing The Entire CD/MP3/WMA

- CD

1. Insert the CD disc into the CD compartment, and then press FUNCTION button to select CD mode, the main unit will automatically read the total number of the tracks at the same time.
2. Press ►/II/ENTER button, the unit will play the first track of the CD disc automatically.(F5)
3. Press ►/II/ENTER button once again, the time elapsed indicator will flash.(F6)
4. Press ◀◀ or ▶▶ button once to change Track NO., and press and hold ◀◀ or ▶▶ button to skip fast backward or forward of each song.
5. To resume playback, press ►/II/ENTER button once more again.
6. To stop playback, press ■/MENU button once.

IMPORTANT INFORMATIONS

- Copyright protection files cannot be played back.
- Copyright protection files on a disc are skipped automatically when played back.

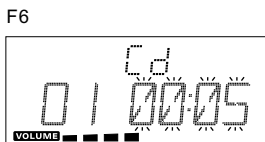
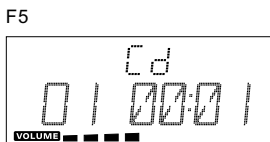

- MP3/WMA

1. Insert the MP3/WMA disc into the CD compartment, and then press FUNCTION button to select CD mode, the main unit will automatically read the total number of the folders and tracks at the same time.
2. Press ►/II/ENTER button, the unit will play the first track of the MP3/WMA disc automatically. (F7)
3. Press ►/II/ENTER button once again, the time elapsed indicator will flash. (F8)
4. To change Track NO., Press ◀◀ or ▶▶ button once. And press and hold ◀◀ or ▶▶ button to skip fast backward or forward of each song.
5. To resume playback, press ►/II/ENTER button once more again..
6. To change the ALBUM NO., press the PRESET/FOLDER UP or DOWN button on the remote control.
7. To stop playback, press the ■/MENU button once on the unit (or remote control).

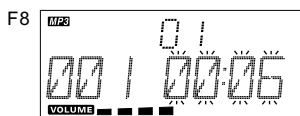
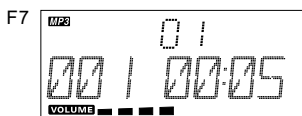

Note: If the main unit is not working properly, disconnect the power source and then reconnect it again.

ID3 OPERATION (on the remote control)

During in the MP3/WMA mode

1. Press the ID3/MONO/ST. button once to open the ID3 function.
2. If the MP3/WMA file is written in "ID3" it will automatically to search the information of "TITLE NAME", "ARTIST NAME" and "ALBUM NAME" indicated on the display.



3. Press the ID3/MONO/ST. button on the remote control again. Then the unit will resume to play normally.

USB/SD CARD OPERATION

During in the STANDBY mode

1. Insert the USB DEVICE or SD/MMC CARD, and then press the STANDBY/ON button on the main unit (or remote control) to power "ON" the unit.
2. Press the FUNCTION button on the main unit (or remote control) to select the USB or CARD mode. The main unit will automatically read the total number of the folders and tracks at the same time. (F9)
3. If the USB memory device more than one folder.
 - a. Press the PRESET/FOLDER (UP or DOWN) button on the remote control to select each folder.
 - b. Press ◀◀ or ▶▶ button to select a track in desired folder.
4. Press ►/II/ENTER on the unit or press the ►/II/ENTER button on the remote control, will start playback from the selected track. The display shows the current track number and its elapsed time. (F10)
5. To pause playback, press ►/II/ENTER on the unit or press the ►/II/ENTER button on the remote control. The time elapsed indicator will flash. (F11)
6. To resume playback, press ►/II/ENTER on the unit or press the ►/II/ENTER button on the remote control again.
7. To stop playback, press ■/MENU.

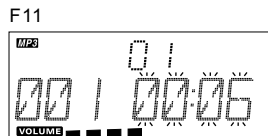
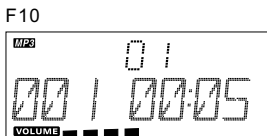
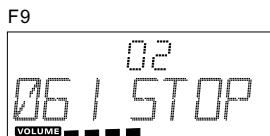

- Note:**
1. In any time, the USB DEVICE or SD CARD must be fixed well under in the STANDBY mode to avoid the main unit and USB DEVICE or SD CARD were damaged.
 2. This unit can support most of USB devices and SD/MMC cards. The memory capacity up-to 2GB. It can not access (or access a longer time) the memory capacity over 2GB. Otherwise, make an others to access it.
 3. It can support USB version 1.1 and 2.0.
 4. Not support all kinds of " dual voltage-MMC" card nor "MMC-Plus" card.
 5. The main unit does not support the WMA file which is protected "DRM FILE".

IMPORTANT INFORMATIONS

- Copyright protection files cannot be played back.
- Copyright protection files on the USB memory and SD/MMC card device are skipped automatically when played back.
- Recommended use:
Flash memory type USB memory player
- Not recommended:
Hard disc memory type USB player
- Some Flash memory player will not play successfully with this unit.

REPEAT PLAY FUNCTION(on the remote control)

- CD

1. Press the REPEAT button once on the remote control, "REPEAT" is displayed. CD will play the current track repeatedly.(F12)
2. Press the REPEAT button again, "REPEAT ALL" is displayed. CD will play all tracks repeatedly.(F13)
3. Press the REPEAT button once more again, REPEAT function will be off.

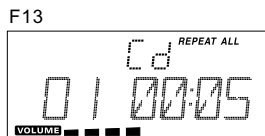
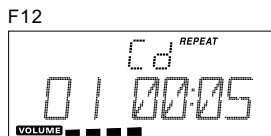

- MP3/WMA/USB/SD CARD

1. Press the REPEAT button once on the remote control, then "REPEAT" is displayed. It will play the current track repeatedly.(F14)
2. Press the REPEAT button again, "REPEAT ALL" is displayed. It will play all tracks repeatedly.(F15)
3. Press the REPEAT button again, "REPEAT ALBUM" is displayed. It will play all tracks in the current folder repeatedly.(F16)
4. Press the REPEAT button once more again, then REPEAT function will be off.

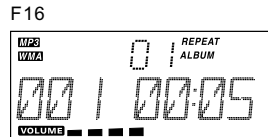
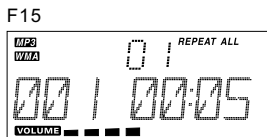
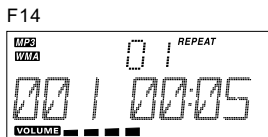

PROGRAM FUNCTION

You can make the program up to 32 tracks in CD mode or 64 tracks in MP3/WMA/USB/SD CARD mode in any desired order. Program mode is activated while in stop mode.

1. Programme

- CD

- 1) Press the MEM/C-ADJ./iPod button in stop mode, shift to MEMORY mode.(F17)
- 2) Press ◀◀ or ▶▶ button, the track number will be changed.
- 3) Press the MEM/C-ADJ./iPod button to confirm the track number.

- MP3/WMA

- 1) Press the MEM/C-ADJ./iPod button in stop mode, shift to MEMORY mode. The album number is flashing. (F18)
- 2) Press the PRESET/FOL UP or DOWN button on the remote control, the album number will be changed.
- 3) Press the MEM/C-ADJ./iPod button, the first track number will be displayed.(F19)

- 4) Press ◀◀ or ▶▶ button, the track number will be changed.
- 5) Press the MEM/C-ADJ./iPod button to confirm the favorite track number.

F17

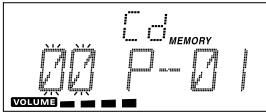

F18

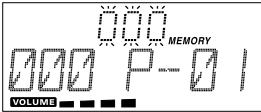

F19

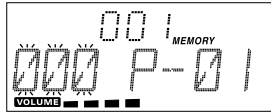

2. PROGRAM PLAY

Press ▶/II/ENTER button on the unit (or remote control). The unit will play the first track of the program. When all tracks have been played, the unit will stop automatically. If you want to listen program play again. Press ▶/II/ENTER again.

3. CANCEL PROGRAM

1. Press ■/MENU button twice, or open the CD tray door and close it again that the memory will be erased.
2. Set a new program, the existing one will be cleared.

4. Checking the programme

During stop mode, the display will show the corresponding programmed song when press the MEM/C-ADJ./iPod Button.

Note : During in the program mode.

1. Press the REPEAT button on the remote control once, the "REPEAT" indicator will light on the display. Then the unit will repeat the current track.
2. Press the REPEAT button on the remote control again, the "REPEAT ALL" will light on the display. Then the unit will repeat all the programmed tracks.
3. Press the REPEAT button on the remote control once more again. The unit will return to play the program in normally.

RANDOM PLAY(on the remote control)

1. Press the RANDOM button on the remote control, then RANDOM is displayed.(F20)
2. Press the RANDOM button again, then the unit will resume to normally play.

F20

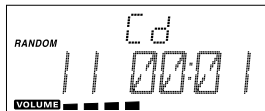

INTRO PLAY(on the remote control)

1. Press the INTRO button on the remote control, INTRO is displayed. will play the first 10 seconds of each track.(F21)
2. Press the INTRO button again, then the unit will resume to normally play.

F21

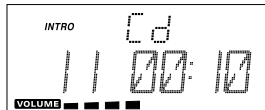

During the unit in STANDBY mode:

1. Insert the iPod players in the iPod docking bracket on the top of the main unit fixedly.
2. Power on the main unit, and then press the FUNCTION button to select iPod mode, the iPod indicator will appear on the main unit display. (F22)

F22

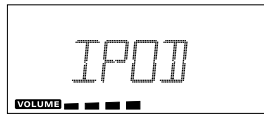

During the unit in iPod mode:

1. Press ►/II/ENTER (only in iPod) button once to start the iPod playing. Adjust the volume control by turning the VOLUME (+ or -) knob. or press the VOLUME (+ or -) on the remote control. To stop the current playing, press ■/MENU (only in iPod) button once.
2. Press ►/II/ENTER (only in iPod) button once to pause the current track. To resume the playback, press ►/II/ENTER (only in iPod) button once again.
3. To skip forwards or backwards, press ◀◀ or ▶▶ button to select the desired track.
4. Press the REPEAT or RANDOM button on the remote control to make the iPod playing repeatedly or randomly.
Note: iPod touch version 1.1.4 or above can support REPEAT or RANDOM function.

During the unit in iPod MENU mode:

1. During the unit in iPod mode, press the MEM/C-ADJ./iPod button once, the unit will enter to the iPod MENU mode. The iPod MENU indicator will appear on the unit display. (F23)
2. Press ■/MENU (only in iPod) button repeatedly to go to the main menu in your iPod.
3. Press ◀◀ or ▶▶ button on the unit (or remote control) to search the menu on the iPod.
4. Press ►/II/ENTER (only in iPod) button to enter the selected menu folder.
5. Press ◀◀ or ▶▶ button on the unit (or remote control) to search the current content in the each desired menu folder.
6. To return to the previous menu, press ■/MENU.
7. To resume playback, press the MEM/C-ADJ./iPod button once again, the unit will return to iPod mode.

Charging the iPod Player battery through the main unit:

1. If the iPod player is connected to the unit. The iPod will be charged automatically.
2. You can charge the iPod Player in STANDBY MODE or POWER ON mode.

- Note :
1. The iPod Player battery is 80-percent charged in about one hour, and fully charged in about a few hours. If you charge it while playing music, it may take longer.
 2. It is not better to charge under the TUNER mode. It may interfere the reception.

Note:

1. In any time, you can control the iPod player on the main unit, remote control or iPod player itself while the unit in the "iPod" or "iPod MENU" mode.
2. In any time, the iPod player must be fixed well under in the STANDBY mode to avoid the unit and iPod player were damaged.
3. During the unit in iPod mode. If the video function of the iPod cannot work properly. Update the latest version of the iPod video function from the apple web-site.

F23

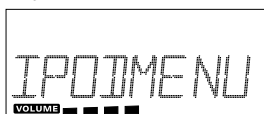

AUX IN PLAY

1. Use a cable with RCA jack to connect external audio source (DVD player, Mini Disc player, Cassette Deck etc.) to the AUX IN jack on the rear of the unit.
2. Press the FUNCTION button repeatedly until the "AUX" appears on the display.
3. Turn your auxiliary source "ON" and operate it as usual. The sound from the auxiliary source will be heard through the speakers of the unit.

Note: Aux in cable not included.

TO SET SLEEP FUNCTION(on the remote control)

1. If you want to fall asleep with music, press the SLEEP button.(F24)

F24

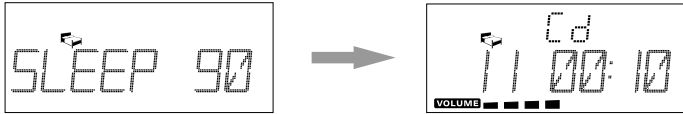

2. Press SLEEP button repeatedly to change and select from 90 to 80, 70, 60, 50, 40, 30, 20, 10 minutes. You may select the TUNER, CD, USB, CARD or IPOD mode in sleep function.
3. After the unit plays for your selected time, it will shut down automatically. While the SLEEP function is activated, press SLEEP button once and the remained sleep time will be shown. Press SLEEP button again to select another sleep time.



EQ CONTROL(on the remote control)

EQ shows the present sound tone.

When you press the EQ button, the sound tone changes as below:



MUTE SETTING(on the remote control)

1. When you press the MUTE button once on the remote control, the volume level will flash and the audio output will be temporarily terminated.(F24)
2. Press the MUTE button again, the volume level and the audio output will return to normal.

F24

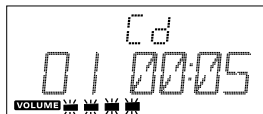

LISTEN TO THE MUSIC BY USING HEADPHONE

A stereo headphone jack is provided for private listening. To listen to the unit with headphones (not included) insert the 3.5mm mini-stereo plug into the PHONES jack on the front panel. The external speakers are automatically disconnected when headphones are using.

COMPACT DISC

1. Always use compact discs bearing the mark as shown.



2. Notes on handling discs
Removing the disc from its storage case and loading it.
 - * Do not touch the reflective recorded surface.
 - * Do not stick paper or write anything on the surface.
 - * Do not bend the disc.

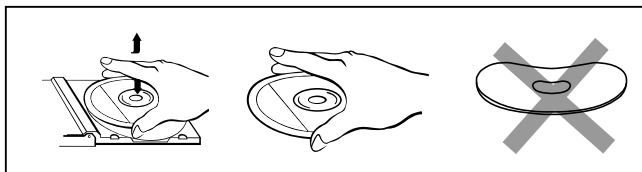

3. Storage
 - * Store the disc in its case.
 - * Do not expose discs to direct sunlight or high temperatures, high humidity or dusty places.
4. Cleaning a disc
 - * When the disc become soiled, wipe off dust, dirt and fingerprints with a soft cloth.
 - * The disc should be cleaned from the centre to the edge.

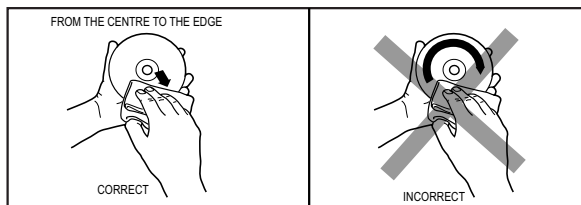

- * Never use benzene, thinners, record cleaner fluid or anti static spray.
- * Be sure to close the CD door so the lens is not contaminated by dust.
- * Do not touch the lens.

SPECIFICATION

POWER SUPPLY :	AC 240V~50Hz
OUTPUT POWER :	4.5 Watts x 2
UNIT DIMENSION :	135 (W) x 249 (D) x 170 (H) mm
SPEAKER BOX DIMENSION :	130 (W) x 160 (D) x 170 (H) mm
N. W. :	3.75kg

RADIO SECTION	
FREQUENCY RANGE :	FM 87.5 - 108 MHz AM 522 - 1620 kHz

COMPACT DISC SECTION

CD	Media	CD-DA, CD-ROM, CD-R, CD-RW
	Supported format	ISO 9660, UDF
	Type	2 channel stereo
	Pickup	Optical 3-beam semiconductor laser
	Laser output	0.6mW (Maximum continuous wave)
	Wave length	790nm
	Wow/Flutter	Below measurable limits
MP3 Decode	File	MPEG 3
	Bit rate (kbps)	8-320 constant & Variable bit rate (VBR)
	ID3 tag	Yes
	Max folder / file no.	USB 99/999 CD-rom and SD card 99/999
	Max files per folder	999
	Folder /file name	32/32 (maximum number of bytes)
	ID3 title / artist/album	64/64/64 (maximum number of bytes)
WMA Decode	File	Windows media audio 9
	Bit rate (kbps)	8-192
	Max folder / file no	USB 99/999 CD-rom and SD card 99/999
	Max files per folder	999
	Folder /file name	32/32 (maximum number of bytes)
	ID3 title/artist/album	64/64/64 (maximum number of bytes)
AUX input	Max voltage	500mV
	Impedance	47Ω
Operating conditions		Temperature: 5°C to 35°C Humidity 5% to 90%
Operating position		Horizontal

SPECIFICATION SUBJECT TO CHANGE WITHOUT FURTHER NOTICE.

Ventilation warning : " The normal ventilation of the product shall not be impeded for intended use."

MAINTENANCE

Cleaning the unit

Clean the outside of the unit with a clean soft cloth, moistened with lukewarm water. Do not use benzene, thinners, or alcohol since they will damage the finish of the surfaces.

Cleaning the CD player lens

The lens should never be touched. If dust is on the lens, blow it off using a camera lens blower (F. A). (Consult your dealer.)

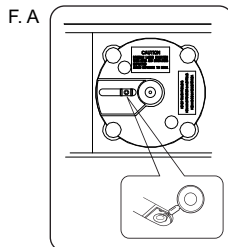

TROUBLE SHOOTING

SYMPTOM

POSSIBLE CAUSE CORRECTIVE ACTION

No power

No mains lead plug connection at the AC outlet.
Insert the plug into the AC outlet.

The power is on, but the CD player does not work.

No disc is loaded.
Load a disc.

Sound is heard from one speaker.

Faulty connection of speaker wires.
Connect the speaker wires firmly to the speaker terminals.

The CD player does not start playback. No disc is loaded.

Loaded a disc.
An unplayable disc is loaded. Load a playable disc.
The disc is not loaded correctly.
Load the disc with the label facing up on the disc tray.

The disc is dirty.

Clean the disc or replace it.

The CD player does not start playback and "NO FILE" appears.

An unplayable disc is loaded. Load a playable disc.
The disc is not loaded correctly.
Load the disc with the label facing up on the disc tray.

The remote controller does not work properly. The batteries in the remote controller are weak, or installed incorrectly.

Check the battery polarity (+ or -). Replace the battery.
The remote controller is not aimed at the remote sensor window.
Aim the remote controller at the remote sensor window.

No sound.

Volume control is set to minimum.
Turn up the volume.
The wrong function is selected.
Select the correct function.
Faulty speaker connections.
Connect the speaker wires firmly to the speaker terminals.

The operation of the unit or display is not normal.
The unit must be reset.

1. Disconnect the main lead and replug again.
 2. Resume operations.
-

The file in USB or SD card cannot play back. USB device is not connected.

Connect the USB device. SD card is not loaded.
Load the SD card.
The file is copyright protection file. Select the correct playable files.















FM stereo broadcast is hard to hear due to much noise.

Weak signal.
Press the ID3/MONO/ST. button on the remote control to display "MONO".
Reorient the FM aerial wire. Connect the speaker wires firmly to the speaker terminals.

The unit supports the listed iPods

****iPod charge and operation only****

*****iPods shown are not included*****

 <p>Made for iPod mini (4GB, 6GB only)</p>	 <p>Made for iPod (4th generation) (20GB only)</p>	 <p>Made for iPod (4th generation) (40GB only)</p>
 <p>Made for iPod with color display (4th generation) (20GB, 30GB only)</p>	 <p>Made for iPod with color display (4th generation) (40GB, 60GB only)</p>	 <p>Made for iPod with video (5th generation) (30GB only)</p>
 <p>Made for iPod with video (5th generation) (60GB, 80GB only)</p>	 <p>Made for iPod nano (1st generation) (1GB, 2GB, 4GB only)</p>	 <p>Made for iPod nano (2nd generation)(aluminum) (2GB, 4GB, 8GB only)</p>
 <p>Made for iPod nano (3rd generation)(video) (4GB, 8GB only)</p>	 <p>Made for iPod nano (4th generation) (8GB, 16GB only)</p>	 <p>Made for iPod classic (80GB, 160GB only)</p>
 <p>Made for iPod classic (2nd generation) (120GB only)</p>	 <p>Made for iPod touch (8GB, 16GB, 32GB only)</p>	 <p>Made for iPod touch (2nd generation) (8GB, 16GB, 32GB only)</p>

CODE NO.:116403062



SANYO Electric Co., Ltd.
Printed in China