

960 Owner's Manual

Volvo

960

1 9 9 3

This manual deals with the operation and care of your Volvo.



Welcome to the world-wide family of Volvo owners. We trust you will enjoy many years of safe driving in your Volvo, an automobile designed with your safety and comfort in mind. To ensure your satisfaction with this vehicle, we encourage you to familiarize yourself with the equipment descriptions, operating instructions and maintenance requirements/recommendations in this manual. We also urge you and your passengers to wear seat belts at all times in this (or any other) automobile. And, of course, please do not operate a vehicle if you may be affected by alcohol, medication or any impairment that could hinder your ability to drive.

Your Volvo is designed to meet all applicable safety and emission standards, as evidenced by the certification labels attached to the door opening sheet metal and on the left wheel housing in the engine compartment. For further information regarding these regulations, please contact your dealer.

The cover photograph shows the international version of the car.

Contents

Important

You should be familiar with the information in the first three chapters before you operate the car. Information contained in the balance of the manual is extremely useful and should be studied after operating the vehicle for the first time.

The manual is structured so that it can be used for reference. It should thus be kept in the car for ready access.

Do not export your Volvo to another country before investigating that country's applicable safety and exhaust emission requirements. In some cases it may be difficult or impossible to comply with these requirements. Modifications to the emission control system(s) may render your Volvo not certifiable for legal operation in the U.S., Canada and other countries.

Notice:

Your Volvo is designed to meet all applicable safety and emission standards, as evidenced by the certification labels attached to the door opening sheet metal and the left wheel housing in the engine compartment. For further information regarding these regulations, please contact your dealer.

All information, illustrations and specifications contained in this manual are based on the latest product information available at the time of publication. Volvo reserves the right to make changes at any time, or to change specifications or design, without notice and without incurring obligation.

© Volvo Cars of North America

[Instruments and controls ... 1](#)

[Body and interior ... 2](#)

[Occupant safety, Reporting Safety Defects ... 3](#)

[Starting and driving ... 4](#)

[Wheels and tires ... 5](#)

[In case of emergency ... 6](#)

[Car care ... 7](#)

[Service and routine maintenance ... 8](#)

[Specifications ... 9](#)



[Contents](#) | [Top of Page](#)

Instruments and controls

Instruments, switches and controls

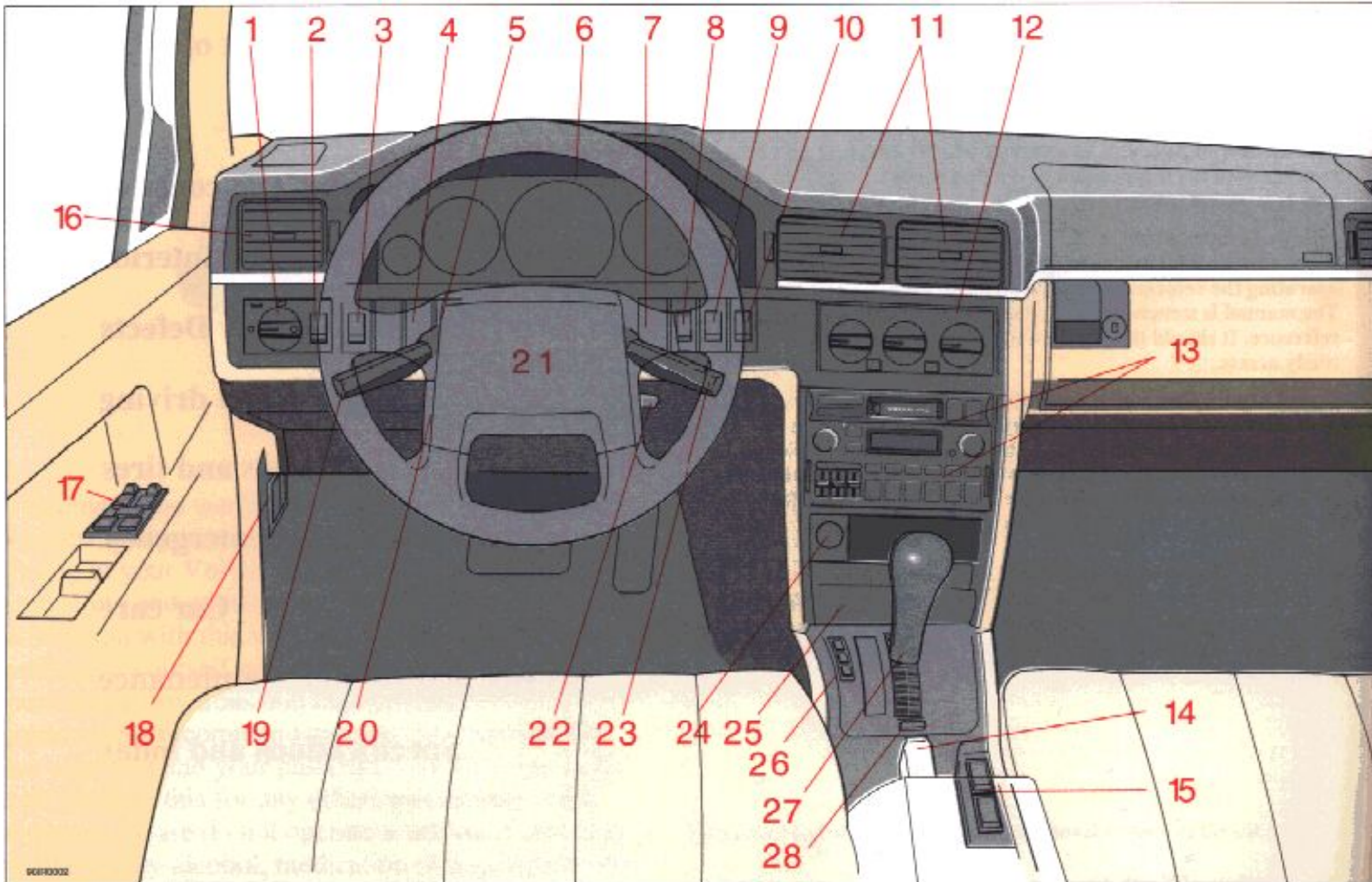

pg. 1:1 Instruments, switches and controls

IMPORTANT!

Your car is equipped with a Shiftlock-Keylock system.

SHIFTLOCK:

When your car is parked, the gear selector is locked in the (P)ark position. To release the selector from this position, turn the ignition key to position II (or start the engine), depress the brake pedal, press the button on the front side of the gear selector and move the selector from (P)ark.

If it is necessary to manually override the Shiftlock system, see page 6:19 for instructions.

KEYLOCK

This means that when you switch off the ignition, the gear selector must be in the (P)ark position before the starting (ignition) key can be removed from the ignition switch.

The pages in this section provide detailed descriptions of the vehicle's instruments and controls.

Note that vehicles may be equipped differently, depending on special legal requirements.

[1:6](#) 1 Headlights, Parking lights

- [1:8](#) 2 Instrument panel illumination
- [1:8](#) 3 Front/rear fog lamps
- [1:8](#) 4 Radio antenna
- 5 Space for additional equipment
- [1:1-1:15](#) 6 Instruments
- 7 Space for additional equipment
- [2:6](#) 8 Electrically operated sun roof
- [1:9](#) 9 Hazard warning flashers
- [1:9](#) 10 Heated rear window/side door mirrors
- [1:11](#) 11 Air vents
- [1:11-1:13](#) 12 Heating and ventilation
- [1:17-1:34](#) 13 Audio System
- [1:16](#) 14 Parking brake
- [1:14](#) 15 Electrically-heated front seats
- [1:11](#) 16 Air vent
- [1:15](#) 17 Controls for electrically operated windows
and side door mirrors
- [2:5](#) 18 Hood-release handle
- [2:9](#) 19 Turn signals, high/low beams,
cruise control
- [1:10](#) 20 Adjustable steering wheel
- [1:8](#) 21 SRS/Horn
- [3:4](#) 22 Starting (ignition) switch/steering wheel
lock
- [1:7](#) 23 Windshield wiper/washer
- [1:9](#) rear window wiper/washer (wagons)
- [1:16](#) 24 Cigarette lighter
- [1:16](#) 25 Ash tray
- [4:7](#) 26 Transmission mode selector buttons
- [4:6](#) 27 Gear selector
- [6:19](#) 28 Shiftlock override button

pg. 1:2 Instruments

NOTE: Canadian model speedometers/odometers indicate kilometers only.

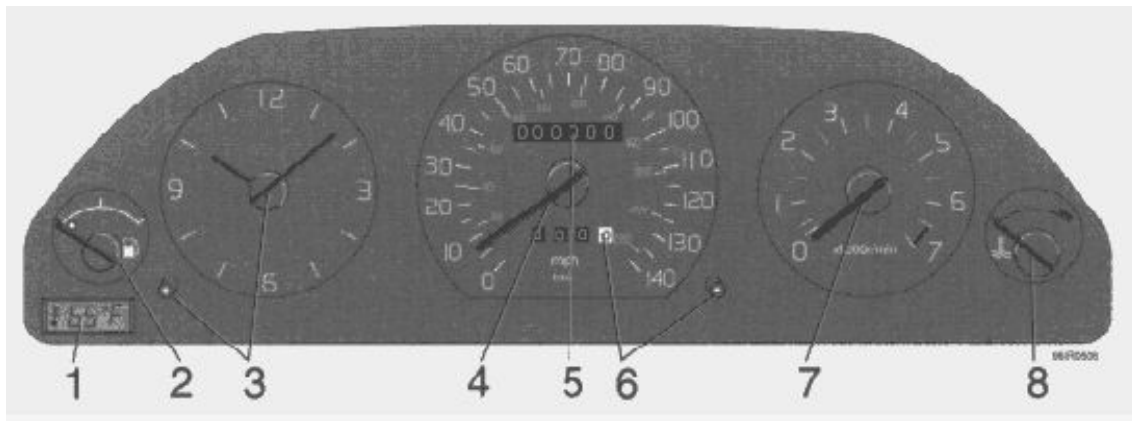

1 Ambient temperature sensor (dealer-installed option)

Indicates the temperature slightly above the surface of the road. A red warning lamp lights up when the temperature is in the range of 23-36° F (-5 - +2° C). At low speeds or when the car is not moving, the temperature readings may be slightly higher than the actual ambient temperature due to heat generated by the engine.

2 Fuel gauge

The fuel tank capacity is approx. 21.1 US gals (80 liters) for sedans and 19.8 US gals (75 liters) for wagons. When the warning light comes on, there are approx. 1.6 US gals. (6 liters) of fuel remaining in the tank. See "Refueling" for further information.

3 Quartz crystal clock/clock set button

Press the button and turn to set the clock.

4 Speedometer

5 Odometer

6 Trip odometer/reset button

Used for measuring shorter distances. The last digit indicates 1/10 mile/kilometer. A black number on a white background = original speedometer. A red number on a white background = replacement speedometer.

7 Tachometer

Reads thousands of engine rpm. Engine should not be operated in red range.

8 Temperature gauge

The pointer should be approximately midway on the gauge face when driving. If the pointer approaches the red range repeatedly, check coolant level and fan belt tension. Do not drive the car with the pointer in the red range. See sections "Coolant" and "Drive belts".

Warning! Allow engine to cool before adding coolant.



- 1 Turn signal, left
- 2 Turn signal, right
- 3 Malfunction indicator lamp
- 4 Direction indicator, trailer
- 5 Service reminder indicator
- 6 Low washer fluid level.
If the lamp glows continuously when the engine is running, there is only about 1/2 - 1 US qts. remaining in the washer fluid reservoir.
- 7 Rear fog lamp
- 8 Bulb failure
- 9 Generator not charging
- 10 Low engine oil pressure
- 11 High beams
- 12 Brake failure
- 13 Parking brake applied
- 14 ABS-system
- 15 Low coolant level
- 16 (Not in use)
- 17 "Winter" mode engaged/transmission fault
- 18 Fasten seat belts
- 19 SRS
- 20 (Not in use)
- 21 (Not in use)

pg. 1:4 Warning lights

The warning lights described on pages 1:4 and 1:5 should never stay on when driving

When the ignition key is turned on, and before the engine starts, all of the warning lights should be on to test the function of the bulbs. Should a light not go off after the engine has started, the system indicated should be inspected. However, the parking brake reminder light will not go off until the parking brake is fully released.



Generator warning light

If the light comes on while the engine is running, check the tension of the generator drive belt as soon as possible.

NOTE: This warning light is illuminated if the generator is not charging. However, parking brake, brake failure and bulb failure warning lights will be illuminated at the same time due to the design of the system.



Malfunction indicator lamp

If this lamp comes on (or stays on after the vehicle has started), the engine diagnostic system has detected a possible fault in the emission controls. Although driveability may not be affected, see an authorized Volvo dealer as soon as possible for inspection.



Oil pressure warning light

If the light comes on while driving, the oil pressure is too low. Stop the car and then stop the engine immediately and check the engine oil level. See the section titled "Engine oil". If the light stays on after restart, have the car towed to the nearest authorized Volvo dealer. After hard driving, the light may come on occasionally when the engine is idling. This is normal, provided it goes off when the engine speed is increased.



Parking brake reminder light

This light will be on when the parking brake (hand brake) is applied. The parking brake lever is situated between the front seats.

Canadian models are equipped with this warning light: 



Brake fluid warning light

If the light comes on while driving or braking, this indicates that the brake fluid level is too low.

Stop immediately, open the hood and check the brake fluid level in the reservoir (see section "Engine compartment" for reservoir position)!

Canadian models are equipped with this warning light: 

Warning!
If the fluid level is below the MIN mark in either section of the reservoir: **DO NOT DRIVE.** Tow the car to a Volvo dealer and have the brake system checked and any leakage repaired.

pg. 1:5 Warning lights (cont.)



Anti-lock Brake System (ABS)

If the warning lamp lights up there is a malfunction of the ABS system (the standard braking system will however function). The vehicle should be driven to a Volvo dealer for inspection.

See page 4:15 for additional information.

Canadian models are equipped with this warning light: 



Mode "W" engaged

The lamp will light up when the Winter starting mode is engaged. If the warning lamp begins to flash, this means that there is a fault in the automatic gearbox. Contact your Volvo dealer.



Supplemental Restraint System (SRS)

If the light comes on (or stays on after the vehicle has started), the SRS diagnostic system has detected a fault. Drive to an authorized Volvo dealer for an inspection of the system. See the SRS section for more information.



Service reminder indicator

This light will come on at 10,000 mile (16,000 km) intervals. It is a reminder to the driver that the 10,000 mile (16,000km) service interval has been exceeded. The light will stay on 2 minutes after start until reset by the servicing dealer.



Coolant level sensor

If this light comes on while driving, the coolant level is low. The coolant level in the expansion tank should be checked immediately and topped up if necessary. The cooling system should be inspected by an authorized Volvo dealer.

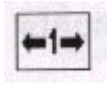

Turn signal indicators-trailer (certain models)

When towing a trailer, this light will flash simultaneously with the turn signals on the trailer. If the light does not flash when signaling, neither the trailer's turn signals nor the car's turn signals are functioning.



Bulb failure warning light

The light will come on if any of the following bulbs are defective:

- one of the low beam headlights
- one of the tail lights
- one of the brake lights when the brake pedal is depressed.

Check the fuse and bulb. See sections titled "Replacing bulbs" and "Fuses".

Should the warning light come on after a defective outside bulb has been replaced, the corresponding bulb on the other side of the car should also be replaced.



[Contents](#) | [Top of Page](#)

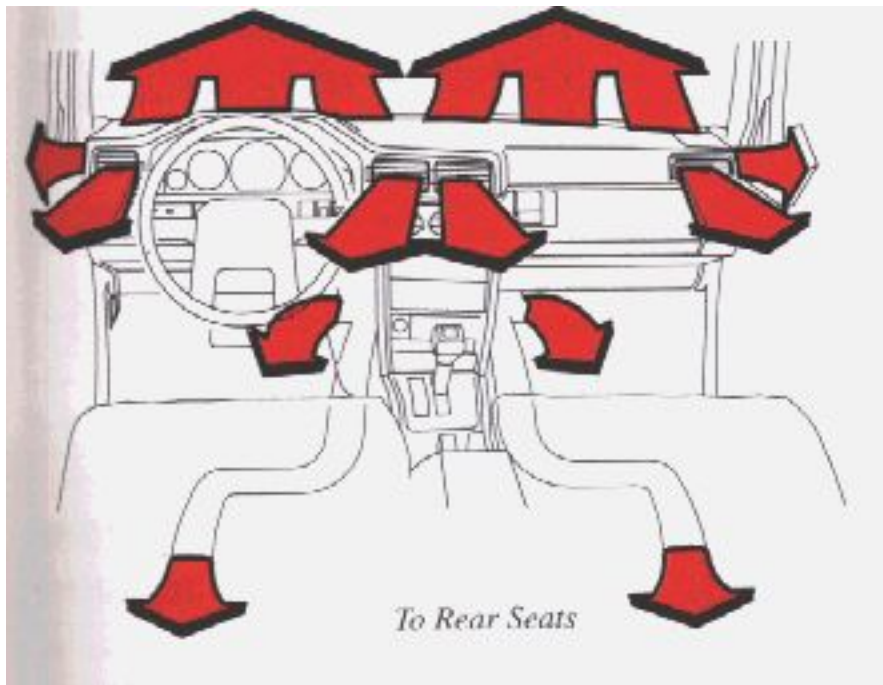

ECC - Electronic Climate Control

This is an automatic system that also permits manual operation. The in-car temperature is automatically monitored by two sensors located in the passenger compartment.

One sensor is located on the top of the dashboard where it can sense sunlight. The second sensor is located on the courtesy light fixture where it can sense the temperature in the center of the car. The following pages describe how ECC works and how it can be used most effectively.

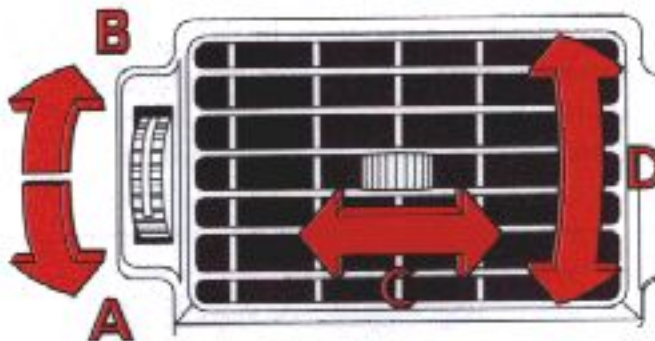



Air vents (dash)

A Open

- B Closed
- C Directing air flow horizontally
- D Directing air flow vertically

pg. 1:12 Heating, ventilation and air conditioning (cont.)

ECC - Electronic Climate Control panel

<p>Blower 0=off 5 = max speed aut = blower speed automatically regulated</p>	<p>Function selector Set desired function aut = normal setting</p>	<p>Temperature dial Set desired temperature</p>
 <p>Air in the passenger compartment recirculates with this button depressed. Will not function in defrost setting. Light is on when function is engaged*</p>	 <p>The air conditioning system is disengaged when this button is depressed (the light will be on). The light has two functions:</p> <ul style="list-style-type: none"> • air conditioning disengaged * • fault in system 	

* When the function selector is in the  mode, the air conditioning system is ON and recirculation is OFF, regardless of button position. The light surrounding the "AC OFF" button will be OFF and the light surrounding the recirculation button will be OFF.

Function selector

aut aut = air distribution automatically regulated



Air through panel vents



Defrost. Air to windshield and side windows.



Air to floor, windshield and side windows.



Air through floor vents.



Bi-level. Air through floor and panel vents. Air supplied from panel vents is slightly colder than air released at foot level.

pg. 1:13 Heating, ventilation and air conditioning

Automatic setting

The ECC system will automatically maintain a comfortable in-car temperature regardless of the outdoor temperature.

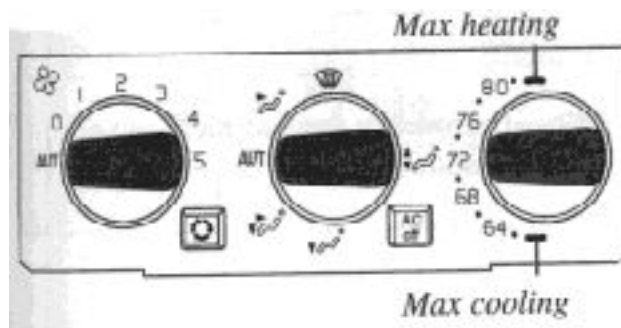

Select the desired temperature

The blower will run at its maximum speed in either the max cooling or max heating positions.

Water under the vehicle in hot weather can be the result of condensation from the air conditioning system.

Optimum defrosting



Set the function dial to .

The air conditioning light will NOT go on. When the windows have cleared, set the blower control to position 2.

NOTE: The air conditioning compressor only engages at temperatures above 45° F (7° C).

Always keep the air intake grille at the base of the windshield free of snow.

The air conditioning system in your car contains a CFC-free refrigerant - R134a. This is an environmentally friendly substance having minimal effect on the earth's ozone layer. The system contains 2 lbs (0.9 kg) R134a.

Operating Tips

When the outside air is contaminated with exhaust gases, smoke etc. (as when driving through a tunnel)



or to heat/cool the car quickly, push the recirculation button . In this position, very little air is drawn into the passenger compartment from outside. However, do not leave the system in this mode for more than 10-15 minutes, since the air inside the car will become stale and the windows may fog.

NOTE: Do not place any objects over the sensor in the passenger side speaker grille as this will cause the ECC system to respond incorrectly to ambient conditions.



ECC system fault indication

If the light in the air conditioning push button begins to flash when the ignition is switched on, a simple fault is indicated. The system will compensate by substituting a standard value stored in the memory. System performance loss will be slight.

If the light continues to flash more than 20 seconds, a more serious fault is indicated. While the system will again attempt to substitute a standard value, some reduction in system performance will become apparent. Contact your authorized Volvo dealer for service.

pg. 1:14 Heated front seats

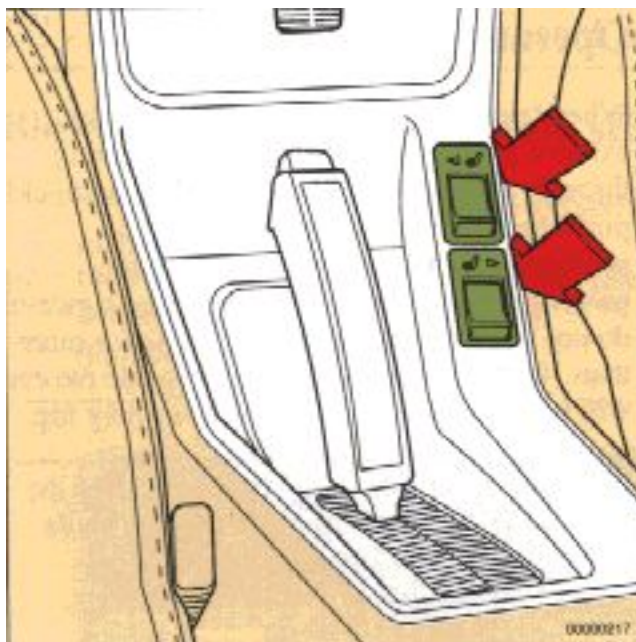

Heated front seats

The heated front seats can be switched on and off as required. When switched on, the system senses the ambient temperature and regulates the level of heat applied. When the optimum temperature is reached, the heating is switched off automatically.

While driving, the passenger seat heating should be switched off when the seat is not occupied.

pg. 1:15 Electrically-operated windows

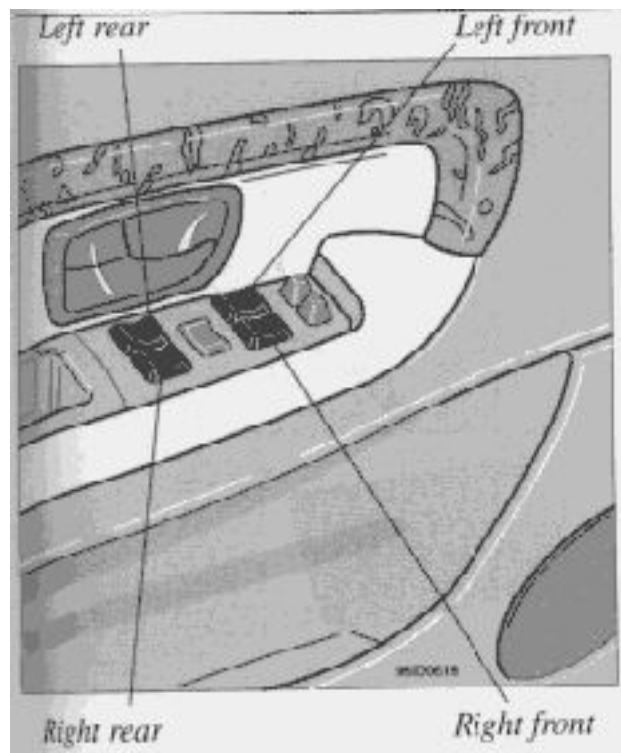

Electrically-operated windows

The electrically operated windows are controlled by switches from the driver's armrest as shown in the above illustration.

The starting (ignition) switch must be ON (position II) for the electrically operated windows to function. The window is lowered if the rear part of the switch is pressed and raised if the front part of the switch is pressed.

WARNING! Remove the starting (ignition) key when children are left unattended in the vehicle.

Make sure that children's hands are clear before raising the windows.

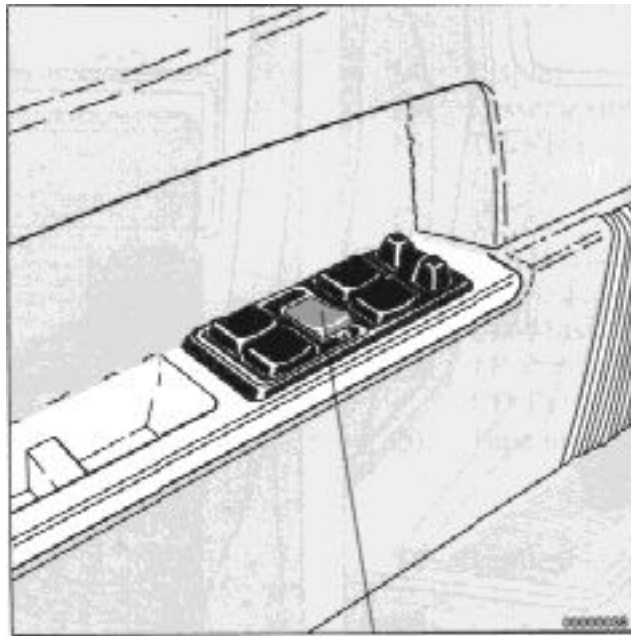

Switch

Cut-out switch for rear-door windows

If the car is equipped with rear door power windows, this function can be disabled by a switch located on the driver's door armrest.

This switch is positioned 90° in relation to the other switches.

- The rear door windows can be raised or lowered with the respective door switch as well as the switch on the driver's door.
- The rear door windows cannot be raised or lowered with the respective door switch but instead only with the corresponding switch on the driver's door.

NOTE: The power window motors have an overload protecting circuit breaker which is activated when an object blocks a window. Should this occur, remove the object and wait 20 seconds for the circuit breaker to reset. The power windows should then function.

pg. 1:16 Parking brake, Cigarette lighter, Ash trays

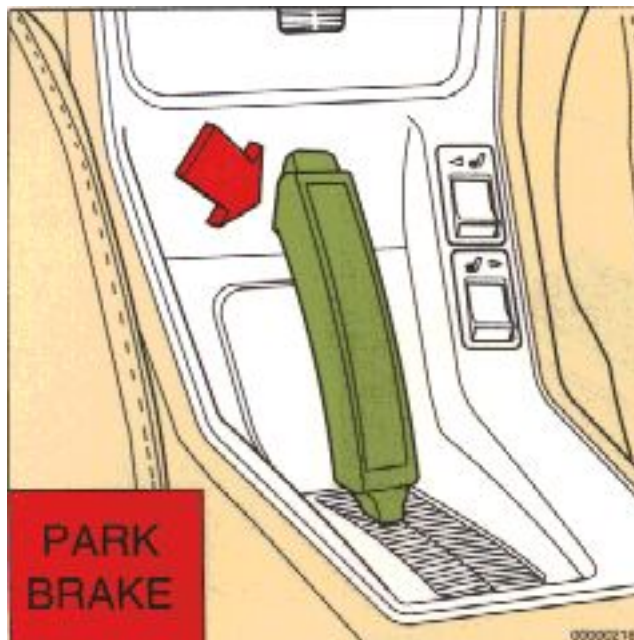

Parking brake (hand brake)

The lever is situated between the front seats. The brake is applied to the rear wheels.

WARNING!

Always use the parking brake (hand brake) when parking. On hills, also turn the front wheels toward the curb.

In order to obtain the best possible performance of the parking brake, the brake linings should be broken in (See section titled "Break-in period").



Lighter

Ash tray

Cigarette lighter

To operate, depress the knob fully. When the knob automatically releases, the cigarette lighter is ready for use.

The starting (ignition) switch must be switched on (to position I or II) for the cigarette lighter to function.

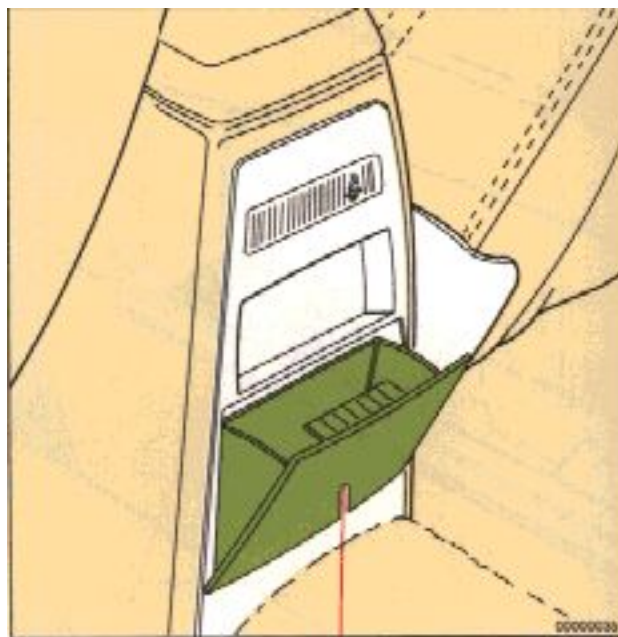

Rear seat ash tray

Ash trays

To remove the ash trays depress the center spring and remove.



[Contents](#) | [Top of Page](#)

The following pages describe the use of your SC-810 Cassette Radio and CD remote control



1. - On/off (turn)
- Volume (turn)
- Pause/Mute (push)
2. CD mode selector
3. Bass control
4. Treble control
5. Fader control
6. Waveband selectors (FM)
7. Waveband selectors (AM)
8. Preset buttons
- CD-Disc No. selector
9. Autostore memory (FM)
10. Autostore memory (AM)
11. - Manual tuning
- Seek tuning (push)
12. Tape direction selector REV

CD-Random play

13. Cassette eject

14. Display

15. Cassette slot

16. TP-Next song

CD-Next track UP

17. TP-Fast forward

CD-Music search UP

18. TP-Rewind

CD-Music search DOWN

19. TP-Previous song REPEAT

CD-Previous track DOWN

20. Tape mode selector

TP = Applicable only in Tape Mode

CD =Applicable only when in CD mode and connected to a CD changer

pg. 1:18 Anti-theft code

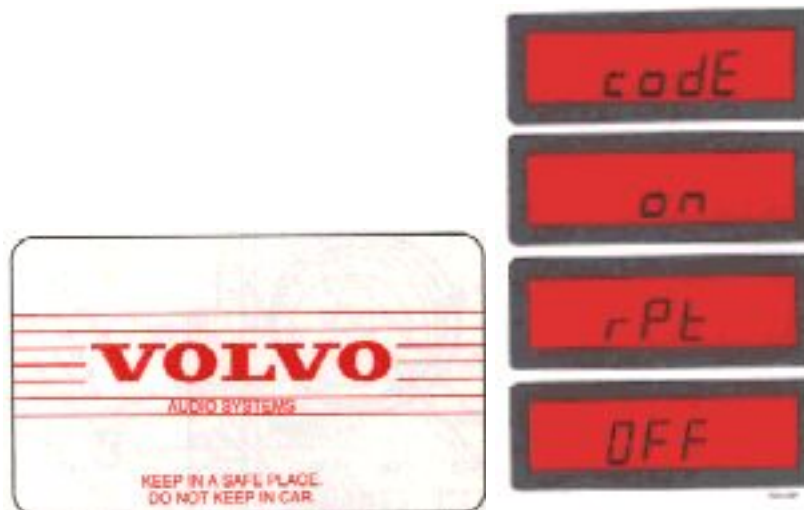



Anti-theft code

The radio features anti-theft circuitry. If the set is removed from the vehicle or if the battery power is disconnected, a special code must be entered to enable operation of the set.

Refer to the radio code card supplied with your vehicle or ask your dealer for the correct code.

To enter the code

After installation or when the set has been disconnected from power, the set displays "codE" when it is switched on.

Enter the 4-digit code using the preset buttons. If the correct code is entered, "on" is displayed and the set is ready to use.

If you enter an incorrect code you must enter the correct code again from the beginning.

Incorrect code

If an incorrect code has been entered "rPt" is displayed. Enter the correct code.

After three unsuccessful coding attempts the set will lock and remain locked for two hours.

"OFF" is displayed.

After two hours have elapsed, re-enter the correct code.

NOTE: During the two hour waiting period, the set must be connected and turned on.



A - On/off switch and volume control

Turn the button clockwise to switch on and to increase the volume.

B - Waveband selector

The desired waveband is set by pressing one of the waveband selector buttons. The frequency and waveband is shown on the display.

NOTE: There are two FM wavebands and two AM wavebands. This makes it possible to store 2 x 6 FM stations and 2 x 6 AM stations in memory.

C - Manual tuning

Turn the knob counter-clockwise to tune to lower frequencies and clockwise to tune to higher frequencies. The tuned frequency is displayed.



A - Seek tuning

Push the tuning knob to seek for higher frequencies. The radio seeks the next audible station and stops there. If you wish to continue the seek tuning, press the tuning knob again.

B - Preset programming

1. Tune to the desired frequency.
2. Depress and hold a preset button. The audio will cut out. Keep the button depressed until the audio comes on again (approx. 2 seconds).
3. The frequency is now stored on this preset button.

C - Preset buttons

To select a pre-programmed radio frequency, depress the preset button. The set frequency will be displayed.



A - Automatic programming (Autostore)

This function automatically seeks and stores up to 8 strong AM or FM stations.

1. Depress and hold one of the "auto store" buttons for at least 1 second. A number of strong stations (max. 8) on the chosen waveband are now automatically stored in the memory. The lowest frequency station is heard. If there are no audible stations, "no" is displayed.
2. Press one of the "auto store" buttons (for less than 1 second) to obtain another autostored station. A new station will be selected each time one of these buttons is pressed.

B - Bass control

Adjust the bass by sliding the control up or down (up to increase, down to decrease). A "detent" indicates "equalized" bass.

C - Treble control

Adjust the treble by sliding the control up or down (up to increase, down to decrease). A "detent" indicates "equalized" treble.

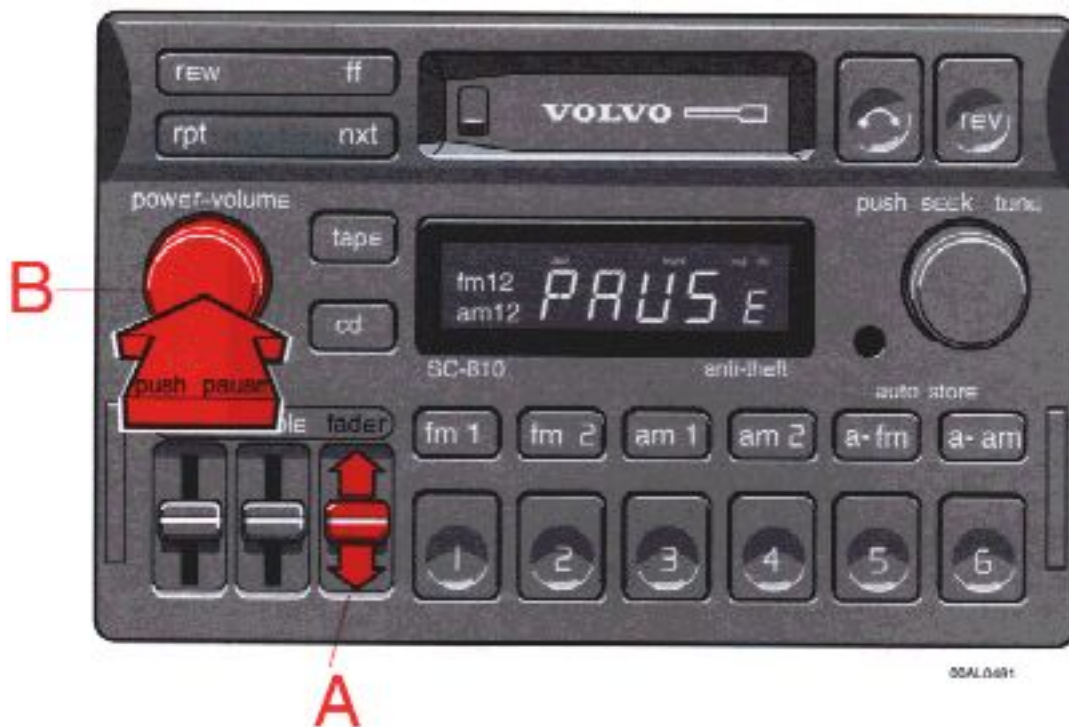

A - Fader control

Adjust front/rear speaker balance by sliding the control up or down.

(Up to direct more sound to the front speakers, down to direct more sound to the rear speakers.

The "detent" indicates "equalized" front /rear balance position.

B - Mute function

Press the "power-volume" knob to temporarily mute the sound. "PAUSE" is displayed.



[Contents](#) | [Top of Page](#)



A - Cassette slot

The cassette is inserted with the open side to the right (side 1 or A of the cassette upwards). When the cassette is inserted, the radio is disengaged and the cassette will start to play automatically. "TAPE 1" or "TAPE 2" is displayed to indicate which side of the tape is being played. When one side of the tape has been played the unit will automatically play the other side (auto-reverse). The cassette can be inserted or ejected even when the unit is switched off.

B - Reversing the tape (rev)

Press the button to play the other side of the tape.
The side of the tape being played will be displayed.

C - Fast winding

The tape is advanced with "95" and rewound with "rew". The tape side indicator in the display will flash rapidly during fast winding. Fast winding can be stopped by pressing the button again.



A - "nxt" (next) selector

Press the "nxt" button and the tape will automatically advance to the next song. There must be a pause of approx. 5 seconds between songs for this function to operate.

B - "rpt" (repeat) selector

Press the "rpt" button to rewind the tape to the beginning of the song. Press the button again to rewind to the beginning of the previous song.

There must be a pause of approx. 5 seconds between songs for this function to operate.

C - Pause

If you press the "power-volume" knob the tape is stopped, the unit is silent and "PAUSE" is displayed. To restart the tape press the knob again.



A - Cassette eject

If the button is pressed the tape will stop and the cassette will be ejected. The radio will be automatically engaged. The radio or CD will engage automatically (depending on which mode was activated before the tape was played).

B - To re-enter Radio mode

There are three alternative ways to re-enter Radio mode:

- Push one of the waveband selector buttons
- Push either of the autostore buttons
- Push one of the preset buttons

When the unit re-enters Radio mode, the cassette will not be ejected.

C - To re-enter Tape mode

If the Tape function has been disconnected and the cassette has not been ejected, the Tape mode can be re-entered by pressing the "tape" button.

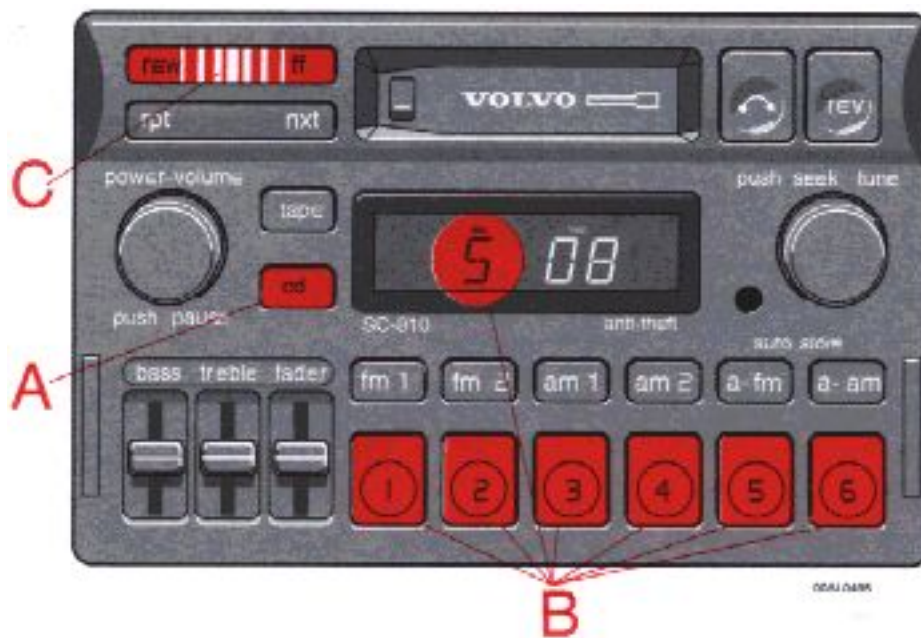

A - CD mode selector

Press "cd" to actuate the CD mode. The disc/track last listened to will continue to play. If the CD-changer cartridge* is empty, "---" will be displayed.

If a selected disc does not exist, the disc number and "5--" will be displayed and the next disc will be automatically selected.

* The functions pertaining to the CD-changer are only applicable if the unit has been connected to the Volvo CD-changer which is sold separately as an accessory.

B - Disc number selector

Depress one of the preset buttons (1-6) to select the disc number desired. The selected disc number and track number will be displayed.

C - Music search

Press the "rew" or "ff" button to search within a track. While the button is depressed the playing time for this track will be displayed.

pg. 1:27 CD remote (accessory) (cont.)



A - Track number selector

Turn the knob to select the track number desired.

B - Changing the selected track number

Press "nxt" for forward selection or "rpt" for backward selection. The chosen disc number and track number will be displayed.

C - Playing-time display

When this button is pressed the playing time for the current track is displayed for 5 seconds.

pg. 1:28 CD remote (accessory) (cont.)



A - Random choice

Press "rev" to actuate the random mode. From a disc chosen at random, 4 tracks will be played (also chosen at random). A new disc will then be played in the same way. "RND" will be displayed when this function is engaged.

B - Pause

If you press the "power-volume" knob the disc is stopped, the unit is silent and "PAUSE" is displayed. To restart the disc press the knob again.

C - To re-enter Radio mode

There are two ways to re-enter Radio mode:

- Push one of the waveband selector buttons
- Push either of the autostore buttons

D - To re-enter Tape mode

If a cassette is already inserted, the tape deck will re-engage if the "tape" button is pressed.

pg. 1:29 CD remote (accessory) (cont.)

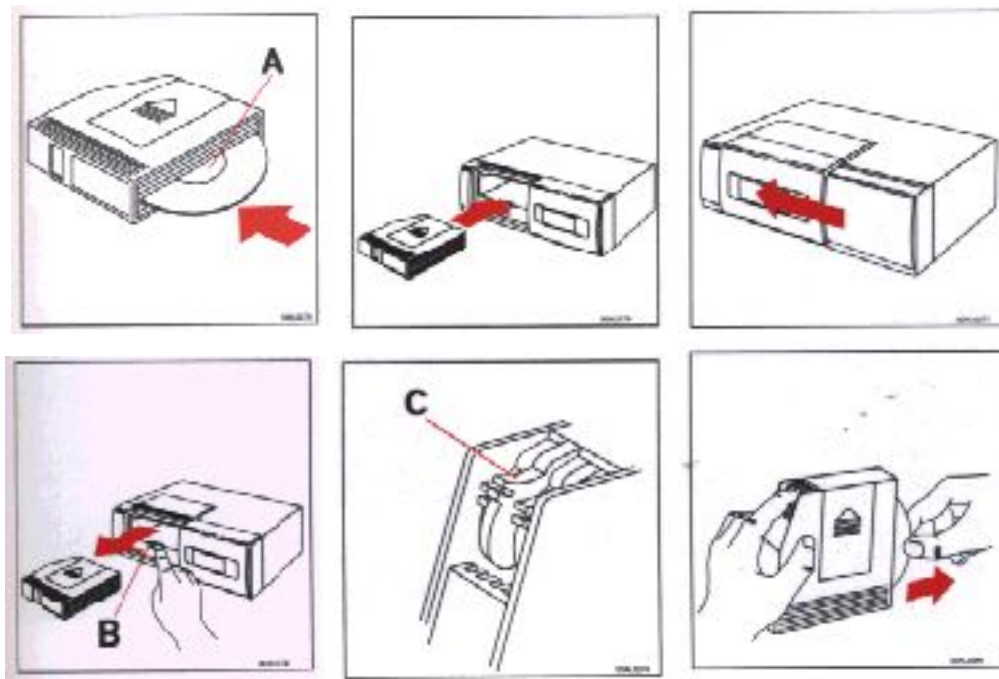

CD changer

The CD changer, which is available separately, is loaded with a cartridge containing 6 discs. Extra cartridges are available at your Volvo dealer.

Insert the discs into the cartridge, label (A) up.

Insert the cartridge and close the cover.

Eject the cartridge by pressing the eject button (B).
Remove the discs by depressing the lock tabs (C).

Operating tips:

- Before using a new disc for the first time, remove any burrs in the center/outer edge by running the stem of a pen or similar object around the hole/edge of the disc.
- Use high quality discs only.
- Keep the discs clean. Wipe them with a soft, clean, lint-free cloth, working from the center outwards. If necessary, dampen the cloth with a neutral soap solution. Dry thoroughly before using.
- Never use cleaning spray or anti-static liquid. Use only cleaners specifically made for CD's.
- Use discs of the correct size only (3.5" discs should never be used).
- Do not put tape or labels on the disc itself.
- Condensation may occur on discs/optical components of the changer in cold winter weather. The disc can be dried with a clean, lint-free cloth. Optical components in the CD changer may, however, take up to one hour to dry off
- Never attempt to play a disc which is damaged in any way.
- When not in use, the discs should be stored in their covers. Avoid storing discs in excessive heat, direct sunlight or dusty locations.



[Contents](#) | [Top of Page](#)

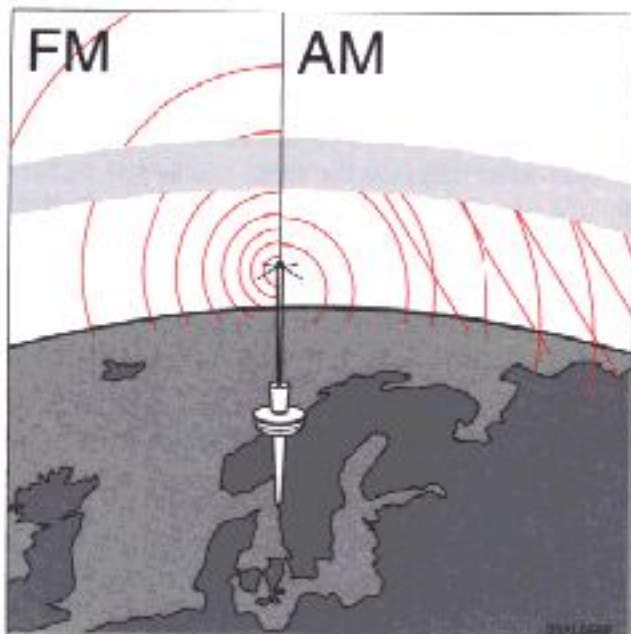

Sending signals

The FM waves do not follow the earth's surface nor do they bounce off the atmosphere. For this reason their range is limited. The AM waves follow the earth's surface and reflect against the atmosphere, giving them a wide range.

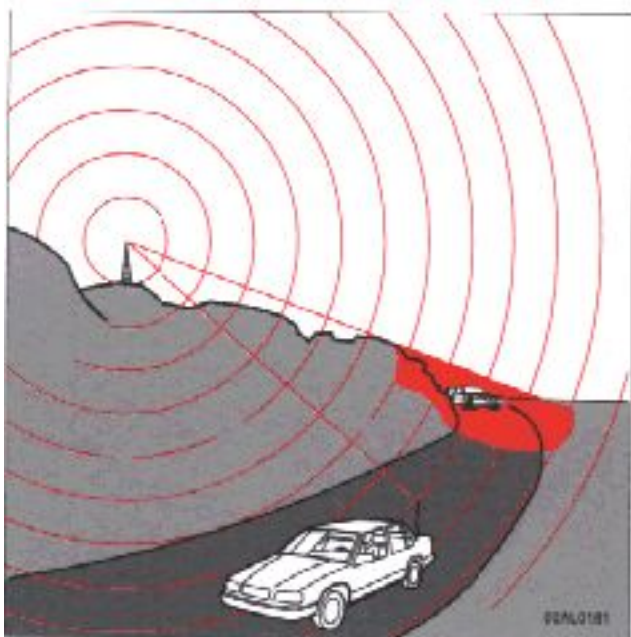

Weak reception (fading)

Because of the limited range of the FM senders and the fact that these waves are very reflective, this problem usually occurs with FM reception. If the sender is blocked by buildings or mountains, static can result.

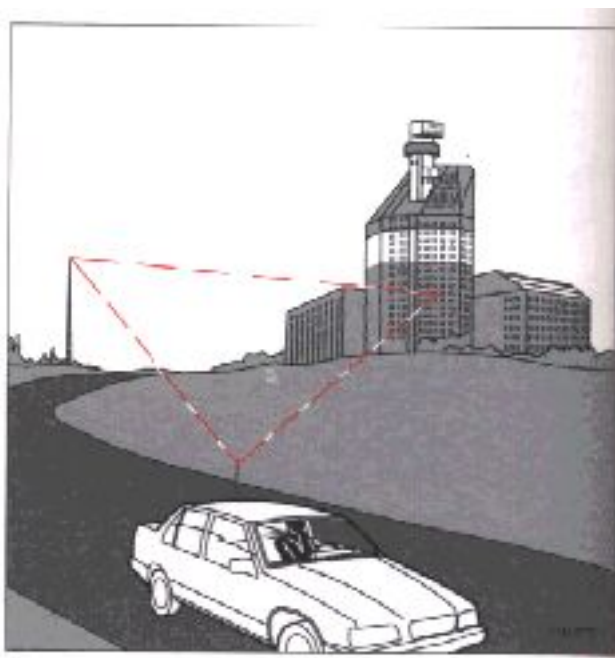

Static

The reason why FM but not AM is audible in covered parking areas, under bridges, etc, is that FM signals reflect against solid objects such as buildings. Because these waves are very reflective, static can result. This static is the result of the reflected signal and the direct signal reaching your antenna at slightly different times causing a cancellation of all signals. This problem occurs largely in built-up areas. To help minimize this situation, turn down the treble and turn off loudness.

pg. 1:31 Cross modulation, FM-reasons for distortion, AM-reasons for distortion

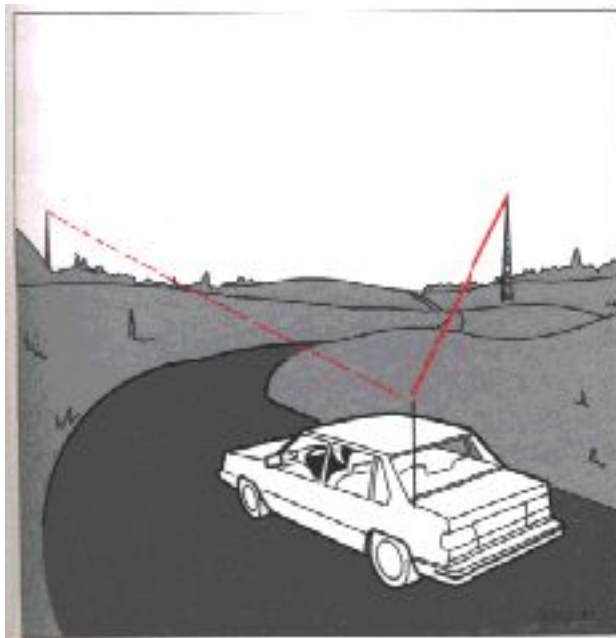

Cross modulation

If you listen to a weak station in the vicinity of a stronger one, both stations may be received simultaneously.

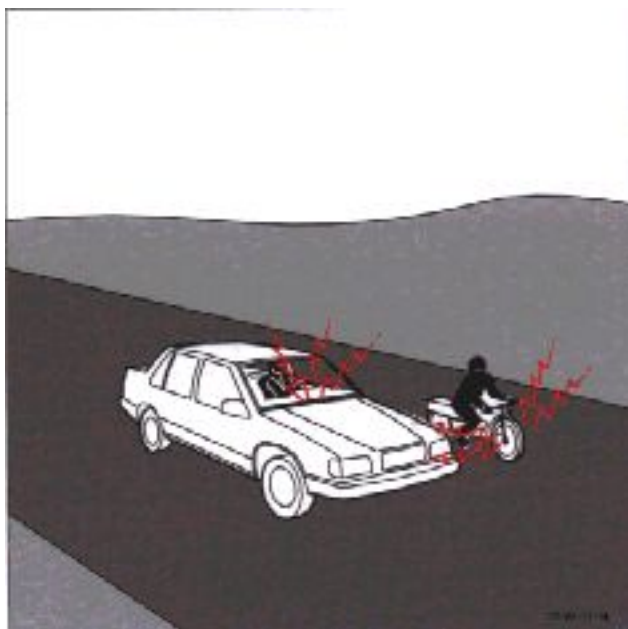

FM - reasons for distortion

FM is affected by the electrical systems of nearby vehicles, especially those without suppression. The distortion increases if the station is weak or poorly set.

The FM reception is not as sensitive to electrical disturbance as AM.



AM - reasons for distortion

AM reception is sensitive to electrical disturbances such as power lines, lightning, etc.

pg. 1:32 Radio

FM stereo reception

Stereo reception places very high demands on the signal quality which means the type of distortions previously mentioned become even more obvious. The signal strength needs to be stronger for good stereo reception and this limits the effective range of the sender.

We hope that this information proves to be useful and provides you with a better understanding of the problems related to car radio reception.

Reception conditions are not always optimum and this is, of course, beyond our control. However, we have endeavored to make the Volvo Audio System of a quality that will enable you to enjoy the best possible reception no matter what the reception conditions may be.

Radio antenna

NOTE: Always lower the antenna when using an automatic car wash or entering a garage. The antenna should be cleaned at least every 10,000 miles (16,000 km) or more frequently if needed. Use WD40 for cleaning.

Spray the antenna with WD40 and wipe it clean and dry with a rag. Spray it again. Lower and raise the antenna. Wipe it clean and dry again. Lower and raise the antenna 4-6 times. Make sure it is dry and free from dirt or lubricating oil.

Cassettes

- Store cassettes in their cases.
- Do not touch the tape surface with your fingers.
- Tapes should not be exposed to direct sunlight or extreme temperatures.
- Keep tapes away from oil, grease and other contaminants.
- For optimal tape deck performance Volvo does not recommend the use of C- 120 tapes.
- Take up slack using a pen or a pencil before inserting a cassette in the cassette slot.

Cassette cleaning

We recommend the use of the Volvo Cleaning Cassette available as a genuine Volvo accessory. Regular use improves sound quality, cleans vital parts and prevents tape tangle.

pg. 1:33 Technical specifications

Technical specifications

Output: 4 x 20 W (10% dist.)

Output impedance: 4 Ohms

System voltage: 12 Volts, negative ground

Fuse: 5 A

Radio

System: superheterodyne system with HF-step.

Electronic suppression device

Frequency range:

SC - 810 FM 87.9 -107.9 MHz

AM 530 - 1710 kHz

Sensitivity: FM 1.1 V

AM 20 V

Stereo separation: 35 dB

Cassette deck 4-track, 2 channel stereo

Tape speed: 4.76 cm/sec.

Channel separation 48 dB

Frequency range 30-15000 hz

S/N (120 V) 55 dB

S/N (70 V) 55 dB

Wow and Flutter 0.13%



[Contents](#) | [Top of Page](#)



pg. 1:6 Lighting, Turn signals

Headlights and parking lights

O All lights off *

 Parking lights on *

 Headlights and parking lights are on if starting (ignition) switch is in position I or II.

If the headlight switch is in position  all lights will go out when starting switch is switched off.
With the headlight switch in position  the parking lights will stay on.

The high beams can only be switched on if the headlight switch is in position .
Switch from high to low beams, and vice versa, by moving the turn signal switch lever on the left side of the steering column towards the steering wheel.

* Canada models equipped with Daytime Running lights

The low beams will come on automatically when the engine is started.

Turn signals

1 Lane change position. In maneuvers such as lane changing, the driver can flash the turn signals by moving the turn signal lever to the first stop and holding it there. The lever will return to the neutral position when released.

2 Signal lever engaged for normal turns.

NOTE: Defective turn signal bulb will cause turn signal indicator and remaining signal lights to flash more rapidly than normal.

3 High beam/low beam switch (headlights on).

Move the lever towards the steering wheel and release it.

3 Headlight flasher (headlights off).

Move the lever towards the steering wheel.

The headlight high beam will be on until the lever is released.

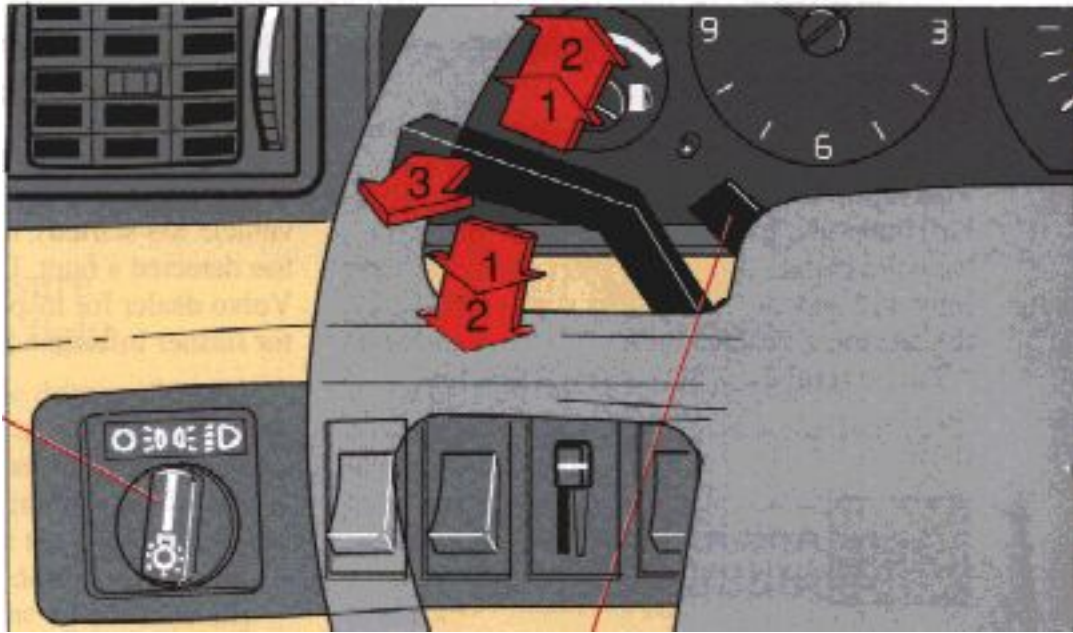

pg. 1:7 Windshield, wipers/washer, Ignition switch

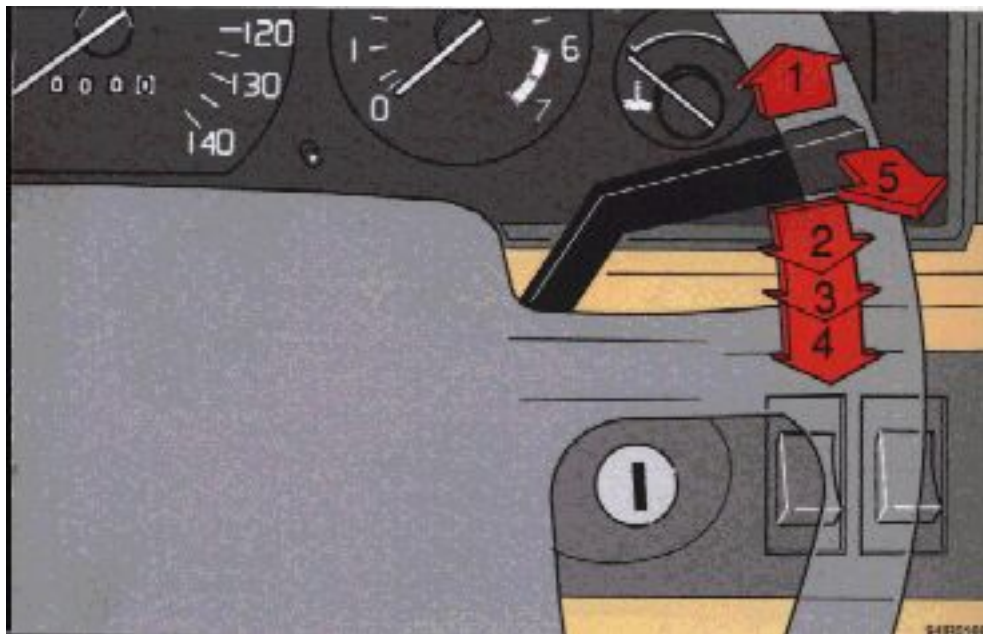

Wiper/washer

1 Intermittent wiper.

With switch in this position, the wipers will sweep approximately every seventh second.

2 "Single sweep" position.

Switch returns automatically when released.

3 Wipers, low speed.

4 Wipers, high speed.

5 Windshield wiper/washer.

The wiper will make 2-3 complete sweeps after the lever is released.

Starting (ignition) switch/steering wheel lock

The steering wheel lock might be under tension when the car is parked. Turn the steering wheel slightly to free the ignition key.

In order to reduce car theft, make sure the steering wheel lock is engaged before leaving the car.

A chime will sound if the starting key is left in the ignition lock and the front door on the driver's side is opened.



O Locked position:

remove the key to lock the steering wheel. *



I Intermediate position:

Certain accessories, etc. on.



II Drive position:

key position when engine is running.



III Starting position:

release the key when the engine starts. The key returns automatically to driving position.

Warning:

Never turn the key to position O while driving or when the car is being towed.

* The gear selector must be in the (P)ark position before the key can be removed from the ignition switch.

pg. 1:8 Fog lights, Instrument illumination, Power antenna

Front and rear foglights

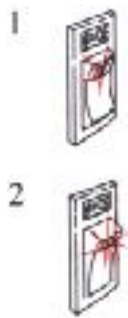

The switch has two settings:

- 1 Front foglights ON.
- 2 Front and rear foglights ON.

When both front and rear foglights are turned on both indicators will light.

The rear foglight is considerably brighter than the normal tail light and should be used only when the atmospheric conditions, such as fog, rain, snow, smoke or dust reduce the daytime or nighttime visibility of other vehicles to less than 500 ft (150 meters).

The lowbeam headlights must be switched on. Note that local regulations governing the use of these lights may vary.

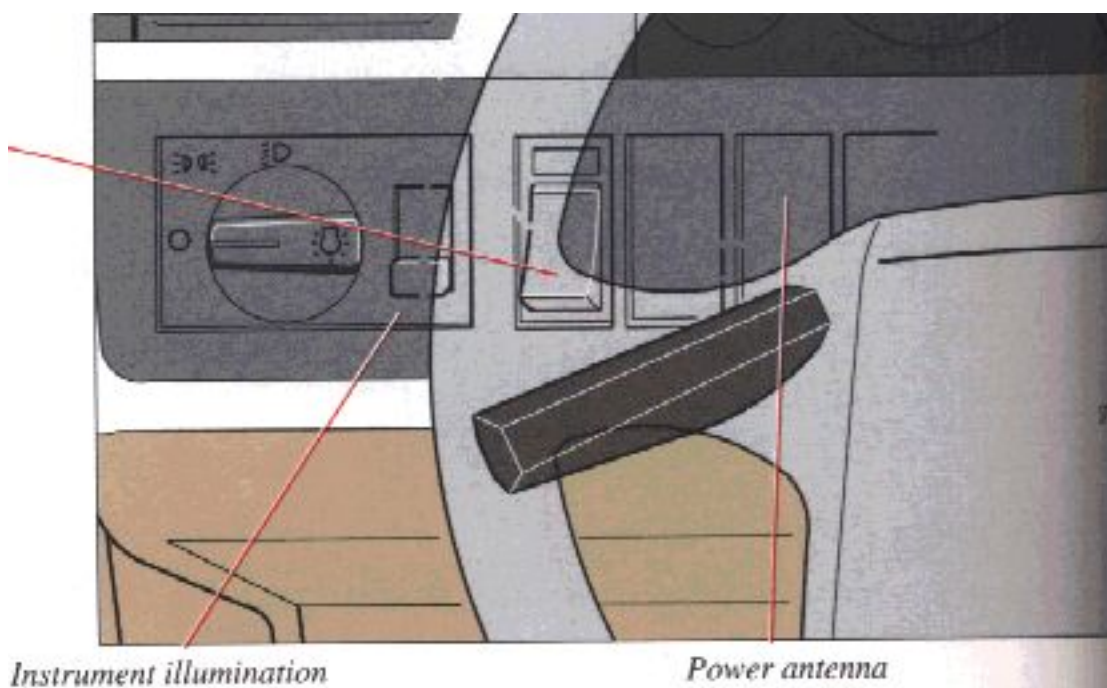

Instrument illumination

To increase the brightness, move the slide switch up.
To decrease the brightness, move the slide switch down.

Power antenna

The power antenna switch can be used to retract the antenna when the audio system is turned on. This will permit operation of the cassette drive with the antenna in the down position.

CAUTION: Always lower the antenna when entering a garage or car wash to avoid antenna damage.

The antenna mast should be cleaned and lubricated every 10,000 miles (16,000 km). See page 1:32.

Steering wheel adjustment

The steering wheel can be adjusted to 3 different positions.

Move the control on the left side of the steering column downward and hold it in place. Adjust the steering wheel to the position desired. Release the control and check that the steering wheel is locked in position.

WARNING! Do not adjust the steering wheel while driving.

pg. 1:9 Sun roof, Hazard warning flasher, Tailgate wiper/washer/demister

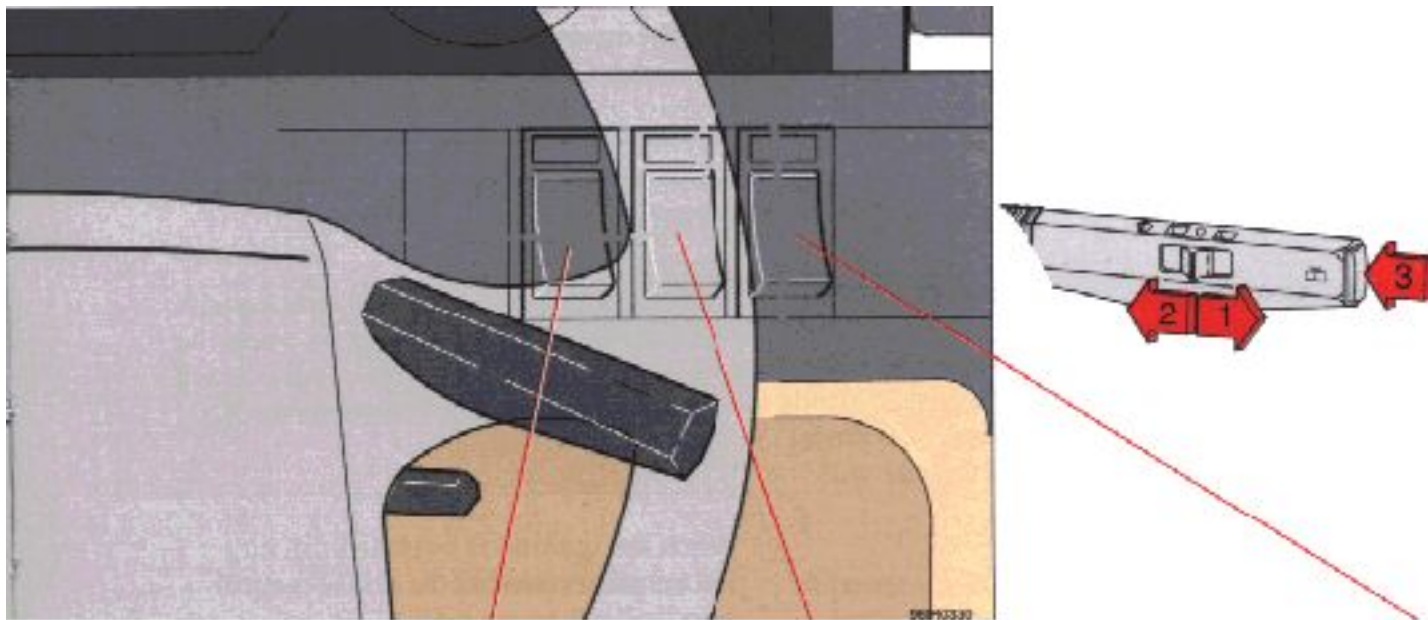

Electrically-operated sun roof

The sun roof can be operated in two ways; as a conventional sliding roof; or the rear edge can be raised to provide increased ventilation. To open the sun roof as a sliding roof, depress the top portion of the switch. To raise the rear edge of the sun roof, depress the bottom portion of the switch. To close the sun

roof, depress the side of the rocker switch opposite the side used to open the roof.

NOTE: In case of a sun roof malfunction, see "Emergency sun roof operation", page 6:19.

Hazard warning flasher

The four-way flasher should be used to indicate that the vehicle has become a traffic hazard.

NOTE: Regulations regarding the use of the hazard warning flasher may vary from state to state.

Tailgate window wiper/washer (wagon)

The tailgate window wiper/washer is operated by a switch at the end of the wiper lever.

1. The wiper operates continuously.
2. Intermittent position: the wiper strokes approximately every 10 seconds.
3. Tailgate washer (note that the wiper also operates when this button is depressed): after the button is released the wiper strokes 2-3 additional times before stopping.

The electrical circuit is protected by fuse 19, located in the central electrical unit. See the section entitled "Fuses".

Rear window demister, heated side-view mirrors

Depress the switch to start heating of rear window and side mirrors. Both orange control lights in the switch will illuminate. A timer switches off the side mirror heating after approx. 6 minutes and the rear window demister after 12 minutes. The control lights go out correspondingly.

CAUTION: Do not place items that may damage the printed circuit against the inner surface of the rear windows.

pg. 1:10 Cruise control

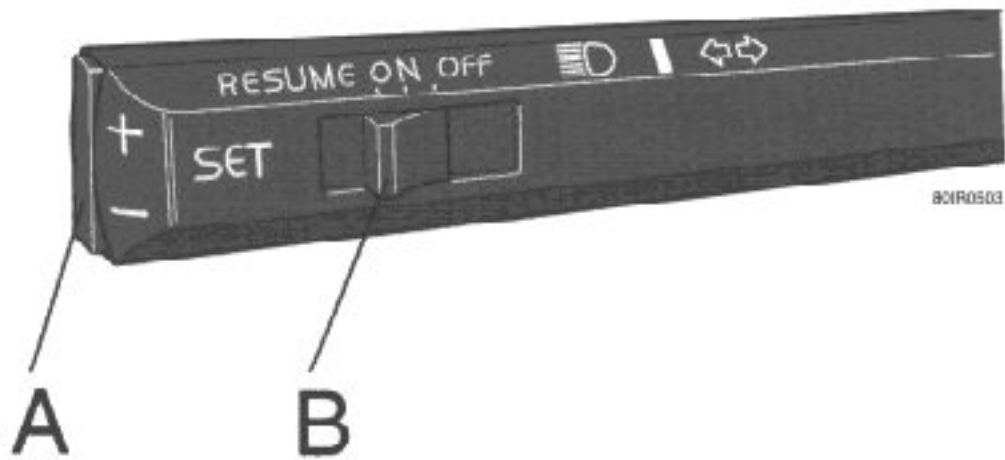

Cruise control

The cruise control switches are located on the turn signal switch lever.

To engage and set desired speed:

1. Set switch (B) to ON.
2. Accelerate to desired cruise speed.

NOTE:

The cruise control cannot be engaged at speeds below 22 mph (35 km).

3. Press the + or - area of the SET button (A) to set the desired speed.

Braking

This will automatically disengage the cruise control. Previously selected cruise speed is retained in the memory and by momentarily setting the switch to RESUME position, that speed will be re-engaged.

If the cruise control is already engaged, the cruising speed can be increased or decreased by depressing the SET button (A) towards either + or - . One short press on the button corresponds to a speed change of approx. 1 mph (1.6 km/h). When the button is released, the vehicle will maintain the current speed.

If actual speed falls below 70% of set speed or if the wheels spin or lock, the cruise control will disengage automatically.

NOTE:

When driving up steep hills with the cruise control engaged, the transmission may shift intermittently. This can be avoided by switching between transmission modes E or S while on the hill. Normally, the (E)conomy mode should be used when the cruise control is engaged.

Acceleration

Momentary acceleration, such as for passing, does not interrupt cruise control operation. The previously selected speed will be maintained without having to set the switch to RESUME.

To disengage the cruise control system:

set switch (B) to OFF, depress the brake pedal or move the gear selector to position N.

Switching off the starting (ignition) switch will automatically disengage the cruise control system.

WARNING!

The cruise control should not be used in heavy traffic or when driving on wet or slippery roads.



[Contents](#) | [Top of Page](#)

Body and interior

pg. 2:1 Body and interior

Body and interior

The seats, seat belts, doors, sun roof, mirrors, etc. are described on the following pages.

[2:2](#) Keys, Doors and Locks

[2:3](#) Remote keyless entry system

[2:4](#) Front seats

[2:5](#) Rear/side view mirrors, Vanity mirror

[2:6](#) Interior light, Rear reading lights

[2:7](#) Child safety locks, Trunk lid

[2:8](#) Passenger compartment storage spaces

[2:9](#) Hood

[2:10](#) Trunk light, spare tire, jack (sedan)

[2:11](#) Station wagon tailgate/child safety lock

[2:12](#) Concealed storage bins, Folding rear seat (wagon)

[2:14](#) Removing seat cushions, Securing cargo (wagon)

[2:15](#) Cargo space lighting, spare tire, jack (wagon)

pg. 2:2 Keys

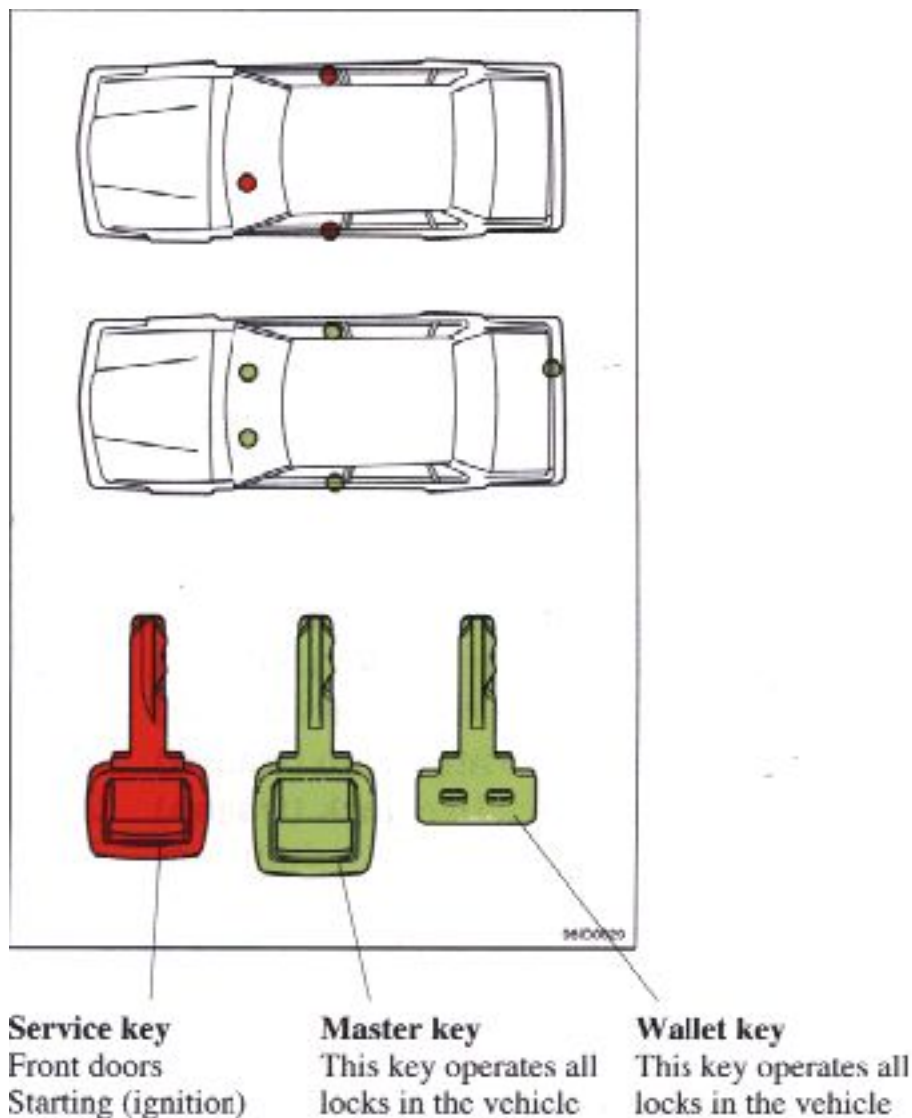

Number tag



The key number codes are stamped on a separate tag supplied with the keys. This tag should be separated from the key ring and kept in a safe place (the back of the tag is coated with adhesive tape).

As an added anti-theft measure, new keys have been developed, which may take slightly longer to copy or replace if the original keys are misplaced.

In the event the original keys are lost, duplicates may be ordered from your Volvo dealer.

The central locking system is described in detail in section "Doors and locks".

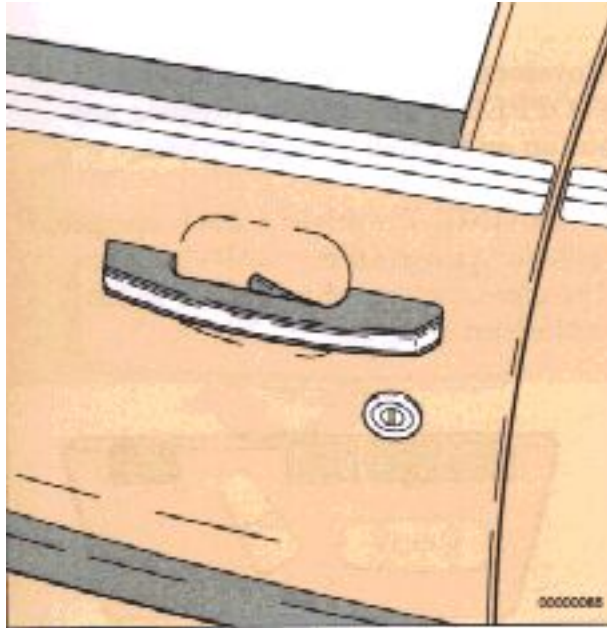

Door Locks

The vehicle is equipped with a central door-locking system. This means the lock on the driver's door controls the locks on the other doors (including the trunk or, on wagon models, the tailgate) automatically.

If the driver's door is locked or unlocked from the outside using the key, the other doors will be locked or unlocked automatically.

WARNING!

The lock buttons should not be in the down position during driving. In case of an accident, this may hinder rapid access to the occupants of the vehicle. (Also see information on "child safety locks".)

To lock/unlock the car by using the lock button on the inside of the driver's door, push/pull to lock/unlock all the doors. Check the action of the buttons on the other doors to verify their correct function (lock/unlock).

The driver's door can be locked only by using the key when outside the vehicle.

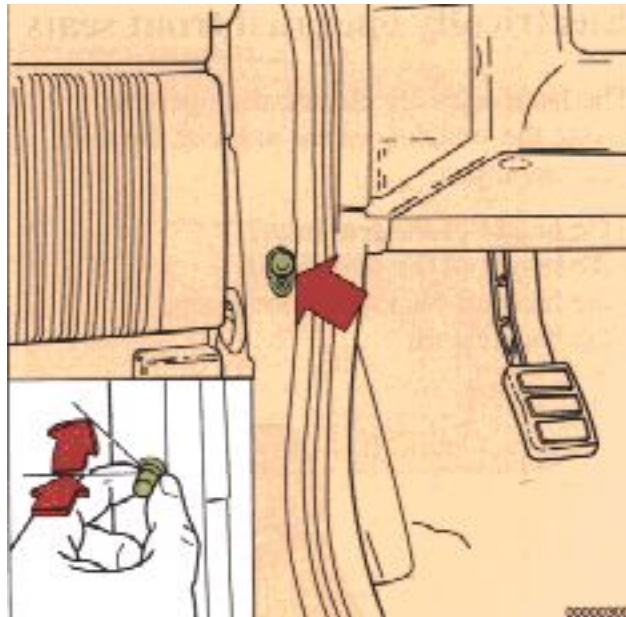

To avoid battery drain

The interior light and the warning lights in the rear of the doors come on when a door is opened. To avoid battery drain when the doors are opened for prolonged periods, these lights can be switched off by pushing in and turning the door light switches slightly clockwise. When the door is closed the switch will return to its normal position.

pg. 2:4 Front seats

Electrically operated front seats

The front seats are electrically operated.

The starting (ignition) key must be in at least position I (certain models) before the seat can be operated.

Using the switches on the sides of the seats you can adjust:

- the height of the seat (rear)
- the height of the seat (front)
- the forward-backward movement
- the backrest tilt



NOTE: The electrically operated front seats have an overload protector which engages if an object blocks either of the seats. If this happens remove the object and wait 20 seconds. The overload protector should then have cooled down and the power seats should function normally.

Passenger's seat

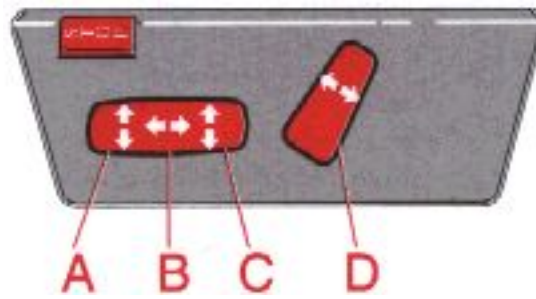

The STOP button (passenger seat only) overrides the other controls. To stop movement of the seat, press and release the STOP button. Press the button again to reactivate the seat controls.

- A Seat front (raise/lower)
- B Forward - rearward
- C Seat rear (raise/lower)
- D Backrest tilt

WARNING! Do not adjust the seat while driving. The seat should be adjusted so that the brake pedal can be depressed fully. In addition, position the seat as far rearward as comfort and control allow. The seat rails on the floor must not be obstructed in any way when the seat is moved.

Driver's seat

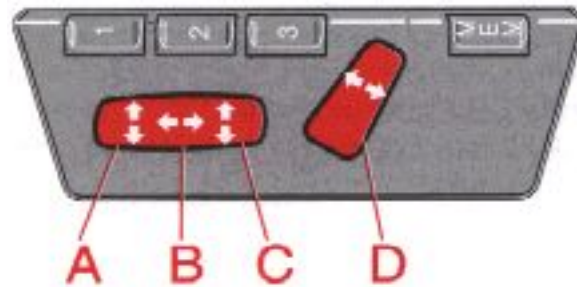

Movement of the driver's seat can be STOPPED at any time by pressing any button on the seat's control panel.

WARNING! On certain models, the driver's seat is operable with the ignition OFF.
Therefore, children should never be left unattended in the car.

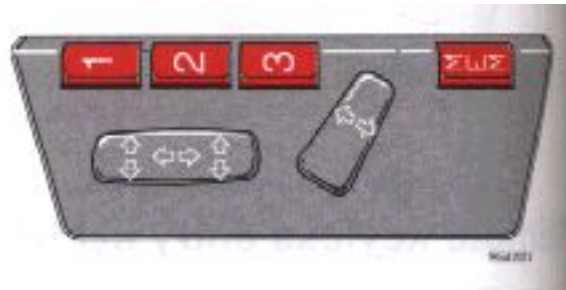

Programming the memory

Three seat positions can be programmed. To program a seat position:

1. Adjust the seat to the desired position.
2. Depress the MEM button.
3. Press button 1 to program the current position of the seat.

Buttons 2 and 3 can be programmed in the same way for two additional seat positions. To move the seat to a programmed position, depress button 1, 2 or 3 until the seat stops. If the button is released before the seat has reached the programmed position, it will stop as a safety precaution.

pg. 2:5 Rear-/side-view mirrors, Vanity mirror

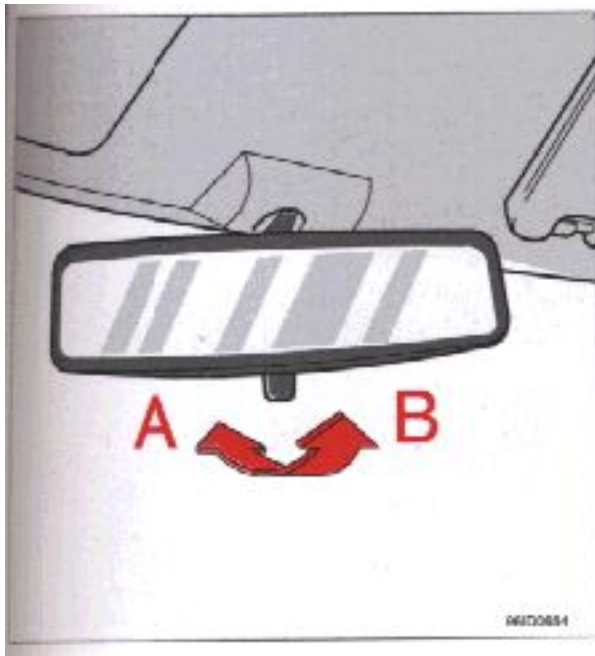

Rear-view mirror

A Normal position

B Night position, reduces glare from following headlights

CAUTION: Never use ice scrapers made of metal as they can easily scratch the mirror surface.

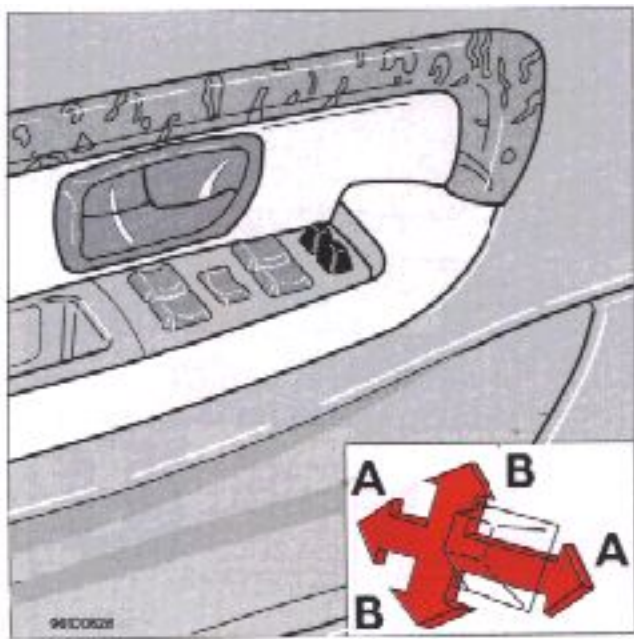

Control switches

Electrically-operated side-view mirrors

The control switches are located in the driver's door armrest.

A Adjustment sideways

B Adjustment up/down

WARNING! Objects seen in the wide-angle right-side mirror are closer than they appear to be.
The mirrors should always be adjusted prior to driving.

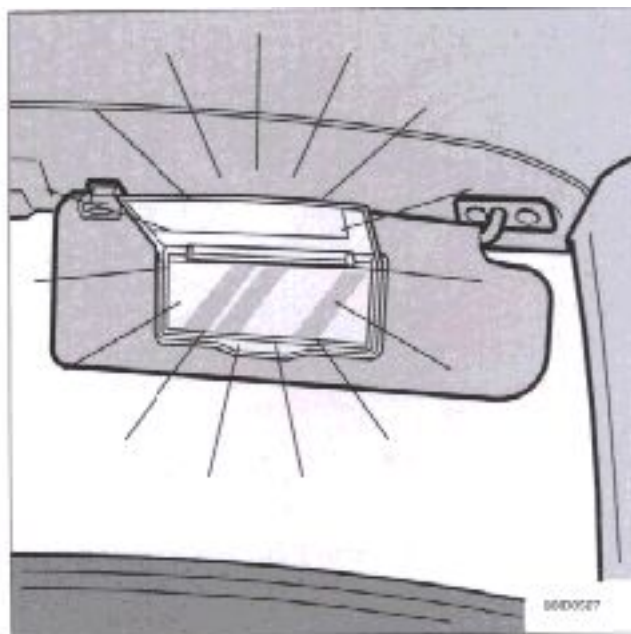

Passenger side mirror shown

Vanity mirrors

The vanity mirrors are located on both front sun visors.

The lamps light up when the covers are opened.



[Contents](#) | [Top of Page](#)

pg. 2:11 Tailgate, Child safety lock (wagon)

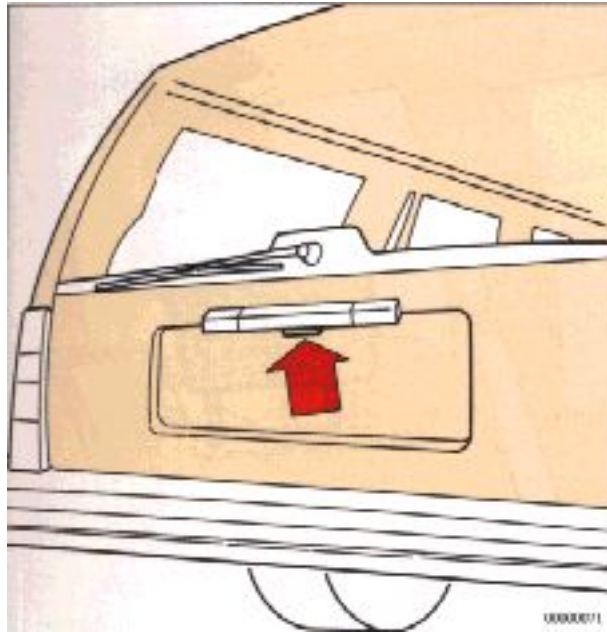

Tailgate

To unlock - turn the key clockwise and allow it to spring back.

To lock - turn the key counter-clockwise and allow it to spring back.

NOTE: The tailgate is also unlocked and locked at the same time as the driver's door.

The tailgate is opened by pressing up the catch on the handle.

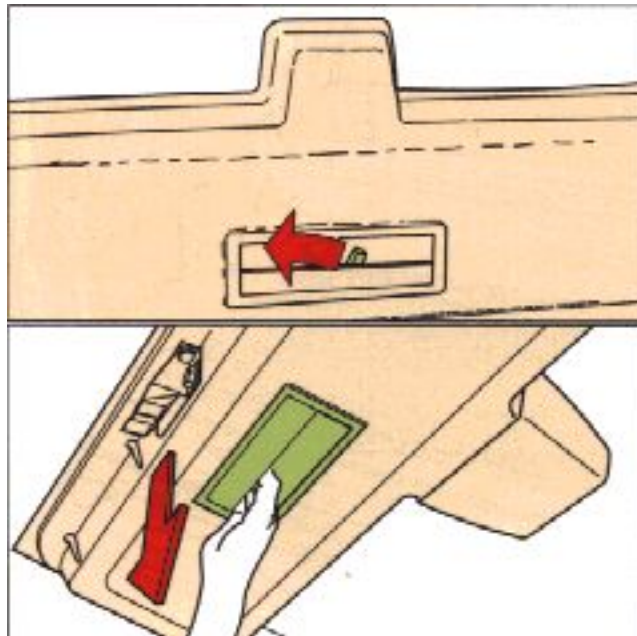

To open the tailgate from the inside of the vehicle move the handle to the left and push outwards. The handle can be used to close the tailgate from the inside (see illustration).

WARNING! Do not drive with tailgate open!
Poisonous exhaust gases may enter via the open tailgate.

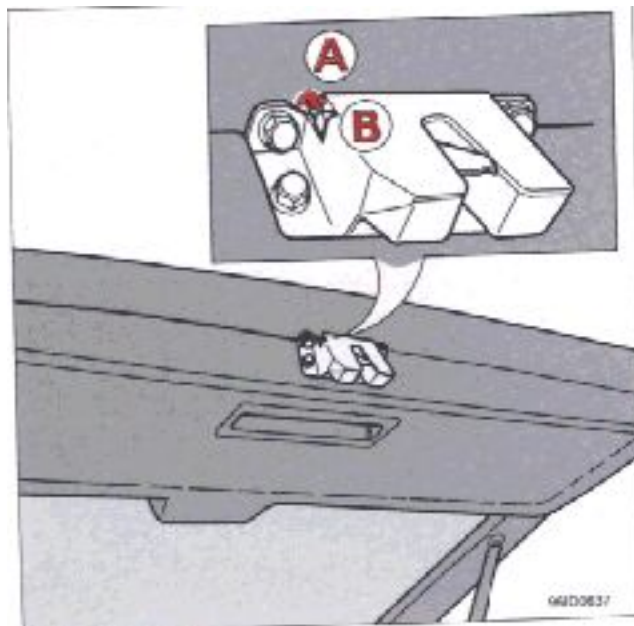

Location and setting of child safety lock

Child Safety lock

The tailgate incorporates a safety catch which is located to the side of the lock.

A the tailgate functions normally

B the tailgate cannot be opened from the inside.

pg. 2:12 Concealed storage bins, Rear seat head restraints (wagon)

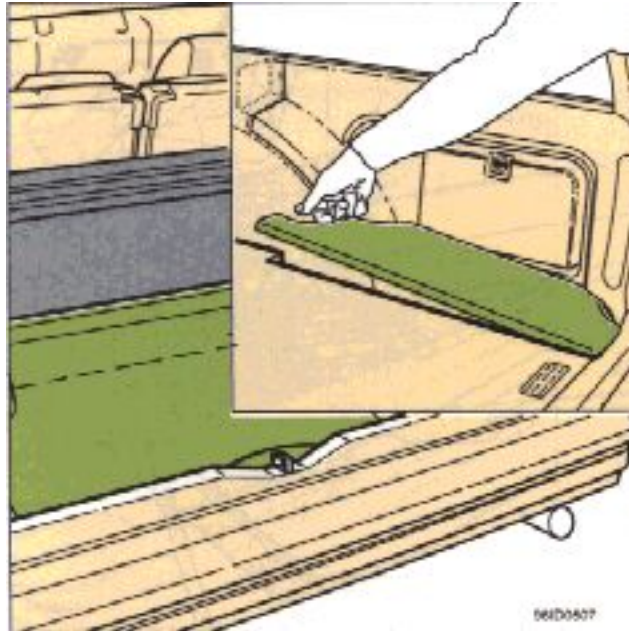

Opening the small storage bin

Concealed storage bins

There are three storage bins under the floor of the cargo space; the largest bin can be locked with a key. The lid of the largest storage bin is hinged in the middle

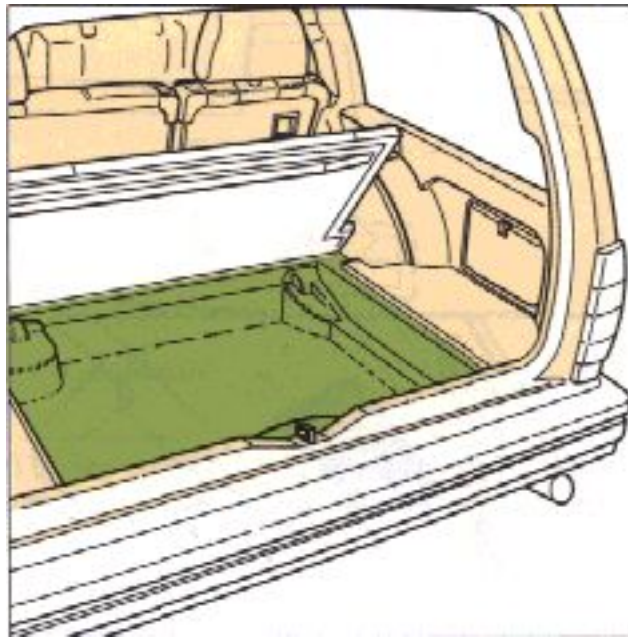

The lid of the largest storage bin is hinged in the middle

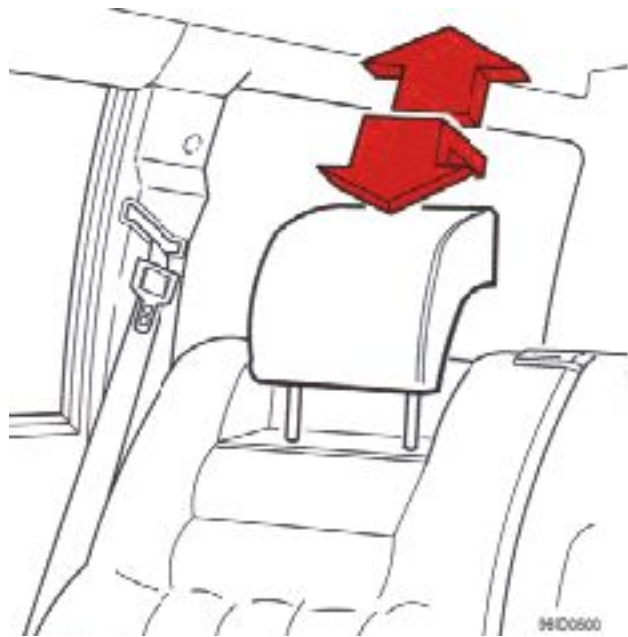

Folding rear seat; increasing the cargo space

The rear head restraints can be raised by pulling straight up or lowered by grasping the restraint, pulling it slightly forward and pushing down.

pg. 2:13 Folding rear seat (wagon)

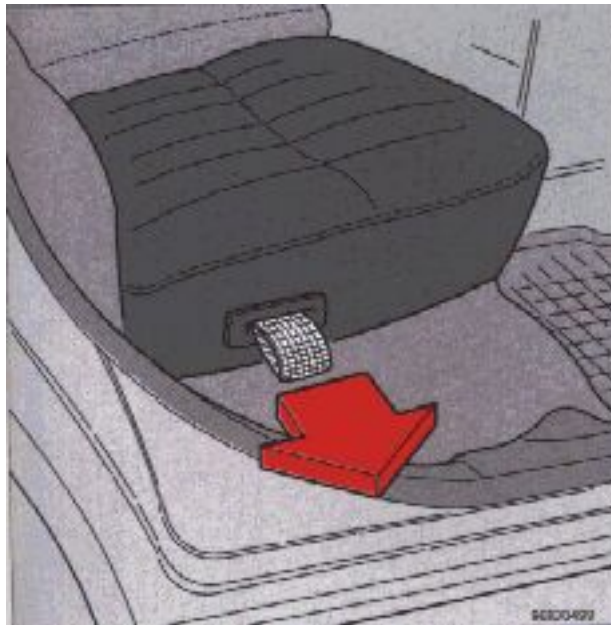

Seat cushion strap

The rear seat is split 60/40 so that each section can be folded independently. Straighten front backrests if they are tilted too far to the rear. Pull the strap to lift the seat cushion and swing the cushion up and toward the back of the front seats. Move the backrest release lever rearward and fold the backrest down. The center head restraint must be lowered manually if it has been raised. The outboard head restraints retract automatically and do not need to be lowered before the backrest is folded down.

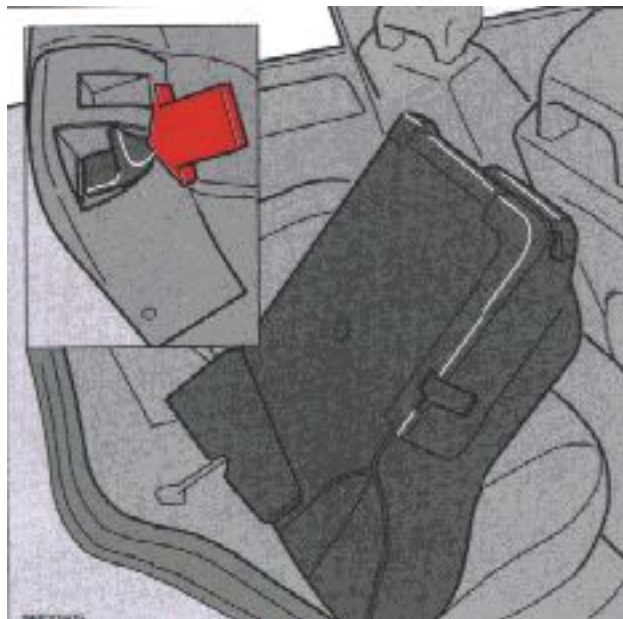

When the backrest is raised, the outboard head restraints return to their normal position and must be raised manually if required. The backrest must lock into place. The red lock indicator will not be visible if the seat has locked into place correctly.

WARNING! When the rear seat is folded down, do not place heavy objects against the backs of the front seats. This places a severe strain on the folded down backrest of the rear seat. Cargo must not be stacked higher than the top of seatbacks. This will reduce the possibility of luggage, etc. becoming projectiles during sudden maneuvers, rapid braking or an accident. The red lock indicator is visible when the backrest is NOT locked in position and not visible when the backrest is correctly locked on place. passengers should never sit in the rear seat when the backrest is not locked in place.



Latches fit into holes

CAUTION: Check that latches under seat cushions engage holes at top edge of backrest.

Seat belts must be correctly positioned as seat is returned to normal position.

pg. 2:14 Removing seat cushions, Tool box, Securing cargo (wagon)

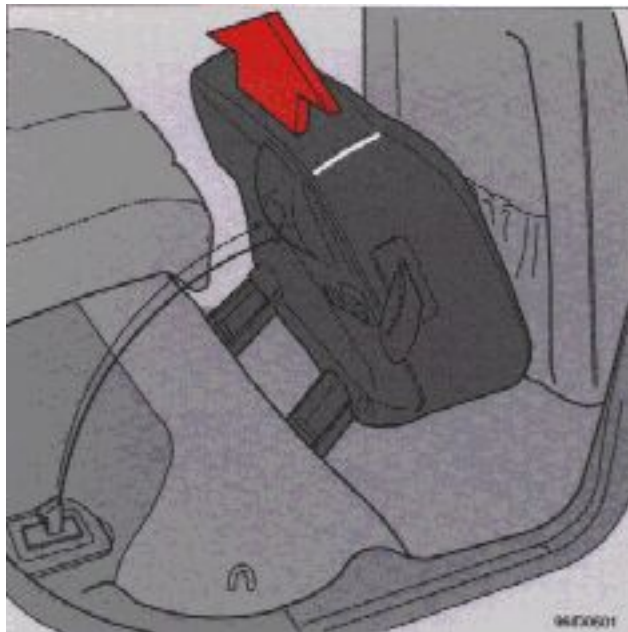

Lift the seat cushion part way and remove the seat.

Removing seat cushions

The seat cushion can be easily removed to provide a slightly larger cargo storage area. To remove, lift the seat cushion out of the hinges.



Tool box

Tool box

The tool box can be released by turning the catch.

WARNING! Do not place extremely heavy articles against the front seats, as the backrest which is

folded down is then placed under severe strain.

Be sure to secure cargo. Hard and sharp articles could otherwise damage the frontseat backrest and/or cause injury to passengers in the event of rapid braking or a collision.

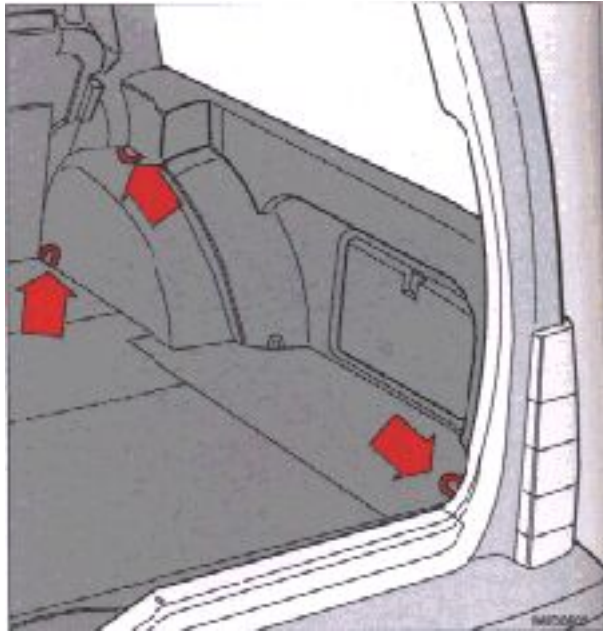

Always secure cargo

Securing cargo

As a safety precaution, the cargo space is equipped with six eyelets to which straps can be attached to secure luggage.

WARNING! The eyelets are not to be used as passenger restraints. See page 3:7. Unless the station wagon is equipped with Volvo's Auxiliary Third Seat (option) passengers should not ride in this section of the car.

pg. 2:15 Cargo space lighting, Spare tire and jack (wagon)

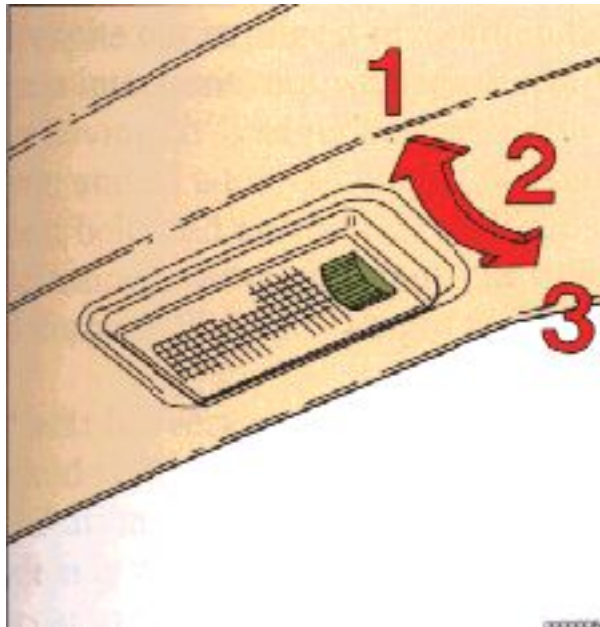

Switch positions

Cargo space lighting

There is an extra courtesy light at the rear of the cargo space.

- 1 Light comes on when the tailgate is opened
- 2 The light is always OFF
- 3 The light is always ON

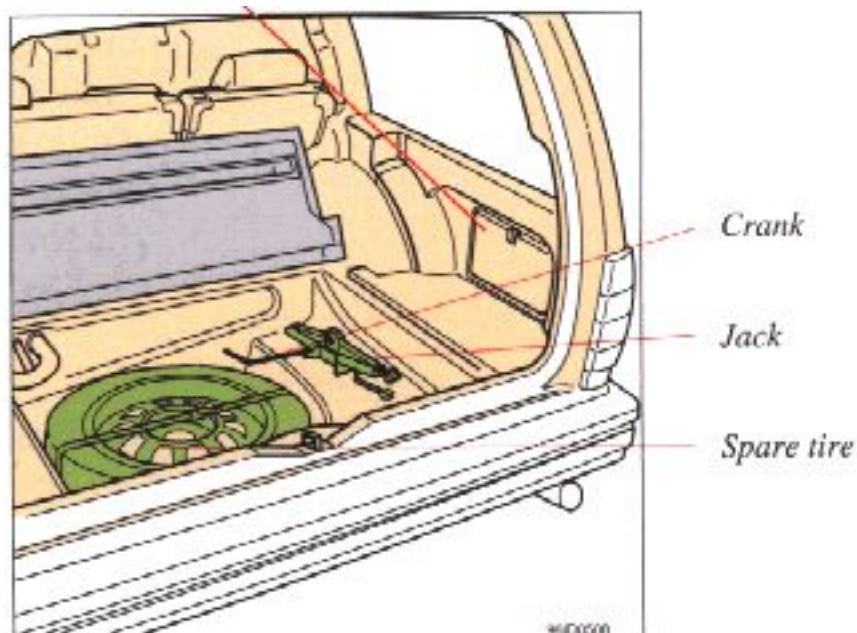

Spare tire and jack

The spare tire and the jack are located beneath the floor mat in the large storage bin. Always secure the

spare tire and the jack to prevent them from rattling.

NOTE: See pages 6:2-6:3 for information on how the jack should be used.



[Contents](#) | [Top of Page](#)

Reading lights for front seats

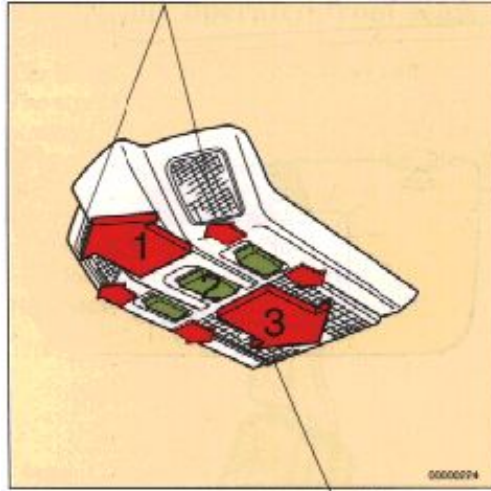

Interior light

Interior light

- 1 Light always on.
- 2 Light always off.
- 3 Light is on when either of the front or the rear doors are opened.

A time-delay device keeps the interior illuminated for approx. 12 seconds after closing the driver's door. This facilitates finding starting (ignition) switch, etc., at night.

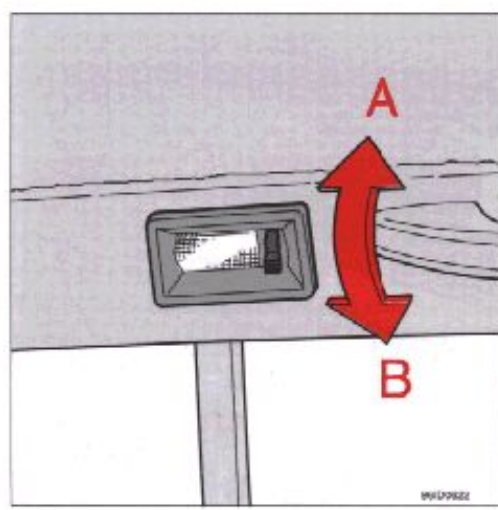

Rear reading lights

Rear seat passengers can turn the rear reading lights on or off by using the adjacent switches.

- A ON
- B OFF

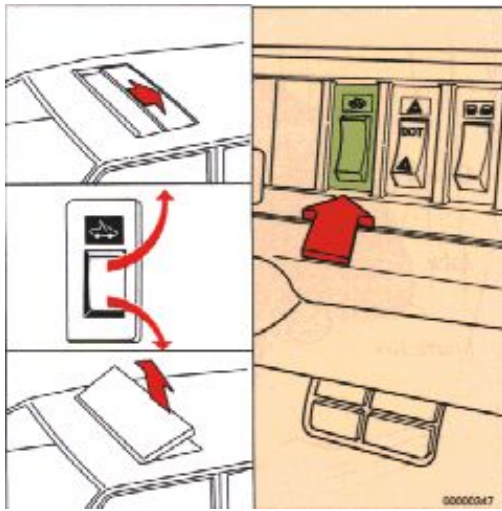

Electrically-operated sun roof

The switch for operating the sun roof is located on the instrument panel. The starting (ignition) key must first be turned to the drive position.

To open the sun roof as a sliding roof, depress the top portion of the switch. To raise the rear edge of the sun roof, depress the bottom portion of the switch. To close the sun roof, depress the side of the rocker switch opposite the side used to open the roof.

NOTE: In case of a sun roof malfunction, see "Emergency sun roof operation", page 6:19.

pg. 2:7 Child safety locks, Trunk lid (sedan)

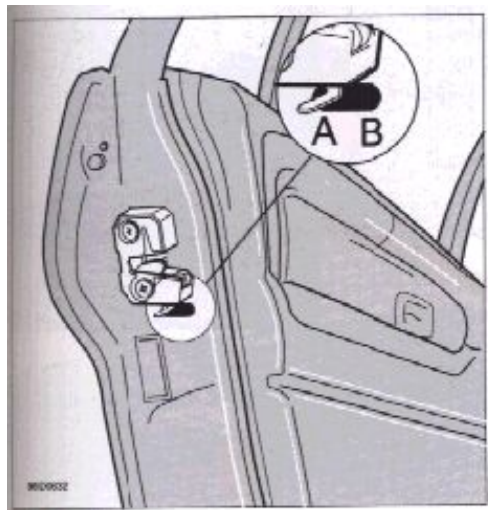

Child safety locks

The buttons are located on the rear door jambs.

A The door lock functions normally.

B The door cannot be opened from the inside. Normal operation from outside.

WARNING!

Remember, in the event of an accident, the rear seat passengers cannot open the doors from the inside with the buttons in position B.



Trunk lid

The trunk lock is incorporated in the central locking system. This means that you can either lock or unlock the trunk by means of the driver's door lock.

You can also operate the trunk lock directly with the master key even if the vehicle is centrally locked.

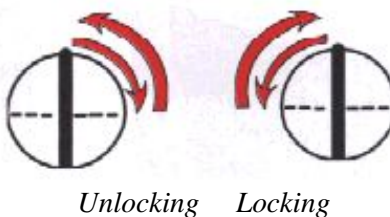

Withdraw key in vertical position.

The trunk lock can also be disconnected from the central locking system by turning the key counterclockwise as shown below:



Withdraw key in horizontal position.

The trunk is now always locked.

This option can be used if for example, you lend your car to somebody. If you give only the service key to the driver it will not be possible to open the trunk.

To reconnect the lock to the central locking system:



Withdraw key in vertical position.

pg. 2:8 Storage spaces



Pocket on rear of front seats

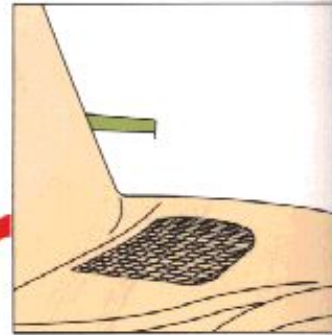

Clip for parking stubs

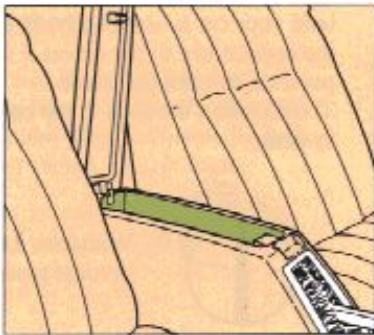
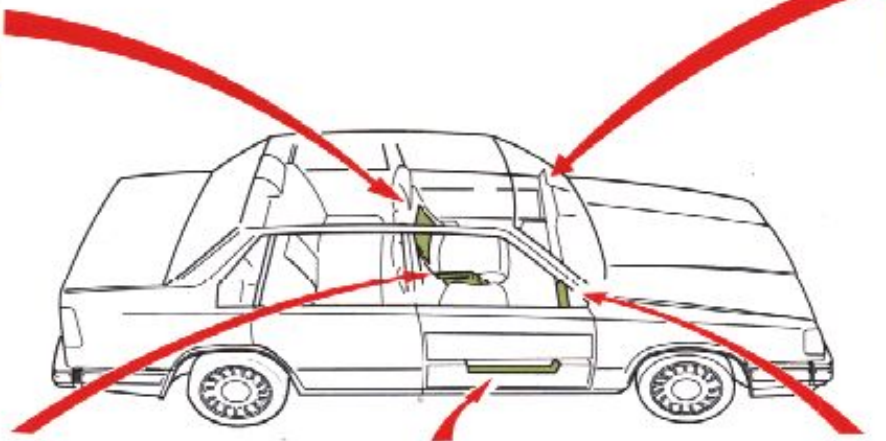

Between front seats



Compartment in front door

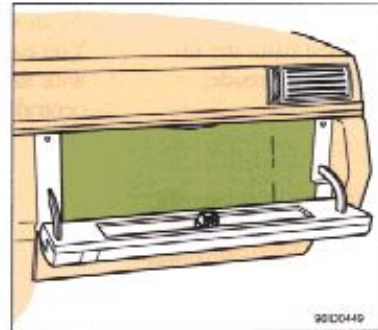

Glove compartment

2:8

WARNING!
Packages on the rear window shelf can obscure vision and may become dangerous projectiles in the event of a sudden stop or accident.

pg. 2:9 Hood

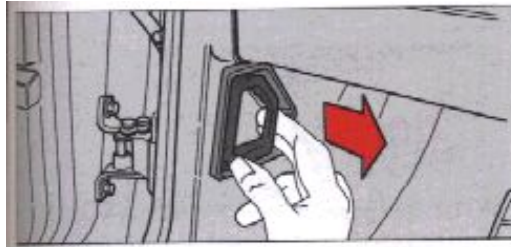

To open the hood

Pull the release handle (located under the left side of the dash).

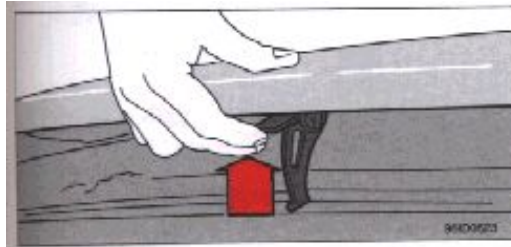

Lift the hood slightly, insert a hand under the center line of the hood and depress the safety-catch handle. Open the hood.

WARNING!
Check that the hood lock properly when closed.

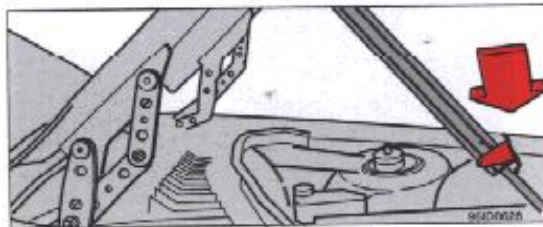
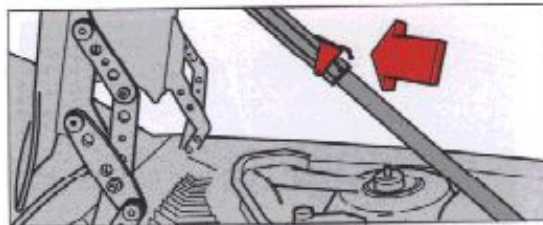

The hood opens normally to an angle of approximately 55°. To open it to a completely vertical position, press both red catches upward as shown in the illustration. Make sure that the catches return to their normal position. When closing the hood, lift it slightly first and then press the catches downward.

Use caution in garages with low roofs.

pg. 2:10 Trunk, Spare tire, Long load storage (sedan)

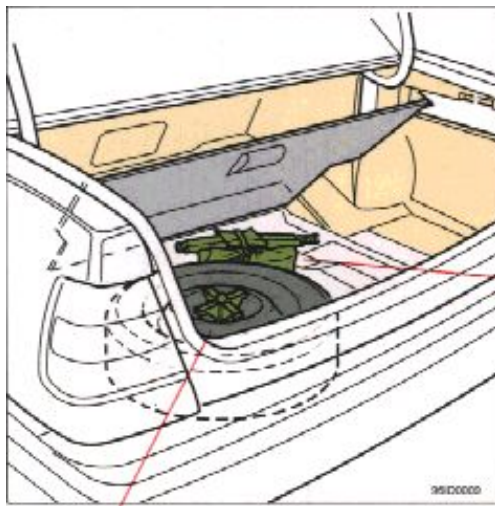

*Tool kit
Jack & Crank handle*

Spare wheel

NOTE: See pages 6:2-6:3 for information on how the jack should be used.



Trunk light

A Light always off.

B Light is on when trunk lid is opened.

Long load storage

In the panel behind the rear seat is a door which makes it possible to carry long loads such as skis, etc.

WARNING!

Cover sharp edges on load to help prevent injury to occupants. Secure load to help prevent shifting during sudden stops.

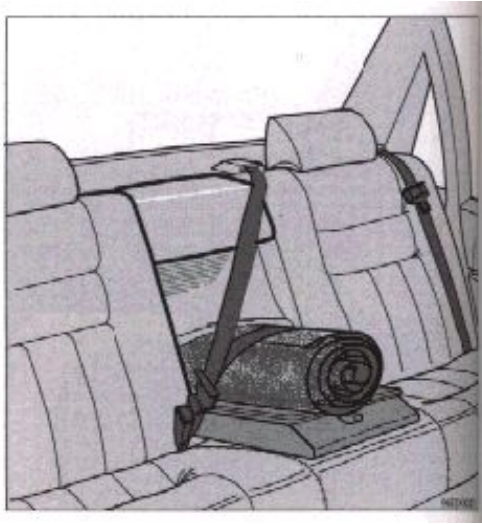

Protective covers (for skis) should also be used to avoid soiling or tearing the upholstery. Please note that the flap in the rear seat is only intended for light loads such as skis, wood etc.

Max. length of load 6 1/2 ft = 2 m.

Max. weight of load 33 lbs = 15 kg.

WARNING!

Always turn engine off and apply parking brake when loading/unloading the vehicle. Place transmission selector in P (PARK) position to help prevent inadvertent movement of selector.



[Contents](#) | [Top of Page](#)

Occupant safety, Reporting Safety Defects

pg. 3:1 Occupant safety

Occupant safety

[3:2](#) Seat belts

[3:4](#) Volvo SRS

[3:7](#) Child safety

[3:10](#) Occupant safety

[3:10](#) Reporting Safety Defects

Despite our strongest recommendations, and your best intentions, not wearing a seatbelt is like believing "it'll never happen to me!". Volvo urges you and all adult occupants of your car to wear seatbelts and ensure that children are properly restrained, using an infant, car or booster seat determined by age, weight and height.

Fact: In every state and province, some type of child-restraint legislation has been passed. Additionally, most states and provinces have already made it mandatory for occupants of a car to use seat belts.

So, urging you to "buckle up" is not just our recommendation - it's becoming the law! The few seconds it takes to buckle up may one day allow you to say, "It's a good thing I was wearing my seatbelt".



pg. 3:2 Seat belts



Seat belts

Always fasten the seat belts before you drive or ride.

Two lights will be illuminated for 4-8 seconds after the starting (ignition) key is turned to the driving position. One light is located in the instrument panel and one in the console between the front seats. A chime will sound at the same time if the driver has not fastened his seat belt. The rear seats are provided with self-retracting inertia reel belts. The front seats are provided with single roller belts with

tensioners.

To buckle:

Pull the belt out far enough to insert the latch plate into the receptacle (buckle for rear seats), until a distinct snapping sound is heard. The seat belt retractor is normally "unlocked" and you can move freely, provided that the shoulder belt is not pulled out too far. The retractor will lock up as follows:

- if belt is pulled out rapidly
- during braking and acceleration
- if the vehicle is leaning excessively
- when driving in turns.

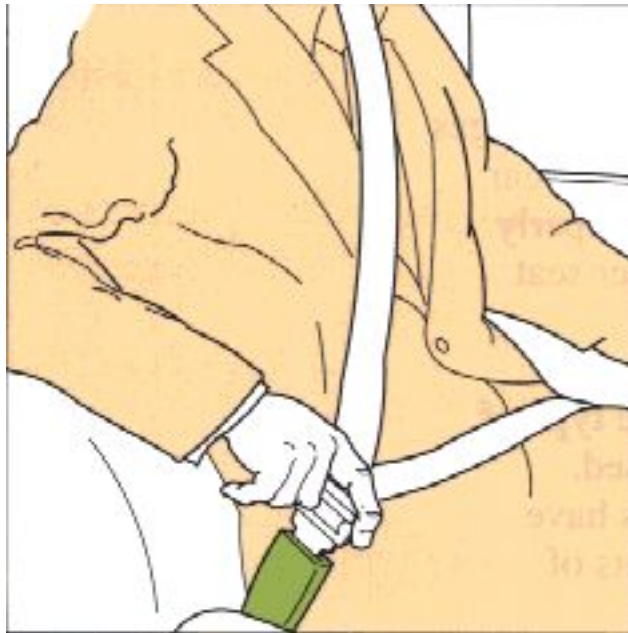

In order for the seat belt to provide maximum protection in the event of an accident, it must be worn correctly. When wearing remember:

- the belt should not be twisted or turned
- the lap belt must be positioned low on the hips (not pressing against the abdomen). Make sure that the shoulder belt is rolled up into its retractor and that the shoulder and lap belts are taut.

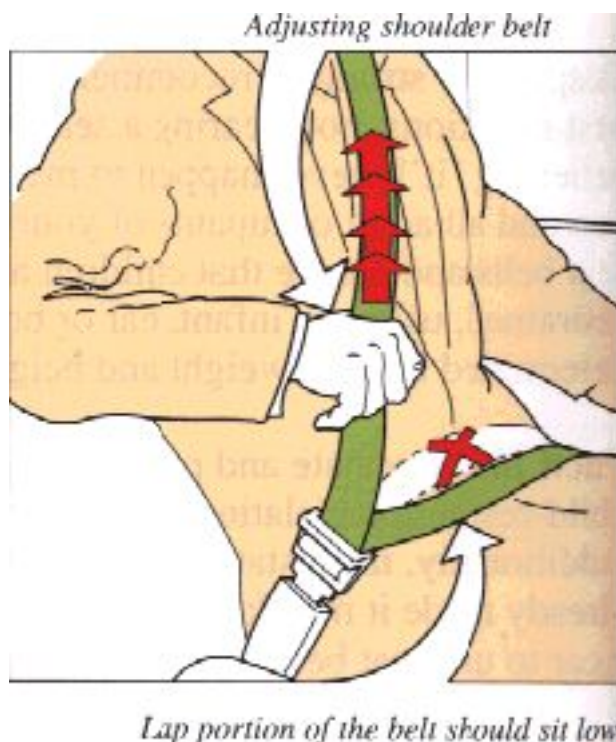

Before exiting the car, check that the seat belt retracts fully after being unbuckled. If necessary, guide the belt back into the retractor slot.

WARNING! Any device used to induce slack into the shoulder belt portion of the three-point system will have a detrimental effect on the amount of protection available to you in the event of a collision. The seat back should not be tilted too far back. The shoulder belt must be taut in order to function properly.



Center head restraint

The center head restraint can be adjusted according to the passenger's height. The restraint should be carefully adjusted to support the occupant's head.



During pregnancy

Pregnant women should always wear seat belts.

Remember that the belt should always be positioned in such a way as to avoid any possible pressure on the abdomen. The lap portion of the belt should be located low, as shown in the above illustration.

WARNING! Never use a seat belt for more than one occupant. Never wear the shoulder portion of the belt under the arm or otherwise out of position. Such use could cause injury in event of accident. As the seat belts lose much of their strength when exposed to violent stretching, they should be replaced after any collision, even though they may appear to be undamaged. Never repair the belt on your own; have this done by an authorized Volvo dealer only.

NOTE:

Legislation in your state or province may mandate seat belt usage.

pg. 3:4 Volvo SRS

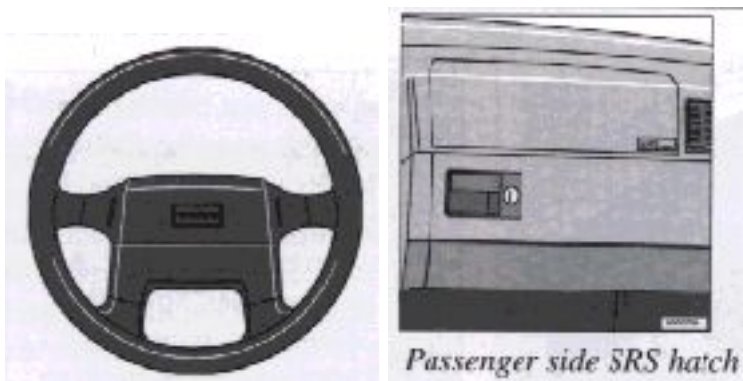

As an enhancement to the three-point seat belt system, your Volvo is equipped with a Supplemental Restraint System (SRS). The Volvo SRS consists of an airbag (2) and knee bolster (5) on both the driver's and passenger's sides and seat belt tensioners in both front door pillars (4). The system is designed to supplement the protection provided by the three-point seat belt system.

The interior of an SRS-equipped Volvo looks very much the same as any other. The only indications of the system's presence are the "SRS" embossed on the steering wheel pad and above the glove compartment, the knee bolsters beneath the steering column and the glove compartment and a decal on the far right side of the dash.

The airbags are folded and located in the center of the steering wheel and above the glove compartment. They are released only during certain frontal or front-angular collisions, depending on the crash severity, angle, speed and object impacted. Both air bags and seat belt tensioners will deploy, even if the passenger seat is not occupied.

WARNING!

As its name implies, SRS is designed to be a SUPPLEMENT to - not a replacement for - the three-point belt system. The airbag is designed not to be released in the event of a side or rear-end collision, or during a rollover situation. For maximum protection, wear seat belts at all times. Be aware that no system can prevent all possible injuries that may occur in an accidents.



The airbag system includes gas generators (1) surrounded by the airbags (2) and front seat belt tensioners for both of the front seats (4). To deploy the system, the sensor (3) activates the gas generators causing the airbags to be inflated with nitrogen gas. As the movement of the seats' occupants compresses the airbags, some of the gas is expelled at a controlled rate to provide better cushioning. Both seat belt tensioners also deploy, minimizing any seat belt slack.

The entire process, including inflation and deflation of the airbags, takes approximately two-tenths of a second.

WARNING!

When installing any optional equipment make sure that the SRS system is not damaged. Do not attempt to service any component of the SRS yourself. Attempting to do so may result in serious personal injury. If a problem arises, take your car to the nearest authorized Volvo Dealer for inspection as soon as possible.



A self-diagnostic system incorporated in the sensor monitors the SRS. If a fault is detected, the "SRS" warning light will illuminate. The light is included in the warning/indicator light cluster in the instrument panel. Normally, the SRS warning lamp should light up when the ignition is switched on and should go out after 10 seconds or when the engine is started. Check that this light is functioning properly every time the car is started.

The following items are monitored by the self-diagnostic system:

- Sensor unit
- Cable harness
- Gas generator ignitors

WARNING! Never drive and SRS equipped car with your thumbs on the steering wheel pad / airbag housing.

WARNING! If the SRS warning light stays on after the engine has started or if it comes on while you are driving, drive the car to the nearest authorized Volvo Dealer for inspection as soon as possible.



The above is a sample of the label found on all seat belts equipped with tensioners, located on the front seat belts near the lower anchorage point.

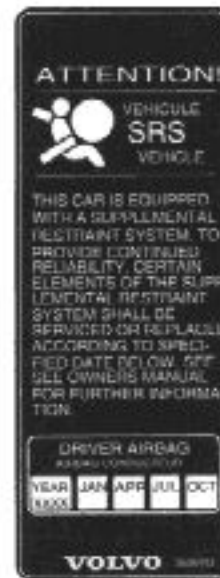

The above is a sample of the decals which can be found on both front door pillars.

There is no maintenance to perform on the SRS yourself. The only periodic maintenance recommended on the SRS is that the air bag modules and front seat belts (including tensioners) should be replaced approximately every ten years and that the other components in the system (wiring, connectors, etc.) should also be inspected at this time. The SRS decal on your car shows the month and year servicing is due. This service must be performed by an authorized Volvo dealer.

Should you have any questions about the SRS system, please contact your authorized Volvo Dealer or the Consumer Affairs Department.

pg. 3:6 Volvo SRS (cont.)

WARNING

This car is equipped with a full frontal Supplemental Restraint System (SRS) with AIRBAG in front of the driver and front passenger.

***ALL OCCUPANTS MUST BE PROPERLY RESTRAINED, ADULTS USING SEAT-BELTS AND CHILDREN USING CHILD RESTRAINT SYSTEMS.**



***DO NOT INSTALL AND USE ANY CHILD RESTRAINTS IN THE FRONT SEAT.**

We also recommend that children who have outgrown child restraint systems in the rear seat with the seat-belt properly fastened. The safest place in the car for children is in the rear seat.

FAILURE TO FOLLOW THESE INSTRUCTIONS CAN RESULT IN INJURY TO THE VEHICLE OCCUPANTS IN AN ACCIDENT.

For further information, see owner's manual.

VOLVO

SRS text at far right of instrument panel and on inside of driver side sun visor

WARNING! Do not use child safety seats or child booster cushion/backrests in the front passenger's seat. We also recommend that children who have outgrown these devices sit in the rear seat with the seat belt properly fastened.

In order for the SRS system to provide the protection intended, seat belts must be worn at all times.

General SRS information

In a collision where deployment occurs, both air bags and seat belt tensioners activate. Some noise occurs and a small amount of powder is released. This powder is not harmful and does not indicate fire.



Passenger side air bag

NOTE. Deployment of SRS components occurs only one time during an accident.

If you are involved in an accident which has resulted in air bag deployment, we recommend the following:

- Have the car towed to an authorized Volvo dealer or collision repair shop. Even if the car is driveable after an accident, we do NOT recommend driving the car with deployed air bags.
- Have the SRS replacement performed by an authorized Volvo dealer OR ask the body shop performing the collision repairs to have the SRS replacement done at a Volvo dealer.
- Have all deployed/damaged SRS components (air bags and front seat belt assemblies) replaced with new, genuine Volvo-brand components.

WARNING! (Passenger side air bag)

- Occupants in the front passenger's seat must never sit on the edge of the seat, sit leaning toward the instrument panel or otherwise sit out of position. The occupant's back must be as upright as comfort allows and be against the seat back with the seat properly fastened.
- Feet must be on the floor, e.g. not on the dash, seat or out of the window.
- Children must never be allowed to stand in front of the passenger seat.
- No objects or accessory equipment, e.g. dash covers, may be placed on, attached to or installed near the SRS hatch (the area above the glove compartment) or the area affected by air bag deployment (see illustration).
- There should be no loose articles, e.g. coffee cups, on the floor, seat or dash area.
- Never try to open the SRS cover on the steering wheel or the passenger side SRS hatch. This should only be done by an authorized Volvo service technician.



[Contents](#) | [Top of Page](#)

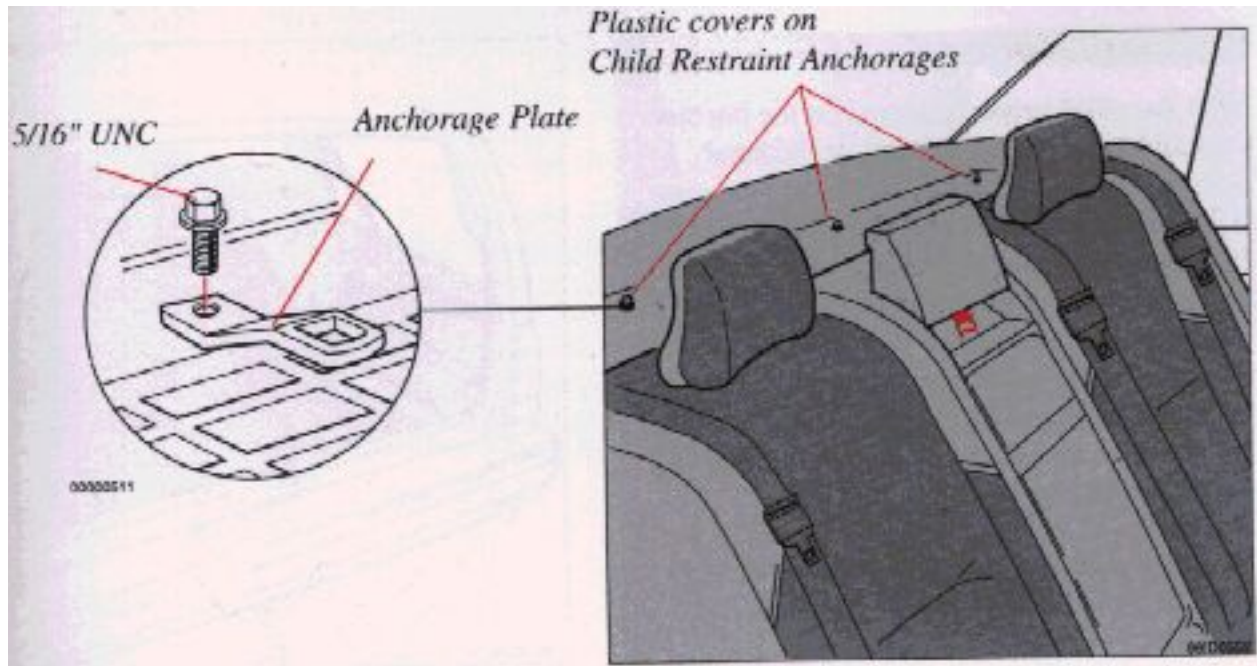

Child Restraint Anchorages

Volvo cars are fitted with Child Restraint Top Tether Anchorages in the rear seat. There are three anchorages under the rear section of the car's rear window shelf on sedans and on the back rest on wagons. The backrest on wagons must be folded down slightly to reach the anchorages. When the car is delivered, the holes for these anchorages are covered by plastic covers. In cars designated for Canada, one top tether anchorage set will be in the glove box.

The top tether anchorage set includes the top tether anchorage plate, an 5/16" UNC bolt and a plastic trim cover.

If another set is needed, consult your Volvo dealer.

Installing the top tether

Remove the plastic cover on the anchorage point you want to use. This can be done with a suitable coin. The cover is removed counter-clockwise. Refer to the child seat manufacturer's instructions for securing the seat.

An additional bolt may be required for sedans. This may be obtained from your authorized Volvo dealer.



*Plastic covers on Child Restraint Anchorages
(located behind the hinged flap)*

WARNING!

Child Restraint Anchorages are designed to withstand only those loads imposed by correctly fitted Child Restraints. Under no circumstances are they to be used for adult seat belts or harnesses.

The anchorages are not able to withstand excessive forces on them in the event of collision if full harness seat belts or adult seat belts are installed to them. An adult who uses a belt anchored in a Child Restraint Anchorage runs a great risk of suffering severe injuries should a collision occur.

pg. 3:8 Child safety (cont.)



Integrated booster cushion

Integrated booster cushion

Volvo's own integrated booster cushion has been specially designed to help safeguard a child seated in the center position of the rear seat. In combination with the standard three-point seat belt, it is approved for children weighing between 50 and 80 lbs (23 and 36 kg) and between 46 and 54 inches (108 and 135 cm) in height. Press button A to fold up the booster cushion when it is not in use.

Sedan

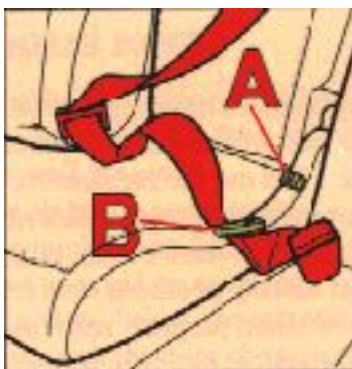

With the child seated on the cushion, the hip section of the three-point belt must pass through seat belt guide B.

Wagon

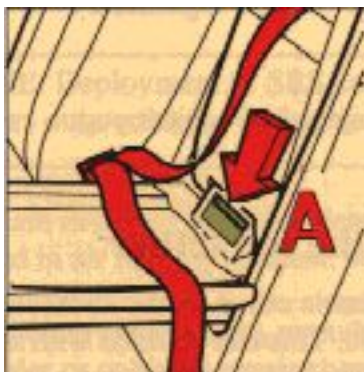

The hip section of the three-point seat belt must fit snugly across the child's hips, not across the stomach.

WARNING!

In the event of a collision while the integrated booster cushion was occupied, the entire booster cushion and center seat belt must be replaced. The booster cushion should also be replaced if it is badly worn or damaged in any way. This work should be performed by an authorized Volvo dealer only. The booster cushion should be cleaned while in place in the vehicle if possible. If not, please consult your Volvo dealer.

Child safety

Volvo recommends the proper use of restraint systems for all occupants including children. Remember that, regardless of age and size, a child should always be properly restrained in a car.

Restraint systems for children are designed to be secured in the vehicle by lap belts or the lap portion of a lap-shoulder belt. Such child restraint systems can help protect children in cars in the event of an accident only if they are used properly. However, children could be endangered in a crash if the child restraints are not properly secured in the vehicle. Failure to follow the installation instructions for your child restraint can result in your child striking the vehicle's interior in a sudden stop.

Holding a child in your arms is NOT a suitable substitute for a child restraint system. In an accident, a child held in a person's arms can be crushed between the vehicle's interior and an unrestrained person. The child could also be injured by striking the interior, or by being ejected from the vehicle during a sudden maneuver or impact. The same can also happen if the infant or child rides unrestrained on the seat. Other occupants should also be properly restrained to help reduce the chance of injuring or increasing the injury of a child. All states and provinces have legislation governing how and where children should be carried in a car. Find out the regulations existing in your state or province. Recent accident statistics have shown that children are safer in rear seating positions than front seating positions when properly restrained. A child restraint system can help protect a child in a vehicle. Here's what to look for when selecting a child restraint system:

- It should have a label certifying that it meets applicable Federal Motor Vehicle Safety Standards (FMVSS 213-80) - or in Canada, CMVSS 213.
- Make sure the child restraint system is approved for the child's height, weight and development - the label required by the standard or regulation, or instructions for infant restraints, typically provide this information.
- In using any child restraint system, we urge you to look carefully over the instructions that are provided with the restraint. Be sure you understand them and can use the device properly and safely in this vehicle. A misused child restraint system can result in increased injuries for both the infant or child and other occupants in the vehicle.
- If your child restraint requires a top tether strap, consult your authorized Volvo dealer for top tether anchorage and installation information.

When a child has outgrown the child safety seat, you should use the rear seat with the standard seat belt fastened. The best way to help protect the child here is to place the child on a cushion so that the seat belt is properly located on the hips.

A specially designed and tested safety cushion for this purpose can be obtained from your Volvo dealer. If necessary, an auxiliary seat is available for use in the luggage compartment of station wagon models. This seat is designed for two children, each up to 88 lbs. in weight and up to 59 inches in height.

Seat belt maintenance

Check periodically that the anchor bolts are secure and that the belts are in good condition. Use water and a mild detergent for cleaning. Check seat belt mechanism function as follows:

Attach the seat belt and pull rapidly on the strap.

WARNING! Check other traffic before performing the following check.

Brake firmly from approximately 30 mph (50 km/h) or turn in a tight circle while pulling on the belt. In the above checks you should not be able to pull the belt out.

Volvo Concern for Safety

Safety is the cornerstone for Volvo. Our concern dates back to 1927 when the first Volvo rolled off the production line. Three-point seat belts, safety cages, and energy-absorbing impact zones were designed into Volvo cars long before it was fashionable or required by government regulation. We will not compromise our commitment to safety. We continue to seek out new safety features and to refine those already in our cars. You can help. We would appreciate hearing your suggestions about improving automobile safety. We also want to know if you ever have a safety concern with your car.

Occupant safety

How safely you drive doesn't depend on how old you are but rather on:

- how well you see
- your ability to concentrate
- how quickly you make decisions under stress to avoid an accident.

The tips listed below are suggestions to help you cope with the ever changing traffic environment.

- Never drink and drive.
- If you are taking any medication, consult your physician about its potential effects on your driving abilities.
- Take a driver-retraining course
- Have your eyes checked regularly
- Keep your windshield and headlamps clean.
- Replace wiper blades when they start to leave streaks.
- Take into account the traffic, road, and water conditions, particularly with regard to stopping distance.

Reporting Safety Defects in the U.S.

If you believe that your vehicle has a defect which could cause a crash or could cause injury or death, you should immediately inform the National Highway Traffic Safety Administration (NHTSA) in addition to notifying Volvo Cars of North America. If NHTSA receives similar complaints, it may open an investigation, and if it finds that a safety defect exists in a group of vehicles, it may order a recall and remedy campaign. However, NHTSA cannot become involved in individual problems between you, your retailer, or Volvo Cars of North America. To contact NHTSA, you may either call the Auto Safety Hotline toll-free at 1-800-424-9393 (or 366-0123 in Washington, D.C. area) or write to: NHTSA, U.S. Department of Transportation, Washington D.C. 20590. You can also obtain other information about motor vehicle safety from the Hotline.



[Contents](#) | [Top of Page](#)

Starting and driving

pg. 4:1 Starting and driving

Starting and driving

This section on starting and driving contains items such as starting the engine, operating gear selector, towing, trailers.

- [4:2](#) Break-in period
- [4:3](#) Fuel requirements, Refueling
- [4:4](#) Economical driving
- [4:5](#) Starting the engine
- [4:6](#) Automatic Transmission
- [4:8](#) Points to remember
- [4:11](#) Emergency towing
- [4:12](#) Vehicle Towing Information
- [4:13](#) Starting with an auxiliary battery
- [4:14](#) Three-way catalytic converter
- [4:15](#) Brake system
- [4:16](#) Towing a trailer
- [4:17](#) Winter driving
- [4:18](#) Before a long distance trip
- [4:19](#) Vehicle storage

pg. 4:2 Break-in period, Fuel requirements

A new car should be broken-in!

Refrain from utilizing your car's full driving potential during the first 1,200 miles (2,000 km).

Automatic transmission

Do not use "kick-down" during the first 1,200 miles (2,000 km).

NOTE - ENGINE OIL:

Although some oil consumption during normal engine operation, more oil is consumed when the engine is new as the internal parts generate higher friction while wearing-in to each other. From the time the engine is new until the first service is performed, the oil consumption could be higher than normal. For this reason, it is especially important to check the oil every time you refuel your car during this period. See page 8:6.

In general, the rate of oil consumption depends on such factors as: engine temperature, length of trip, driving conditions, oil viscosity and quality, engine speed and acceleration/deceleration. Checking your engine oil level each time the car is refuelled is one of the most important items you can perform to help keep your car in good running order.

Breaking-in parking brake (hand brake)

To obtain best parking brake performance, the brake linings should be broken-in. Stop 5-7 times from 30 mph (50 km/h), transmission in neutral, applying the parking brake with the release button pressed in during the stop.

The force must not lock the rear wheels. If this happens, release the brake enough to let the wheels rotate. Drive a mile between each stop to cool the brakes. Check for proper parking brake operation.

WARNING!

The brake lights are not illuminated when applying the parking brake. To warn traffic from behind it is therefore advisable to depress the brake pedal slightly to illuminate the brake lights.

Deposit control gasoline

Volvo recommends the use of gasoline containing deposit control additives. These additives have shown to be efficient in keeping injectors and intake valves clean. Consistent use of deposit control gasolines will help ensure good driveability and fuel economy. If you are not sure whether the gasoline contains deposit control additives, check with the service station operator.

NOTE:

Do not add additives yourself to the gasoline, unless you are recommended to do so by an authorized Volvo dealer.

pg. 4:3 Fuel requirements, Refueling

Unleaded Fuel

Each Volvo has a three-way catalytic converter and must use only unleaded gasoline (as specified on the instrument panel and by a label near the filler inlet.). U.S. and Canadian regulations require that pumps delivering unleaded gasoline be labeled "UNLEADED". Only these pumps have nozzles which fit your car's filler inlet. It is unlawful to dispense leaded fuel into a vehicle labeled "unleaded gasoline only". Leaded gasoline damages the three-way catalytic converter and the heated oxygen sensor system. Repeated use of leaded gasoline will lessen the effectiveness of the emission control system and could result in loss of emission warranty coverage. State and local vehicle inspection programs will make detection of misfueling easier, possibly resulting in emission test failure for misfueled vehicles.

Octane Rating

Volvo engines are designed for optimum performance on unleaded premium gasoline with an octane rating, AKI of 91, or above. AKI (ANTI KNOCK INDEX) is an average of the Research Octane Number, RON, and the Motor Octane Number, MON, $(RON + MON / 2)$. The minimum octane requirement is AKI 87 (RON 91).

Gasoline Containing Alcohol and Ethers

"Oxygenated fuels"

Some fuel suppliers sell gasoline containing "oxygenates" which are usually alcohols or ethers. In some areas, state or local laws require that the service pump be marked indicating use of alcohol or ethers. However, there are areas in which the pumps are unmarked. If you are not sure whether there is alcohol or ethers in the gasoline you buy, check with the service station operator. To meet seasonal air quality restrictions, some states require the use of "oxygenated" fuel in certain areas.

Volvo allows the use of the following "oxygenated fuels"; however, the octane ratings listed on this page must still be met.

Alcohol -- Ethanol

Fuels containing up to 10% ethanol by volume may be used.

Ethanol may also be referred to as Ethyl alcohol, or "Gasohol".

Ethers -- MTBE

Fuels containing up to 15% MTBE may be used.

Refueling

The fuel tank filler cap is located behind the door on the left rear fender. Open cap slowly during hot weather conditions.

When filling, position the cap in the special bracket on the door.

After filling the tank, install the cap and turn until a "click" is heard.

The fuel tank is designed to hold approximately 21.1 US gals (80 liters) sedan, 19.8 US gal. (75 liters)

wagon, with sufficient volume left over to accommodate possible expansion of the fuel in hot weather. Be aware that the "usable" tank capacity will be somewhat less than the specified maximum. When the fuel level is low, such factors as ambient temperature, the fuel's "vapor pressure" characteristics, and terrain can affect the fuel pumps' ability to supply the engine with an adequate supply of fuel. Therefore, it is advisable to refuel as soon as possible when the needle nears the red zone, or when the fuel warning light comes on.

CAUTION: Take care not to spill gasoline during refueling. Gasolines containing alcohol can cause damage to painted surfaces, which may not be covered under the New Vehicle Limited Warranty. Do not use gasoline containing methanol (methyl alcohol, wood alcohol). This practice can result in vehicle performance deterioration and can damage critical parts in the fuel system. Such damage may not be covered under the New Vehicle Limited Warranty.

pg. 4:4 Driving economy

Economical driving does not necessarily mean driving slowly

Better driving economy may be obtained by thinking ahead, avoiding rapid starts and stops and adjusting the speed of your vehicle to immediate traffic conditions. Observe the following rules:

- Bring the engine to normal operating temperature as soon as possible by driving with a light foot on the accelerator pedal for the first minutes of operation. A cold engine uses more fuel and is subject to increased wear.
- Whenever possible, avoid using the car for driving short distances. This does not allow the engine to reach normal operating temperature.
- Drive carefully and avoid rapid acceleration and hard braking.
- Do not exceed speed limit.
- Avoid carrying unnecessary items (extra load) in the car.
- Check tire pressure regularly (check when tires are cold).
- Remove snow tires when threat of snow or ice has ended.
- Note that roof racks, ski racks, etc., increase air resistance and thereby fuel consumption.
- Avoid using automatic transmission kick-down feature unless necessary.
- Avoid using the air conditioning when it is not required. When engaged, the air conditioner's compressor places an additional load on the engine.

Other factors which decrease gas mileage are:

- Low tire pressure
- Worn or dirty spark plugs
- Incorrect spark plug gap
- Dirty air cleaner

- Dirty engine oil and clogged oil filter
- Dragging brakes
- Incorrect front end alignment

Some of the above mentioned items and others are checked at the standard Maintenance Service intervals.

NOTE: Since using (D)rive improves fuel economy, it should be used as often as possible.

pg. 4:5 Starting the engine

Starting and stopping a car equipped with automatic transmission

1 Fasten the seat belt.

WARNING! Before starting, check that the seat is adjusted properly. Make sure the brake pedal can be depressed completely. Move the seat closer if necessary. Refer to section "Front seats".

2 Apply the parking brake, if not already set. The gear selector is locked in the (P)ark position (SHIFTLOCK).

3 Without touching the accelerator pedal , turn the ignition key to the starting position. Allow the starter to operate for 5-10 seconds. Release the key as soon as the engine starts. If the engine fails to start, repeat step 3.

For cold starts at altitudes above 6000 ft (1800 m), depress the accelerator pedal halfway and turn the key to the starting position. Release the accelerator pedal slowly when the engine starts.

4 To release the gear selector, depress the brake pedal . See page 6:19 for instructions on manually overriding the SHIFTLOCK system if the lever cannot be moved. Do not race a cold engine immediately after starting. Oil flow may not reach some lubricating points fast enough to prevent engine damage.

5 Select desired gear. The gear engages after a slight delay, especially noticeable when selecting R.

CAUTION: Engine should be idling; never accelerate until after you feel the gear engage! Too rapid acceleration immediately after selecting a gear will cause harsh engagement and premature transmission wear.

6 Release the brakes and accelerate.

To stop the car, release the accelerator pedal and apply the brakes.

NOTE: Your car is equipped with a KEYLOCK switch system. When the engine is switched off, the gear selector must be in the (P)ark position before the key can be removed from the ignition switch.

WARNING!

Never leave car unattended with engine running.

Always open the garage doors fully before starting the engine inside a garage to ensure adequate ventilation. The exhaust gases contain carbon monoxide, which is invisible and odorless but very poisonous.

Engine warm-up initial driving procedure

Engines in vehicles driven short distances are subject to abnormally rapid wear because the engine never reaches normal operating temperature. It is therefore beneficial to reach normal operating temperature as soon as possible. This is best achieved by driving with a light foot on the accelerator pedal for a few minutes after starting, rather than prolonged idling.

B 6304 S (6-cylinder engine)

This engine features hydraulic valve lifters which means that valve clearance is adjusted automatically. It is possible that the valve lifters will produce a ticking sound for the first few seconds after the engine is started, while the oil pressure is increasing.

If the car has not been used for a long period of time, this ticking sound may last for up to 15 minutes. This is entirely normal.

NOTE: Do not exceed 3000rpm until the ticking sound disappears.

NOTE:
 Selecting position P or N when idling at a standstill for prolonged periods of time will help prevent overheating of the transmission oil.

pg. 4:6 Automatic transmission AW 30/4

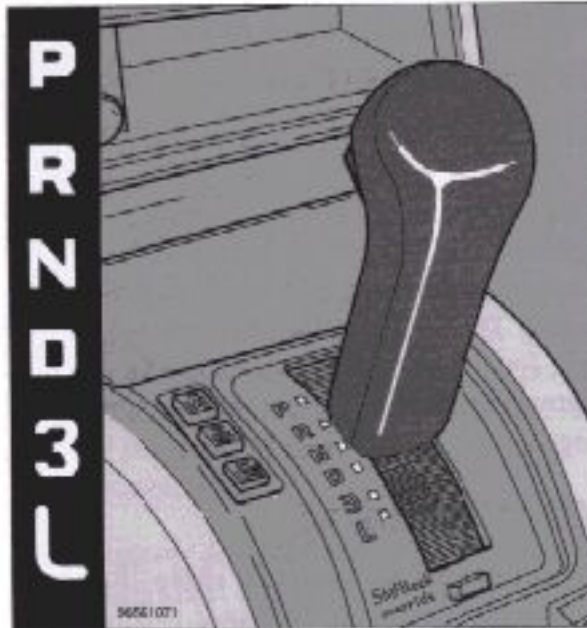

P (Park)

Use this position when starting the engine or parking the car.

Never use P while car is in motion.

The transmission is mechanically locked when in position P. Also use the parking brake when parking on grades.

The gear selector is locked in the P position (Shift lock). To release the selector, start the engine and depress the brake pedal. See page 6:19 for instructions on manually releasing the gear selector.

CAUTION:

- Never select P or R while the car is in motion.
- When initially selecting positions D, 3, L or R, your right foot should press firmly on the brake pedal to ensure that the car is standing still with the engine idling.
- The gear selector should not be downshifted to L at speeds above 75 mph (125 km/h).*

* Always observe posted speed limits!

WARNING!

Never leave the car when the engine is running. If, by mistake, the gear selector is moved from P the car may start moving.

R (Reverse)

Never engage R while is moving forward.

N (Neutral)

Neutral position = no gear is engaged. Use parking brake. The engine can be started with the gear selector in this position.

D (Drive)

D is the normal driving position and should be used as often as possible to help improve fuel economy. When modes E or S are selected, upshift and downshift of the forward gears occur automatically and are governed by accelerator pedal position and vehicle speed.

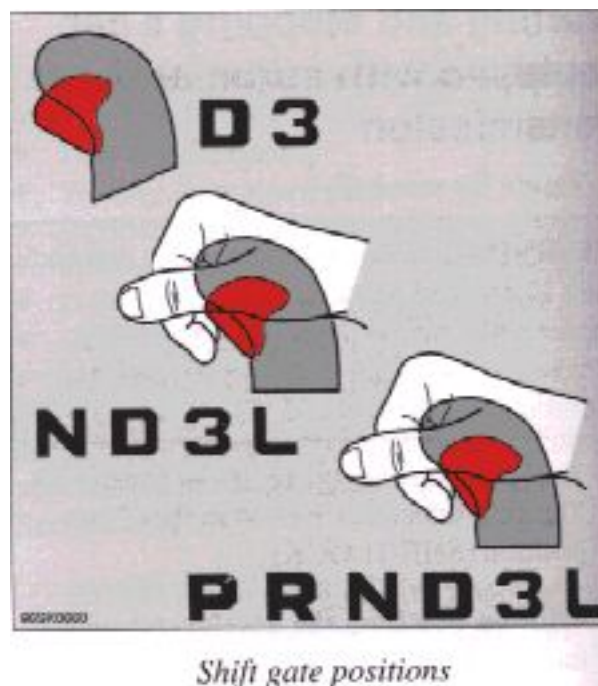

3 (Intermediate position)

Automatically shifts up and down between first second and third gears when driving mode E or S. There is no upshift from third gear. Position 3 can be used for driving in hilly terrain, for towing trailers or for increased engine braking power.

L (Low gear)

No upshift can occur when L is engaged. Select position L for driving in first and second gears. Use this position to select low gear with no upshift, e.g. when ascending and descending steep grades.

pg. 4:7 Automatic transmission AW 30/4 (cont.)

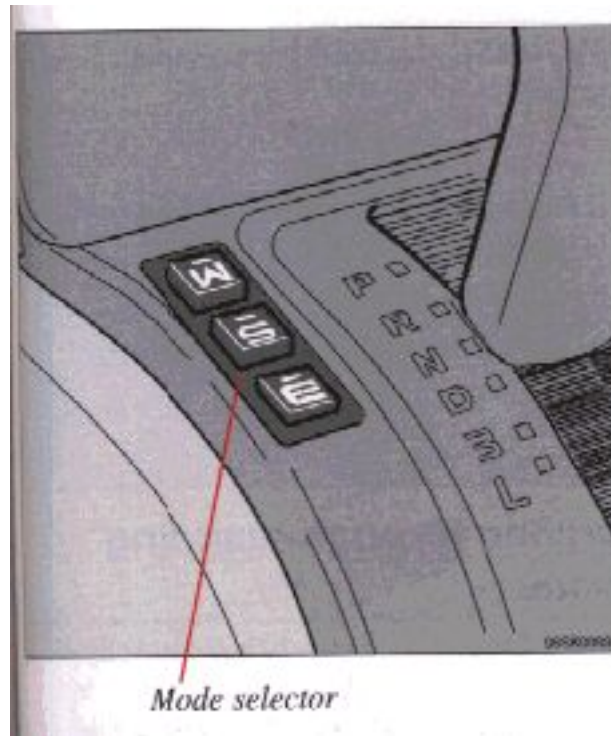

Shift gate positions

The gear selector can be moved freely between D and 3. Selections of other positions are obtained by depressing the selector knob prior to moving the selector.

Slightly depressing the selector knob allows selection of positions N, D, 3 and L. Fully depressing the selector knob allows selection of positions R and P. This is also necessary when initially bringing the selector out of position P. Fully depressing the selector knob thus permits shifting freely between all positions.

Kick-down

Automatic shift to a lower gear (kick-down) is achieved by depressing the accelerator pedal fully and briskly.

An up-shift will be achieved when approaching the top speed for a particular gear or by releasing the accelerator pedal slightly. Kick-down can be used for maximum acceleration or when passing at

highway speeds.

Mode selector

The push-buttons to the left of the gear lever are for selection of modes E, S and W. Any mode can be selected while the car is on the move.



Economy Mode

This mode is used normally. The gearbox changes gears at a lower engine speed to achieve the best possible fuel consumption.



Sport Mode

This mode is adapted to "sporty" driving characteristics. The gearbox changes up and down at higher engine speeds to as to offer maximum performance.



Winter Mode

This mode may be selected for starting/moving off on slippery roads or to lower downshift speeds if the transmission is in "L".

Mode W

* In position D, the gearbox starts in third gear and changes up to fourth gear.

* In position 3, second gear is locked and there is no change up to third gear.

In position L, first gear is locked.

* These positions always offer the kick-down facility.

CAUTION: Driveability and fuel economy will be adversely affected by prolonged driving in mode W. Volvo recommends using this mode only when starting in extremely slippery conditions.

The indicator lamp in the instrument  panel lights up when mode W is selected. Press button W in order to disengage the Winter mode.

When mode W is disengaged, the gearbox automatically reverts to the previously selected S or E mode.

If the indicator lamp  begins to flash, this is an indication of a fault in the automatic gearbox. Please contact your Volvo retailer if this occurs.

"Lock-up"

The automatic gearbox has a "lock-up" function. It reduces engine speed and saves fuel. The principle of "lock-up" is based on the fact that the gearbox's torque converter is disengaged for changes between 3rd, 3rd and 4th gears. The "lock-up" function can sometimes be felt as an additional gearchange.



[Contents](#) | [Top of Page](#)

Three-way catalytic converter cautions

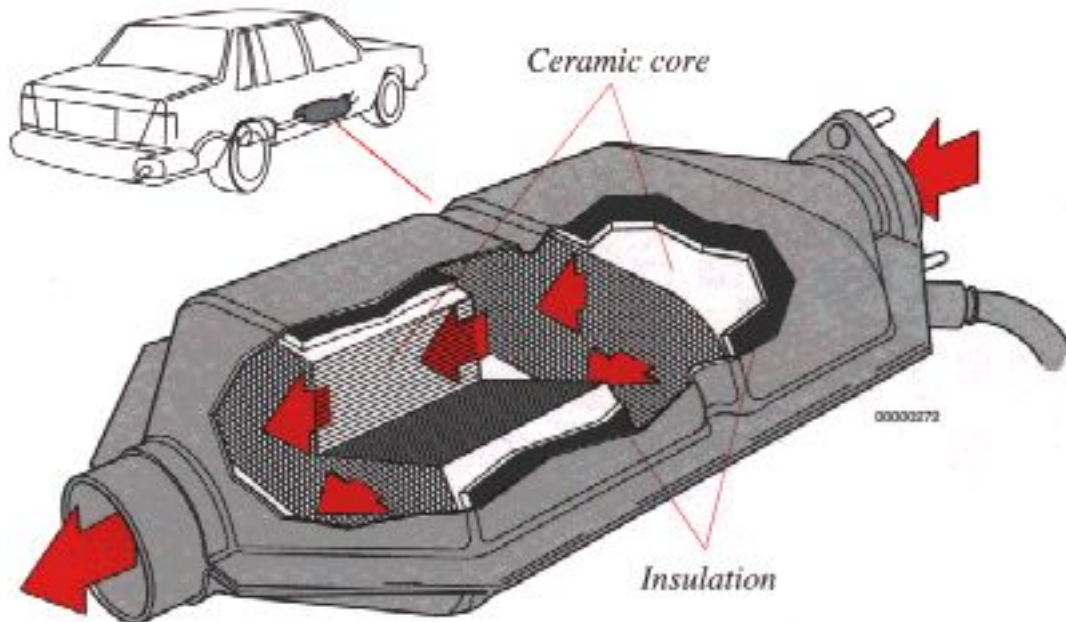

- Keep your engine properly tuned. Certain engine malfunctions, particularly involving the electrical, fuel or distributor ignition systems, may cause unusually high three-way catalytic converter temperatures. Do not continue to operate your vehicle if you detect engine misfire, noticeable loss of power or other unusual operating conditions, such as engine overheating or backfiring. A properly tuned engine will help avoid malfunction that could damage the three-way catalytic converter.
- Remember that tampering or unauthorized modification to the engine or the vehicle may be illegal and can cause three-way catalytic converter or exhaust system overheating. This includes:
 - Altering fuel injection settings or components. Adjusting distributor ignition timing beyond specified limits.
 - Altering emission system components or location or removing components
 - Repeated use of leaded fuel.
- Do not park your car over combustible materials, such as grass or leaves, which can come into contact with the hot exhaust system and cause such materials to ignite under certain wind and weather conditions.
- Excessive starter cranking (in excess of one minute), with an intermittently firing or flooded engine, can cause three-way catalytic converter or exhaust system overheating.

NOTE: Unleaded fuel is required for cars with three-way catalytic converters. A label on the instrument panel and inside fuel tank filler door will remind owners and filling station attendants of this requirement.

Important! It is unlawful to dispense leaded fuel into any vehicle labeled "unleaded gasoline only".

pg. 4:15 Brake system



If one of the brake circuits should malfunction, the red warning light will come on

The pedal stroke increases slightly, the pedal feels softer and extra pressure is required for normal braking.

If the light comes on while driving or braking, stop immediately and check the brake fluid level in the reservoir.

WARNING!

If the fluid level is below the MIN mark in either section of the reservoir: DO NOT DRIVE. Tow the car to a Volvo retailer and have the brake system checked and repaired.

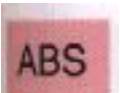

Anti-lock Brake System - ABS

If the warning lamp lights up there is a malfunction of the ABS system (the standard braking system will however function) and the vehicle should be driven to a Volvo retailer for inspection.

The Anti-lock Braking System (ABS) helps to improve vehicle control (stopping and steering) during severe braking conditions by limiting brake lock-up. When the system "senses" impending lock-up, braking pressure is automatically modulated in order to help prevent lockup, which could lead to a skid. The system performs a self-diagnostic test when the vehicle is started and at 4 mph (6 km/h). The driver may detect on pulsation of the brake pedal, which is normal.

To obtain optimal effect from the ABS system, constant pressure should be kept on the brake pedal while the system is modulating the brakes.

The switching of the ABS modulator will be audible at this time.

Please be aware that ABS does not increase the absolute braking potential of the vehicle.

While control will be enhanced, ABS will not shorten stopping distances on slippery surfaces.

Moisture on brake discs and brake pads affects braking.

Driving in rain and slush or passing through an automatic car wash can cause water to collect on the brake discs and pads. This will cause a delay in braking effect when the pedal is depressed. To avoid such a delay when the brakes are needed, depress the pedal occasionally when driving through rain, slush etc. This will remove the water from the brakes. Check that brake application feels normal. This should also be done after washing or starting in very damp or cold weather.

Severe strain on the brake system

The brakes will be subject to severe strain when driving in mountains or hilly areas or towing. The speed is usually low which means that the cooling of the brakes is less efficient than when driving on level roads. To reduce the strain on the brakes it is advisable not to use the brakes excessively. Instead, shift into a lower gear, position 3 or in some cases L, and let the engine help with the braking. Do not forget that, if you are towing a trailer, the brakes will be subjected to greater load than is normal.

If the brake power-assist does function

The power assist to the brakes functions only when the engine is running. When the car is moving without the engine running the brake pedal pressure required to stop the car is increased by 3-4 times. The brake pedal feels stiff and hard.

pg. 4:16 Trailer towing

When preparing for trailer towing, observe the following:

- Use a trailer hitch which meets Federal Safety Standards for rear end collisions (FMVSS 301-75). For trailer weights exceeding 2000 lbs (908 kgs) use only a trailer hitch offered as a Genuine Volvo Accessory.

NOTE: Models with automatic transmission are equipped with a transmission oil cooler as standard equipment. This cooler helps prevent overheating of the transmission during times of increased load, as when towing a trailer.

- Maximum trailer weight recommended by Volvo is:

Trailers without brakes : 1540 lbs (700kg)

Trailers with brakes: 2" ball - 3300 lbs (1500 kg), 1 7/8" ball - 2000 lbs (908 kg).

Observe legal requirements of the state in which the vehicles are registered.

WARNING! Bumper-attached trailer hitches must not be used on Volvos, nor should safety chains be attached to the bumper. Trailer hitches attaching to the vehicle rear axle must not be used.

WARNING! Never connect a trailer's hydraulic brake system directly to the vehicle brake system, nor a trailer's lighting system directly to the vehicle lighting system. Consult your nearest authorized Volvo retailer for correct installation.

All Volvo models are equipped with energy-absorbing shock-mounted bumpers. Trailer hitch installation should not interfere with the proper operation of this bumper system.

Trailer towing does not normally present any particular problems, but take into consideration: The rear suspension incorporates "Nivomat", an automatic level regulating system to compensate for load variations. The system operates when the vehicle is in motion. The rear of the vehicle will however droop if for instance you are carrying a lot of luggage in the trunk or if the vehicle is hitched to a trailer; but as soon as you start driving, the "Nivomat" system will raise the rear of the vehicle to the most suitable level.

- Recommended hitch tongue load is 110 (50 kgs) for trailer weights below 2,650 lbs (1,200 kgs) and 165 lbs (75 kgs) for trailer weights above 2,650 lbs (1,200 kgs).
- For trailer weights between 2,650-3,300 lbs (1,200-1,500 kgs) a top speed of 50 mph (80 km/h) should never be exceeded.
- Increase tire pressure to recommended full-load pressure. See section "Wheels and tires".
- Engine and transmission are subject to increased loads. Therefore, engine coolant temperature should be closely watched when driving in hot climates or hilly terrain. Use lower gear and turn off air conditioner if temperature gauge pointer enters the red range.
- Avoid overload and other abusive operation.
- Hauling a trailer affects handling, durability, and economy.
- It is necessary to balance trailer brakes with the towing vehicle brakes to provide a safe stop (check and observe State/Local regulations).
- Do not connect the trailer's brake system directly to the vehicle's brake system.
- More frequent vehicle maintenance is required.
- Remove the ball and drawbar assembly when the hitch is not being used,
- Volvo recommends the use of synthetic engine oil when towing a trailer over long distances or in mountainous areas.
- The trailer hitch tongue load (110/165 lbs - 50/75 kg) is part of the vehicle's capacity weight. It may be necessary to reduce the trunk/cargo area load when towing a trailer to ensure that the max. permissible axle load or gross vehicle weight are not exceeded.

NOTE: Refer to section "Automatic transmission" for additional trailer hauling tips.

pg. 4:17 Winter driving

Cold weather precautions

- If you wish to check your car before the approach of cold weather, the following advice is worth noting:
Make sure that the engine coolant contains at least 50 percent antifreeze: that is, 5.3 qts. (5 liters) Volvo Genuine Coolant/Antifreeze. This gives protection against freezing down to -31°F (-35°C). See section "Coolant".
The use of "recycled" antifreeze is not approved by Volvo. Different types of antifreeze may not be mixed.
- Try to keep the fuel tank well filled - this prevents the formation of condensation in the tank. In addition in extremely cold weather conditions it is worthwhile to add fuel line de-icer before refueling.
- The viscosity of the engine oil is important. Oil with low viscosity (thinner oil) improves cold-weather starting as well as decreasing fuel consumption while the engine is warming up. For winter use, 5W-30 oil, particularly the synthetic type, is recommended.
Be sure to use good quality oil but do not use this cold-weather oil for hard driving or in warm weather. See section "Engine oil" for more information.
- The load placed on the battery is greater during the winter since the heater, windshield wipers, lighting etc. are used more often. Moreover, the capacity of the battery decreases as the temperature drops. In very cold weather, a poorly charged battery can freeze and be damaged. It is therefore advisable to check the state of charge more frequently and spray an anti-rust oil on the battery posts.
- To prevent the washer reservoir from freezing, add washer solvents containing antifreeze. This is important since the dirt is often splashed on the windshield during winter driving, thus requiring frequent use of the washers and wipers.
- The Volvo Washer Solvent should be diluted as follows:
Down to 14°F (-10°C): 1 part anti-freeze and 4 parts water
Down to 5°F (-15°C): 1 part anti-freeze and 3 parts water
Down to 0°F (-18°C): 1 part anti-freeze and 2 parts water
Down to -18°F (-28°): 1 part anti-freeze and 1 part water
- Use Volvo Teflon lock spray or grease in the locks.

NOTE: Avoid the use of de-icing spray as they can cause damage to the locks.

Automatic differential lock (certain models)

The differential automatically locks at speed between 3 - 25 mph (5 - 40 km/h) if either of the drive wheels begins to lose traction. The differential lock improves power distribution to the drive wheels in slippery conditions, shifting power to the wheel with best traction. It also functions when the transmission is in reverse.

pg. 4:18 Long distance trip

Before a long distance trip

It is always worthwhile to have your car checked at a Volvo retailer before driving long distances. Your retailer will also be able to supply you with bulbs, fuses, spark plugs and wiper blades for your use in the event that problems occur.

If you prefer to check the car yourself, please note the following:

- Check that the engine runs smoothly and that fuel consumption is normal.
- Check engine oil, coolant levels, and for possible fuel leakage.
- Check transmission oil level and rear axle for leakage.
- Check condition of drive belts.
- Check state of charge of battery.
- Examine tires carefully (the spare tire as well), and replace those that are worn. Check tire pressures.
- The brakes, front wheel alignment, and steering gear should be checked by your Volvo retailer only.
- Check all lights, including high beams.
- Reflective warning triangles are legal requirement in some countries.
- Have a word with your Volvo retailer concerning engine adjustments if you intend to drive in countries where it may be difficult to obtain correct fuel.

City Driving

City driving can be a severe driving condition. Low operating speeds, long periods of idling combined with high operating temperatures. Air conditioning usage, etc. will make necessary more frequent servicing (at least every third month).

pg. 4:19 Vehicle storage

If you do not intend to use your car for a long time

The following points may be of use if you do not intend to use your car for a long time (e.g. because of a long holiday, winter, etc.)

- Fill fuel tank to prevent water from condensing inside the tank.
- Wash the car carefully and wax it to protect the paint, don't forget the chromed parts.
- The vehicle should be left in a dry, well ventilated garage.
- Do not apply the hand brake. Block the wheels instead.
- Disconnect the the battery.
- Lift the wiper arms away from the windshield.
- Increase the tire pressure to maximum allowed, i.e. 36 psi.
- Open one of the windows slightly for ventilation.
- Ensure that the coolant contains sufficient anti-freeze to provide protection down to -22°F (-30°C).
Volvo Genuine Coolant/Anti-freeze also provides resistance against corrosion.
- Remove all valuables and lock the car.
- Keep the battery fully charged.



[Contents](#) | [Top of Page](#)

"Special Tips"

- For steep hills and when driving for prolonged periods at low speeds, position L should be selected. Avoid, however, repeated changes since this can cause overheating of the transmission oil. For driving on long continuous uphill gradients, select position 3.
- Select position L when descending long, steep downgrades and position 3 for less steep downgrades, in order to obtain the best possible engine braking effect.
- Do not hold the car stationary on an incline by using the accelerator pedal. Instead, apply the hand brake (parking brake). This prevents the transmission oil from becoming overheated.
- When towing a trailer, select shift position 3.
- The (E)conomy mode should be selected when the cruise control is engaged.

Cooling system

The risk for overheating is greatest, especially in hot weather, when:

- towing a trailer up steep inclines for prolonged periods at wide open throttle and low engine rpm.
- stopping the engine suddenly after high speed driving (so-called "after-boiling" can occur).

To avoid overheating, the following rules should be followed:

- Reduce speed and downshift when towing a trailer up long, steep inclines. The risk of overheating can be reduced by switching off the air conditioning system for a short time.
- Do not let the engine idle unnecessarily for prolonged periods.
- Do not mount auxiliary lamps in front of the grill.

When the risk of overheating is imminent, or in the event of overheating, (the temperature gauge goes repeatedly into, or stays continually in, the red section) the following precautions should be taken:

- Switch off the air conditioning system.
- Stop the car and put the gear lever into neutral. Do not stop the engine!
- If the vehicle is overheating, switch the heater to full (maximum) position.
- Increase the engine speed to approx. 2000 rpm (twice idling speed).
- Check the level of coolant in the expansion tank. Top-up, if necessary. See "Cooling System".

The engine must NOT be running when coolant is topped-up.

WARNING! Do not drive with trunk lid or tailgate open!

Poisonous exhaust gases may enter via the trunk lid or tailgate.

If the trunk lid/tailgate must be kept open for any reason, proceed as follows:

- Close the windows.
- Set the ventilation system control to  and blower control to its highest setting.

Driving through standing water

CAUTION: Drive slowly and carefully if going through standing water (i.e. flooded roadways, etc.).

Damage to engine could result if excess water is ingested through the air intake system.

Never drive the vehicle in water deeper than 1 foot (300 mm).

pg. 4:9 Points to remember (cont.)

Electrical system

When replacing the battery or when carrying out work involving the electrical system, the following should be observed:

- A battery connection to the wrong terminal will damage the diodes. Before connections are made, check the polarity of the battery with a voltmeter.
- If booster batteries are used for starting, they must be properly connected to minimize the risk of the diode being damaged.

For correct connection, see "Jump starting" section.

- Never disconnect the battery circuit (for example, to replace the battery) while the engine is running, as this will immediately ruin the generator. Always make sure that all the battery connections are properly tightened.
- If any electrical-welding work is performed on the vehicle, the battery's ground lead (negative cable) and all the connecting cables of the generator must be disconnected and the welder cables placed as near the welding point as possible.
- The radio must be turned off before the battery is disconnected.
- If the radio has an anti-theft code and the battery has been disconnected, the code must be re-entered before the radio will function properly.

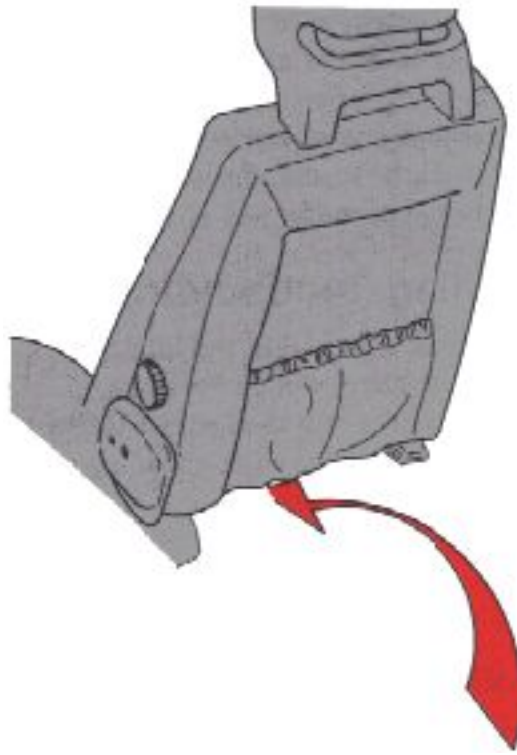

WARNING!

The Supplemental Restraint System is grounded under the driver's seat. Do not loosen the two screws grounding the unit. Do not ground other electrical components using these screws or any other points near them. Faults in the system could occur if it is improperly grounded.

pg. 4:10 Points to remember

Weight distribution affects handling

At the specified curb weight your car has a tendency to understeer, which means that the steering wheel has to be turned more than might seem appropriate for the curvature of a bend. This ensures good stability and reduces the risk of rear wheel skid. Remember that these properties can alter with the vehicle load. The heavier the load in the trunk, the less the tendency to understeer.

Handling, roadholding

Vehicle load, tire design, and inflation pressure, all affect vehicle handling. Therefore, check that the tires are inflated to the recommended pressure according to the vehicle load. See "Tire pressure" section. Loads should be distributed so that capacity weight or maximum permissible axle loads are not exceeded.

WARNING! It is recommended that tire of the same make and dimensions be used on all four wheels (including the use of snow tires). Do not use bias ply tires as this will adversely alter vehicle handling characteristics.

WARNING!

An extra mat on the driver's floor can cause the accelerator pedal to catch. Check that the movement of the accelerator pedal is not impeded. Not more than one protective floor covering may be used at one time.

Roof racks (removable and permanent)

Roof racks are available as Volvo accessories. Observe the following points when is use:

- Avoid single-point loads. Distribute the load evenly.
- Place heavier cargo at bottom of load.
- Observe that center of gravity and handling are influenced by load weight.
- Increasing load size increases wind resistance and, thus, adversely affects fuel economy.
- Anchor the cargo correctly with appropriate tie-down equipment.
- Drive carefully. Avoid rapid starts, fast cornering and hard braking.
- Max. roof load is 220 lbs. (100 kg) for removable racks mounted on drip rails.
- Max roof load is 70 lbs (30 kg) for permanent rack mounted directly on roof.

pg. 4:11 Emergency towing (pulling of vehicles)

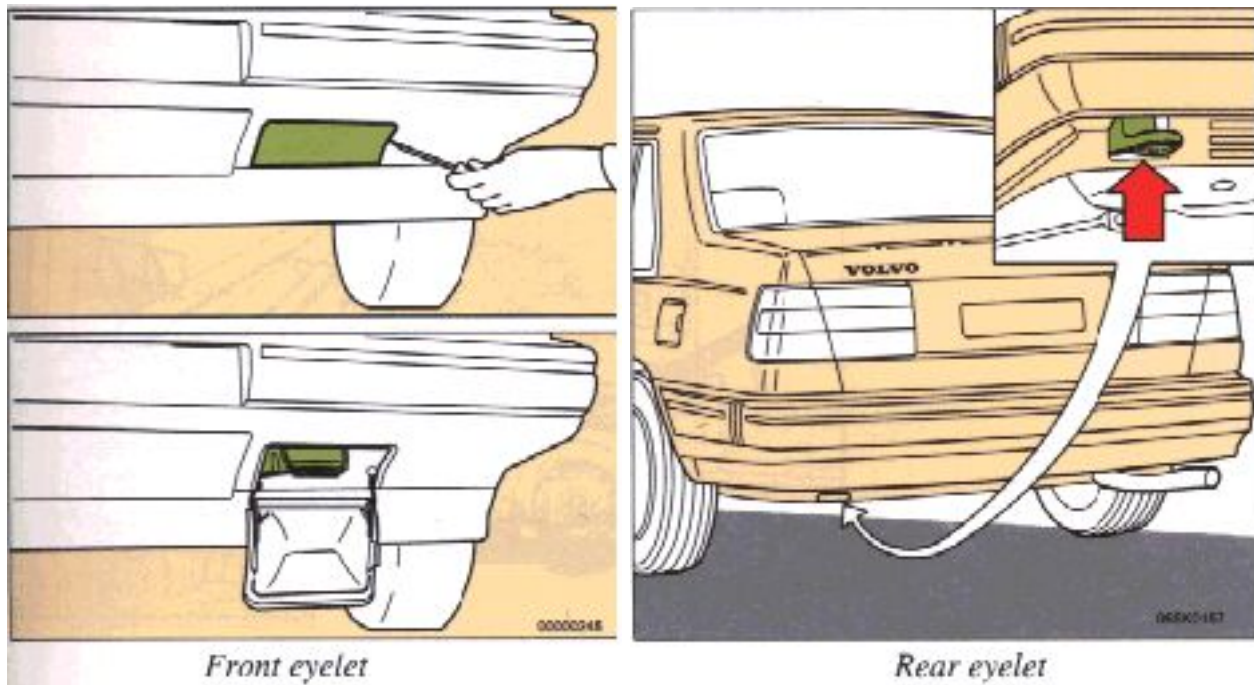

Precautionary steps to observe when car is in tow

- Steering must be unlocked.
- Please check with state and local authorities before attempting this type of towing, as vehicles being towed are subject to regulations regarding maximum towing speed, length and type of towing device, lighting, etc.
- Remember that power brake and power steering assists will not be available when engine is inoperative. Brake pedal pressure required is 3 - 4 times above normal and greater steering effort must be exerted.
- Gear selector in position N. Check transmission oil level (see section titled "Transmission oil").
- Maximum speed: 20 mph (30 km/h).
- Maximum distance with rear wheels on ground: 20 miles (30 km).
- If the battery is dead, it is not possible to release the gear selector by pressing the brake pedal. Release the gear selector manually, see page 6:19.

Cars equipped with automatic transmission/three-way catalytic converters cannot be started by pushing or pulling the car.

CAUTION: The towing eyelets must not be used for pulling another vehicle out of a ditch or any similar purpose involving severe strain.
Do not attempt to start the car by pushing or pulling it as damage to the three-way catalytic converter can result.

pg. 4:12 Vehicle towing information

Only use wheel lift or flat bed equipment.

CAUTION:

Sling-type equipment applied at the front will damage radiator and air conditioning lines. It is equally important not to use slingtype equipment inside the rear wheels: serious damage to the rear axle may result.

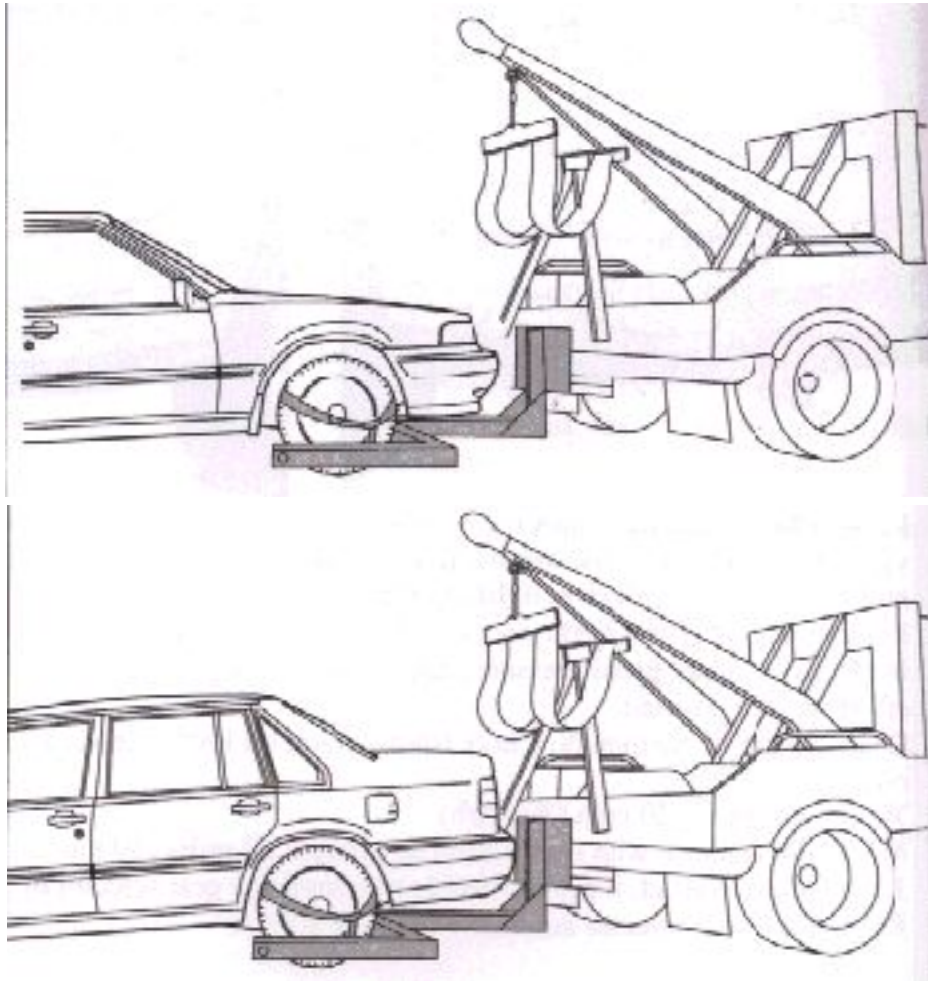

pg. 4:13 Jump starting

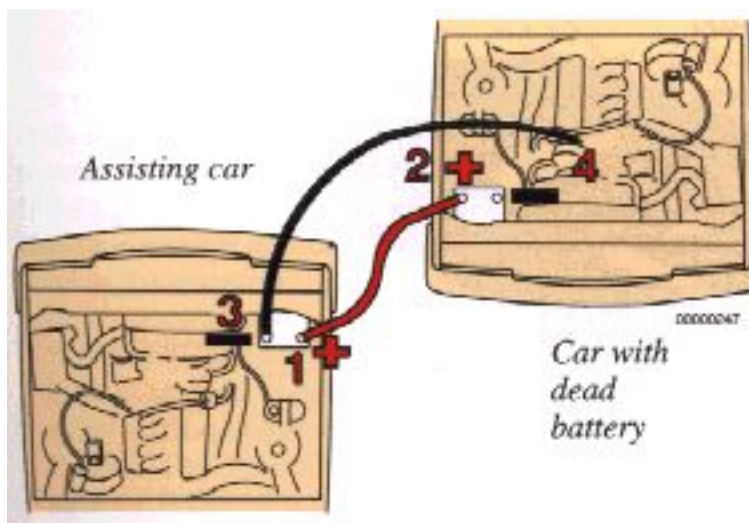

CAUTION: Improper hook-up of jumper cables or use of other than 12-volt batteries could result in damage to equipment and/or battery.

Check that cars are not touching to prevent premature completion of negative circuit. Note the position of the battery terminals and using jumper cables, first connect booster battery positive (+) terminal (1) to car battery positive (+) terminal (2). Then connect booster battery negative (-) terminal (3) to a stationary solid metal part on the engine at a point away from the battery (4).

Do not connect booster cable to any part of fuel system or any moving parts. Avoid touching hot manifolds. After engine has started, remove first the negative (-) terminal jumper cable. Then remove the positive (+) terminal jumper cable.

WARNING!

To reduce the possibility of explosion, never expose battery to open flame or electric spark. Do not smoke near battery. Batteries generate hydrogen gas which is flammable and explosive. Battery fluid contains sulfuric acid. Do not allow battery fluid to contact eyes, skin, fabrics or painted surfaces. If contact occurs, flush affected area immediately with water. Obtain medical attention immediately if eyes are affected.

WARNING!

Failure to follow the instructions of jump starting can lead to personal injury.



[Contents](#) | [Top of Page](#)

Wheels and tires

pg. 5:1 Wheels and tires

Wheels and tires

The handling and riding comfort of the vehicle is dependent on the inflation pressure and the type of tires fitted. Read the following pages carefully.

[5:2](#) General information

[5:3](#) Tread wear indicators

[5:4](#) Inflation pressure

pg. 5:2 Wheels and tires

General information

Your vehicle is equipped with 195/65R15 tires.

The tire designation is coded as follows:

195 = tire width in mm.

60 = tire profile. This is the relationship (in percent) between the section height and the width of the tire.

R = radial tires.

15 = diameter in inches on all four wheels.

Wheels - 6" x 15" Aero Alloy

The tires have good road holding characteristics and offer good handling on dry and wet surfaces. It should be noted however that the tires have been developed to give these features on snow/ice-free surfaces. For optimum road holding on icy or snow covered roads - we recommend suitable winter tires. When replacing tires, be sure that the new tires are the same size designation, type (radial) and preferably from the same manufacturer, on all four wheels. Otherwise there is a risk of altering the car's road-holding and handling characteristics.

NOTE: When storing wheel/tire assemblies (e.g. winter tires and wheels), either stand the assemblies upright or suspend them off the ground. Laying wheel/tire assemblies on their sides for prolonged periods can cause wheel and/or tire damage.

Snow chains

Snow tire chains can be used on your Volvo with the following restrictions:

- Snow chains should be installed on rear wheels only.
- Snow chains can be used on the tires and wheels provided as original production equipment with your Volvo.

If accessory, aftermarket of "custom" tires and wheels are installed and are of a different size than the original tires and wheels, chains in some cases **CANNOT** be used. Sufficient clearances between chains and brakes, suspension and body components must be maintained.

- Some strap-on type chains will interfere with brake components and therefore **CANNOT** be used.

CAUTION:

- Check local regulations regarding the use of snow chains before installing.
- Always follow the chains manufacturer's installation instructions carefully. Install chains as tightly as possible and re-tighten periodically.
- Never exceed the chain manufacture's specified maximum speed limit. (Under no circumstances should that limit be higher than 30 mph (50 km/h).
- Avoid bumps, holes or sharp turns when driving with snow chains.
- The handling of the vehicle can be adversely affected when driving with chains. Avoid fast or sharp turns as well as locked wheel braking.

pg. 5:3 Wheels and tires

Wear indicator

The tires have a so-called "wear indicator" in the form of a number of narrow strips running across or parallel to the tread. When approx. 1/16" (1.6 mm) is left on the tread, these strips show up and indicate that the tire should be replaced.

Tires with less than 1/16" (1.6 mm) tread have a very poor grip in rain or snow.

When replacing worn tires, it is recommended that the tire be identical in type (radial) and size as the one being replaced. Using a tire of the same make (manufacturer) will prevent alteration of the driving characteristics of the vehicle.

To improve tire economy:

- Maintain correct tire pressure.

- Drive smoothly: avoid fast starts, hard braking and tire screeching.
- Tire wear increases with speed.
- Do not change wheel location unless necessary.
- Correct front wheel alignment is very important.
- Unbalanced wheels impair tire economy and driving comfort.
- Hitting curbs can damage the tires and/or wheels permanently.

Flat spots

All tires become warm during use. After cooling, when the vehicle is parked, the tires have a tendency to distort slightly, forming flat spots. These flat spots can cause vibrations similar to the vibrations caused by imbalanced wheels.

They do, however, disappear when the tire warms up. The degree to which the flat spots form depends on the type of cord used in the tire. Remember that, in cold weather, it takes longer for the tire to warm up and consequently longer for the flat spot to disappear.

Snow tires, studded tires

Tires for winter use:

Use snow tires fitted to the standard 15" wheels on all four wheels (preferably steel). Do not mix tires of different design, as this could negatively affect overall tire road grip especially during slippery road conditions!

Studded tires should be run-in 300-600 miles (500-1000 km) during which the car should be driven as smoothly as possible to give the studs the opportunity to seat properly in the tires. The car tires should have the same rotational direction throughout their entire lifetime. In other words, if you wish to rotate the wheels, make sure that the same wheels are always on the same side of the car.

NOTE: Regulations governing the use of studded tires may vary from one state or province to another.

WARNING! Special wheel rims for air dams

Only special wheel rims, tested and approved by Volvo, are suitable for use with the air dam installed on the 960.

pg. 5:4 Wheels and tires

Checking and correcting tire pressure

Check the tire pressure when refueling.

The tire pressure should be corrected only when the tires are cold. With warm tires, correct only when the pressure is too low. The tire temperature rises after driving just a few miles.

Vehicle Loading

The tires on your Volvo will perform to specifications at all normal loads when inflated as recommended on the tire information label* located on the rear facing side on the right front door. This label lists both the tire and vehicle design limits. Do not load your car beyond the load limits indicated.

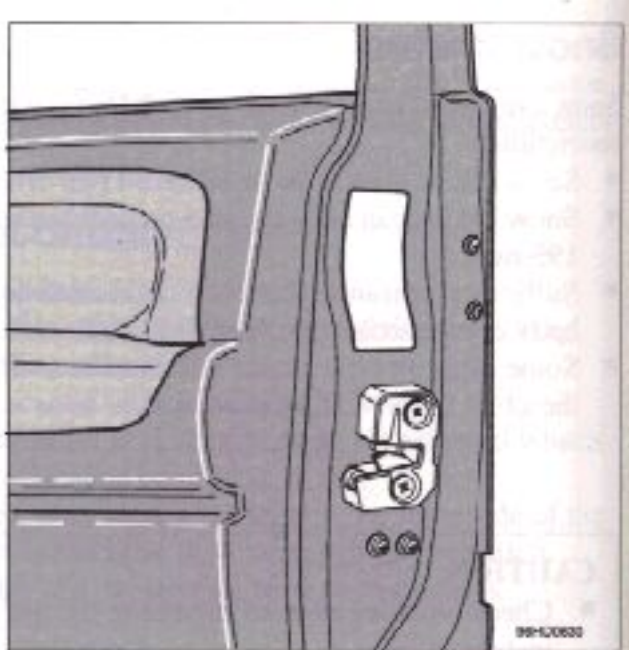

Located on rear edge of right front door

VEHICLE CAPACITY		OCCUPANTS			COLD TIRE PRESSURE	
WEIGHT	FRONT	REAR	TOTAL	FRONT	REAR	PSI
MAX (LOAD)	2	3	5			
RECOMMENDED FOR FUEL ECONOMY						
OPTIONAL TIRE SIZES:						
TIRE SIZE	2	1	3			PSI
* SEE APT FOR TIRE PRESSURE LIMITS AND PSI TO BE MAINTAINED ON LOADS						
	SIZE	WITH DISC	AWAY FROM			PSI
SEE DRIVER'S MANUAL FOR ADDITIONAL INFORMATION						
VOLVO						

(Sample tire pressure label)



[Contents](#) | [Top of Page](#)

In case of emergency

pg. 6:1 In case of an emergency

In case of emergency

Even if you maintain your car in good running condition, there is always the possibility that something might go wrong and prevent you from driving, such as a punctured tire, blown fuse or bulb, etc.. For additional information, see section "ON CALL Road Assistance".

[6:2](#) Changing a wheel

[6:4](#) Special spare tire

[6:5](#) Replacing bulbs

[6:13](#) Replacing fuses

[6:15](#) Replacing wiper blades

[6:16](#) Troubleshooting

pg. 6:2 Wheel changing

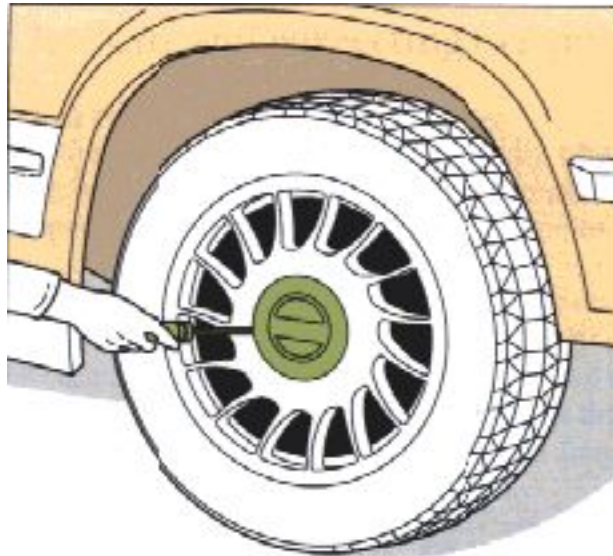

860M0017

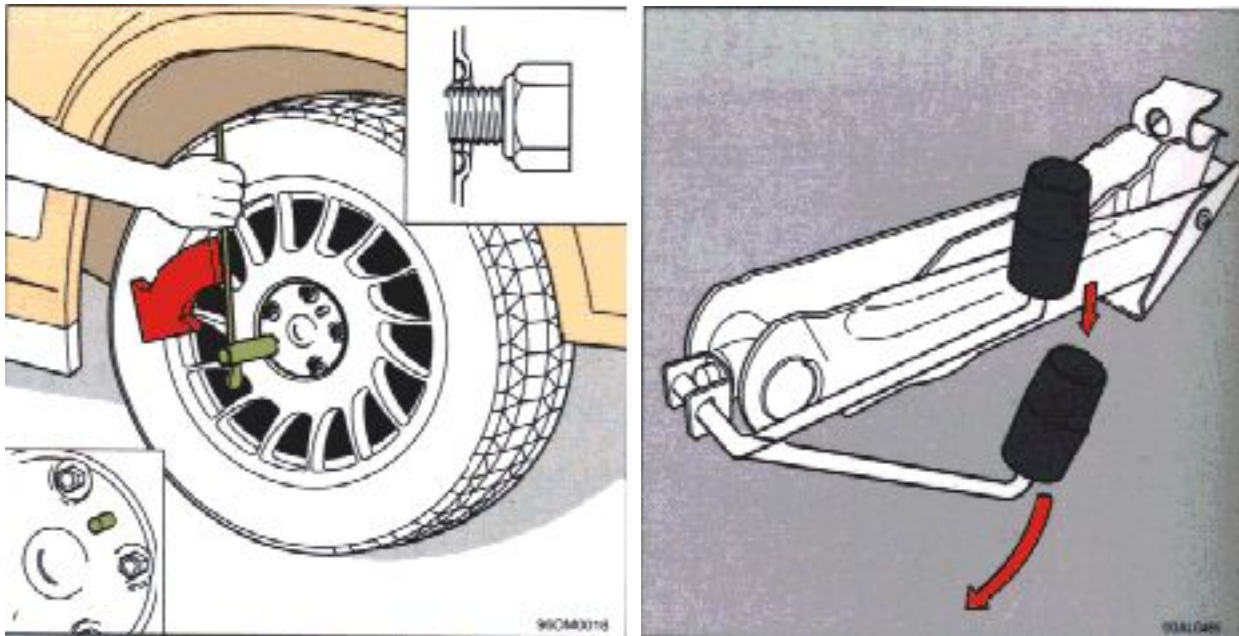

Alternate version of jack

Changing a wheel

On sedans the spare wheel, jack and toolbag are located in the trunk, beneath the carpet. The jack must be completely retracted to fit into the holder.

On wagons, the spare tire and the jack are located beneath the floor mat in the large storage bin. Always secure the spare tire and the jack to prevent them from rattling.

- Remove the wheel cap, using the screwdriver in the tool kit.
- With the car still on the ground, use the box wrench from the tool kit to loosen the wheel nuts 1/2 - 1 turn. Turn the nuts counterclockwise to loosen.

NOTE: The jack in your car comes in two versions. If your car is equipped with the alternate version (see illustration), the crank handle can be folded out by pressing the nob on the handle downward. To attach the jack, refer to the illustration on the following page.

NOTE:
To avoid excessive wear and the necessity of rebalancing, mark and reinstall wheels in same location and position as before removal. To lessen the chance of imbalance, each wheel hub is equipped with a guide stud to ensure that a removed wheel can be reinstalled in its original position (as when changing over to winter tires/wheels).

pg. 6:3 Wheel changing

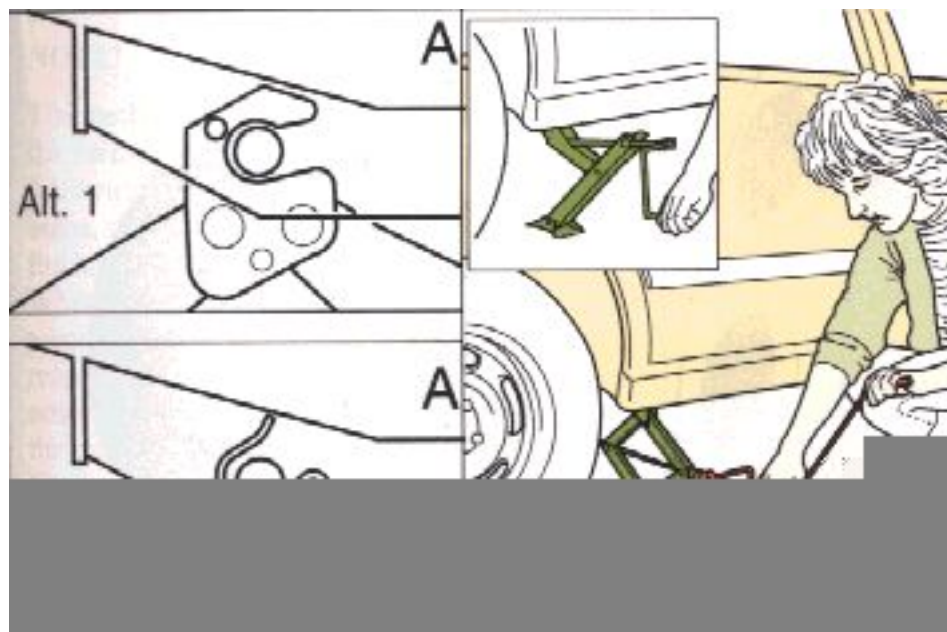

Jack attachment

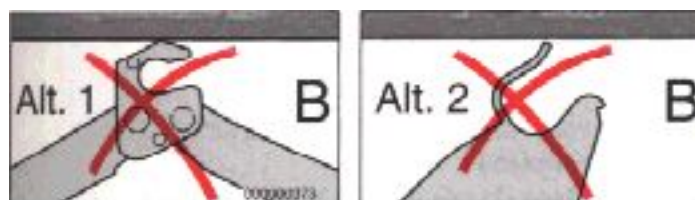

There is a jack attachment adjacent to each wheel location. Hang the jack from the attachment (alt. 1) or position the jack on the bar in the jack attachment (alt. 2) as shown in the illustrations above and crank while simultaneously guiding the base to the ground. The base of the jack must be flat on a level, firm, non-slippery surface. Before raising the car check that the jack is still correctly positioned in the attachment. Now raise the vehicle until the wheel is free of the ground. Unscrew the wheel nuts completely and carefully remove the wheel so as not to damage the thread of the studs.

WARNING!

- The jack's hook must engage the pin in the jack attachment (A). The car's weight must not rest on the jack's hook (B).
- Be sure the jack is on firm and level ground.
- Never allow any part of your body to be extended under a car supported by a jack.
- Use the jack intended for the car when replacing a wheel. For any other job, use stands to support the end of the car being worked on.
- Apply the parking brake, select position P (automatic transmission).
- Block the wheels standing on the ground. Use rigid wooden blocks or large stones.
- The jack should be kept well-greased.

Installing the wheel

Clean the contact surfaces on the wheel and hub. Lift the wheel and place it on the hub. Make sure that you align the wheel with the guide stud on the wheel hub prior to installation. Install the wheel nuts crosswise and tighten lightly. The conical side of the nuts should face the wheel. Lower the vehicle to the ground and alternately tighten the nuts to 63 ft. lbs. (85 Nm). Install the wheel cap.

pg. 6:4 Spare tire

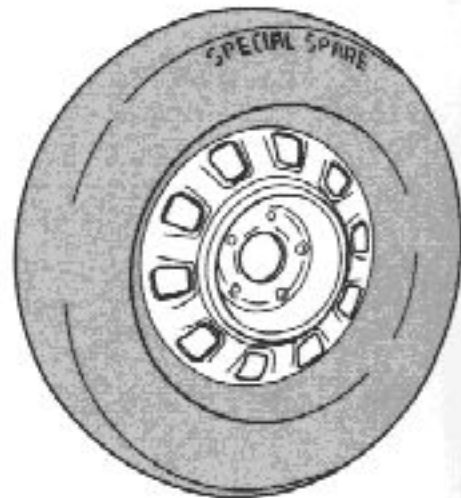
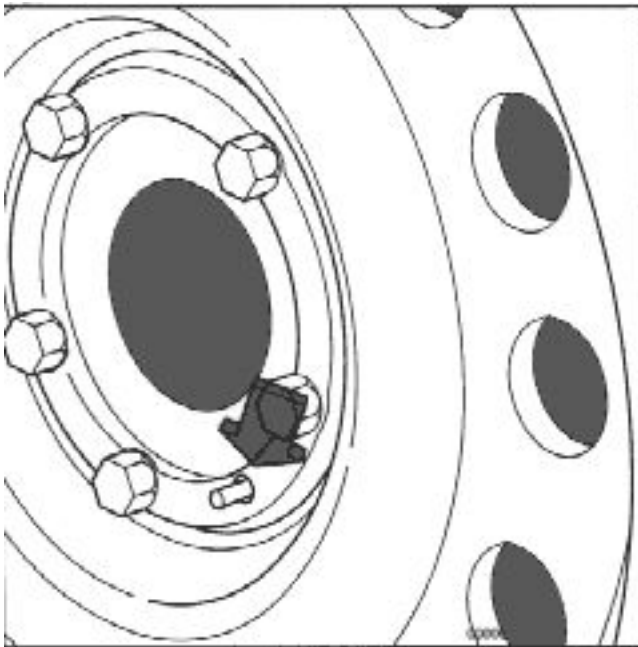

WARNING!

Current legislation prohibits the use of the "Special Spare" tire other than as a temporary replacement for a punctured tire. In other words, it must be replaced as soon as possible by a standard tire. Roadholding, etc., may be affected with the "Temporary Spare" in use. Do not, therefore, exceed 50 mph (80 km/h).

Special Spare

The spare tire of your car is what is called a "Special Spare". This is embossed on the tire. See illustration.

Recommended tire pressure (see decal) should be maintained irrespective of which position of the car the Special Spare tire is used on.

In the event of damage to this tire a new one can be purchased from your Volvo dealer.



[Contents](#) | [Top of Page](#)

Fuses

The easiest way to see if a fuse is blown is to remove it. Refer to the list of fuses on the inside of the fuse box cover to see which one should be examined.

Pull the fuse straight out. From the side, examine the curved metal wire to see if it is broken. If so, put in a new fuse of the same color and amperage (written on the fuse). Spare fuses are stored in a lit compartment in the fuse box:

1 x 15A (blue), 1 x 25A (pale yellow), 1 x 30A (green)

If fuses burn out repeatedly, have the electrical system tested at a Volvo dealer.

If you find it difficult to remove a fuse, you will find a special fuse tool clipped in the fuse box.

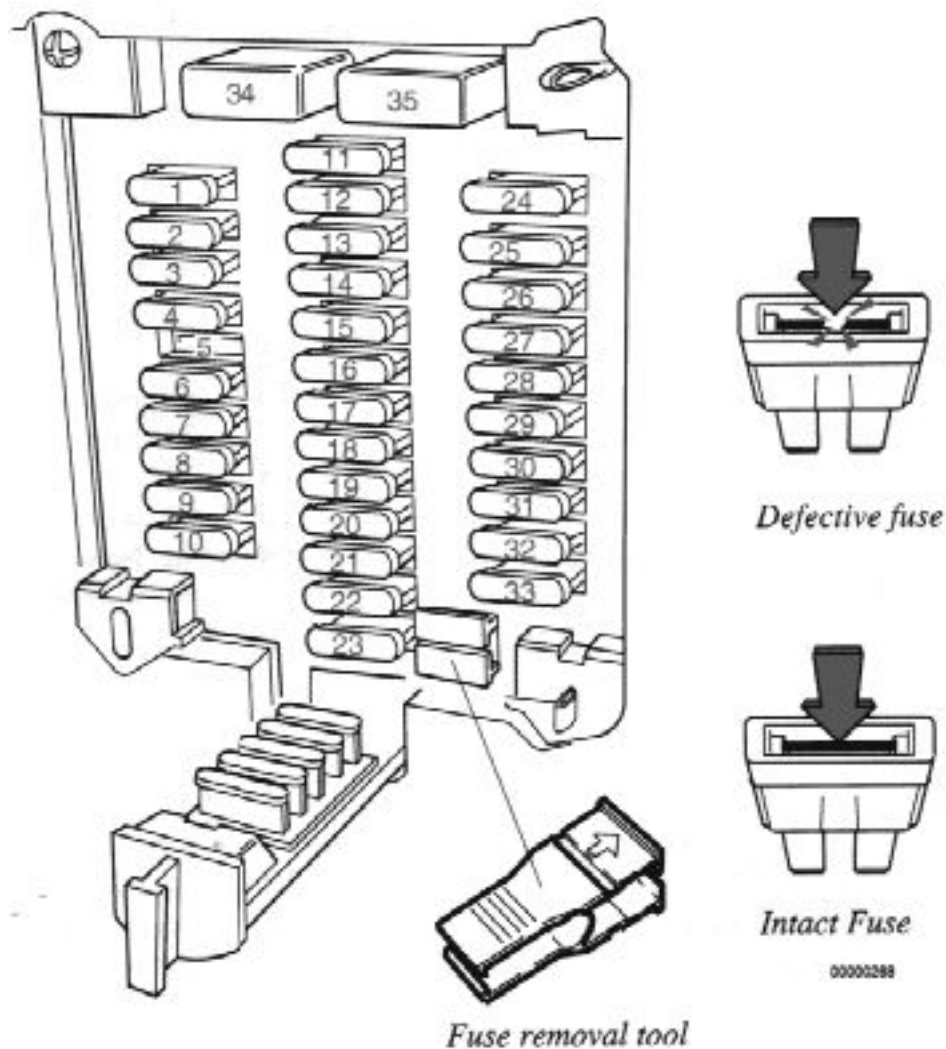

Location* Amperage

- 1 Position lights license plate light 10
- 2 Position lights 10
- 3 Left high beam 15
- 4 Right high beam 15
- 5 -
- 6 Left low beam 15
- 7 Right low beam 10
- 8 Front fog lights 15
- 9 Rear fog light 10
- 10 Instrument/panel lighting 5
- 11 Back-up lights, turn signals, cruise control 15
- 12 Shift lock 15
- 13 Heated rear window, heated side-view mirrors 25
- 14 Overdrive, seat belt reminder, relays for power windows/sunroof/heated seats 10
- 15 -
- 16 Heated seats 30
- 17 -
- 18 Audio system 5
- 19 ECC, rear wiper/washer (wagons), cigarette lighter, power seats, ambient temperature sensor 15
- 20 Windshield wipers/washers, horn 25
- 21 Transmission mode selectors 5
- 22 ABS 15
- 23 Transmission control 10
- 24 Transmission/engine controls 10
- 25 Hazard warning flashers, central locking system 25
- 26 Clock, interior lighting, door open warning lights, cargo space and vanity mirrors 10
- 27 Brake lights, shiftlock 15
- 28 ECC, air conditioning 30
- 29 Power antenna, power to trailer 30
- 30 Fuel pump (tank), heated oxygen sensor 10
- 31 Engine control systems, fuel pump (main) 25
- 32 -
- 33 Audio system 10
- 34 Power windows, power sun roof 30
- 35 Power seats 30

Note: The ABS system is protected by an additional 10 A fuse which is located under the instrument panel to the left of the steering wheel.

Note: Refer to fuse box cover label for your vehicle's specific fuse usage.

Note: Fuses No. 34 and 35 are circuit breakers which activate when overloaded. After 20 seconds, the circuits should have cooled down and function normally.

For more detailed information concerning function and location of relays, fuses, etc., refer to the Volvo Service Manuals. These can be purchased directly using the Service Literature Brochure/Order Form or through your Volvo dealer.

* Some of the equipment/systems listed may be available on certain models only and/or as optional items only.

pg. 6:15 Replacing wiper blades

Replacing wiper blades

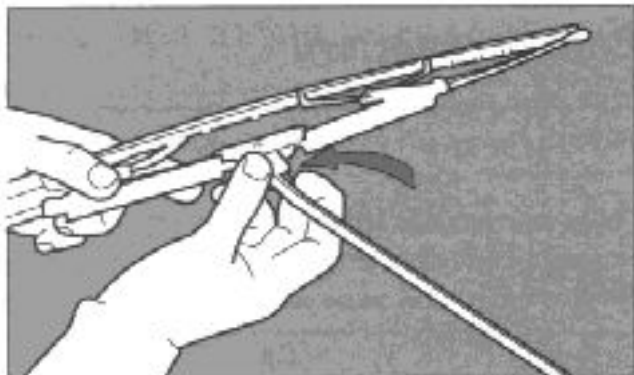

Lift the wiper arm off the windshield and hold blade at right angles to arm. Pinch the end of the plastic clip located at the back of the arm.

Slide the wiper blade along the arm to release it from the hook.

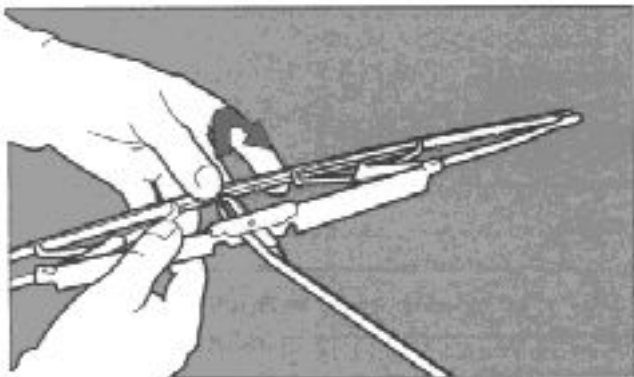

Install new blade (installation is the reverse of removal) and make sure that it is properly attached to the wiper arm.

For reasons of safety, you should change the windshield wiper blades as soon as they start to leave marks on the windshield or fail to wipe efficiently and cleanly.

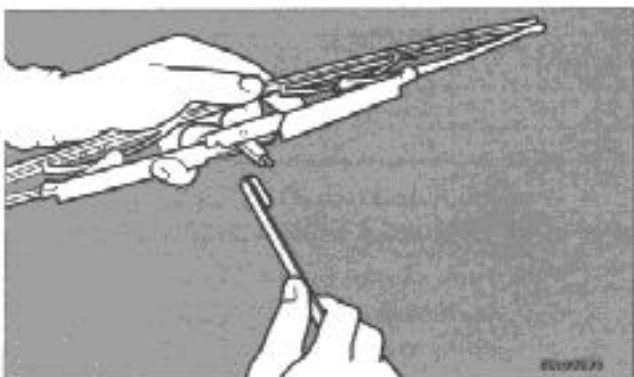

To obtain maximum lifetime from a set of wiper blades, clean them with a stiff-bristle brush and warm, soapy water as part of a normal car wash.

pg. 6:16 Service diagnosis

The diagnoses outlined below are intended to serve only as guides to locate and temporarily correct minor faults. Causes of unsatisfactory performance should be investigated and corrected by your Volvo dealer only. See section "Road Assistance".

Starter fails to operate (or operates very slowly)

Weak battery or dead cell.

With the starting (ignition) switch in the "Driving" or "On" position, check to see if the warning lights on the dashboard come on and if they stay on when the starter is engaged. If the lights do not come on or if they go off when the starter is engaged, the battery is discharged, or see below.

Loose or corroded battery cable terminals.

Check battery terminals and clamps. Clean or replace if necessary. Check that the starter cable is secure at its terminals.

The ground strap, which connects the body to the rear of the engine, should also be checked for corrosion or looseness.

Open circuit between starting (ignition) switch and starting (ignition) switch terminal on starter.

The circuit is closed if a clicking sound is heard from the starter when it is engaged. If no clicking sound is heard, check that the blue wire at the starter is secure. If still no clicking sound is heard, the starting (ignition) switch or the wire is defective.

Starter motor defective.

If the above checks have been performed, and no fault is evident, the starter may be defective.

NOTE: In this case the headlight intensity will not decrease when the starter is engaged.

pg. 6:17 Service diagnosis (cont.)

Starter motor operated but engine does not start

Intake system leaking.

Check vacuum hose connections at manifold and idle air control valve.

No fuel reaching engine.

Check for fuel in the tank.

Check fuses No. 30 and 31.

No spark.

If there is no spark, check that the high tension lead from the coil to the distributor cap is connected and that the wires to the distributor and coil are connected.

If no fault is found following the above steps, contact your Volvo dealer.

Excessive fuel
consumption

Fuel lines leaking.
Check tightness.

Spark plugs worn.
Replace plugs.

pg. 6:18 Service diagnosis (cont.)

Erratic idle
(misfiring)

Intake system leaking.
Check vacuum hose connections to manifold and idle air control valve.

Worn spark plugs.
Remove. Clean or replace spark plugs.

Engine stalls at irregular
intervals

Defective wires.
Check wire terminals at: fuel pump, fuse No. 30 and 31, coil, ignition switch and relays.

Intake system leaking.
Check vacuum hose connections at manifold and idle air control valve.

Fuel filter clogged.
Clean fuel tank filter and replace line fuel filter.

Misfiring at highway driving speed

Spark plugs fouled.

Drive the vehicle in a lower gear and keep the engine rpm higher for a few miles in order to remove carbon deposit on the spark plugs. If this procedure is not effective, clean or replace the spark plugs. Please be aware that misfiring spark plugs can cause damage to the three-way catalytic converter.

pg. 6:19 Service diagnosis (cont.)

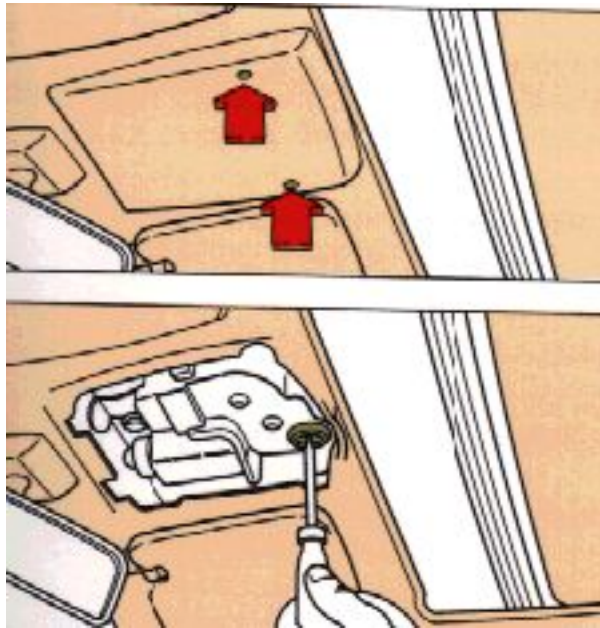

Emergency sun roof operation

If, because of an electrical fault (e.g. a blown fuse), it is not possible to operate the sun roof electrically, then it is possible to operate it manually.

First, using a small screwdriver, remove the two screws that secure the sun roof motor cover to the headliner. Then using a screwdriver, depress the white plastic clutch pin in the center of the motor screw to close or open the roof as desired.

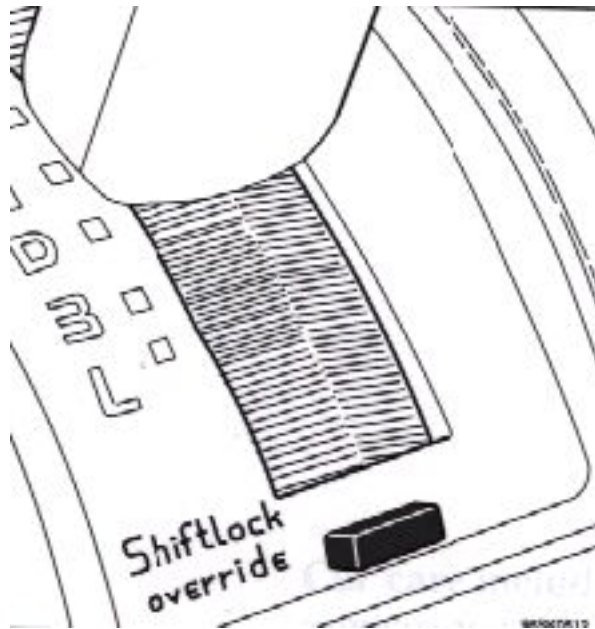

Shiftlock release

The gear selector is locked in the P position. To manually release the shift lock, turn the starting (ignition) key to position I and press firmly on the "SHIFTLOCK OVERRIDE" button located near the base of the gear selector (see illustration). While holding the override button down, move the gear selector from the (P)ark position.



[Contents](#) | [Top of Page](#)

pg. 6:5 Replacing bulbs

NOTE!

The method for replacement of bulbs in the various lighting units is shown on the following pages. Make sure when installing bulbs, that the guide pin on the socket fits into its corresponding recess. When installing Halogen bulbs, do not touch the glass with your fingers because grease, oil or any other impurities can be carbonized onto the bulb and damage the reflector. Use bulbs of correct type and voltage. Failure to do so could cause the bulb failure warning light to activate.

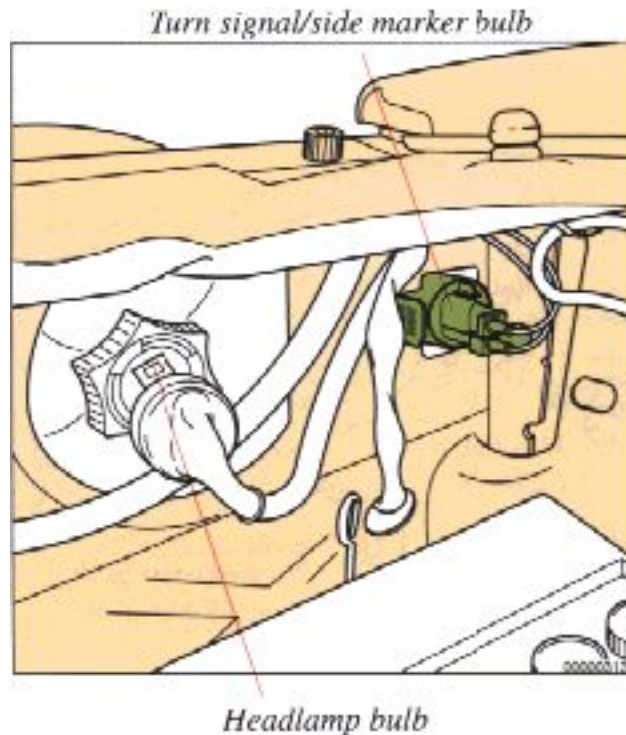
**Headlamps**

- 1 Pull the connector out.
- 2 Loosen the ring by turning it counter-clockwise.
- 3 Pull the bulb straight out.
- 4 Replace the bulb and reinstall the unit in the reverse order.

Bulb Power US Bulb No.

Headlamp (45/65) HB1/9004

Turn signal/parking light/side marker light

- 1 To remove, turn the lamp holder 1/4 turn counter-clockwise.
- 2 Press the bulb in and turn it 1/4 turn counter-clockwise.
- 3 Replace the bulb and reinstall the unit in the reverse order.

Power CP (W) Socket US Bulb No.
24/2.2(21/5) BAY 15d 1157 NA

pg. 6:6 Replacing bulbs

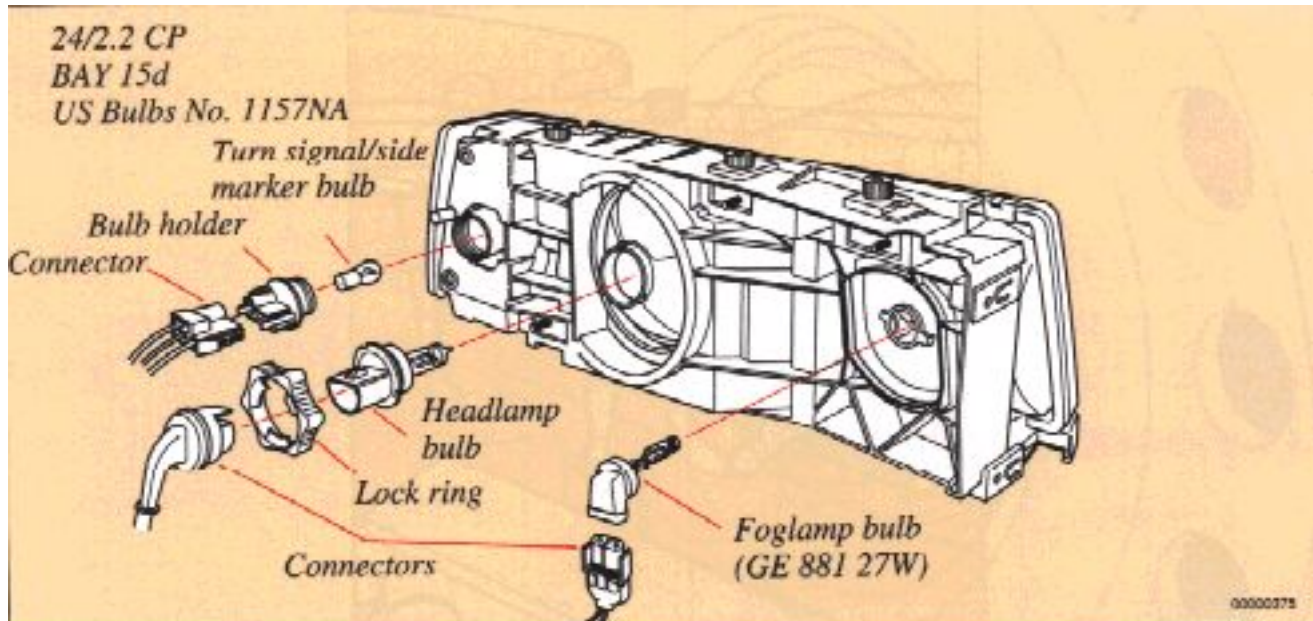

Access to the bulbs is obtained from the engine compartment. Switch off the lights and ignition key.

Note: It may be necessary to remove the washer fluid reservoir fill tube in order to gain access to the bulb holder.

Fog lamps

- 1 Turn the lamp holder 1/4 turn counter-clockwise.
- 2 Remove the bulb from the connector by pushing the catches to the sides.
- 3 Replace the bulb and the holder.

Bulb Power US Bulb No.
Foglamp (27W) GE881

pg. 6:7 Replacing bulbs, Sedans

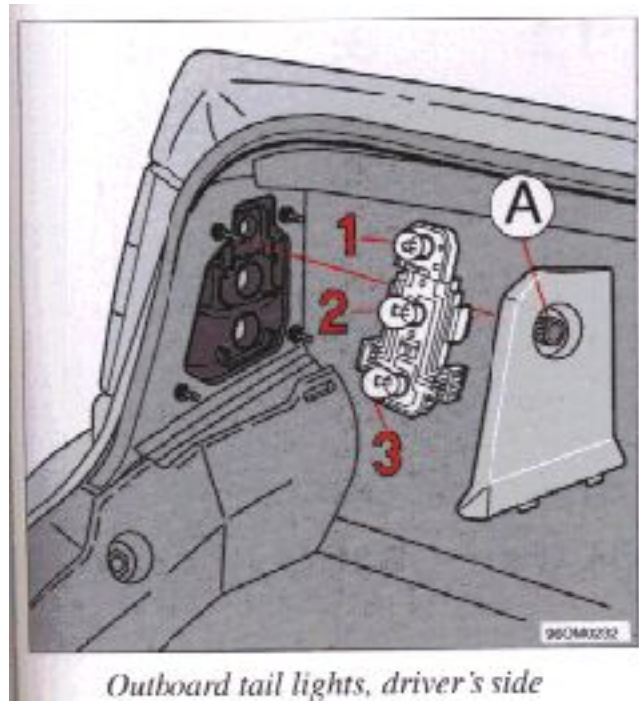
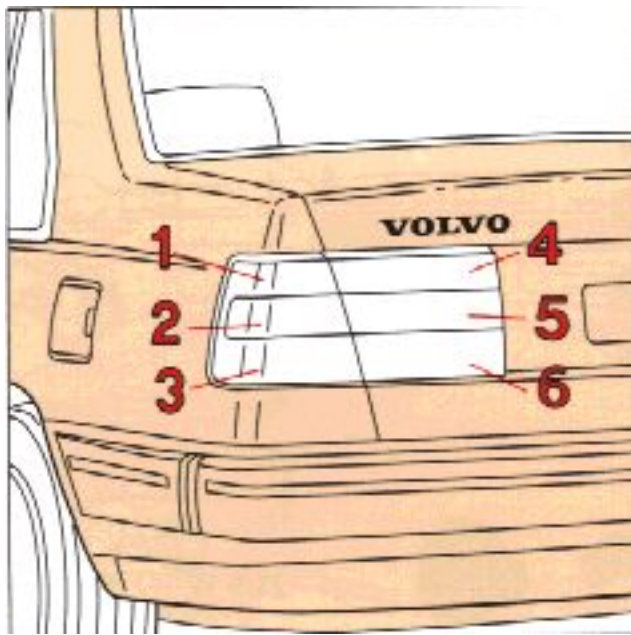

Replacing tail light bulbs (sedan models)

All tail lamp bulbs are replaced from inside of trunk. To avoid confusion, replace the bulbs one at a time.

- 1 Unscrew and remove tail lamp inside cover. Note that inside cover is hooked at the lower edge.
- 2 Remove plastic screw A and remove bulb holder and bulb (one unit).
- 3 Depress bulb in bulb holder, turn it slightly counterclockwise, and remove it.
- 4 Install a new bulb. Install bulb holder in tail lamp.
- 5 Check that bulb lights. Replace tail lamp inside cover.

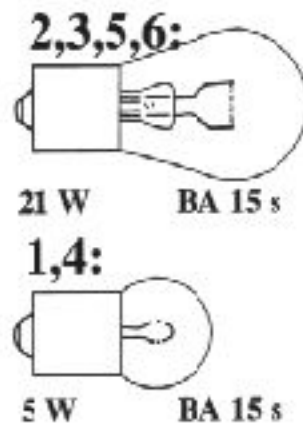

Bulbs Power Socket US Bulb No
CP(W)

- 1,4 Tail light 4 (5) BA 15s 67
- 2 Rear turn signal 32 (21) BA 15s 1156
- 3 Brake light 32 (21) BA 15s 1156

- 5 Back-up light 32 (21) BA 15s 1156
- 6 Rear foglamp* 32 (21) BA 15s 1156

* Left (driver's) side only

pg. 6:8 Replacing bulbs

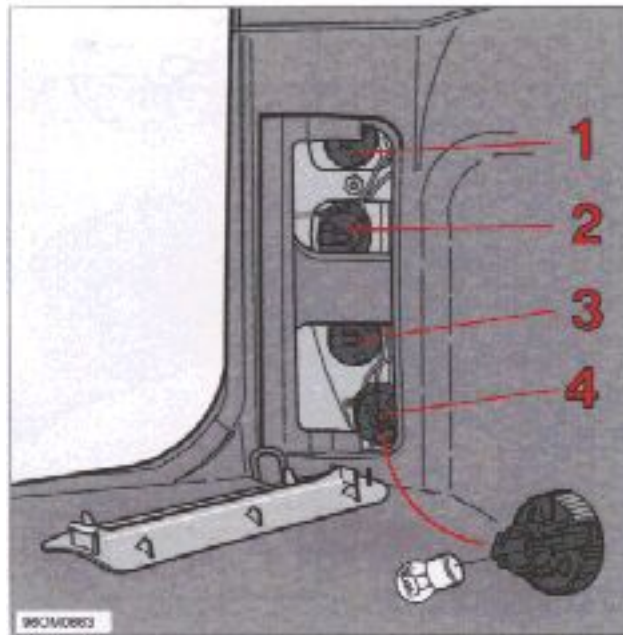

All tail light bulbs are replaced from inside the vehicle.

Replacing tail light bulbs (wagon models)

- Turn off the lights.
- Remove the cover with a screw driver.
- Rotate the bulb holder about 1/4" (0.6 cm) counterclockwise and remove the holder from the tail light cluster.
- Gently press the bulb into the holder, then rotate the bulb counterclockwise in order to release it.
- Install a new bulb in the holder and replace the bulb holder in the tail light cluster.

One of the guide lugs on the bulb holder is slightly wider than the other two and, thus, this lug fits into the widest recess only.

- Turn the bulb holder clockwise
- Check that the bulb lights
- Re-install cluster cover

Light Power CP(W) Socket US Bulb No.

- 1 Fog light* 32(21) BA15s 1156
- 2 Back-up lights 32(21) BA15s 1156

3 Turn signals 32(21) BA15s 1156

4 Brake light and tail light 32/3(21/5) BAZ 15d 1157

Reflector - - -

High-mounted stop lamp 32(21) BA15s 1156

1,2,3:

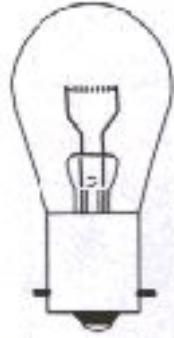

21 W
BA 15 s

4:

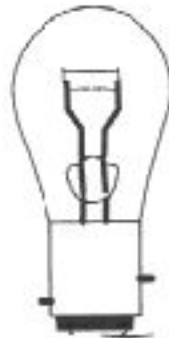

21/5 W
BAY 15 d

* Left side only

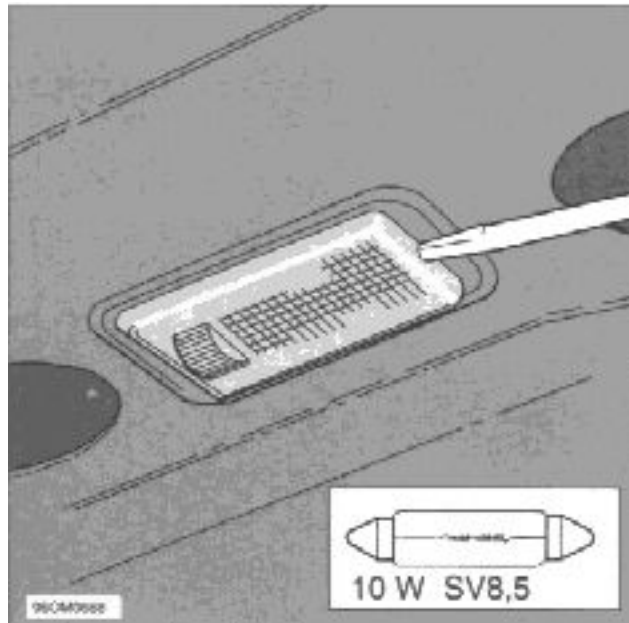

Trunk light (sedan models)
Courtesy light (wagon models)

Depress the catch with a screwdriver and remove the light assembly. Lift it out to remove. Replace the bulb.

Bulb Power Socket
Trunk light 10 W SV 8.5

WARNING! When using a screwdriver to pry plastic components, take care to avoid scratching or breakage. Use eye protection whenever possible.

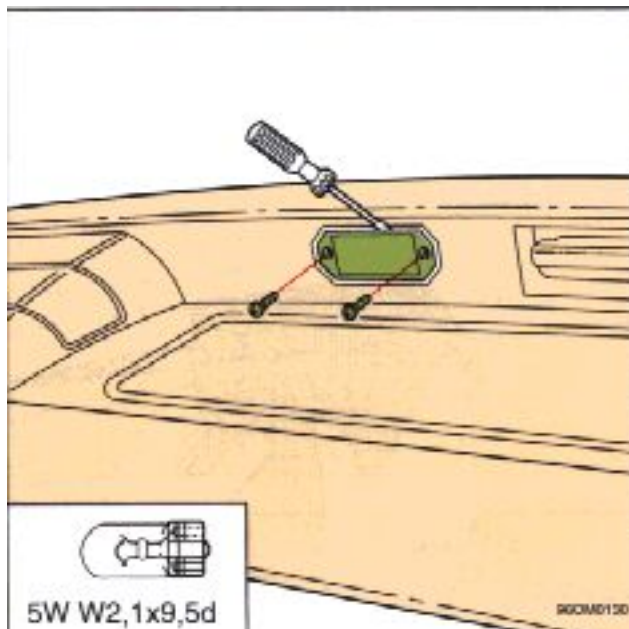

License plate light (sedan models)

Turn off the lights. Remove both screws and insert the screwdriver and turn it carefully (see illustration) until the glass comes loose. Replace the bulb and reinstall the glass.

Bulb Power Socket

License plate light 5W W 2.1x9.5d

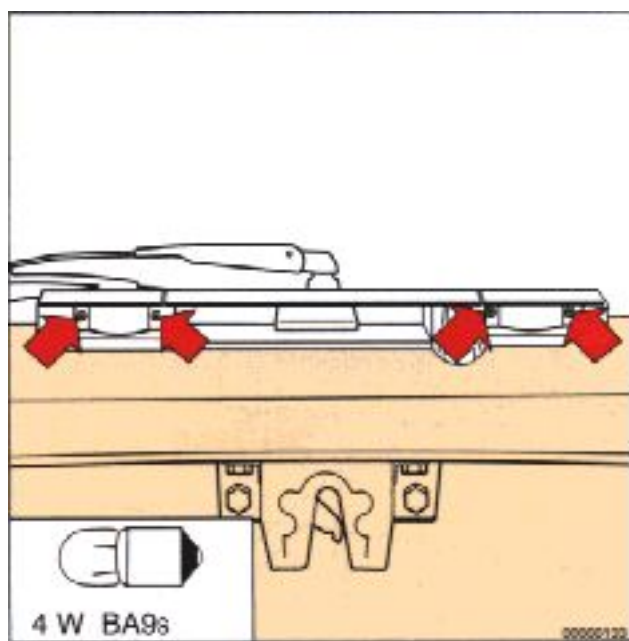

Use Phillips head screwdriver

License plate light (wagon models)

Remove the screws with a screwdriver. Remove lamp housing. Depress the bulb and rotate it counter-

clockwise. Remove the bulb. Install a new bulb and re-install lamp housing.

Bulb Power Socket

License plate light 4 W BA9s

pg. 6:10 Replacing bulbs

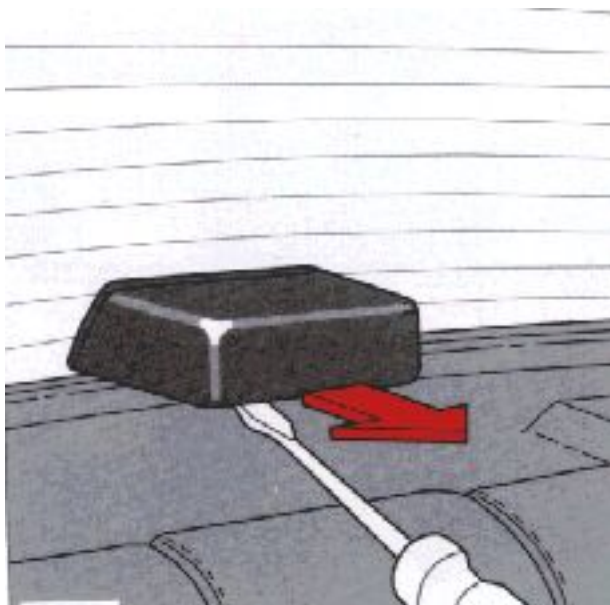

Removing cover (sedans)

High-mounted brake light

To remove: (Sedans)

Turn off ignition.

Depress catch with a screwdriver. Pull cover upward to remove it.

To remove: (Wagons)

Turn off ignition.

Grasp the cover with both hands and pull it towards you.

Bulb Power CP(W) Socket US Bulb No.

High-mounted brake light 32(21) BA15s 1156

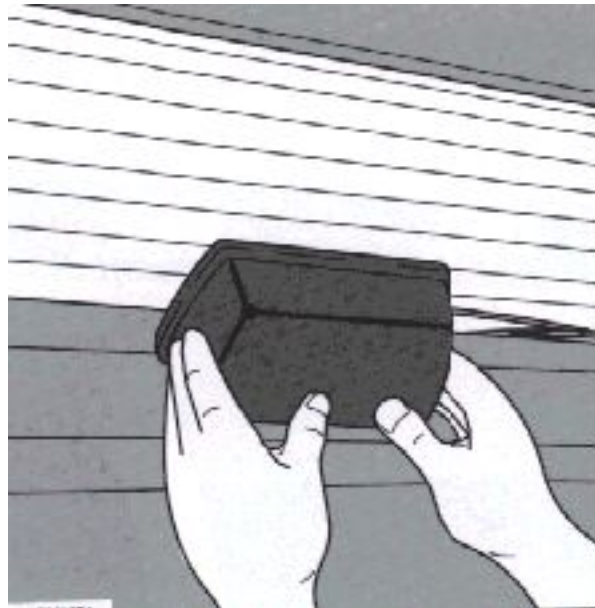

Removing cover (wagons)

Depress catches and fit new bulb.

To fit:

Fit the reflector and check that the light works.

4-door models

Press the cover into position, noting the position of the alignment pin at the top.

Wagons

Align the catches and press the cover into position.



Depress catches



Interior light and reading lights

Take hold of the front section of the light as shown and pull straight down.

Press lens out from inside and replace bulb. Check operation before reinstalling lamp housing.

NOTE:

The wiring should not be pinched when the lamp housing is reinstalled.

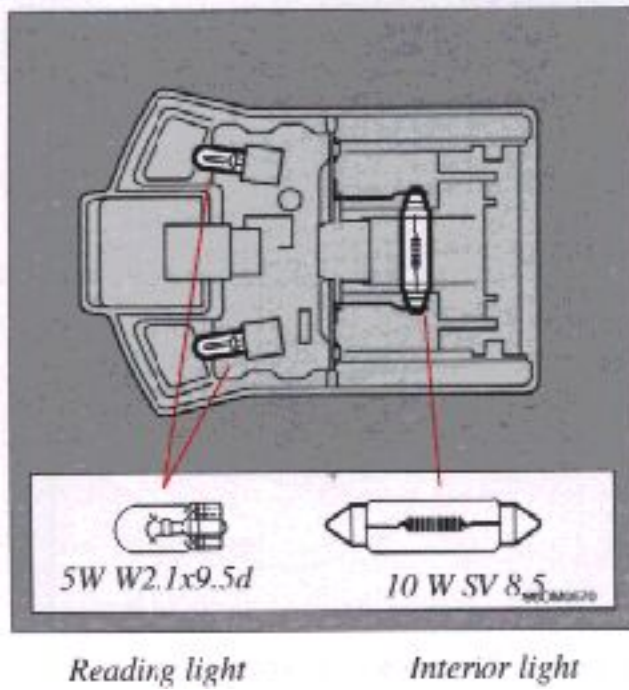

Bulb Power Socket

Interior light 10 W SV 8.5

Reading light 5 W W 2.1x9.5d

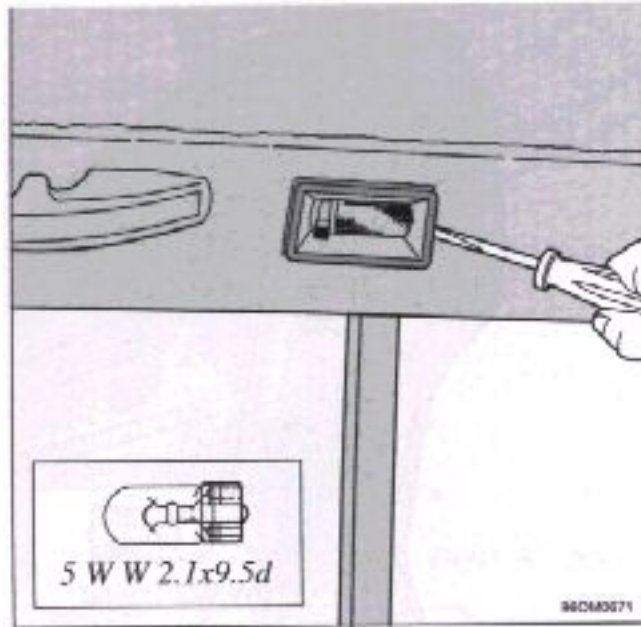

Reading lamps, rear

The bulb in the adjustable reading lamps can be changed as follows: insert a screwdriver as shown and twist off the lamp. Withdraw the bulb and fit a new one.

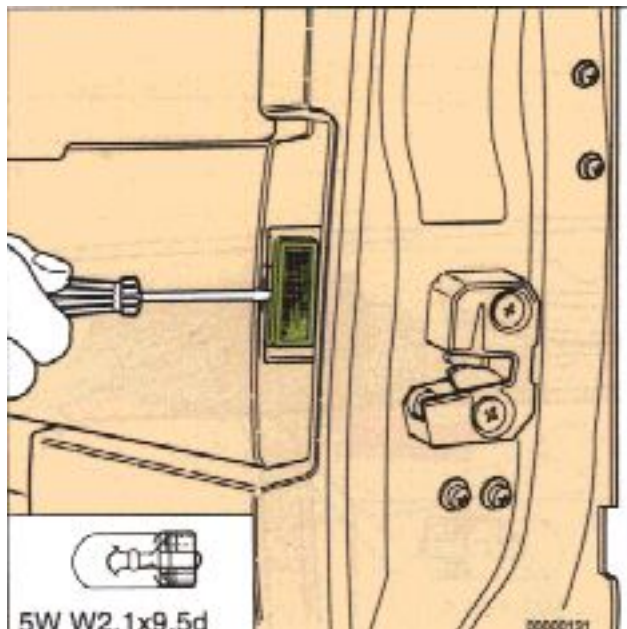

Door warning lamps

All doors are equipped with red warning lamps. To replace a bulb, insert a screwdriver as shown in picture and gently turn it to remove the lens. Withdraw the bulb, replace it and re-insert the lens.

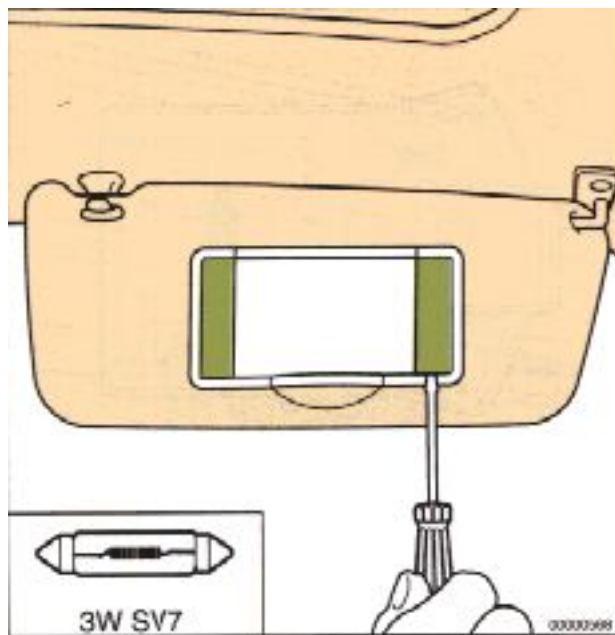

Insert screwdriver and turn
Insert screwdriver and turn

Vanity mirror

Insert a screwdriver and turn it to remove the lens. Replace the bulb and press the lens back into place.

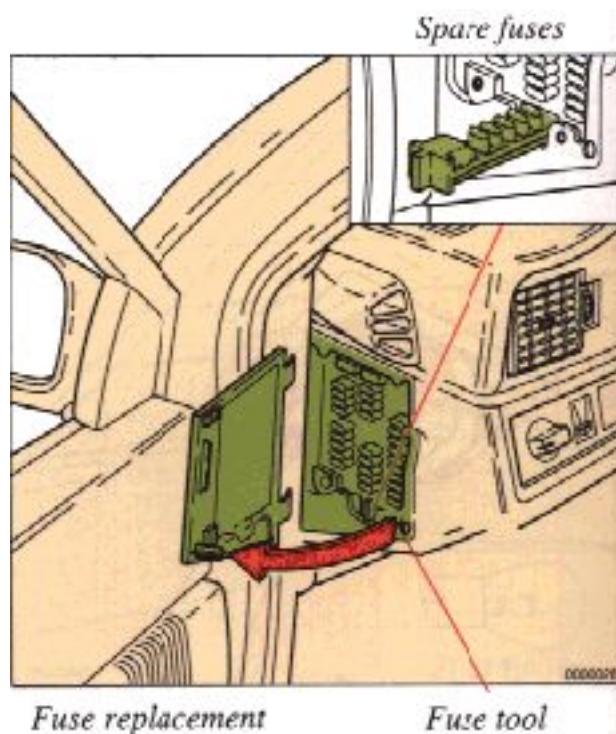

Fuse replacement

If an electrical component fails to function, it is likely that a fuse has blown due to an overloaded circuit. The fuse box is located on the far left side of the dashboard. Spare fuses and the fuse tool are located in an illuminated compartment in the fuse box. To gain access to the fuses, remove the cover. When replacing the cover, push in the front edge first and then press into place.



[Contents](#) | [Top of Page](#)

Car care

pg. 7:1 Car care

Car care includes not only maintaining the appearance of the car, but also protecting the car exterior from the effects of air pollution, rain and mud.

The rustproofing compound under the car should be checked regularly and, if necessary, damaged areas should be repaired.

The paintwork should also be touched up immediately, if damaged, to prevent rust formation.

[7:2](#) Cleaning the upholstery

[7:3](#) Rustproofing

[7:5](#) Paintwork damage

[7:7](#) Washing the car

pg. 7:2 Cleaning the upholstery

Cleaning the upholstery

The fabric can be cleaned with soapy water or a detergent. For more difficult spots caused by oil, ice cream, shoe polish, grease, etc., use a clothing/clothing fabric stain remover.

The plastic in the upholstery can be washed with soapy water or a mild detergent.

Leather upholstery can be cleaned with a soft cloth and mild soap solution.

For more difficult spots, consult your Volvo dealer.

On no account must gasoline, naphtha or similar cleaning agents be used on the plastic or the leather since these can cause damage.

Cleaning the seat belts

Clean only with lukewarm water and mild soap solution.

Cleaning floor mats

The floor mats should be vacuumed or brushed clean regularly, especially during the winter when they should be taken out for drying. Spots on textile mats can be removed with a mild detergent.

Bear in mind

- Take extra care when removing stains such as ink or lipstick since the coloring can spread.
- Use solvents sparingly. Too much solvent can damage the seat padding.
- Start from the outside of the stain and work toward the center.

pg. 7:3 Rustproofing

What causes rust

The two most common causes of rust to your car are:

- The accumulation of road dirt and moisture in hard-to-get-at cavities and other areas under the car.
- The removal of paint and protective coatings on the outside of the car and underneath through damage by stones, gravel or minor accidents.

Several factors influence the speed at which corrosion will occur:

- The length of time various parts of the car stay wet. Parts of the car filled with road dirt and water remain damp for long periods of time even after other parts have dried.

Particular attention should be paid to the underside of the car and floor sections inside. The floor sections stay wet because moisture collects and remains under the floor matting.

Drain holes located at the bottom of the doors can get clogged with dirt, trapping water inside the door and causing the door to rust through at the bottom.

- Corrosion will be accelerated in areas of higher relative humidity, especially where temperatures often stay above the freezing point and where the atmosphere is affected by industrial pollution, or where salt is used for de-icing the roads.

Where parts of the car are covered with road dirt containing road salt, corrosion will be accelerated at lower relative humidity than if the surface were clean.

- Increased temperature will cause an accelerated rate of corrosion of those parts of the car which are not well ventilated to permit quick drying.
- Industrial pollution and the presence of salt will also accelerate the deterioration of paint finishes.

The foregoing identifies the need for every car owner to keep his or her car particularly the underside as clean and dry as possible and to repair any minor damage to paintwork and protective coating as soon as possible.

The need is more important in those areas where road salt is used for de-icing, the relative humidity is higher, air pollution is present, and temperatures regularly stay above freezing.

Rustproofing, inspection and touching-up

Your Volvo was carefully and thoroughly rustproofed at the factory. The underbody and wheelhousings were sprayed with a thick, durable rustproofing compound and the beams, internal cavities and end sections were sprayed with a low viscous, penetrating rustproofing agent.

There are two very effective methods of maintaining this protection:

- Keep your car clean.

Clean the underbody, wheelhousings and the edges of the fenders using water at high pressure.

- Inspect and touch-up the rustproofing if necessary.

The invisible (internal) rustproofing

As part of your maintenance schedule, it is important that the invisible rustproofing (used for beams, internal cavities and end sections) be retreated first after 36 months and, thereafter, every 24 months. Bear in mind, if good results are to be obtained, that these sections must be treated with a fine spray of Volvo-approved rustproofing compound by your authorized Volvo dealer.

pg. 7:4 Rustproofing (cont.)

The visible rustproofing

The visible (external) rustproofing must be inspected by an authorized Volvo dealer at least once a year. If it is necessary to touch-up the rustproofing, this should be done immediately to prevent moisture penetration. Wash and dry the car thoroughly before touching up. Use spray-on or brush-on rustproofing compounds. An oil can with a long flexible spout may be used for parts which are difficult to reach.

There are three different types of rustproofing compounds available:

- a) thin (ML), for seams under the car.
- b) thin (transparent) for visible parts.
- c) thick, for parts on the underbody and wheel housing which experience most wear.

Parts of the car which may need to be touched up (and the recommended rustproofing compound) are:

- visible welded seams and panel seams-(thin)
- underbody and wheel housing-(thick)
- door hinges-(thin)
- hood hinges and locks-(thin)

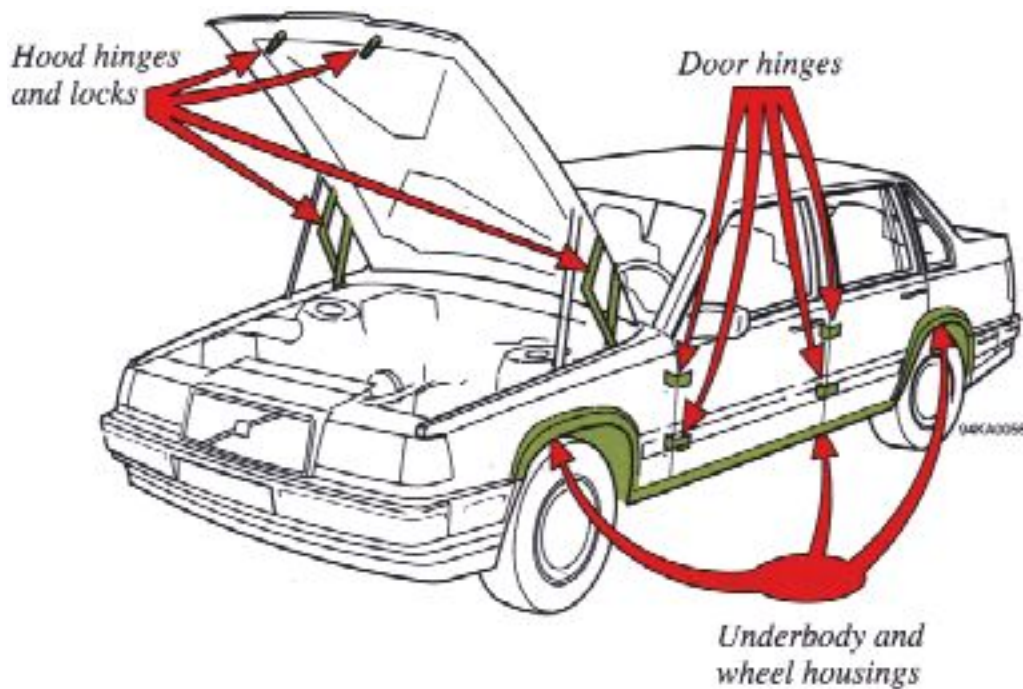

After completion of all work on the vehicle, remove excess rustproofing compound with a cloth soaked in kerosene.

The sheet metal surfaces of the engine compartment are protected by a transparent wax-based rustproofing compound. The compound withstands normal washings without deterioration.

Mineral based solvents will, however, dissolve the compound, especially so if they contain emulsifiers. In such cases the wax protection should be renewed.

pg. 7:5 Paint touch-up

Paint touch-up

Paint damage requires immediate attention to avoid rusting. Make it a habit to check the finish regularly; when washing the car for instance. Touch up if necessary.

Paint repairs require special equipment and skill. Contact your Volvo dealer for any extensive damages.

Minor scratches can be repaired by using Volvo touch-up paint.

NOTE: When ordering touch-up paint from your Volvo dealer, use the paint code indicated on the model plate. The plate is located on the panel above the right-side head lights.

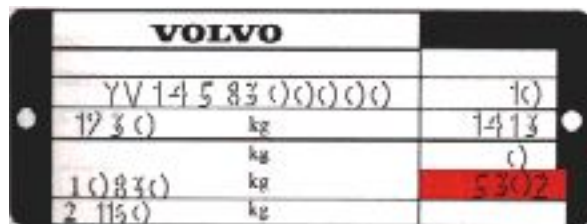

Minor stone chips and scratches

Material:

Primer - can

Paint - spray can or touch-up bottle

Brush

Masking tape

Note: When touching up the car, it should be clean and dry. The surface temperature should be above 60°F (+15°C).

Scars on the surface

If the stone chip has not penetrated down to the metal and undamaged layer of paint remains, the touch-up paint can be applied as soon as the spot has been cleaned.

Deep scars

If the stone chip has penetrated down to the metal, proceed as follows:

1 Place a strip of masking tape over the damaged surface. Pull the tape off so that any loose flakes of paint adhere to it.

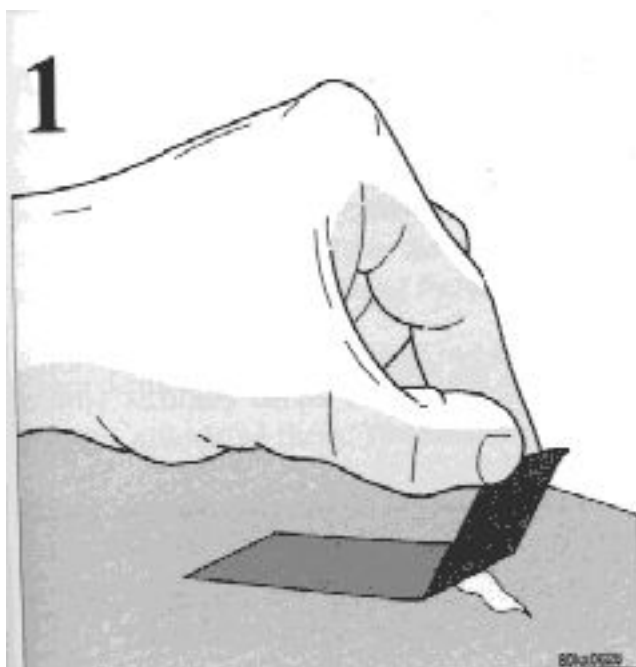

2 Thoroughly mix the primer and apply it with a small brush.

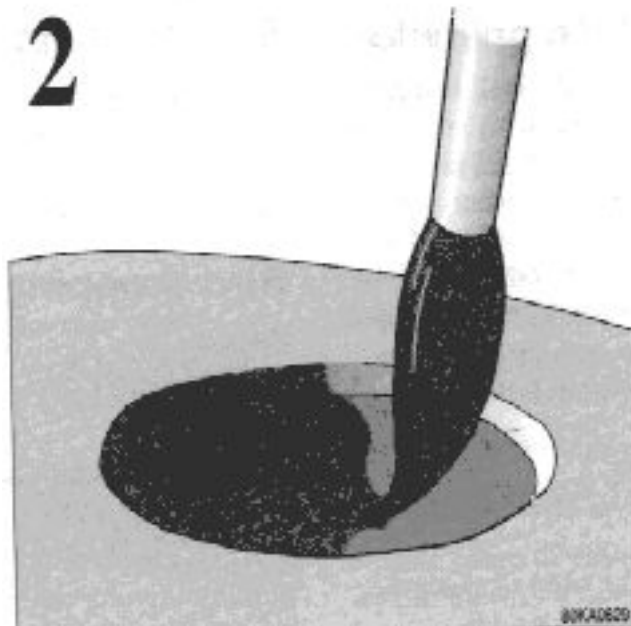

When the primer surface is dry, the paint can be applied using a brush.
Mix the paint thoroughly: apply several thin paint coats and let dry after each application.

pg. 7:6 Paint touch-up (cont.)

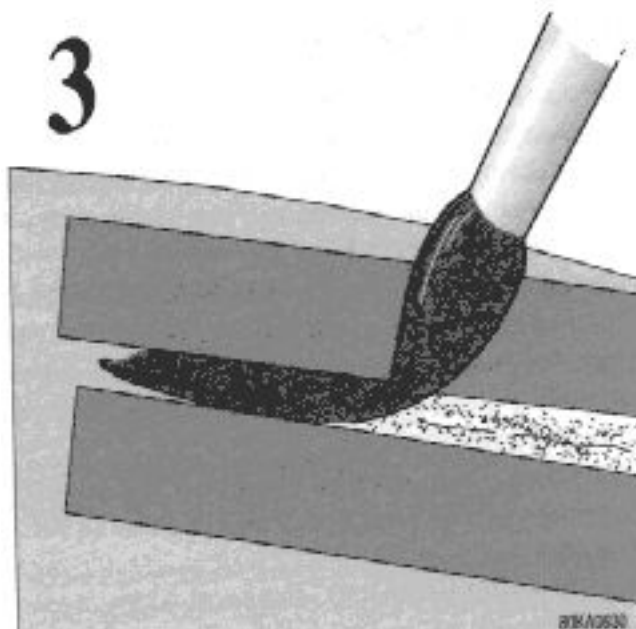

3 If there is a longer scratch, you may want to protect surrounding paint by masking it off.

Touching up damaged paint on fender edges and sills

Material:

Primer - spray can
Paint-spray can
Masking tape

Note: When touching up the car, it should be well cleaned and dry and have a temperature exceeding 60° F (+15°C).

When large surfaces have to be repainted, suitably mask the surrounding area with masking tape and paper.

Remove this masking as soon as the final coat has been sprayed on, before the paint dries.

1 Remove loose flakes of paint with masking tape.

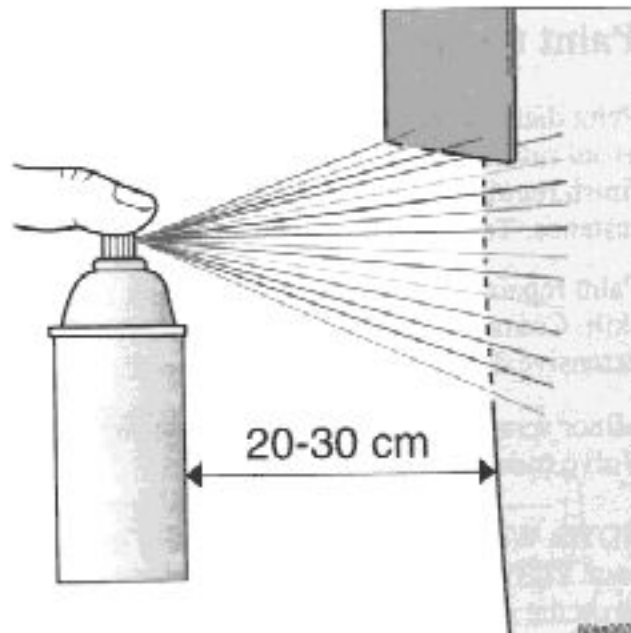

2 Move the spray can slowly and regularly from side to side, about 8-12 inches (20-30 cm) from the surface.

WARNING!

Spray painting should be done in a well-ventilated and dust-free area.

3 When the primer has dried apply the surface enamel in the same way. Spray on several times and allow the paint to dry a minute or so between each application.

pg. 7:7 Washing

Washing the car

The car should be washed at regular intervals since dirt, dust, insects and tar spots adhere to the paint and may cause damage.

When washing the car, do not expose it to direct sunlight. Use lukewarm water to soften the dirt before you wash with a sponge, and plenty of water, to avoid scratching.

A detergent can be used to facilitate the softening of dirt and oil. A water-soluble grease solvent may be used in cases of sticky dirt. However, use a washplace equipped with a drainage separator. Dry the car with a clean chamois and remember to clean the drain holes in the doors and rocker panels.

The power radio antenna must be dried after washing.

Tar spots can be removed with kerosene or tar remover after the car has been washed.

A stiff-bristle brush and lukewarm soapy water can be used to clean the wiper blades. Frequent cleaning improves visibility considerably.

Note: It is particularly important to wash the car frequently in the wintertime to prevent corrosion, when salt has been used on the roads.

Also wash off the dirt from the underside (wheel housings fenders, etc..) In areas of high industrial fallout more frequent washing is also recommended.

Note:
During high pressure washing the spray mouth piece must never be closer to the vehicle than 13" (30 cm). Do not spray into the locks.

Suitable detergents

Special car washing detergents or liquid dishwashing detergent can be used. A suitable mixture is about 2.5 fl. oz. (8.5 cl.) of detergent to 2.6 US gal. (10 liters) of warm water. After washing with a detergent the car should be well rinsed with clean water.

Bird droppings

Remove from paintwork as soon as possible. Otherwise the finish may be permanently damaged.

WARNING!

When the car is driven immediately after being washed, apply the brake several times in order to remove any moisture from the brake linings.

Engine cleaning agents should not be used when the engine is warm. This constitutes a fire risk.

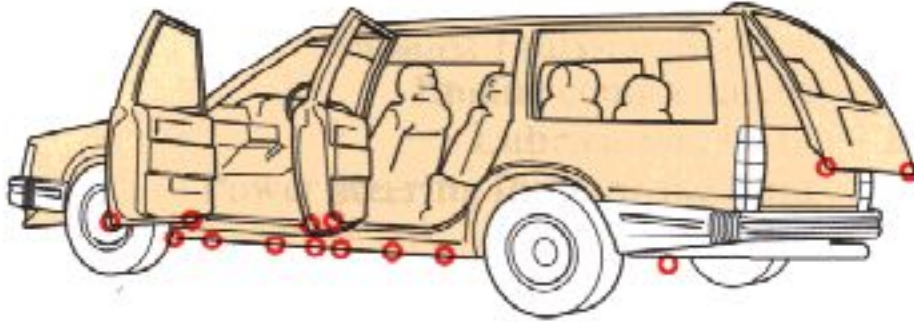

NOTE: When washing the car, remember to remove dirt from the drain holes in the doors and sills.

pg. 7:8 Automatic car washing, Polishing and waxing, Chromed parts

Automatic washing - simple and quick

An automatic wash is a simple and quick way to clean your car, but it is worth remembering that it may not be as thorough as when you go over the with sponge and water. Keeping the underbody clean is most important, especially in the winter. Some automatic washers do not have the facilities for washing the underbody.

Before driving into an automatic wash, make sure that the side view mirrors, auxiliary lamps, etc., are secure, otherwise there is risk of the machine dislodging them. You should also lower the antenna.

We recommend that you do not wash your car in an automatic wash during the first six months (because the paint will not have hardened sufficiently).

Polishing and waxing

Normally, polishing is not required during the first year after delivery, however, waxing may be beneficial.

Before applying polish or wax the car must be washed and dried. Tar spots can be removed with kerosene or tar remover. Difficult spots may require a fine rubbing compound.

After polishing use liquid or paste wax.

Several commercially-available products contain both polish and wax. Waxing alone does not substitute for polishing of a dull surface.

A wide range of polymer-based car waxes can be purchased today. The waxes are easy to use and produce a long-lasting, high-gloss finish that protects the bodywork against oxidation, road dirt and fading.

Chromed parts

Chromium-plated and anodized parts should be washed with clean water as soon as they become dirty. This is particularly important if you drive on gravel roads or on roads where salt is used during the winter. After the car has been washed, apply wax or an anti-rust preparation.

Stains on chrome trim can be removed with commercially-available chrome cleaner. Do not use abrasive compounds or steel wool.



[Contents](#) | [Top of Page](#)

Service - an investment!

An investment which will pay dividends in the form of improved reliability, durability, and resale value.

[8:2](#) Label Information

[8:3](#) Maintenance service, Warranty

[8:4](#) Maintenance schedule

[8:6](#) Engine oil

[8:8](#) Exhaust Emission Service

[8:13](#) Engine compartment

[8:14](#) Rear axle oil

[8:14](#) Lubrication, body

[8:15](#) Power steering fluid, brake fluid

[8:16](#) Drive belts

[8:17](#) Coolant

1 Vehicle Identification Number (VIN) *

VIN plate is located on top left surface of dashboard. The VIN is also stamped on the right hand door pillar.

2 Vehicle Emission Control Information

Your Volvo is designed to meet all applicable emissions standards, as evidenced by the certification label on the right side of the firewall. For further information regarding these regulations, please consult your Volvo dealer.

3 Model Plate

Vehicle Identification Number (VIN). Codes for color and upholstery etc.. This plate is located on panel-above right headlight.

4 Loads and Tire Pressures

5 Federal Motor Vehicle Safety Standards (FMVSS) specifications (USA) and Ministry of Transport (CMVSS) Standards (Canada)

Your Volvo is designed to meet all applicable safety standards, as evidenced by the certification label on the rear facing side of the driver's door. For further information regarding these regulations, please consult your Volvo dealer.

* The Vehicle Identification Number (VIN) should always be quoted in all correspondence concerning your vehicle with the retailer and when ordering parts.

All specifications are subject to change without notice.

pg. 8:3 Maintenance service, Warranty

Maintenance service at 10,000 mile (16,000 km) intervals

Volvo advises you to follow the service program at 10,000 mile (16,000 km) intervals which is outlined in the "Maintenance Records Manual". This maintenance program contains inspections and services necessary for the proper function of your car over the next 10,000 miles (16,000 km).

The maintenance services contain several checks which require special instruments and tools and therefore must be performed by a qualified technician.

To keep your Volvo in top condition, specify time tested and proven Genuine Volvo Parts and Accessories.

The Federal Clean Air Act - U.S.

The Clean Air Act requires vehicle manufacturers to furnish written instructions to the ultimate purchaser to assure the proper functioning of those components that control emissions.

The maintenance instructions listed in the "Servicing" section of this Manual represent the minimum maintenance required. These services are not covered by the warranty. You will be required to pay for labor and material used. Refer to your Warranty booklet for further details.

Maintenance services

Your Volvo has passed several major inspections before being delivered to you, according to Volvo specifications. The maintenance services outlined in this book should be performed as indicated. The extended maintenance service intervals make it even more advisable to follow this program. Inspection and service should also be performed any time a malfunction is observed or suspected. It is recommended that receipts for vehicle emission services be retained in the event that questions arise concerning maintenance. See your "Maintenance Records Manual".

Applicable warranties - U.S.

In accordance with U.S. Federal Regulations, the following list of applicable U.S. warranties is provided. For Canadian specification vehicles, see your separate warranty booklet.

- New Car Limited Warranty
- Parts and Accessories Limited Warranty
- Corrosion Protection Limited Warranty
- Seatbelt and Supplemental Restraint Systems Limited Warranty
- Emission Design and Defect Warranty
- Emission Performance Warranty

These are the Federal warranties; other warranties are provided as required by state law.

Refer to your separate Warranty booklet for detailed information concerning each of the warranties.

pg. 8:4 Maintenance schedule

Maintenance schedule

A = Adjust (Correct if necessary) I = Inspect (Correct or Replace if necessary)

R = Replace L = Lubricate

Maintenance Operation

thousand miles	5	10	20	30	40	50	60
(thousand km)	(8)	(16)	(32)	(48)	(64)	(80)	(96)

EMISSIONS SYSTEM

MAINTENANCE

Engine Oil and Oil filter	R	R	R	R	R	R	R
---------------------------	---	---	---	---	---	---	---

Engine Drive Belts							R
--------------------	--	--	--	--	--	--	---

Air Cleaner Filter			R			R
Spark Plugs			R			R
Automatic Transmission fluid	I	I	I	I	I	I
Rear Axle Oil	I	I	I	I	I	I
Timing belt - B 6304 F			R			R

- 1) See section "Engine oil" for detailed information.
- 2) For services beyond 60,000 miles (96,000 km), consult your "Maintenance records manual" and "Maintenance Service Chart."
- 3) No cost to the owner.
- 4) Recommended, not required - no cost to the owner.
- 5) Every 30,000 miles (48,000 km): lubricate belt tensioner pulley

pg. 8:5 Maintenance schedule

Maintenance Operation thousand miles (thousand km)	10 (16)	20 (32)	30 (48)	40 (64)	50 (80)	60 (96)
MISCELLANEOUS MAINTENANCE						
ENGINE						
Fuel (Line) Filter						
PCV Nipple (Orifice)/hoses,clean						I
Battery Charge		I		I		I
EGR valve, clean						I
BRAKES						
Inspect Brakes, Replace components as necessary	I	I	I	I	I	I
Brake Fluid			R			R
STEERING						
Tire wear; (Align if needed.)	I	I	I	I	I	I
Check power steering fluid level.	I	I	I	I	I	I
BODY						
Power antenna (clean)	I	I	I	I	I	I

Trunk, Hood Hinges and Latches

L

L

L

L

L

L

The following items should be checked weekly by the driver (it takes only a few minutes):

Engine oil level Windshield wipers Cleaning

Brake fluid level Level of windshield washer fluid Rust protection

Radiator coolant level The following should also be carried out at

Tire pressure (all five tires) regular intervals:

Operation of all lights Washing

Horns Polishing



[Contents](#) | [Top of Page](#)

pg. 8:13 Engine compartment

Engine compartment 960 (engine B 6304 S)

- 1 Expansion tank, coolant
- 2 Oil filler cap, engine
- 3 Engine oil dip-stick
- 4 Brake fluid reservoir
- 5 Data Plate
- 6 Battery
- 7 Radiator
- 8 Power steering fluid reservoir
- 9 Air cleaner
- 10 Washer fluid reservoir

WARNING!

The cooling fan may start or continue to operate (for up to 6 minutes) after the engine has been switched off.

pg. 8:14 Lubrication

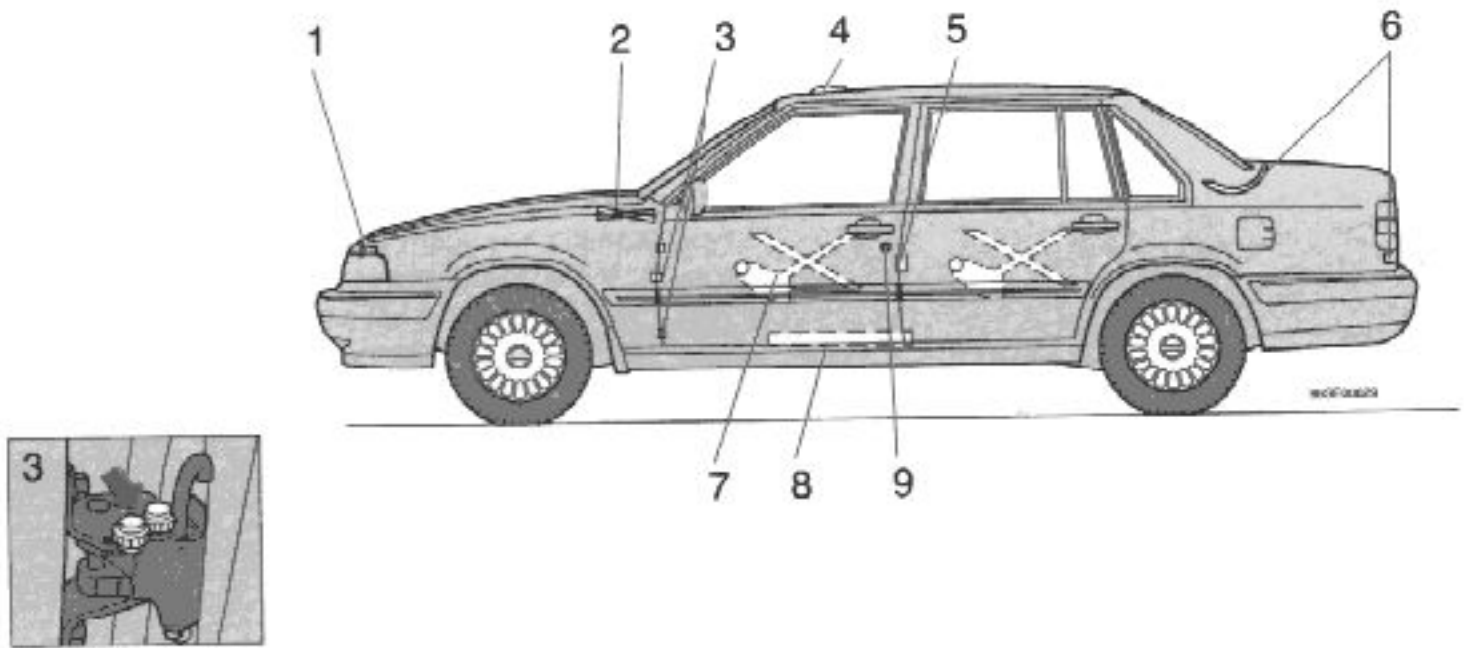

Door stop

No. Lubricating hint Lubricant

- 1 Hood lock and latch Oil
- 2 Hood hinges Oil
- 3 Door stop and hinges Oil
- 4 Sun roof wind deflector Oil
- Sun roof mechanism Grease
- 5 Door lock catch plate Oil
- 6 Trunk lid lock Low temperature keyhole and hinges grease
- 7 Window regulator Oil, grease locking device low temperature (on inside of door) grease
- 8 Front seat slide rail and latch Oil
- 9 Door lock keyhole Low temperature grease or Volvo Teflon lock spray

To avoid rattles and unnecessary wear, the body should be lubricated at regular service intervals. This should be done by an authorized Volvo retailer.

pg. 8:15 Brake fluid, Power steering fluid

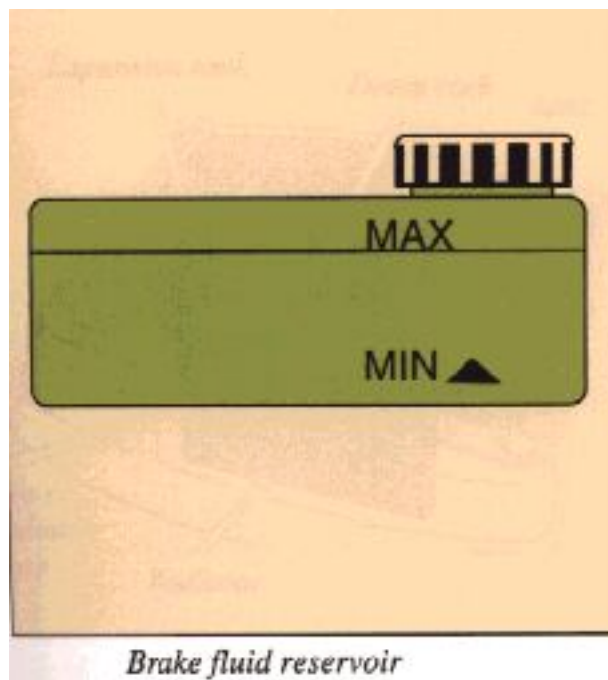

Brake fluid

The fluid level should be between the MIN and MAX marks.

Fluid type: DOT 4+

Replace: every second year or 30,000 miles (48,000 km). The brake fluid should be replaced once a year or every 15,000 miles (25,000 km) when driving under extremely severe conditions (mountain driving, hot climate, high humidity etc..)

Check, without removing the cap, that the level is above the "MIN" mark of the fluid reservoir. Always entrust brake fluid changing to an authorized Volvo retailer.

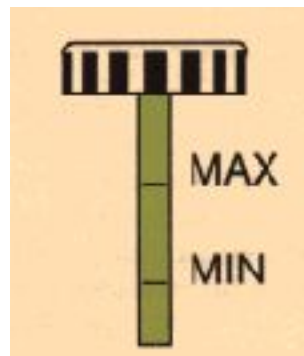

Power steering fluid

The fluid level should lie between the MIN and MAX on the side of the dipstick. The space between the marks corresponds to 0.2 US qts/liters.

Fluid type: ATF

Replace: no fluid change required.

pg. 8:16 Drive belt

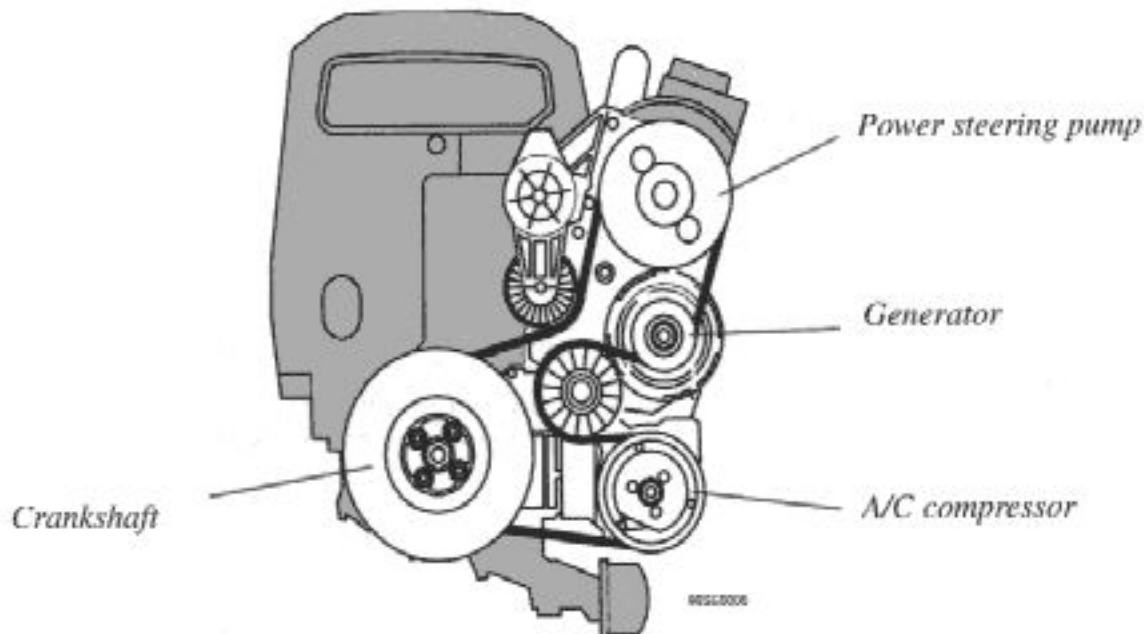

Belt check

Check the belt regularly to make sure it is in good condition and is clean. A worn or dirty belt can cause poor cooling and low generator output as well as impair the operation of the power steering and the air conditioning unit.

WARNING! The engine must not be running when this check is performed.

NOTE : The belt on the 960 is equipped with a self-tensioning mechanism and requires no adjustment between changes.

pg. 8:17 Cooling system

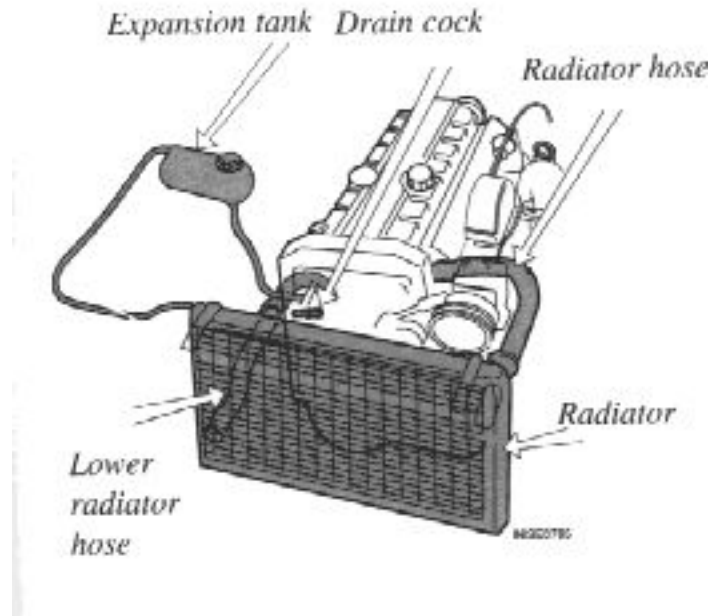

Check coolant level

The cooling system must be filled with coolant and not leak to operate at maximum efficiency. Check the coolant level regularly. The level should be between the "Max" and "Min" marks on the expansion tank. The check should be made with particular thoroughness when the engine is new or when the cooling system has been drained.

Do not remove the filler cap other than for topping-up with coolant. Frequent removal may prevent coolant circulations between the engine tank during engine warm-up and cooling.

Changing coolant

Normally, the coolant does not need to be changed. If the system must be drained, use the following procedure:

Remove the expansion tank cap. Open the drain cock on the right side of the engine block and disconnect the lower radiator hose.

Fill coolant through the expansion tank. The heater controls should be fully open when draining and filling.

Add coolant until the level is up to the MAX mark or slightly above.

Start the engine and run until hot. Check the cooling system connections for tightness. Also re-check the coolant level.

Capacity: See "Specifications"

CoolAnt: Volvo Genuine Coolant/Antifreeze only

CAUTION

The cooling system must always be kept filled to correct level.
If it is not kept filled, there can be high local temperatures in the engine which could result in damage.
Different types of anti-freeze/coolant may not be mixed.

WARNING! If the engine is warm and you are going to top up coolant, unscrew the cap slowly in order to allow any excess pressure to escape.

NOTE: Do not top up with water only. Water by itself reduces the rust-protective and anti-freeze qualities of the coolant and has a lower boiling point. It can also cause damage to the cooling system if it should freeze.



[Contents](#) | [Top of Page](#)

pg. 8:6 Engine oil

Checking the oil level

The oil level should be checked every time the car is refuelled.
This is especially important during the engine break-in period (up to the first service).

CAUTION : Not checking the oil level regularly can result in serious engine damage if the oil becomes too low.

Be sure the oil level is maintained between the upper and lower marks on the dip-stick. Low oil level can cause internal damage to the engine and over-filling can result in high oil consumption. The distance between the dipstick marks represents approx. 1 US qt (1 liter) of oil. Before checking the oil level after the car has been driven, park the car on a level surface and wait at least 5 minutes after the engine has been switched off. The oil level should be half-way between the MIN and MAX marks. If the oil is checked before the car is driven (engine completely cold) the oil level should be at the MAX mark.

NOTE: The engine must be stopped when checking the oil.

Draining the oil

Drain the oil after driving while it is still warm.

WARNING! The oil may be very hot.

If you change the engine oil and filter yourself, your Volvo retailer can assist you in disposing of the used oil. Engine oil can be harmful to your skin - gloves should worn when performing this work.

To add or change engine oil

Add oil of the same kind as already used.
Capacity (including filter): 5.9 US qts = 5.75 liters.

Changing oil filter

Replace the oil filter at every oil change

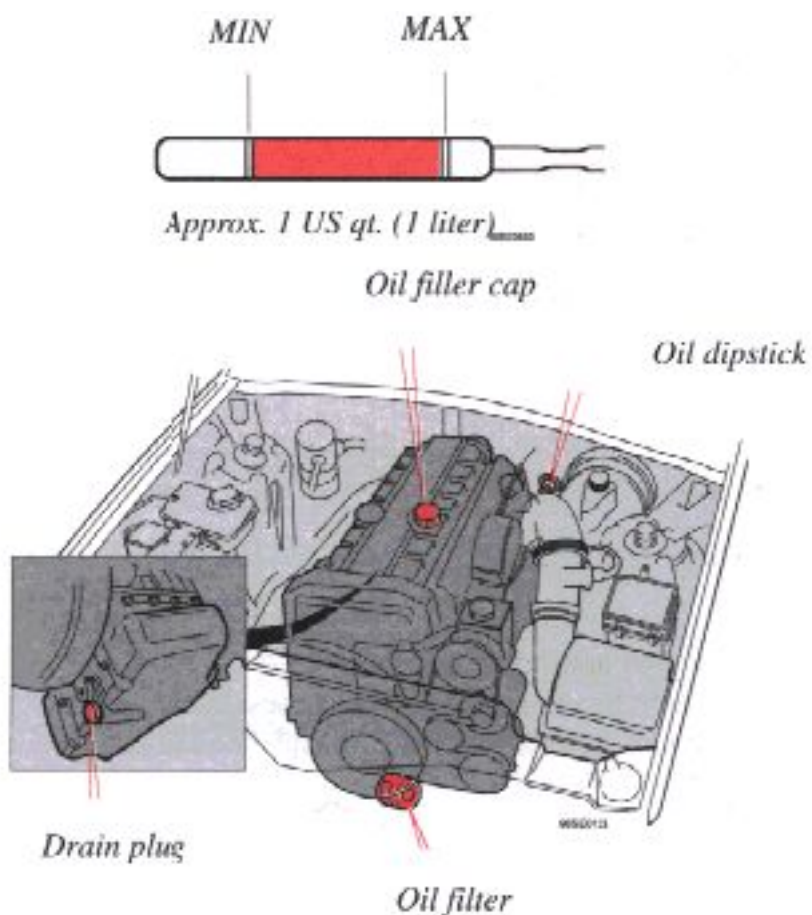

WARNING! Oil spilled on a hot exhaust pipe constitutes a fire risk.

pg. 8:7 Engine Oil, 10,000-mile (16,000-km) oil/oil filter change interval

Oil quality

Meeting API specification SG

For best fuel economy and engine protection consult with your authorized Volvo retailer for recommended oils. Oils with a different quality rating may not provide adequate engine protection.

Viscosity (stable ambient temperatures):

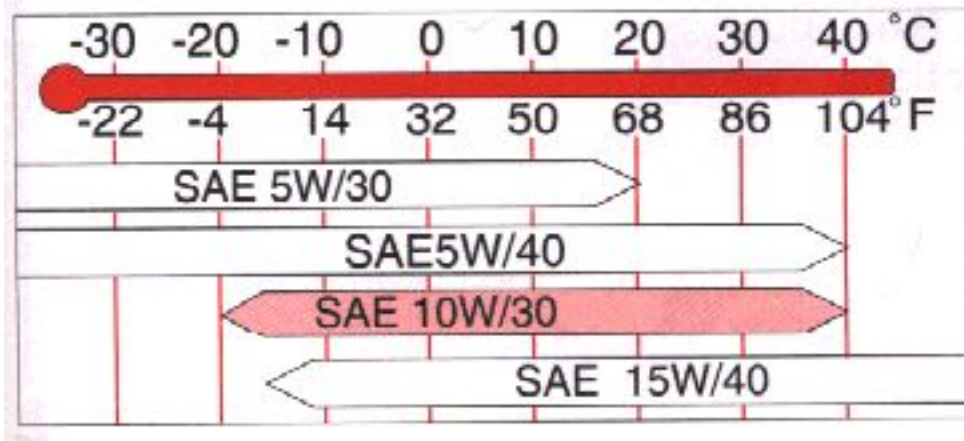

Do not use oils with other viscosity ratings. The use of incorrect viscosity oil can shorten engine life. Volvo recommends the use of energy-conserving oils. Look for the API label. Synthetic oils complying with oil quality requirements are recommended for: driving in areas of sustained temperature extremes (hot or cold), when towing a trailer over long distances or for a prolonged driving in mountainous areas. Extra oil additives must not be used unless advised by an authorized Volvo retailer. SAE 15W/40 is recommended for use in driving conditions that raise oil temperature and increase oil consumption (i.e., mountain driving; trailer towing).

NOTE: SAE 15W/40 must not be used at low ambient temperatures; see viscosity chart.

Changing oil and oil filter

Oil and oil filter are first changed at 5,000 miles (8,000 km). This service is provided by Volvo to the owner at no cost. The next oil and filter change occurs at the 10,000 mile (16,000 km) service and thereafter at 10,000 mile (16,000 km) intervals or as specified in the following table:

If driving conditions include:	Then the correct oil/oil filter change interval is:
<ul style="list-style-type: none"> ● Extended periods of idling and/or low-speeds operation ● Frequent short trips (less than 7 miles = 11 km) ● Extended periods of driving in dusty and/or sandy areas ● Trailer towing ● Driving in mountainous areas 	<p>EVERY 6 MONTHS OR EVERY 5,000 miles = 8,000 km WHICHEVER COMES FIRST</p>
<ul style="list-style-type: none"> ● Primarily highway driving ● Frequent trips of longer than 7 miles = 11 km ● Normal driving 	<p>EVERY 12 MONTHS OR EVERY 10,000 miles = 16,000 km WHICH EVER COMES FIRST</p>



Volvo recommends the use of oils with the American Petroleum Institute (API) label, This label certifies that the oil conforms to the applicable standards and specifications of the API.

pg. 8:8 Servicing

Torque exhaust and intake manifold nuts

A loose manifold could alter air/fuel ratio and cause an increase in emissions and/or poor driveability.

Air cleaner

Replace the air cleaner cartridge with a new one every 30,000 miles (48,000 km). The cartridge should be replaced more often when driving under dirty and dusty conditions, The filter cannot be cleaned and, therefore, should always be replaced with a new one.

Vacuum fittings, hoses and connections

Unstable idle, misfiring, or poor emission control is often caused by leaking vacuum hoses or connections. Check hoses and connections on distributor vacuum unit, connections on heater control servo systems and hydraulic brake servo.

Checking and adjusting idle air control system

Your Volvo is equipped with an electronically-controlled idle air control system that requires no checking or adjustment.

Fuel system cap, tank and lines, and connections

The effectiveness of the fuel system to contain hydrocarbons is dependent largely on a leakfree system. Check for proper sealing of gasoline filler cap which contains "O" ring-type seals. Check all evaporative

hoses in vehicle for tightness. Check fuel lines under vehicle and repair if necessary.

Fuel (line) filter

The fuel line filter is located next to the fuel pump. This filter is to be changed every 60,000 miles (96,000 km). The filter is replaced as one complete unit.

Replace more frequently if contaminated fuel is introduced into the tank (or if there is reason to suspect that this has occurred).

Timing gear belt

Volvo recommends that the this belt be replaced at 30,000 mile (48,000 km) intervals. The first replacement at 30,000 miles (48,000 km) is provided by Volvo at no cost to the owner. All subsequent replacements are the responsibility of the car owner.

Exhaust Gas Recirculation (EGR)

This system operates by returning some of the exhaust gases to the engine to be recombusted: since this lowers the combustion temperature the amount of nitrogen oxides released into the atmosphere is reduced.

The EGR valve should be inspected at 60,000 miles (96,000 km) and thereafter cleaned every 20,000 miles (32,000 km).

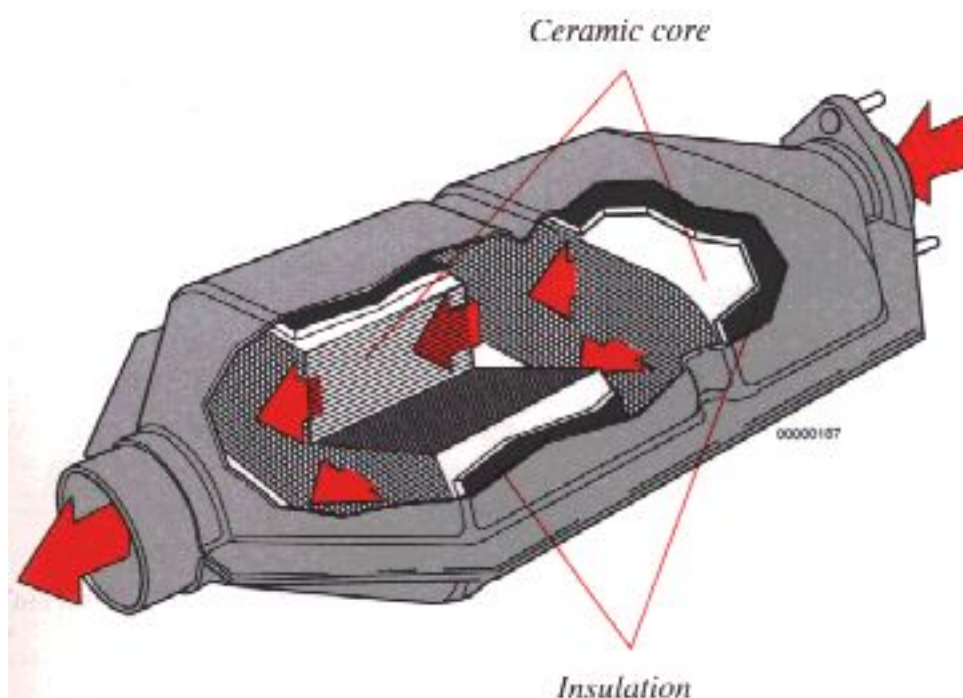

Three-way Catalytic Converter

This is a supplementary device in the exhaust system, designed to clean exhaust gases. This device is mainly a container with a ceramic material insert, designed to let the exhaust gases pass through channels in the insert. The channel walls are covered by a thin layer of platinum-palladium. These metals act as catalysts, permitting a chemical action to occur without actually taking part in it. The emission (CO, HC, NO_x) content will increase if the three-way catalytic converter is damaged. Vehicles equipped with heated oxygen sensors use three-way catalytic converters containing platinum and rhodium.

CAUTION:

Vehicles with a three-way catalytic converter must use unleaded fuel only. Otherwise the three-way catalytic converter will become ineffective. See "Fuel requirements".

pg. 8:10 Servicing

Multiport Fuel Injection System (MFI)

MFI is all-electronic and microprocessor-controlled. It can continually compensate for variations in engine load, speed and temperature to give the best economy and power. An important feature of the system is a mass air flow sensor that measures the mass of the inducted air instead of the volume. In this way the system can make instantaneous adjustments for changes in air temperature or density, thus always assuring the best economy with the lowest possible exhaust emissions.

Heated oxygen sensor

This is an emission control system designed to reduce emissions and improve fuel economy. The heated oxygen sensors monitor the composition of the exhaust gases leaving the engine. The exhaust gas analysis is fed into an electronic module. This adjusts the air-fuel ratio to provide optimum conditions for combustion and efficient reduction of the three major pollutants (hydrocarbons, carbon monoxide and oxides of nitrogen) by a three-way catalytic converter.

Pulsed Secondary Air Injection (certain models)

This system adds air to the hot exhaust gases as they are expelled from the engine. This causes a secondary combustion of residual hydrocarbons and carbon monoxide, resulting in lower emissions levels in the exhaust gases.

pg. 8:11 Servicing

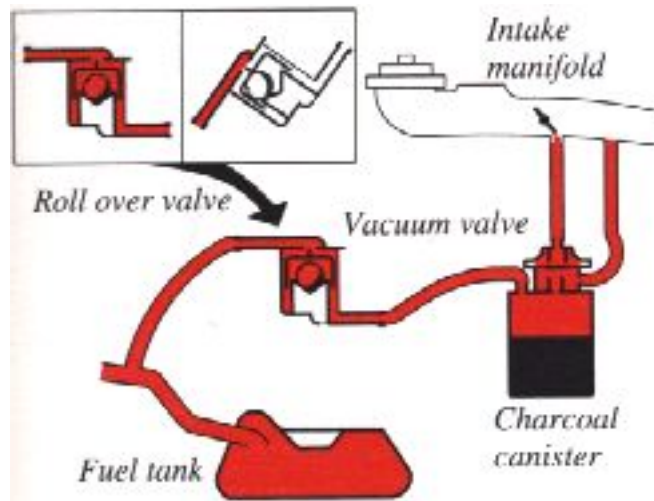

Evaporative control system

The car is equipped with a gas evaporative control system, which prevents gasoline fumes from being released into the atmosphere. The system is comprised of an expansion chamber in the fuel tank, a roll-over valve on the cross member in front of the fuel tank, and a charcoal canister with built-in vacuum valve under the left-front wheel housing. The components are interconnected by hoses which channel fuel vapor from the gas tank to the charcoal filter, where it is stored until the engine is started and then drawn into the engine's fuel induction system.

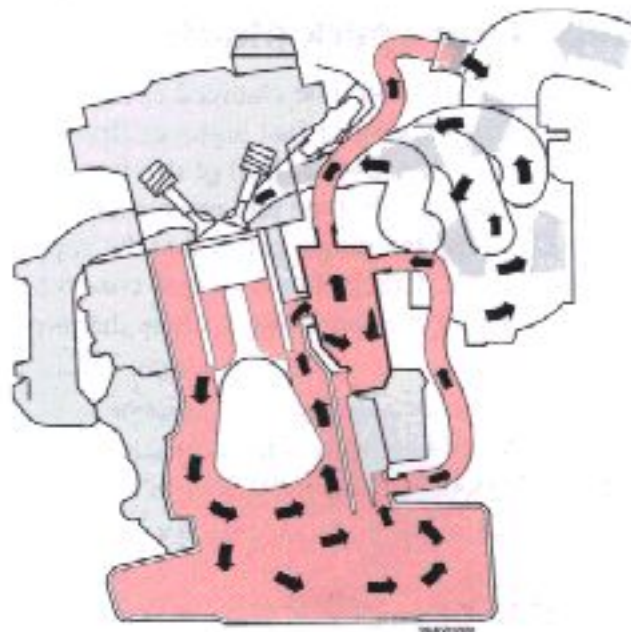

Crankcase ventilation

The engine is provided with positive crankcase ventilation which prevents crankcase gases from being released into the atmosphere. Instead, the crankcase gases are admitted to the intake manifold and cylinders.

PCV system

The orifice nipple in the intake manifold and the filter at the end of the PCV hose in the aircleaner should be inspected every 60,000 miles (96,000 km). Check/replace rubber hoses at the same time.

pg. 8:12 Servicing

Replacing spark plugs

The spark plugs should be changed every 30,000 miles (48,000 km). However, city driving or fast highway driving may necessitate changing after 15,000 miles (24,000 km) of driving. When installing new plugs, be sure to fit the right type and use correct torque, see Specifications. When changing the plugs, check that the suppressor connectors are in good condition. Cracked or damaged connectors should be replaced. When changing the spark plugs, clean the terminals and the rubber seals.

CAUTION: Do not use silicone-based lubricants, which can have adverse effects on electrical components.

WARNING!

The distributor ignition system operates at very high voltages. Special safety precautions must be followed to prevent injury.

Always turn the ignition off when:

- connecting engine test and diagnostic equipment to the vehicle (timing light, tach-dwell tester, ignition oscilloscope, etc..).
- Replacing distributor ignition components e.g. plugs, coil, etc..
- Do not touch any part of the distributor ignition system while the engine is running. This may result in unintended movements and body injury.

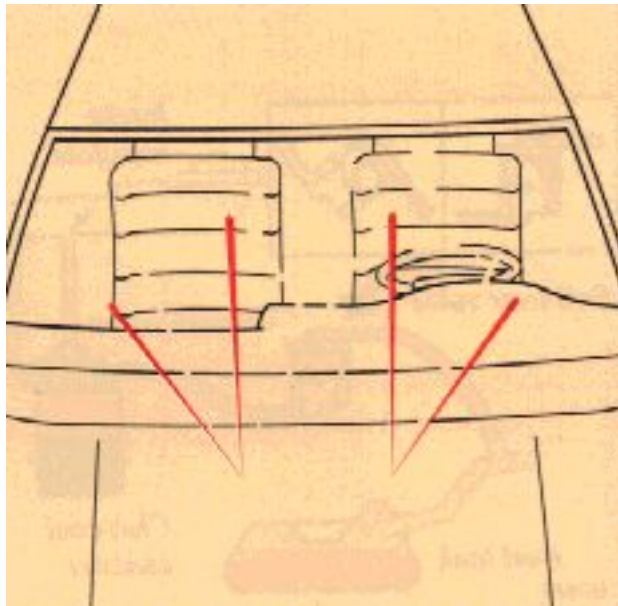

Adjusting washer nozzles

The washer jets should spray the windshield as shown. Use the edge of a small screwdriver to adjust the nozzles, if necessary.

Washer fluid reservoir

The washer fluid reservoir is located in the engine compartments and holds approx. 0.5 US gal. (2 liters) - sedans and 0.8 US gal (3.2 liters) - wagons. During cold weather, the reservoir should be filled windshield washer solvent containing anti-freeze.



[Contents](#) | [Top of Page](#)

Specifications

pg. 9:1 Specifications

Specifications

This chapter contains facts and figures pertaining to the technical specifications of your car.

- [9:2](#) Oil/Fluids specifications
- [9:3](#) Engine specifications
- [9:4](#) Cooling system
- [9:4](#) Fuel system
- [9:4](#) Distributor ignition system
- [9:5](#) Transmission
- [9:5](#) Suspension
- [9:6](#) Electrical system/bulbs
- [9:7](#) Capacities
- [9:8](#) Service manuals, Road assistance
- [9:9](#) Dimensions and weights
- [9:10](#) Customer support

pg. 9:2 Oil/Fluids Specifications

Oil quality

Meeting API specification SG

For best fuel economy and engine protection, consult with your authorized Volvo retailer for recommended oils. Oil with designation SG/CD complies with this requirement. Oil with a different quality rating may not provide adequate engine protection.

Volvo recommends the use of fuel economy improving oils. Look for the API label.

Synthetic oils complying with oil quality requirements are recommended for : driving in areas of sustained temperature extremes (hot or cold), when towing a trailer over long distances or for prolonged driving in mountainous areas.

Volvo does not recommend oil additives as they can adversely affect the engine

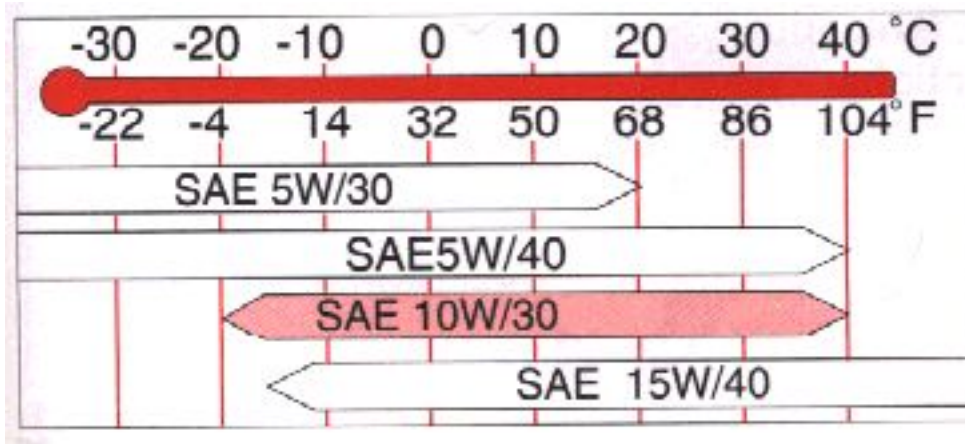

960 (6 cyl. engine)

Capacity (including filter) : 5.9 US qts = 5.75 liters

SAE 15 W/40 oil is recommended for use in severe driving conditions which involve high oil temperatures or excessive oil consumption (e.g. mountain driving with frequent deceleration, or high-speed driving.)

Automatic transmission fluid	Quality : ATF Dexron IIE/III and Mercon	Capacity : 7.9 US qts. (7.5 liters)
Rear axle oil	Quality : API-GL-5 (MIL-L-2105 C or D) SAE 80W-90	Capacity : 1.7 US qts. (1.6 liters) wagons 1.4 US qts (1.3 liters) sedans/wagons
Power steering fluid	Quality : ATF	Capacity : 1.05 US qts. (1.0 liters)
Brake fluid	Brake fluid type : DOT 4+	Capacity : 0.63 US qts. (0.6 liters)

All specifications are subject to change without notice.

pg. 9:3 Specifications

Engine

Liquid-cooled, gasoline, 6-cylinder, in-line engine. Aluminum alloy cylinder block with cast-iron cylinder liners cast directly into block. Aluminum alloy cylinder head with double overhead camshafts and separate intake and outlet channels.

Engine lubrication is provided by an eccentric pump driven from the crankshaft. Full-flow type oil filter. Exhaust emission control accomplished by fuel injection, heated oxygen sensors and three-way catalytic converter

Type designation Volvo B 6304 S 6 cyl.

Output (SAE J 1349) 201 hp at 6000 rpm
(150 kW at 100rps)

Max. torque (SAE J 1349) at rpm 197 ft. lbs. (267 Nm) at 4300 rpm

Number of cylinders 6

Bore 3.27" (83 mm)

Stroke 3.54" (90 mm)

Displacement 2.92 liters

Compression ratio 10.7:1

Valve clearance: Self-adjusting

All specifications are subject to change without notice.

pg. 9:4 Specifications

(Engine B 6304 S 6-cyl.)

Cooling system

Type: Positive pressure, closed system

Thermostat-begins to open at 186°F (87°C)

Coolant: Volvo Genuine Coolant/Anti-freeze

Capacity: 10.5 qts (10 liters)

Fuel system

The engine is equipped with a multiport fuel injection system

Distributor ignition System

Firing order 1-5-3-6-2-4

Distributor ignition setting 5° +/- 2° B.T.D.C. (at 700-800 rpm)

Spark plugs Bosch HR 6 DC (or equivalent)

Spark plug gap 0.024-0.028" (0.6-0.7 mm)

Tightening torque 17.3-20.3 ft. lbs. (23-27 Nm)

POWER TRANSMISSION

Automatic transmission: AW 30/4

Reduction ratios:

1st gear 2.80:1

2nd gear 1.53:1

3rd gear 1:1

Overdrive 0.71:1

Reverse 2.39:1

Rear axle:

Reduction ratio 3.31:1

All specifications are subject to change without notice.

Front suspension

McPherson-type spring and strut suspension. Shock absorbers housed in strut casing. Rack-and-pinion steering.

Safety-type steering column.

The alignment specifications apply to an unladen car, but include fuel, coolant, and spare wheel.

Toe-in, measured on the wheel rim: 2.1 mm +/- 0.9 mm

tire sides: 2.3 +/- 1.2 mm

Rear Suspension

Sedans: Multi-link rear wheel suspension consisting of four elements per side: a trailing support arm with load leveling shock absorber, an upper L-shaped link, a lower traverse link, and an angled rear rod to control wheel toe-in.

Toe-in, measured at the wheel rim: 0.016" +/- 0.020" (0.4 +/- 0.5 mm)

tire sides: 0.02" +/- 0.031" (0.5 +/- 0.8mm)

Wagons: Constant track rear axle located by two trailing support arms and a track rod. Equipped with coil springs and load-leveling shock absorbers. Torque forces controlled by two separate torque rods connected to rubber-insulated subframe.

ELECTRICAL SYSTEM

12 V, negative ground.

Voltage-controlled generator. Single-wire system with chassis and engine used as conductors.

Battery

Voltage 12 V

Battery, type Maintenance free

Capacity 600 A/125 min

Generator, rated output 1400 W

max. current 120 Amp

The battery contains corrosive and poisonous acids. It is of the utmost importance that old batteries are disposed of correctly. Your Volvo retailer can assist you in this matter.

Bulbs

Bulb	Trade No.	Power	Socket	No. of bulb
Headlights	HB1/9004	65/45 W	-	2
Parking lights,				
turn signals, front	1157 N. A.	21/5 W/24/2.2 cp	BAY 15	2
turn signals, rear	1156	21W/32cp	BA 15s	2
Tail lights	2x67	5 W/4cp	BA 15s	2
Brake light	1156	21 W/32cp	BA 15s	2*
Tail light/Brake light	1157	21/5W/32/3cp	BA 15d	2**
High-mounted brake light	1156	21 W/32cp	BA 15s	1
Back-up lights	1156	21 W/32cp	BA 15s	2
Rear fog light	1156	21 W/32cp	BA 15s	1
Front fog lights	GE881	27 W	-	2

* Sedan

** Wagon

The following bulbs may be obtained from your nearest Volvo retailer:

Bulbs	Power	Socket	No. of bulbs
License plate light (wagon)	4 W	BA 9s	2
(sedan)	5 W	W 2.1x9.5d	2
Door warning lights	3 W	W 2.1x9.5d	4
Interior light	10 W	SV8.5	1
Reading lights, front	5 W	W 2.1x9.5d	2
rear	5 W	W 2.1x9.5d	2
Trunk light	10 W	SV8.5	1
Glove box light	2 W	BA9 s	1
Instrument lighting	3 W	W 2.1x9.5d	3
Ashtray rear	1.2 W	Volvo P/ N966326	1
Seat belt lock	1.2 W	Volvo P/ N966326	1
Instrument warning/ indicator lights	1.2 W	Volvo P/ N966326	-

All specifications are subject to change without notice



[Contents](#) | [Top of Page](#)

Vehicle Loading

The tires on your Volvo should perform to specifications at all normal loads when inflated as recommended on the tire information label. The label is located on the rear-facing edge of the right-front door. This label lists both tire and vehicle design limits. Do not load your car beyond the load limits indicated.

Sample Tire Pressure Label

VEHICLE CAPACITY WEIGHT	OCCUPANTS			COLD TIRE PRESSURE	
	PRT	RR	TOTAL	FRONT	REAR
MAX. LOAD	2	3	5		PSI
RECOMMENDED FOR FUEL ECONOMY					
OPTIONAL PRESSURE					
TIRE SIZE	2	1	3		PSI
<small>* TIRE USE NOT RECOMMENDED FOR OFF-ROAD USE. ALWAYS INFLATE TO CORRECT PRESSURE.</small>					
	SIZE	LOAD INDEX	MAXIMUM PRESSURE		PSI
SEE OWNER'S MANUAL FOR ADDITIONAL INFORMATION					
VOLVO					

WARNING!

Improperly inflated tire will reduce tire life, adversely affect vehicle handling and can possibly lead to failure resulting in loss of vehicle control prior warning.

All specifications are subject to change without notice.

Capacities

Fuel tank (approx.) Wagon:

19.8 US gal.

75 liters

Sedan:

21.1 US gal.

80 liters

Cooling System 10.5 US qts.

10 liters

Engine 5.9 US qts. *
at oil change 5.75 liters
Engine, 5.5 US qts. *
excl. oil filter 5.15 liters
Automatic transmission 7.9 US qts.
7.5 liters
Rear axle Wagon:
1.8 US qts.
1.7 liters
Sedan:
1.4 US qts.
1.3 liters
Power steering gear 0.8 US qts.
0.8 liter
* if oil cooler is drained, add 0.47 US qts (0.4 liter)

pg. 9:8 Service manuals, Road assistance

Service Manuals for your Volvo are available for purchase. These are the same manuals used by competent Volvo technicians.

Major sections within the Service Manual System include: 0-General Information; 1- Lubrication and Service; 2- Engine; 3- Electrical System; 4- Power Transmission; 5-Brakes; 6- Suspension and Steering; 7- Springs Shock Absorbers and Wheels; 8- Body and Interior.

A Literature Catalog Request Card was placed in the car prior to delivery from the retailer to you. Complete ordering information is provided

All specifications are subject to change without notice.



Volvo supports Voluntary Mechanic Certification by the A.S.E. Certified mechanics have demonstrated a high degree of competence in specific areas. Besides passing exams each mechanic must also have worked in the field for two or more years before a certificate is issued. These professional mechanics are fully able to analyze vehicle problems and perform the necessary service procedures to keep your Volvo at peak operating condition.

Note that the above pertains to USA only.



Your new Volvo comes with a four year road assistance program named ON-CALL. Additional information, features, and benefits are described in a separate information package in your glove compartment.

pg. 9:9 Specifications

Dimensions and weights

U.S.A. and Canada

Length (sedan) 188.4 in (487.1 cm)

Length (wagon) 190.7 in (484.4 cm)
width 69.3 in (175 cm)
Height, Sedan 55.5 in (141 cm)
Wagon 56.7 in (144 cm)
Wheelbase 109 in (277 cm)
Track, front 57.8 in (147 cm)
Sedan rear 59.8 in (152 cm)
Wagon rear 57.5 in (146 cm)
Turning circle, (between curbs) 32.5 ft. (9.9 m)
Trunk capacity (sedans) 17.2 cu. ft. (0.49 m Cargo capacity (wagons)
with rear seat up 39.3 cu. ft. (1.1 m)
with rear seat down 74.9 cu. ft. (2.1 m)
Curb weight (sedan) 3505 lbs (1591 kg) 3498 lbs(1590 kg)
Curb weight (wagon) 3449 lbs (1566 kg) 3443 lbs(1565 kg)
Gross vehicle weight (sedan) 4440 lbs (2014 kg) 4443 lbs(2015 kg)
Gross vehicle weight (wagon) 4500 lbs (2041 kg) 4499 lbs(2045 kg)
Capacity Weight (sedan)* 920 lbs (418 kg) 924 lbs(420 kg)
Capacity Weight (wagon)* 1025 lbs (465 kg) 1045 lbs (475kg)
Permissible axle weight, front (sedan) 2165 lbs (982 kg) 2167 lbs(985 kg)
front (wagon) 2135 lbs (968 kg) 2134 lbs(970 kg)
rear (sedan) 2325 lbs (1055 kg) 2321 lbs(1055 kg)
rear (wagon) 2405 lbs (1091kg) 2420 lbs(1100 kg)
Max. roof load ** 220lbs (100 kg)
Max. trailer weight (w/o brakes) 1540 lbs (700 kg)
Max. trailer weight (with brakes - 2" ball) 3300 lbs (1500 kg)
Max. trailer weight (with brakes - 1 7/8" ball) 2000lbs (908 kg)
Max. trailer tongue weight 165 lbs (75 kg)

See also section "Trailer hauling".

* The max permissible axle loads or gross vehicle weight must not be exceeded.
Consult your Volvo retailer for information.

WARNING:

When adding accessories, equipment, luggage and other cargo to your vehicle, the total loaded weight capacity of the vehicle must not be exceeded.

All specifications are subject to change without notice.

pg. 9:10 Customer Support

Vehicle Information (see "Label information" section)

Vehicle License Number

Vehicle Identification Number (VIN)

Service Designation Number

Engine Designation (See "Specifications" section)

Color code

Upholstery

Tire designation (See "Tires" section)

Vehicle capacity

Do not export your Volvo to another country before investigating that country's applicable safety and exhaust emission requirements. In some cases it may be difficult or impossible to comply with these requirements. Modifications to the emission control system(s) may render your Volvo not certifiable for legal operation in the U.S., Canada and other countries.

Inside back cover

WARNING!**Detergents and solvents**

Do not use gasoline containing lead or benzene as a detergent or solvent. Both lead and benzene are toxic and may be hazardous to your health.

Installation of optional equipment/use of mobile telephones

Incorrectly installed optional equipment, alarm systems or the use of mobile telephones which are not connected to a suitable antenna can cause faults in the car's electronic control systems. Your car is equipped with an accessory connector located under the dashboard on the driver's side. Please consult your Volvo retailer if you have any questions before connecting accessory or optional equipment to the vehicle's electrical systems.

Carbon monoxide

Carbon monoxide is a poisonous, colorless and odorless gas which is present in all exhaust gases. If you ever smell exhaust fumes from inside the vehicle, make sure the passenger compartment is ventilated and immediately return the vehicle to your retailer for correction.

Never sit in a parked or stopped car for any extended amount of time, nor have it unattended while the engine is running.

Never operate the engine in confined, unventilated areas.

Back Cover

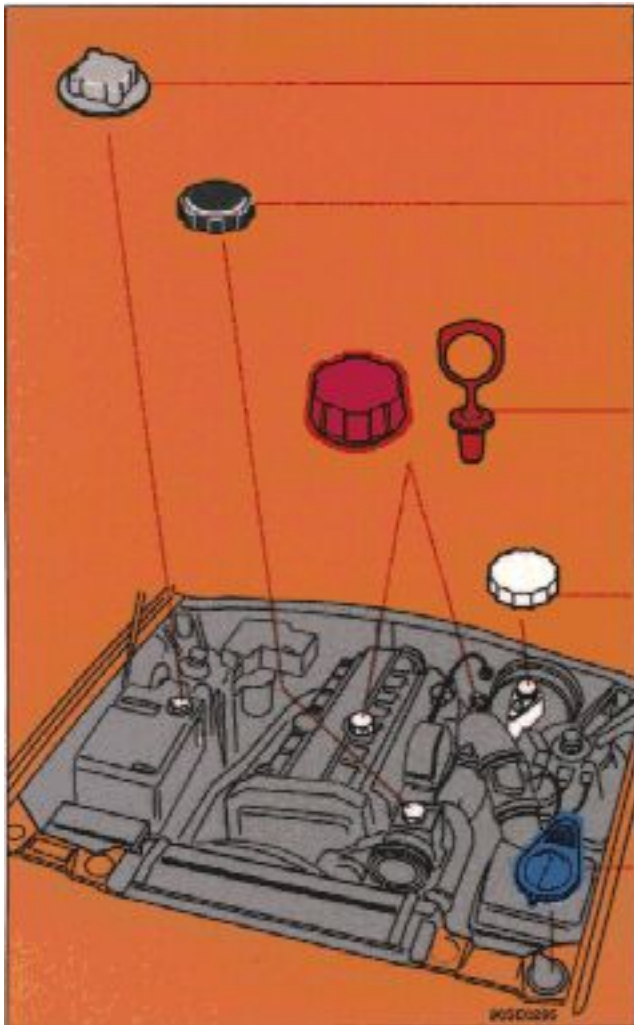

Coolant level should be between the expansion tank marks. Mixture 50% anti-freeze and 50% water. See page 8:17.

Power steering - When cold, the level must not be above the COLD mark and when hot it must not be above the HOT mark. Top up if the level drops to the ADD mark with ATF fluid. See page 8:15.

Oil level should be between the dipstick marks. The distance between the marks represents approx. 1 US qt. = 1 liter. See page 8:6.

Brake fluid - check, without removing the cap, that the level is above the MIN-mark. Brake fluid DOT 4+. See page 8:15.

Washer fluid reservoir should be filled with water and solvent (wintertime: windshield washer anti-freeze). See page 8:12.



Octane rating, see p. 4:3.

Tire pressure, see label located on rear edge of right front door.

Bulbs	Power	Socket	US Bulb No.
1	45/65 W		9004

2	27 W		GE881
3	5 W	BA 15s	67
4	21 W	BA 15s	1156
5	21/5 W	BAY 15d	1157

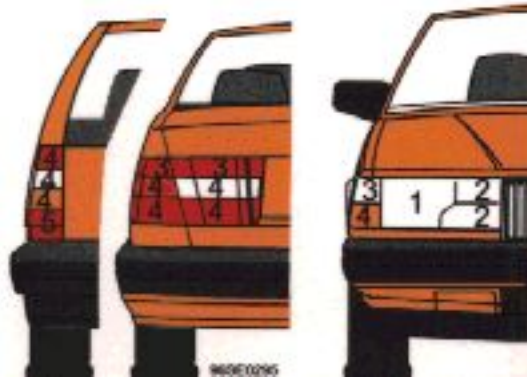

VOLVO
Volvo Car Corporation
Goteborg, Sweden

TP 3362/2 (Canada & U.S.A.) 7000.9.9



[Contents](#) | [Top of Page](#)