

# Installation Manual

## PLEASE READ BEFORE USE AND SAVE.

This handset is an accessory cordless handset, for use with Panasonic base units KX-TG5100/KX-TG5110. This installation manual only describes the steps necessary to start up the handset. Please read the KX-TG5100/KX-TG5110 operating instructions for further details.

**Accessories** (included) For extra orders, call 1-800-332-5368.

- |  |  |
|--|--|
| <input type="checkbox"/> Charger Unit . . . . . one  | <input type="checkbox"/> Battery . . . . . one   |
| Charger Order No. PQLV30019ZM                        | Order No. P-P511                                 |
| AC Adaptor Order No. KX-TCA1-G (KX-TCA1)             | <input type="checkbox"/> Belt Clip . . . . . one |
| <input type="checkbox"/> Handset Cover . . . . . one | Order No. PQKE10363Z1                            |
| Order No. PQKK10137Z1                                |  |

## Installation

### Connecting the Charger unit

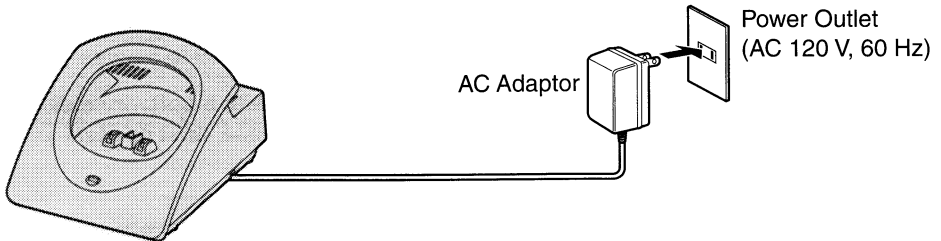

- USE ONLY WITH Panasonic AC ADAPTOR KX-TCA1 (Order No. KX-TCA1-G).
- The AC adaptor must remain connected at all times. (It is normal for the adaptor to feel warm during use.)

### Installing the battery

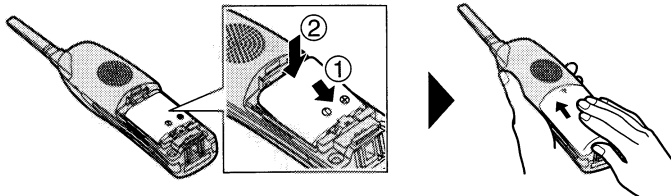

Insert the battery (①), and press it down until it snaps into the compartment (②). When finished, close the cover.



For assistance, please call: 1-800-211-PANA(7262)

## Charging the battery

Place the handset on the charger and charge for **about 6 hours** before initial use.

- The unit beeps once, the CHARGE indicator lights and “Charging” is displayed.
- When the battery is fully charged, “Charge completed” is displayed if there are no new calls in the Caller List.
- Recharge the battery when:
  - “Recharge battery” is displayed,
  - “” flashes on the display, or
  - the handset beeps intermittently while it is in use.
- If the battery has been discharged, the handset will display “Charge for 6 HRS” and “” when you place the handset on the charger. The handset will not work unless the battery is charged. Keep charging.

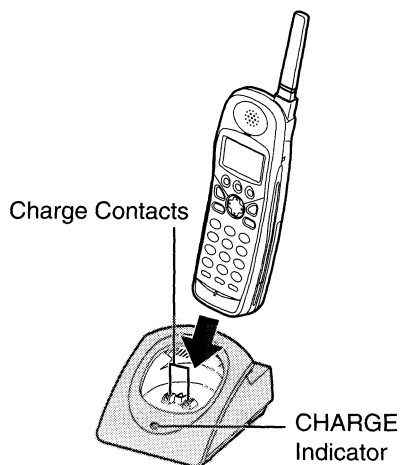

## Handset battery information

After your Panasonic battery is fully charged:

Operation	Operating time
While in use (TALK)	Up to 4.5 hours
While not in use (Standby)	Up to 11 days
While using the Reception Booster feature	Up to 3 hours

- **Clean the charge contacts of the handset and the charger with a soft, dry cloth once a month. Clean more often if the unit is subject to grease, dust or high humidity.** Otherwise the battery may not charge properly.

## Belt Clip

You can hang the handset on your belt or pocket using the belt clip.

### To attach the belt clip

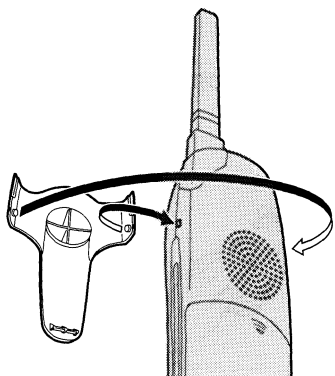

### To remove the belt clip

While pressing the top of the clip (A), pull the right edge in the direction of the arrow (B).

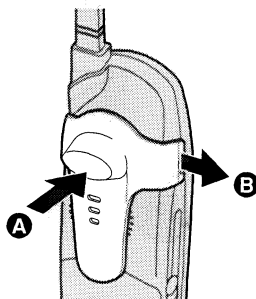

# Registration

This cordless handset must be registered to a KX-TG5100/KX-TG5110 base unit. The handset will be assigned the extension number at registration. Only one handset can be registered at a time.

**Charge the battery fully. Make sure the base unit and the other handsets are not being used. Registration must be completed within 1 minute.**

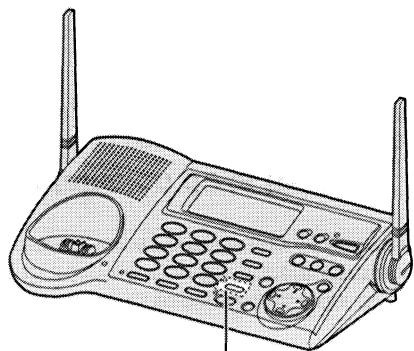

[MUTE] Button and Indicator



To operate "OK", press the right soft key.

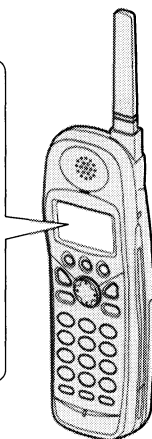

The handset display shows the instructions as shown on the right.

Press MUTE on base unit, then OK on handset to register handset  
**OK**

## 1 Base unit: Press [MUTE].

- The MUTE indicator flashes.

## 2 Handset:

- (1) Press the soft key (**OK**).

- (2) Wait until a long beep sounds and the display shows the registered number.

- Registration is complete.

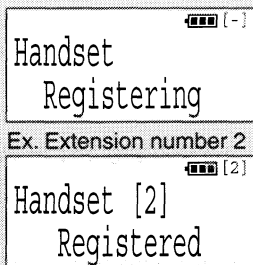

- The registered number "[1]" to "[8]" is shown on the top right of the display.
- You can stop registration by pressing [OFF] on the handset and pressing [MUTE] on the base unit.

To cancel the handset registration, please see the KX-TG5100/KX-TG5110 Operating Instructions.

**For assistance, please call: 1-800-211-PANA(7262)**

# Optional Headset

Plugging the optional headset into the handset allows for hands-free phone conversation. Please use only a Panasonic KX-TCA60, KX-TCA86, KX-TCA88, KX-TCA91, KX-TCA92 or KX-TCA98. To order, call the accessories telephone number on page 1.

## Connecting an optional headset

Open the headset jack cover, and connect the optional headset to the headset jack as shown below.

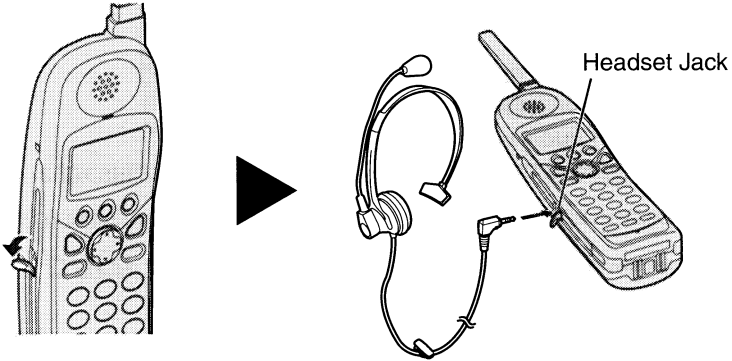

- Headset sold separately. Model shown here is KX-TCA88.

# Wall Mounting

The charger can be wall mounted. Connect the AC adaptor. Install screws using the wall template (see below). Mount the charger (1). Slide it down (2), then slide down to the right (3) until it is secured.

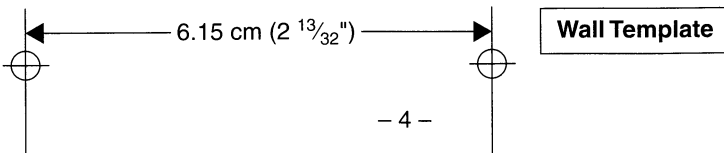
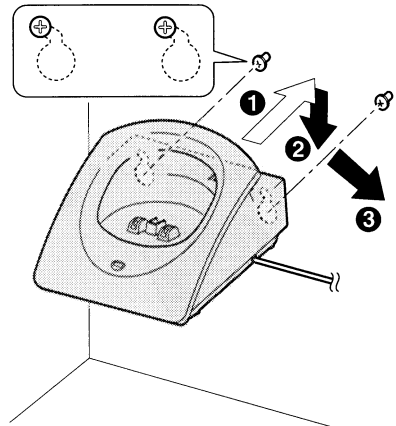
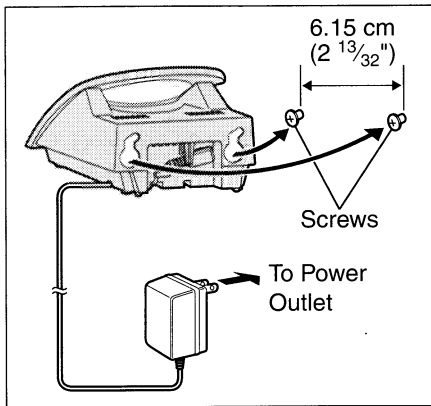

## **FCC and Other Information**

WHEN PROGRAMMING EMERGENCY NUMBERS AND/OR MAKING TEST CALLS TO EMERGENCY NUMBERS:

1. Remain on the line and briefly explain to the dispatcher the reason for the call.
2. Perform such activities in the off-peak hours, such as early morning or late evenings.

This device complies with Part 15 of the FCC Rules. Operation is subject to the following two conditions: (1) This device may not cause harmful interference, and (2) this device must accept any interference received, including interference that may cause undesired operation.

Privacy of communications may not be ensured when using this phone.

### **CAUTION:**

Any changes or modifications not expressly approved by the party responsible for compliance could void the user's authority to operate this device.

### **Note:**

This equipment has been tested and found to comply with the limits for a Class B digital device, pursuant to Part 15 of the FCC Rules. These limits are designed to provide reasonable protection against harmful interference in a residential installation. This equipment generates, uses, and can radiate radio frequency energy and, if not installed and used in accordance with the instructions, may cause harmful interference to radio communications. However, there is no guarantee that interference will not occur in a particular installation. If this equipment does cause harmful interference to radio or television reception, which can be determined by turning the equipment off and on, the user is encouraged to try to correct the interference by one or more of the following measures:

- Reorient or relocate the receiving antenna.
- Increase the separation between the equipment and receiver.
- Connect the equipment into an outlet on a circuit different from that to which the receiver is connected.
- Consult the dealer or an experienced radio/TV technician for help.

Operating near 5.8GHz electrical appliances may cause interference. Move away from the electrical appliances.

### **CAUTION:**

To comply with FCC RF exposure requirements, the base unit should be installed with its antenna located at 20 cm or more from persons and handset should be carried with the specific belt-clip provided for the handset to ensure compliance. Other non-tested belt-clips or similar body-worn accessories may not comply, therefore, should be avoided.

This equipment is hearing aid compatible as defined by the FCC in 47 CFR Section 68.316.

When you hold the phone to your ear, noise might be heard in your Hearing Aid. Some Hearing Aids are not adequately shielded from external RF (radio frequency) energy. If noise occurs, use an optional headset accessory or the speakerphone option (if applicable) when using this phone. Consult your audiologist or Hearing Aid manufacturer about the availability of Hearing Aids which provide adequate shielding to RF energy commonly emitted by digital devices.

**For assistance, please call: 1-800-211-PANA(7262)**

## CAUTION:

To reduce the risk of fire or injury to persons, read and follow these instructions.

1. Use only the battery(ies) specified.
2. Do not dispose of the battery(ies) in a fire. They may explode. Check with local waste management codes for special disposal instructions.
3. Do not open or mutilate the battery(ies). Released electrolyte is corrosive and may cause burns or injury to the eyes or skin. The electrolyte may be toxic if swallowed.
4. Exercise care in handling batteries in order not to short the battery to conductive materials such as rings, bracelets, and keys. The battery and/or conductor may overheat and cause burns.
5. Charge the battery(ies) provided with or identified for use with this product only in accordance with the instructions and limitations specified in this manual.

A nickel cadmium battery that is recyclable powers the product you have purchased. At the end of its useful life, under various state and local laws, it is illegal to dispose of this battery into your municipal waste stream. Please call 1-800-8-BATTERY for information on how to recycle this battery.



## WARNING:

TO PREVENT FIRE OR SHOCK HAZARD, DO NOT EXPOSE THIS PRODUCT TO RAIN OR ANY TYPE OF MOISTURE.

- The AC adaptor is used as the main disconnect device, ensure that the AC outlet is located/installed near the unit and is easily accessible.

### For your future reference

Serial No.

Date of purchase

(found on the bottom of the unit)

Name and address of dealer

**If you need assistance with the set-up or operation,  
please call 1-800-211-PANA(7262)**

**Panasonic World Wide Web address: <http://www.panasonic.com>**  
for customers in the USA or Puerto Rico

Panasonic's e-mail address for customer inquiries:  
[consumerproducts@panasonic.com](mailto:consumerproducts@panasonic.com)

**Panasonic Consumer Electronics Company,  
Division of Matsushita Electric Corporation of America**  
One Panasonic Way, Secaucus, New Jersey 07094

**Panasonic Sales Company,  
Division of Matsushita Electric of Puerto Rico, Inc.**  
Ave. 65 de Infantería, Km. 9.5, San Gabriel Industrial Park  
Carolina, Puerto Rico 00985

**PANASONIC CONSUMER  
ELECTRONICS COMPANY, DIVISION  
OF MATSUSHITA ELECTRIC  
CORPORATION OF AMERICA  
One Panasonic Way  
Secaucus, New Jersey 07094**

**PANASONIC SALES COMPANY,  
DIVISION OF MATSUSHITA  
ELECTRIC OF PUERTO RICO, INC.,  
Ave. 65 de Infanteria, Km. 9.5  
San Gabriel Industrial Park  
Carolina, Puerto Rico 00985**

## **Panasonic Telephone Products Limited Warranty**

### **Limited Warranty Coverage**

If your product does not work properly because of a defect in materials or workmanship, Panasonic Consumer Electronics Company or Panasonic Sales Company (collectively referred to as "the warrantor") will, for the length of the period indicated on the chart below, which starts with the date of original purchase ("warranty period"), at its option either (a) repair your product with new or refurbished parts, or (b) replace it with a new or a refurbished product. The decision to repair or replace will be made by the warrantor.

<b>Parts</b>	<b>Labor</b>
<b>One (1) Year</b>	<b>One (1) Year</b>

During the "Labor" warranty period there will be no charge for labor. During the "Parts" warranty period, there will be no charge for parts. You must mail-in your product during the warranty period. This Limited Warranty excludes both parts and labor for batteries, antennas, and cosmetic parts (cabinet). This warranty only applies to products purchased and serviced in the United States or Puerto Rico. This warranty is extended only to the original purchaser of a new product which was not sold "as is".

### **Mail-In Service**

For assistance in the continental U.S.A. in obtaining repairs please ship the product to:

**Panasonic Services Company  
Customer Servicercenter  
Suite B  
4900 George McVay Drive  
McAllen, TX 78503**

For assistance in Puerto Rico call Panasonic Sales Company (787)-750-4300 or fax (787)-768-2910.

When shipping the unit carefully pack and send it prepaid, adequately insured and preferably in the original carton. Include a letter detailing the complaint and provide a day time phone number where you can be reached.

**IF REPAIR IS NEEDED DURING THE WARRANTY PERIOD THE PURCHASER WILL BE REQUIRED TO FURNISH A SALES RECEIPT/PROOF OF PURCHASE INDICATING DATE OF PURCHASE, AMOUNT PAID AND PLACE OF PURCHASE. CUSTOMER WILL BE CHARGED FOR THE REPAIR OF ANY UNIT RECEIVED WITHOUT SUCH PROOF OF PURCHASE.**

### **Limited Warranty Limits And Exclusions**

This warranty ONLY COVERS failures due to defects in materials or workmanship, and DOES NOT COVER normal wear and tear or cosmetic damage. The warranty ALSO DOES NOT COVER damages which occurred in shipment, or failures which are caused by products not supplied by the warrantor, or failures which result from accidents, misuse, abuse, neglect, mishandling, misapplication, alteration, faulty installation, set-up adjustments, misadjustment of consumer controls, improper maintenance, power line surge, lightning damage, modification, introduction of sand, humidity or liquids, commercial use such as hotel, office, restaurant, or other business or rental use of the product, or service by anyone other than a Factory Servicer or other Authorized Servicer, or damage that is attributable to acts of God.

**THERE ARE NO EXPRESS WARRANTIES EXCEPT AS LISTED UNDER "LIMITED WARRANTY COVERAGE". THE WARRANTOR IS NOT LIABLE FOR INCIDENTAL OR CONSEQUENTIAL DAMAGES RESULTING FROM THE USE OF THIS PRODUCT, OR ARISING OUT OF ANY BREACH OF THIS WARRANTY.** (As examples, this excludes damages for lost time, lost calls or messages, cost of having someone remove or re-install an installed unit if applicable, travel to and from the servicer. The items listed are not exclusive, but are for illustration only.) **ALL EXPRESS AND IMPLIED WARRANTIES, INCLUDING THE WARRANTY OF MERCHANTABILITY, ARE LIMITED TO THE PERIOD OF THE LIMITED WARRANTY.**

Some states do not allow the exclusion or limitation of incidental or consequential damages, or limitations on how long an implied warranty lasts, so the exclusions may not apply to you.

This warranty gives you specific legal rights and you may also have other rights which vary from state to state. If a problem with this product develops during or after the warranty period, you may contact your dealer or Servicer. If the problem is not handled to your satisfaction, then write to the warrantor's Consumer Affairs Department at the addresses listed for the warrantor.

**PARTS AND SERVICE, WHICH ARE NOT COVERED BY THIS LIMITED WARRANTY, ARE YOUR RESPONSIBILITY.**

## ***Customer Services Directory***

***For Product Information, Operating Assistance, Literature Request, Dealer Locations, and all Customer Service inquiries please contact: 1-800-211-PANA (7262), Monday-Friday 9 am-9 pm; Saturday-Sunday 10 am-7 pm, EST. or send e-mail : consumerproducts@panasonic.com For hearing or speech impaired TTY users, TTY : 1-877-833-8855***

***Web Site: <http://www.panasonic.com>  
You can purchase parts, accessories or locate your nearest servicer by visiting our Web Site.***

### ***Accessory Purchases:***

**1-800-332-5368 (Customer Orders Only)**

**For hearing or speech impaired TTY users, TTY : 1-866-605-1277  
Panasonic Services Company 20421 84th Avenue South, Kent, WA 98032**

**(6 am to 5 pm Monday - Friday; 6 am to 10:30 am Saturday; PST)  
(Visa, MasterCard, Discover Card, American Express, Check)**

***Service in Puerto Rico  
Matsushita Electric of Puerto Rico, Inc. Panasonic Sales Company/  
Factory Servicer:***

***Ave. 65 de Infantería, Km. 9.5, San Gabriel Industrial Park,  
Carolina, Puerto Rico 00985***

***Phone (787)750-4300 Fax (787)768-2910***



# IMPORTANT!

Before you Return Product to the Retailer!

*If You Need Assistance With the Set-Up Or Operation  
We can Help! Call us FIRST at*

1-800-211-PANA (7262)

Toll Free

Monday—Friday 9am—9pm,

Saturday—Sunday 9am—7pm, EST

OR

Visit our Website: <http://www.panasonic.com>

1 Year Limited Warranty. Limits and exclusions apply. See details inside of box.