

Panasonic

Multimedia Portable CD-ROM with Sound

Model No. **KXL-D721**

Operating Instructions



Please read before using and store in a safe place.

End-User License Agreement

THIS IS A LEGAL AGREEMENT BETWEEN YOU AND PANASONIC CAREFULLY READ ALL THE TERMS AND CONDITIONS OF THIS AGREEMENT PRIOR TO OPENING THE PACKET OF SOFTWARE PROGRAM OPENING THE PACKET INDICATES YOUR ACCEPTANCE OF THESE TERMS AND CONDITIONS If you do not agree to these terms and conditions, return the unopened packet and the other components of the Panasonic product to the place of purchase and your money will be refunded No refunds will be given for the product that have an opened packet or missing components

1 COPYRIGHT

Panasonic has the right to license or has been granted to license the enclosed software program ("SOFTWARE"), developed and copyrighted by Kyushu Matsushita Electric Co , Ltd or its licensor ("Licensor") You acknowledge that you are receiving only a LIMITED LICENSE TO USE the SOFTWARE and related documentation, and that you shall obtain no title, ownership nor any other rights in or to the SOFTWARE and related documentation, all of which title and rights shall remain with Licensor and Panasonic

2 LICENSE

(1) You have the non-exclusive right to use the one copy of the SOFTWARE on a single computer used by single user Installation of the SOFTWARE on a network server for the purpose of distribution to one or more other computers shall not be granted in this Agreement (2) You may not copy, reproduce, or permit to be copied or reproduced, the SOFTWARE or related documentation for any purpose, except that you may either (a) make a reasonable quantity of copies of the SOFTWARE solely for backup or archival purposes, or (b) transfer the SOFTWARE to a single hard disk, provided that you keep the original solely for backup or archival purposes All other copies of the SOFTWARE are in violation of this Agreement (3) You may not rent or lease the SOFTWARE, but you may transfer your right under this License Agreement on a permanent basis, provided that you transfer this Agreement, all copies of the SOFTWARE, all related documentation and your Panasonic product, and the recipient thereof agrees the terms of this Agreement (4) You may not reverse engineer, decompile or disassemble the SOFTWARE, except that in European Union and European Free Trade Association, you may have the limited right to reverse engineer, decompile or disassemble the SOFTWARE solely to the extent specifically permitted by the terms and conditions of Article 6 of the European Community's Directive for the Legal Protection of Computer Programs, OJL 122/42 (17 May 1991) (5) You may not use, copy, modify, alter, or transfer the SOFTWARE, or any copy thereof, in whole or in part, except as expressly provided in this Agreement

3 TERM

This license is effective until terminated You may terminate this Agreement at any time by destroying the SOFTWARE and related documentation and all copies thereof This license will also terminate if you fail to comply with any term or condition of this Agreement Upon such termination, you agree to destroy all copies of the SOFTWARE and related documentation

4. LIMITED WARRANTY:

Within ninety (90) days of your receipt of the SOFTWARE, Panasonic warrants that the storage media on which the SOFTWARE are furnished is free from defect in materials and workmanship under normal use, and that it will repair or at its option replace any defective media at no charge to you, provided that such defective media is returned to Panasonic within such ninety (90) days period.

5. LIMITATION OF LIABILITY:

EXCEPT AS STATED ABOVE, NEITHER PANASONIC NOR PANASONIC'S SUPPLIER MAKES OR PASSES ON TO YOU OR OTHER THIRD PARTY, ANY WARRANTY OR REPRESENTATION INCLUDING, BUT NOT LIMITED TO, THE IMPLIED WARRANTY OF MERCHANTABILITY AND FITNESS FOR A PARTICULAR PURPOSE.

WITHOUT LIMITING THE GENERALITY OF THE FOREGOING, NEITHER PANASONIC NOR PANASONIC'S SUPPLIER WARRANTS THAT THE SOFTWARE WILL BE ERROR-FREE OR THAT IT WILL MEET YOUR REQUIREMENTS. NEITHER PANASONIC NOR PANASONIC'S SUPPLIER SHALL BE LIABLE FOR ANY DAMAGE SUFFERED BY YOU INCLUDING, BUT NOT LIMITED TO, CONSEQUENTIAL, INCIDENTAL SPECIAL OR PUNITIVE DAMAGES. THE ABOVE LIMITATIONS SHALL APPLY REGARDLESS OF THE FORM OF ACTION WHETHER IN CONTRACT, TORT (INCLUDING NEGLIGENCE), STRICT PRODUCT LIABILITY OR OTHERWISE, EVEN IF SUCH PARTY HAS BEEN ADVISED OF THE POSSIBILITY OF SUCH DAMAGES.

WARNING

- The power source voltage of this AC adaptor is listed on the nameplate. Plug the AC adaptor only into an outlet with the proper voltage.
- To prevent fire or shock hazard, do not expose this product to rain or any type of moisture.

CAUTION

- When you operate this equipment, the outlet should be near the equipment and should be easily accessible.
- To prevent the SCSI interface connector from static electricity damage, before you touch it, discharge any static electricity from your hands by touching a grounded metal surface, such as the screw on the plate cover of an electrical outlet.

IBM and PC DOS are trademarks of International Business Machines Corporation.

MS-DOS® and Windows® are registered trademarks of Microsoft Corporation.

Photo CD is a trademark of Eastman Kodak Company.

Sound Blaster is a trademark of Creative Technology Ltd.

YAMAHA is a trademark of Yamaha Co., Ltd.

Ad-Lib is a trademark of Ad Lib Inc.

All other brand and product names are trademarks or registered trademarks of their respective companies.

Any details given in these Operating Instructions are subject to change without notice.

All Rights Reserved, © COPYRIGHT 1995 KYUSHU MATSUSHITA ELECTRIC CO., LTD.

CAUTION FOR LASER

This product utilizes a laser

Use of control, adjustment or performance of procedures other than those specified herein may result in hazardous radiation exposure

Do not open covers and do not repair yourself. Refer servicing to qualified personnel

Laser diode properties

Material	GaAlAs
Laser output	Less than 44.6 μ W
Wave length	780 nm
Emission duration	Continuous

(This output is the value measured at the distance of 200 mm from the objective lens surface)

FOR USERS IN UNITED STATES ONLY

This equipment has been tested and found to comply with the limits for a Class B digital device, pursuant to Part 15 of FCC Rules. These limits are designed to provide reasonable protection against harmful interference in a residential installation.

This equipment generates, uses and can radiate radio frequency energy and, if not installed and used in accordance with the instructions, may cause harmful interference to radio communications.

However, there is no guarantee that interference will not occur in a particular installation. If this equipment does cause harmful interference to radio or television reception, which can be determined by turning the equipment off and on, the user is encouraged to try to correct the interference by one or more of the following measures:

- Reorient or relocate the receiving antenna.
- Increase the separation between the equipment and receiver.
- Connect the equipment into an outlet on a circuit different from that to which the receiver is connected.
- Consult the dealer or an experienced radio/TV technician for help.

The user may find the booklet "Something About Interference" available from FCC local regional offices helpful.

FCC Warning: To assure continued FCC emission limit compliance, the user must use only the recommended shielded interfacing cable when connecting to a host computer. Also, any unauthorized changes or modifications to this equipment would void the user's authority to operate this device.

Table of Contents

End-User License Agreement	2
--------------------------------------	---

Features	6
Accessories	6
Precautions	7
Part Names and Functions	8
Power Supply	11
Using supplied AC adaptor	11
Using batteries (not supplied)	11

Before using



Connection	12
Connecting player to computer	12
Connecting the speakers	13
Connecting the microphone	14
Connecting an audio connecting cable (not supplied)	14
Power On	15
Software Installation	16
Before installing software	16
Installing under Windows 3.1, 3.11	17
Installing under Windows 95	22
Installing Windows 95 using the player	24

Setup



Inserting/Removing a CD	25
CD-ROM/Audio CD Operation	26
CD-ROM Operation	26
Audio CD Operation	27

Operation



Error Messages on Computer	29
README File	30
Troubleshooting	31
SCSI ID Number and Terminator	33
Maintenance	34
Specifications	35
Index	38

General Information



Features

- Portable CD-ROM player with Sound for Notebook Computer
- Double Speed External Drive
Transfer Rate 300 KB/s
128 KB Memory Buffer
Access Time 295 ms with AC Adaptor
Operates on six (6) "AA" Batteries or AC Adaptor for Player
Plays Audio CD, Photo CD Multisession Compatible
- Compatible with Window 95, Plug and Play PCMCIA Interface Card (Type II)
- Sound Blaster FM Sound Source for Windows and DOS Ad-Lib Compatible
- 16 bit Quality Sound
- YAMAHA OPL3 Compatible FM Music Synthesizer
- Recording & Playback up to 44.1 kHz CD Quality Stereo Sound
- Microphone Included for Recording Voice Annotation
- Includes a Wide Array of Sound System Utilities & Audio Clip Library
- Includes 2 Compact Stereo Speakers by Battery Operation

Accessories

Make sure that the following accessories are included with the player

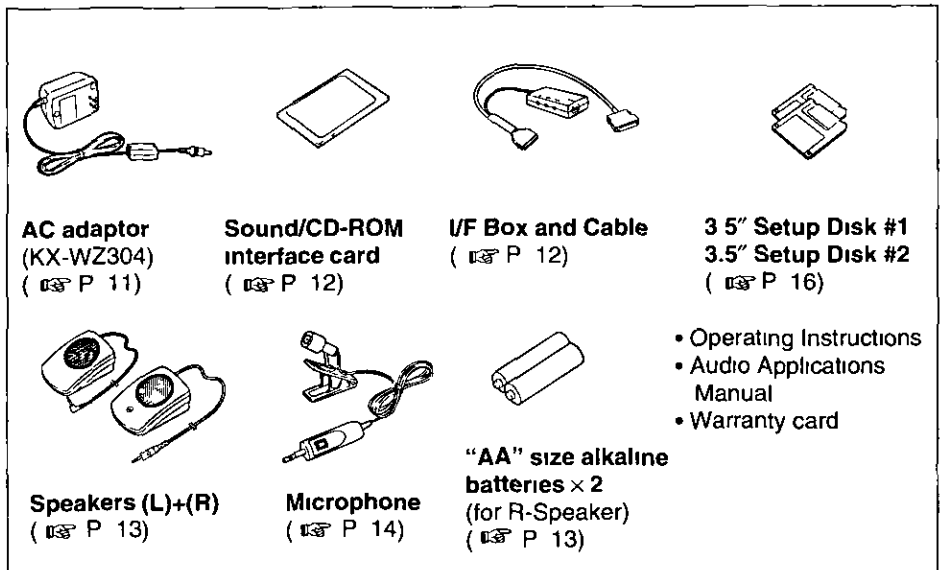

Precautions

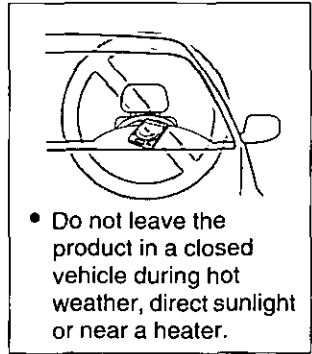
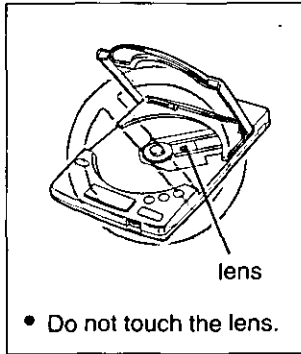
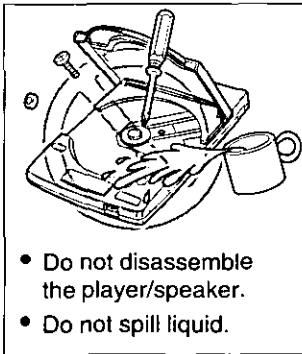
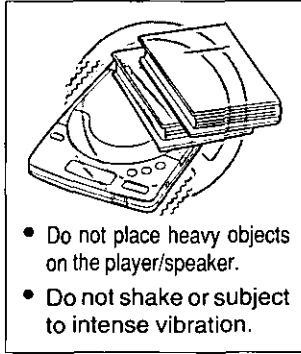
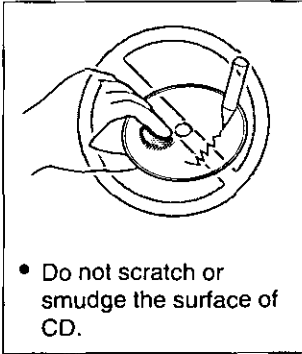

- Do not play CD-ROM/audio CD while transporting.
- Do not use near any appliance that may cause vibration.
- Do not place speaker near the appliance which has cathode-ray tube (CRT) display for a long period since the magnetism may affect the CRT.
- Do not crush Sound/CD-ROM Interface Card.

Important:

■ Please use CD-ROMs with the marking below.



■ Please use audio CDs with the marking below.



Part Names and Functions

Player



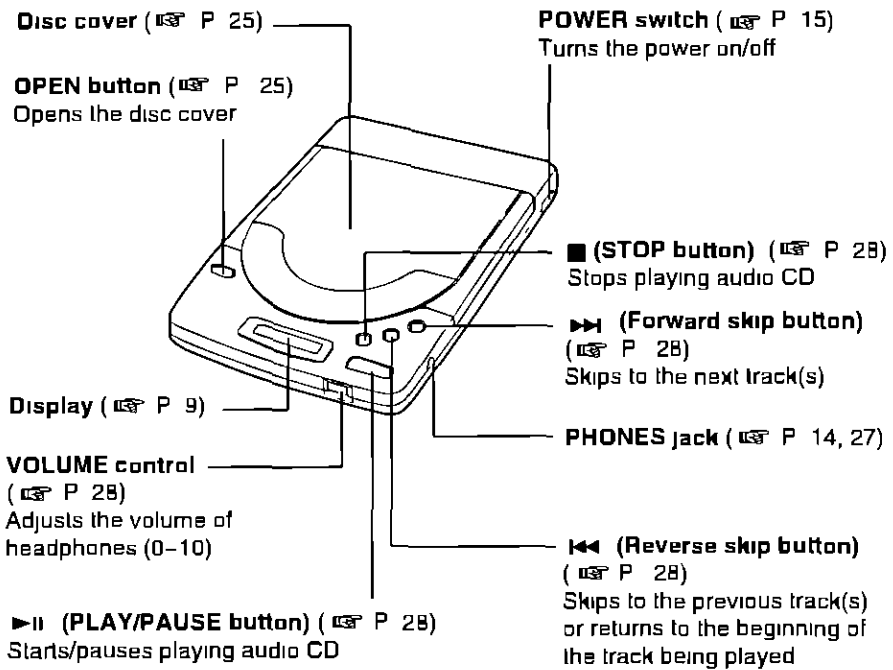



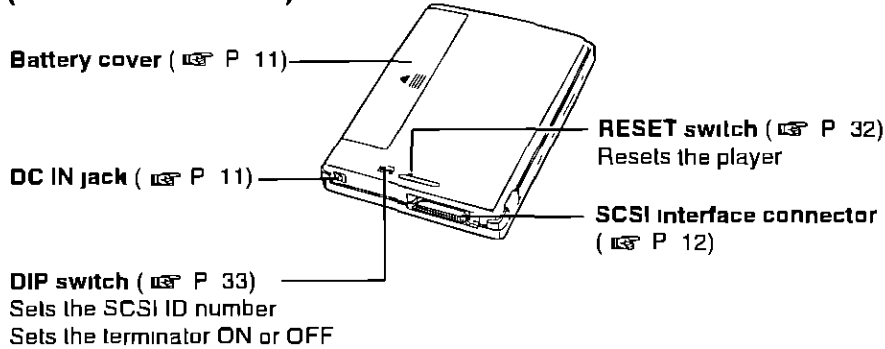

(Top view)

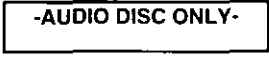

(Rear/Bottom view)

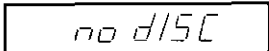
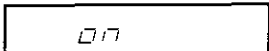

Display messages

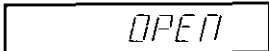
Message/Indication	Description
	With a CD-ROM inserted in the player, if you press  ,  ,  or  , a blinking message "AUDIO DISC ONLY" will appear
	When the battery is low, this blinking indication will appear
	When data from CD-ROM is sent to your computer, a blinking message "BUSY" will appear
	CD is not inserted, or the inserted CD is not recognized because either the CD is placed with the label side facing down, or it is damaged, dirty, wet, etc
	When CD-ROM is inserted, a message "on" is displayed. While CD-ROM or audio CD is recognizing, a blinking message "on" will appear
	Audio CD is recognized
	The disc cover is open



Part Names and Functions

I/F Box

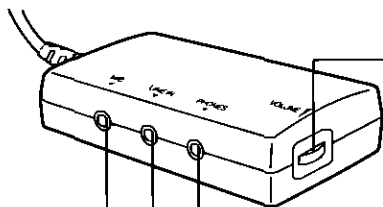

Volume control (P 13)
Adjusts the volume of the speaker or headphones (not supplied) connected to the PHONES jack (0-10)

PHONES jack (P 13)
Connects the supplied R-speaker or headphones (not supplied)

LINE IN jack (P 14)
Connects to the player's PHONES jack or to the output jack of an audio device by using a commercially available audio connecting cable

MIC jack (P 14)
Connects the supplied microphone for voice or music recording

Speakers

< L-speaker >

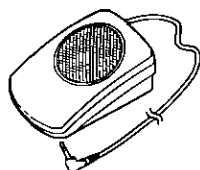

< R-speaker >

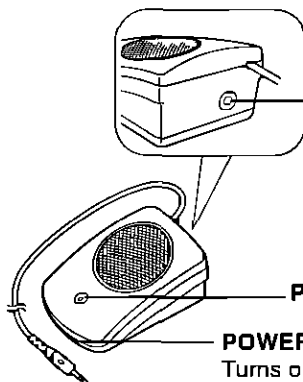

Jack (P 13)
Connects the L (LEFT)-speaker

Power indicator (P 13, 15)

POWER switch
Turns on (|)/off (○) the speaker

< Bottom of R-speaker >

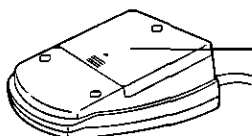

Battery cover (P 13)

Power Supply

This player can be used by using either supplied AC adaptor or batteries (not supplied).

Using supplied AC adaptor

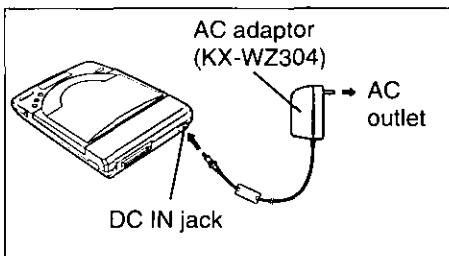

Connect one end of the AC adaptor to DC IN jack and the other end to household AC outlet.

Caution:

- Use only the supplied AC adaptor (KX-WZ304), since other adaptors may damage the player.

Using batteries (not supplied)

Alkaline batteries are recommended.

Battery Precautions:

If improperly used, the batteries may leak and cause corrosion. Therefore, observe the following:

- Install batteries according to the diagram.
- Do not mix old and new batteries, or carbon and alkaline battery types.
- Remove all batteries when not using the player for extended periods.
- Do not charge, short-circuit, disassemble, heat, or dispose of in fire.

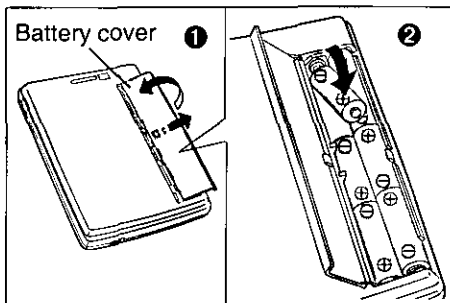

① Open the battery cover by sliding and lifting it up.

② Install six “AA” size batteries (not supplied).

Make sure the polarities (+, -) match the diagram.

■ Replacing the Batteries:

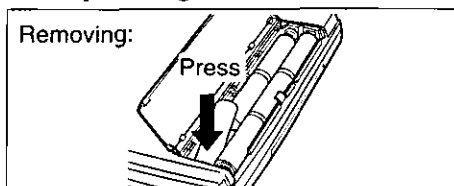

Replace the batteries when blinking mark “” appears on the display.



Connection

Connecting player to computer

Make sure that your notebook computer and the player are off and the player's terminator is set to ON (P 33)

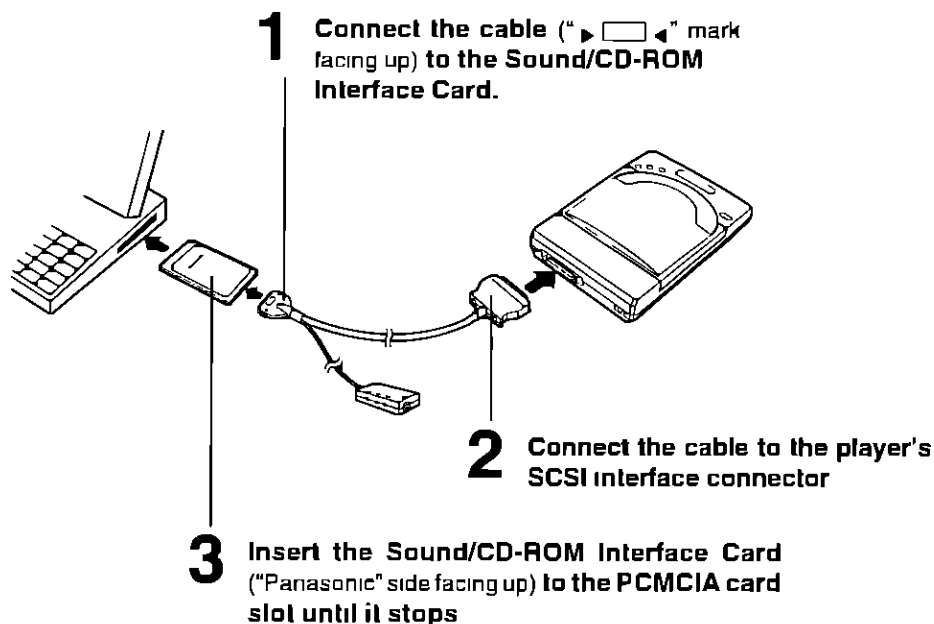

Note

- On some computers you might have to insert the card with the "Panasonic" side facing down. The card is keyed so it can only be installed in the correct direction.

■ Disconnecting Sound/CD-ROM Interface Card:

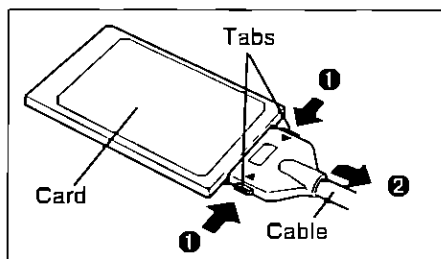

Pull the cable while pressing the side tabs of the cable

Caution

- Do not pull the cable by force, since this can damage the card

Connecting the speakers

Be sure that the power switch of the R-speaker is off and the volume control of the I/F Box is set to the lowest level. You can also connect your headphones to the PHONES jack of the I/F Box.

- 1 Install the supplied two "AA" size alkaline batteries into R-speaker. Make sure the polarities (+, -) match the diagram.

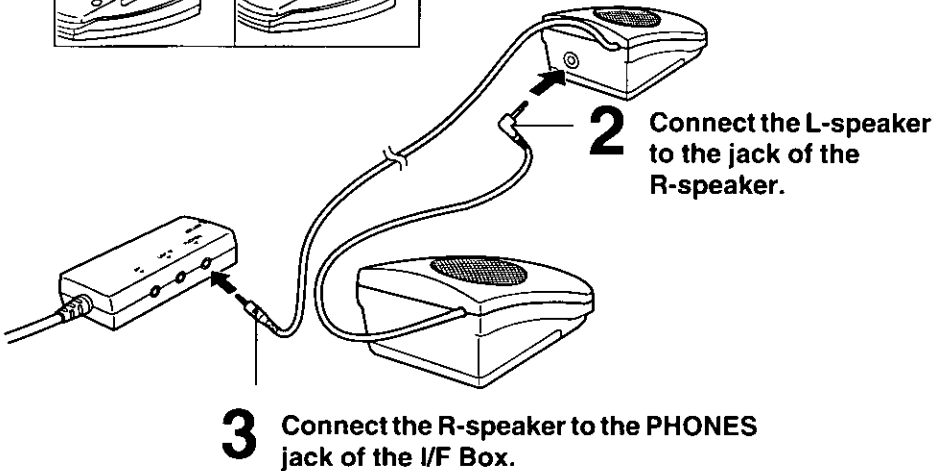
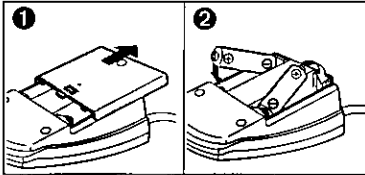

Connecting player to computer /
Connecting the speakers

Replacing the batteries

When the power indicator on R-speaker glows faintly and the playback sound becomes distorted or unstable, replace the batteries by following the instructions inside the R-speaker.

Please use alkaline batteries.

Battery Precautions:

If improperly used, the batteries may leak and cause corrosion. Therefore, observe the following.

- Install batteries according to the diagram.
- Do not mix old and new batteries, or carbon and alkaline battery types.
- Remove all batteries when not using the speaker for extended periods.
- Do not charge, short-circuit, disassemble, heat, or dispose of in fire.

Connecting the microphone

The supplied microphone can be used to make recordings of voices or other acoustical audio sources. For the detailed operation, refer to the enclosed Audio Applications Manual.

Caution

- Use only the supplied microphone, otherwise proper operation is not guaranteed.

Note

- Speakers may howl depending on the setting of the audio application (P 10, 20, 25 in Audio Applications Manual)

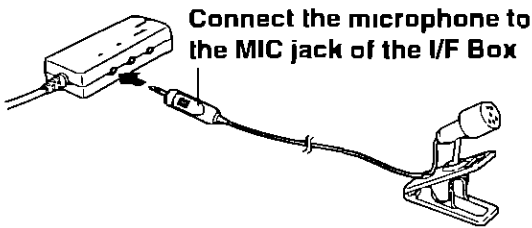

Connecting an audio connecting cable (not supplied)

When you wish to listen to (using the supplied speakers)/record an audio CD or the sound of CD-ROM which comes out of the player's PHONES jack, connect a commercially available audio connecting cable as illustrated in the diagram below. Other audio devices such as tape player can be substituted for the player.

Note.

- Whenever you connect/disconnect an audio connecting cable, be sure that the volume of the player and I/F Box are set to the lowest level.

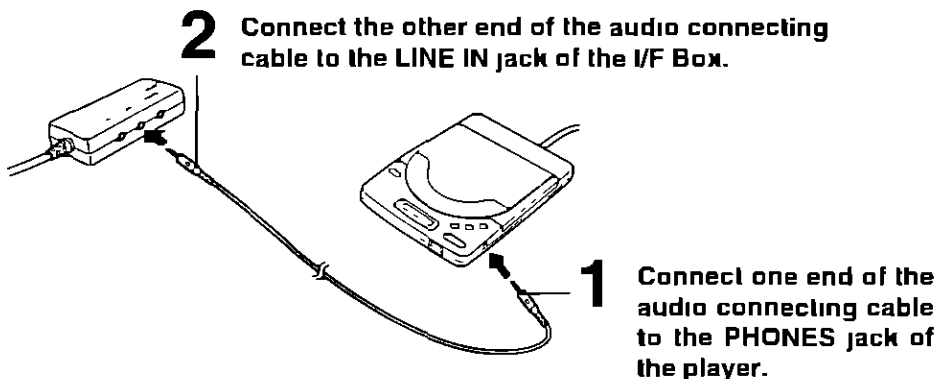

Power On

Player

Turn on the player by pressing the **POWER** switch and then turn on the computer. A blinking message "on" appears on the display of the player.

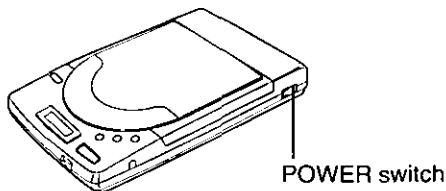

- When turning off the player, press the **POWER** switch again. The display message(s) will disappear.

Note:

- If the player is not going to be used for an extended period, unplug the AC adaptor from both the player and AC outlet to save the power consumption. (Approximately 3.0 W power is consumed when the player is OFF and the AC adaptor is connected.)



■ Power Save Function:

Your player enters the Sleep Mode under the following conditions to save power.

- When using the player with your computer, if no command is sent to the player from the computer for more than 4 minutes.
- When using the player independently, if no button of the player is pressed for more than 4 minutes.

During the Sleep Mode, the laser and spindle motor stop.

The player automatically re-starts when it receives a command from the computer or a button of the player is pressed.

Speakers

Turn on the speakers by switching the **POWER** switch on R-speaker to on (|) position.

Power indicator on R-speaker lights.

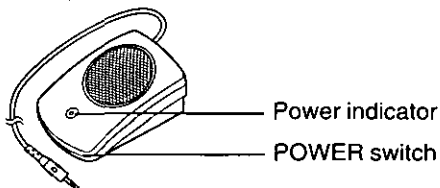

- When turning off the speaker, set the **POWER** switch on R-speaker to off (⊕) position.

Software Installation

Before installing software

The supplied Setup Disks contain the drivers for this product and the Audio Applications software

Note

- If you are currently in Windows, please exit Windows for proper software installation

System requirements

The Setup Disks can be used only in an IBM or compatible computer with a 3.5" floppy disk drive. System requirements are:

- IBM or IBM Compatible Computer
- 1 PCMCIA Type II Card Slot
- PCMCIA Controller i82365 compatible LSI or IBM Card Service (PCMCIA 1.07, 2.00) or SystemSoft (PCMCIA 2.01, 2.10) or Phoenix PCPLUS (PCMCIA 2.00, 2.01, 2.10) or CardTalk
- MS-DOS 5.0 to 6.2 or PC DOS 5.0 to 6.3
- Windows 3.1, 3.11 or Windows 95
- 33 MHz 80486 or Faster Micro Processor
- 4 MB of Available Hard Disk Space
- 8 MB RAM Recommended

Note

- This product is not compatible with the notebook computer which has a built-in sound system device

Making back-up copy

Before installing software, it is recommended that you make a back-up copy and store the original in a safe place.

Notes

- Use the DISKCOPY command of DOS to make a back-up copy. Refer to your DOS manual for further information.
- You may find it convenient to install the software directly onto your C drive (hard disk).

Installing under Windows 3.1, 3.11

Make sure that the necessary devices are connected (P. 12~14) and the player and the computer are turned on (P. 15).

- 1 Start Windows 3.1, 3.11.
- 2 Insert the supplied Setup Disk #1 into drive A (or B).
- 3 Select "Run..." from the File menu of the Program Manager.
- 4 Type A: (or B:) \SETUP and press **Enter** .
"Multimedia Sound Kit Install Program" window appears.
- 5 Click **Continue** .

The following window appears.

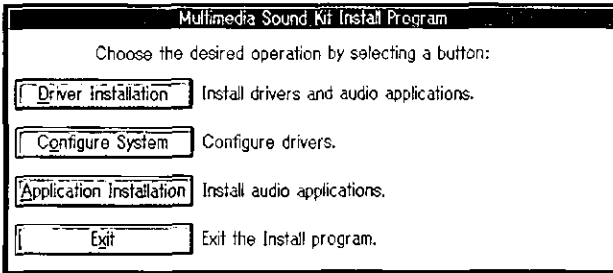

- If you want to install the drivers and Audio Applications software, go to next step.
- If you want to change the previous settings, select "Configure System" and follow the instructions on computer.
- If you want to install only Audio Applications software, select "Application Installation" and follow the instructions on computer.
- If you want to exit the install program, select "Exit" and follow the instructions on computer.



- 6 Click **Driver Installation** "Driver Installation" window appears

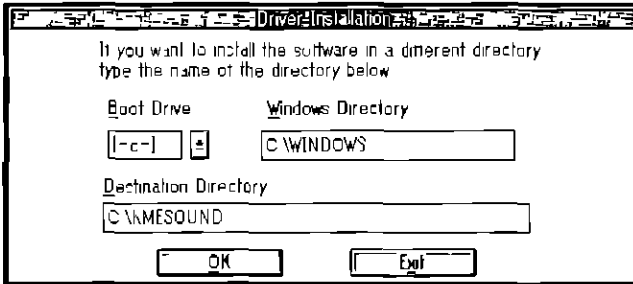

The default directory is KMESOUND. If you want to install the driver in a different directory, type the directory name and go to next step.

- 7 Click **OK** The following window appears

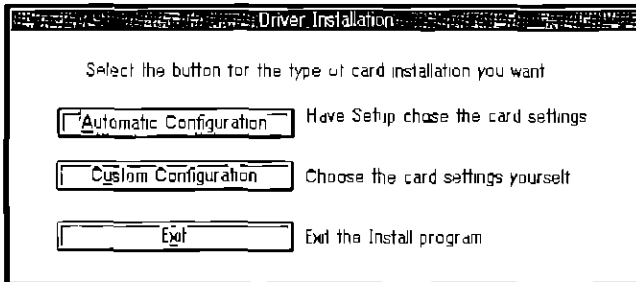

- Unless you need to configure the card settings yourself, select "Automatic Configuration" to install the hardware driver
- If you encounter problems after installing software, select "Custom Configuration" and change the settings
- If you want to exit the install program, select "Exit" and follow the instructions on computer

8 Click **Automatic Configuration**.

After copying files, the following message appears.

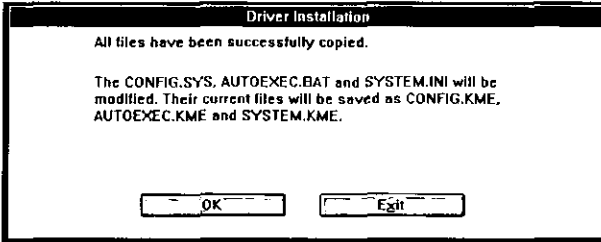

9 Click **OK**.

“Multimedia Sound Kit Install Program” window appears.

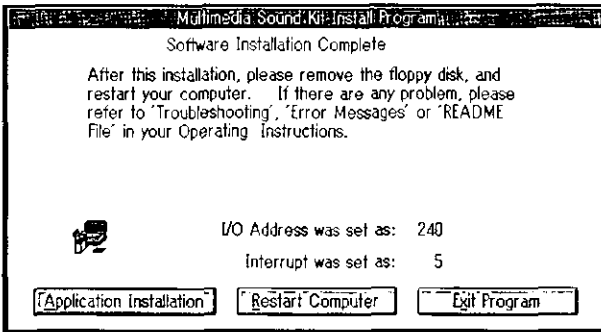

- If you want to install the Audio Applications software, go to next step.
- If you want to exit the install program, select “Exit Program”, exit the Windows, remove the Setup Disk #1 and then restart you computer.



10 Click **Application Installation** .

"Application Installation" window appears



The default directory is PCAUDIO. If you want to install the Audio Applications in a different directory, type the directory name, and go to next step.

11 Click **OK** . The following window appears

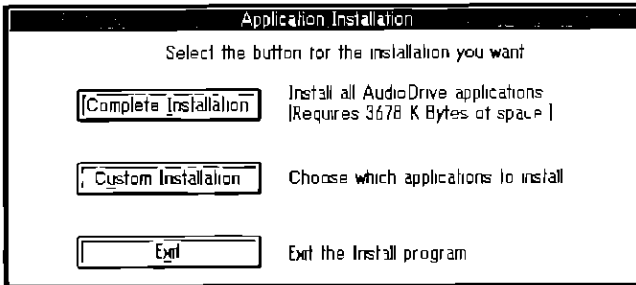

- If you want to install all Audio Applications software, go to next step
- If you want to select some Audio Applications, select "Custom Installation" and follow the instructions on computer
- If you want to exit the install program, select "Exit" and follow the instructions on computer

12 Click **Complete Installation**

While copying files, the following "Confirm" window appears

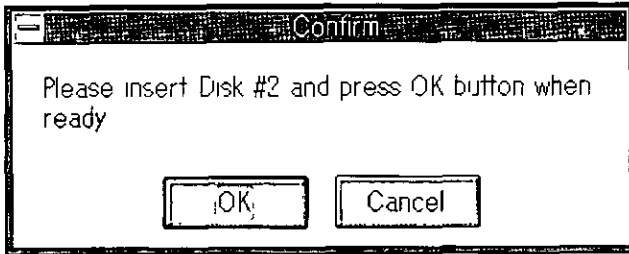

13 Remove the Setup Disk #1 and insert the Setup Disk #2, and then click **OK**

After copying files, "Multimedia Sound Kit Install Program" window appears

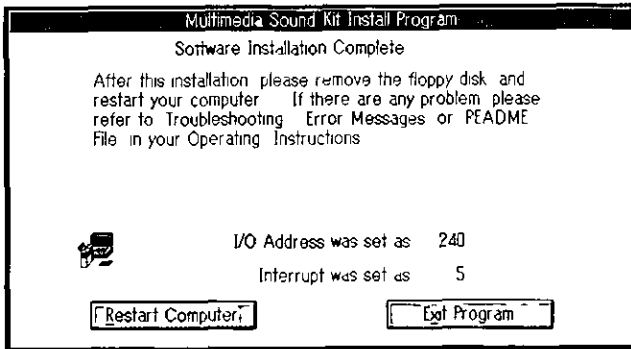

14 Click **Exit Program** and exit the Windows

15 Remove the Setup Disk #2 and then restart your computer.

Installing under Windows 95

Installing drivers

Three kinds of drivers need to be installed. To install these drivers, follow the instructions below.

1 Power on your computer.

Windows 95 automatically starts.

2 Power on the player (P. 15) and insert the Sound/CD-ROM Interface Card to your computer's PCMCIA card slot (P. 12, step 3).

"New Hardware Found" window appears only when the inserted card is not previously registered in Windows 95.

3 Click .

"Driver from disk provided by hardware manufacturer" is selected and "Install From Disk" window appears.

4 Insert the supplied Setup Disk #1 into drive A (or B), and click .

"New Hardware Found" window appears.

5 Click .

"Install From Disk" window appears.

6 Click .

"New Hardware Found" window appears.

7 Click .

"Install From Disk" window appears.

8 Click .

The initial screen appears and the drivers have been installed.

- If you want to install the Audio Applications software, perform the following steps ( P. 23).

Installing Audio Applications software

- 1** Double-click the My Computer icon
- 2** Double-click the 3½ Floppy icon
- 3** Double-click the Setup icon
“Application Installation” window appears
- 4** Click **Install**.
“Application Installation” window of step 10 (P 20) appears
- 5** Follow the steps 11 to 13 (P 20, 21)
- 6** Remove the Setup Disk #2 and then restart your computer.



Installing Windows 95 using the player

The Windows 95 operating system can be installed by inserting the Windows 95 CD-ROM into the player

1 Install the software by following the steps 1 to 15 (P 17-21).

2 Insert the Windows 95 CD-ROM into the player

3 Start Windows 3 1, 3 11.

4 Select "Run " from the File menu of the Program Manager

5 Type D \SETUP and press .

(D drive letter assigned to a CD-ROM drive for example)

Windows 95 installation will complete

However, the KXL-D721 DOS driver will currently be in use by Windows 95 This does not yield optimum performance therefore, the KXL-D721Windows 95 driver should be installed by performing the following steps (steps 6 to 9 below)

6 The following message appears when SETUP is completed

System Properties/Performance
ASPI5MGR in CONFIG SYS forces MS-DOS compatibility mode Compatibility
mode paging reduces overall system performance
PC Card (PCMCIA) devices are not using 32-bit support

Click to ignore this message Meanwhile, PCMCIA controller chip (iB2365) is unavailable on Windows 95

7 Double click the PC Card (PCMCIA) icon inside the Control Panel to enable PCIC (PCMCIA controller chip) on Windows 95.

8 When prompted by the PC Card Wizard, select and select . Then select again

9 Then restart your computer, in order to enable 32 bit- support, click .

To install the software under Windows 95, refer to "Installing under Windows 95"
(P 22)

If you need more information, please refer to SETUP TXT file or GENERAL TXT file of Windows 95 about installing Windows 95 CD-ROM

Inserting / Removing a CD

Inserting a CD

To insert your CD, follow the instructions below



1 Press  to open the disc cover.

3 Close the disc cover.

2 Place a CD onto the center spindle, and press on the inner most part of CD.

Note

- CD should be placed with the disc's label facing up

Removing a CD

After CD-ROM operation has finished, remove the CD by following the instructions below. Make sure that a blinking message "BUSY" does not appear on the player's display

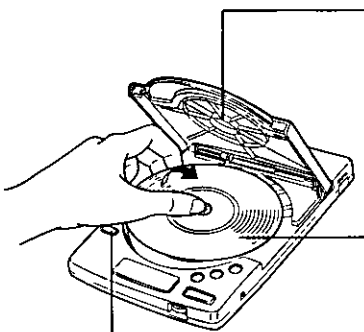

1 Press  to open the disc cover

3 Close the disc cover

2 Carefully remove the CD by pressing the center spindle and lifting

Note

- Replace the CD in its original case



CD-ROM / Audio CD Operation

After installing the software ( P 16), if you start your computer, you are ready to enjoy game/photo/audio CDs including the Audio Applications. For details about the Audio Applications operation, refer to the enclosed Audio Applications Manual.

Insertion/Removal with Power On (for DOS/Windows 3.1, 3.11)

If your computer has a Card Service, the Sound/CD-ROM Interface Card can be removed or inserted from/into the PCMCIA card slot of the computer without turning off your computer. However, when you start running your computer, make sure that the Sound/CD-ROM Interface Card is inserted into the PCMCIA card slot and the CD-ROM player is on. If ASPIS365 SYS and ASPISDBK SYS are being used, Insertion/Removal with power on is not possible.

Note

- If your computer has more than one slot, and if you want to re-insert the Sound/CD-ROM Interface Card, make sure to insert it into the same slot it was inserted before.

Plug & Play (for Windows 95)

Windows 95 supports Plug & Play function as the new feature.

This Sound/CD-ROM Interface Card supports this feature. You can plug/remove this card in/from your computer. When you turn on your computer, Windows recognizes and sets up your hardware automatically.

CD-ROM operation

Before operation make sure that the Sound/CD-ROM Interface Card and I/F Box are connected to your computer and to the player properly and all other necessary audio devices are connected ( P 12-14). The player should be ON when the computer is turned on.

Notes

- Some CD-ROMs are soundless.
- The computer sound of some CD-ROMs can be listened through the player's PHONES jack. Connect a commercially available audio connecting cable to the player's PHONES jack and to the I/F Box's PHONES jack ( P 14).

Audio CD Operation

Before operation make sure that the Sound/CD-ROM Interface Card and I/F Box are connected to your computer and to the player properly, and all other necessary audio devices are connected (P. 12-14). The player should be ON when the computer is turned on.

Listening to an audio CD

You can listen to your audio CD through either the attached speakers or your headphones (not supplied).

■ Using the Speakers:

After connecting the speakers (P. 13), connect a commercially available audio connecting cable to the player's PHONES jack and to the I/F Box's PHONES jack (P. 14).

■ Using your headphones:

Connect it to the player's PHONES jack as the diagram illustrated below.

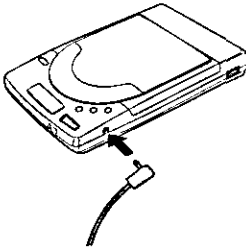

Note:





- Before playing an audio CD, make sure that the volume control of the player and/or I/F Box is set to lower level to avoid hearing very loud sound.



Playing an audio CD on computer

After inserting your audio CD into the player (P. 25), you can enjoy playing your audio CD on your computer. If you are using DOS, install **audio CD control software** (not supplied) to operate an audio CD on computer. Media player (included with Windows) can also be used to listen to audio CDs.

Note:

- While playing an audio CD on your computer, you can not use  ,  ,  and  buttons on player.

Playing an audio CD on player





If you are using batteries, you can enjoy listening to music under stable conditions. It is recommended not to play an audio CD while walking or jogging. If you want to play an audio CD without disconnecting from your computer, be sure to open and close the disc cover before playing to set the player into stand alone play mode.

Caution

- It is not safe to listen to headphones while driving a car.

Be sure the volume control is set to lower level to avoid hearing very loud sound and all necessary devices are connected (refer P 12-14)

You can play your audio CD by referring to the following table.

Button	Function
	Starts/pauses playing an audio CD
	Skips to the next track by pressing once
	Continues skipping tracks if you hold down
	Returns to the beginning of the track being played by pressing once
	Skips to the previous track by pressing once when the elapsed time is 00:00
	Continues reversing tracks if you hold down
	Stops playing an audio CD

Error Messages on Computer

When installing the software

The following messages appear only under Windows 3 1, 3 1 1

Message	Solution
The directory you typed is invalid Please type a full path with drive letter for example "C \KMESOUND"	Use less than eight characters
	Use only valid characters (refer to the DOS manual)
CONFIG SYS dose not exist in specified Drive	Specify the name of the drive containing CONFIG SYS in Boot Drive
Could not find the file [Filename] Please type the directory to look for this file	File indicated in [Filename] is not found Set the directory containing this file
Specified Window directory does not exist	Specify the correct directory-name in Windows Directory
PCMCIA Controller is not found Installation will be terminated	Make sure that your computer has PCMCIA slot
	Make sure that connection between your computer and card slot board has been made properly



README File

The README File on the supplied setup disk contains additional information on system troubleshooting and is copied to the hard disk (normally to C:\KMESOUND) during installation except Windows 95.

Read or print this file if you have difficulty installing the CD-ROM drive or sound function.

Viewing the README.TXT File in DOS

- 1** At the DOS prompt (C:\), type MORE <\KMESOUND\README.TXT
- 2** Press .

Viewing the README.TXT File in Windows 3.1, 3.11

- 1** Double-click the Notepad icon of Accessories.
- 2** Select "Open" from the File menu.
- 3** Double-click the copied directory name.
(Normally it is C:\KMESOUND)
- 4** Select the file name "README.TXT".
- 5** Click .

Viewing the README.TXT File in Windows 95

In case of Windows 95, README File is not copied to the hard disk. To view the file, follow the instructions below.

- 1** Double-click the My Computer icon.
- 2** Insert the supplied Setup Disk #1.
- 3** Double-click the 3½ Floppy icon.
- 4** Double-click the README icon.









Troubleshooting

Check the following points before returning the unit for service

Trouble	Possible Cause	Solution
Turn on the player's POWER switch, but nothing appears on the display	AC adaptor is not plugged into the outlet or DC IN jack correctly	Plug in the AC adaptor correctly (P 11)
	The batteries are not installed into player correctly, or dead	Install the batteries into player properly or replace with new ones (P 11)
The data of CD-ROM is not transmitted to your computer	Connection between the player and the computer is improper	Connect Sound/CD-ROM Interface Card and I/F Box to the player and to the computer properly (P 12)
	There are duplicate SCSI ID numbers in computer system	Set different SCSI ID number for each device in your system (P 33)
	The software is not installed correctly	Install the software correctly (P 16)
	The interface cable of pin is bent or broken	Contact an Authorized Panasonic Service Center
	Terminator of the player is set to OFF when using the player with the I/F Box attached	Set the terminator of the player to ON (P 33)
No sound can be listened or Power indicator on R-speaker does not light	The Speaker's POWER switch is turned off	Turn on the Speaker's POWER switch
	The batteries are not installed into R-speaker correctly, or dead	Install the batteries into R-speaker properly or replace with new ones (P 13)
	Headphones/Speakers are not connected	Connect the headphones to the player's PHONES jack firmly or connect the speaker to the I/F Box's PHONES jack (P 13, 27)
	Volume control of player or I/F Box are set to "0"	Set the volume control to a higher level
	L-speaker is not connected to R-speaker	Connect L-speaker to R-speaker properly (P 13)
	Volume is set to the lowest level or Mute is selected in the Volume Control/Mixer application	Set the volume to a higher level or turn off the Mute in the Volume Control/Mixer application (P 19, 20 in the Audio Applications Manual)



Troubleshooting

Trouble	Possible Cause	Solution
Transmission speed of data slows down	When using the batteries, the notebook computer has entered the power management mode	Set the CPU speed of the notebook computer faster in power management or use the AC adaptor
Buttons/POWER switch of player do not function		Press RESET switch located at the bottom by using a pointed object like a pen
"no DISC" message appears on player's display even after inserting a CD, Sound skips, or data can not be read	CD is placed with the label side facing down	Place the CD with the label side facing up ( P 25)
	CD without  or  mark is used	Use the CD marked with  or 
	CD may have become dirty	Clean the CD ( P 34)
	CD is damaged	Replace with another CD
	The player or/and CD are moistened, because the player or/and CD may be moved from a cold place to a warm place	Remove the CD from the player and leave it out for 1 hour
You can not record using Microphone	Microphone is not connected to the MIC jack properly	Connect the Microphone to the MIC jack properly ( P 14)
	Volume of Mic is set to the lowest level or Mute is selected in the Recording Control application	Set the volume of Mic to a higher level or turn off the Mute in the Recording Control application ( P 17 in the Audio Applications Manual)
Windows 95 computer does not recognize CD-ROM	The Sound/CD-ROM Interface Card is not fully inserted, or the player is not turned on	After turning on the player, open the My Computer, Control Panel, System and then Device Manager and click "Refresh"
Speakers howl	The volume of Mic is set too high, or the Record Monitor is on	Lower the volume of Mic, mute the Record Monitor in Recording Control application or lower the volume of I/F Box ( P 17 in the Audio Applications Manual)

SCSI ID Number and Terminator

■ SCSI ID number:

Each SCSI device connected to your computer system has an individual ID number (refer to the respective manuals). Be sure that the CD-ROM SCSI ID# does not conflict (is not the same) as another SCSI device connected to the computer system. Normally personal computer's SCSI ID number is set to 7.

The factory setting for the CD-ROM drive is SCSI ID #5.

■ Terminator:

Set the Terminator switch ON or OFF according to the player's condition.

ON: when the player is connected to the computer system.

OFF: when using independently as an audio player.

The factory setting is **ON**.

Setting

Turn the ID number switch (1-3) or Terminator switch (4) ON/OFF by using a pointed object like a pen, and referring to the table below (for ID number).

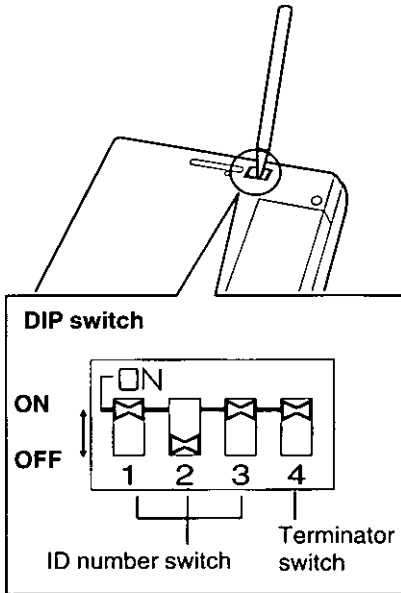

Example: ID number=5/Terminator=ON

(For SCSI ID number setting)

ID number	ID number switch		
	1	2	3
0	off	off	off
1	on	off	off
2	off	on	off
3	on	on	off
4	off	off	on
5	on	off	on
6	off	on	on
7	on	on	on

: Factory setting.



Maintenance

Player

Cautions

- Do not use benzene, thinner, etc
- Do not use commercial lens cleaner

Clean the outside of the player with a soft, dry cloth

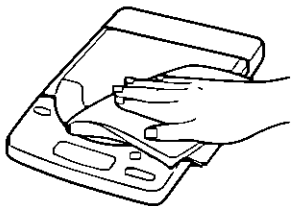

Clean the lens with a dry cotton swab or a lens blower

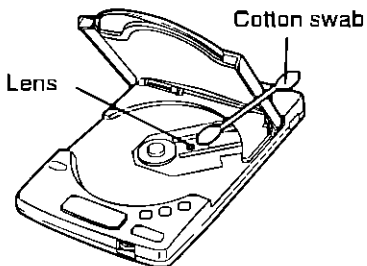

CD

Cautions

- Do not use solvents such as benzene, record cleaners or anti-static spray for records
- Do not touch the signal side
- Do not attach the labels to the disc
- Do not write on the surface of disc with a pointed object like a pen

Wipe from the center to the edge with a dry, soft cloth



Specifications

Operating Temperature	5°C {41°F} to 35°C {95°F}
Operating Humidity	20% to 85% RH
Storage Temperature	-20°C {-4°F} to 55°C {131°F}
Storage Humidity.	15% to 85% RH
Player.	
Dimensions	138 (W) × 204 (D) × 35 (H) mm {5 52" × 8 16" × 1 4"}
Mass {Weight}	0 39 kg {0 878 lb } (without batteries)
Power Source	Refer to the nameplate at the bottom of the unit
Interface	PCMCIA/SCSI I, II
Buffer Size	128 KB
Battery Life	Approximately 4 hours when playing audio CD at 20°C {68°F}
(when using Panasonic alkaline "AA" size)	Approximately 2 hours when playing CD-ROM at 20°C {68°F}
Power Consumption	<ul style="list-style-type: none"> •When playing CD-ROM <ul style="list-style-type: none"> 12 W [with AC adaptor] 4 2 W [with battery] •When playing audio CD <ul style="list-style-type: none"> 6 5 W [with AC adaptor] 2 8 W [with battery] •When player is off <ul style="list-style-type: none"> 3 0 W [with AC adaptor]
Data Transfer Rate	150 KB/s (Normal Velocity mode) 300 KB/s (Double Velocity mode)
Access Time	<ul style="list-style-type: none"> • With AC power source <ul style="list-style-type: none"> Access time*¹ (Double Velocity mode) 295 ms typical (1/3 stroke) Fullstroke access time*² (Double Velocity mode) 380 ms typical • With battery <ul style="list-style-type: none"> Access time*¹ (Double Velocity mode) 320 ms typical (1/3 stroke) Fullstroke access time*² (Double Velocity mode) 400 ms typical

*¹ Access time, Average data read over the complete area from 00' 02" 00 block to 1/3 stroke track

*² Fullstroke access time, Average data read over the complete area from 00' 02" 00 block to 59' 58" 74 block

The above information (*¹, *²) is based on the test results measured by Panasonic internal test software



Specifications

<p>Player: Output Connector: Compatible CD-ROM Format:</p> <p>Error Rates:</p> <p>Audio Performance (Stereo Headphones):</p>	<p>PHONES jack</p> <p>CD-DA (CD) CD-ROM (Mode 1 and Mode 2 Form 1) Photo CD Multi-session CD-ROM XA (Mode 2 Form 2)</p> <p>Soft read errors Less than 10^{-9} Hard read errors Less than 10^{-12}</p> <p>Frequency response 20 Hz–20 kHz S/N More than 80 dB (A Range) Output level 0.6 Vrms Audio CD Operation Play/Pause, Stop, Reverse skip, Forward skip Volume control Rotary (0–10)</p>
<p>Sound/CD-ROM Interface Card:</p> <p>Dimensions: Mass (weight): Card type: DTE interface: Power source:</p>	<p>54 (W) × 85.6 (D) × 5 (H) mm [2.13"×3.37"×0.20"] 0.04 kg (0.088 lb.) without cable Type II PCMCIA 2.1/JEIDA 4.2 DC5V, approximately 160 mA</p>
<p>I/F Box and cable:</p> <p>Dimensions: Mass (weight) Cable length:</p> <p>Mic (Monaural) Input level: Line in (stereo) Input level:</p> <p>Phones out (stereo) Output level: Frequency response: Volume control:</p>	<p>77 (W) × 45 (D) × 20.5 (H) mm [3.03"×1.77"×0.81"] 0.13 kg [0.286 lb.] with cable I/F Box side: 200 mm (not including connector) Player side: 500 mm (not including connector)</p> <p>200 mVrms or lower (impedance 2 k Ω or higher)</p> <p>1.2 mVrms or lower (impedance 30 k Ω or higher)</p> <p>15 mW or lower ±3 dB Volume Rotary (0–10)</p>

<p>Speakers:</p> <p>Dimensions for 2 units:</p> <p>R-speaker mass {weight}: cable length: impedance:</p> <p>L-speaker mass {weight}: cable length: impedance:</p> <p>Power Output: Battery power indicator: Battery type: Battery life:</p> <p>Battery power on/off:</p>	<p>68.2 (W) × 101 (D) × 45.8 (H) mm {2.69"×3.98"×1.80"}</p> <p>0.13 kg {0.286 lb.} (without batteries) 800 mm (without connector) 4 Ω</p> <p>0.1 kg {0.22 lb.} 800 mm (without connector) 4 Ω</p> <p>0.2 W+0.2W (stereo speaker amplifier) Red LED indication on R-speaker "AA" size alkaline battery × 2 into R-speaker Approximately 30 hours when using Panasonic "AA" size alkaline battery under the condition of 18 mW+18 mW output at 20°C (68 °F)</p> <p>In front of R-speaker only (Battery only supplies power to speaker amplifiers. Power for Sound/CD-ROM Interface Card and I/F Box is supplied from PCMCIA slot.)</p>
<p>Sound:</p> <p>Number of quantization bits: Sampling frequency: Sound source:</p> <p>Software compatibility:</p>	<p>8 bit, 16 bit monaural/stereo recording 5.5, 8, 11.025, 22.05, 44.1 kHz (Selectable) FM synthesis (YAMAHA OPL 3 compatible) PCM (CODEC) (Recording and playing method)</p> <ul style="list-style-type: none"> •WAVE (recording/playback) and MIDI (playback) performed using Windows-compatible audio device driver •Sound Blaster FM sound source for Windows and Ad-Lib for DOS compatible



Index

A

AC adaptor	6, 11
Accessories	6
Audio Applications	14, 16, 23, 26
Audio CD Operation	27
Audio connecting cable	14

B

Back-up copy	16
Battery	6, 11, 13
Battery cover	8, 10, 11, 13

C

Connection	12
Audio connecting cable	14
I/F Box	13, 14
Microphone	14
Speakers	13
CD-ROM Operation	26

D

DC IN jack	8, 11
DIP switch	8, 33
Disc cover	8, 25
Display	8
Display Messages	9

E

Error Messages on Computer	29
--------------------------------------	----

F

Features	6
Forward skip button	8, 28

I

I/F Box	6, 10, 13, 14
Insertion/Removal with Power On	26
Installing Windows 95 using the player	24

L

LINE IN jack	10, 14
L-speaker	10, 13

M

MIC jack	10, 14
Microphone	6, 14

O

OPEN button	8, 25
-----------------------	-------

P

Part Names and Functions	8
PHONES jack	8, 10, 13, 14, 27
PLAY/PAUSE button	8, 28
Plug & Play	26
Power On	15
Power Save Function	15
Power Supply	11
Precautions	7

R

R-speaker	10, 13
README File	30
RESET switch	8, 32
Reverse skip button	8, 28

S

SCSI ID number	8, 33
SCSI interface connector	8, 12
Setup Disk	6, 16, 17, 21, 22, 23
Software Installation	16
Sound/CD-ROM Interface Card	6, 12
Speakers	6, 10, 13
Specifications	35
STOP button	8, 28
System requirements	16

T

Terminator	33
Troubleshooting	31

V

VOLUME control	
I/F Box	10, 13, 27
Player	8, 27, 28

W

Windows 3.1, 3.11	17, 26, 30
Windows 95	22, 24, 26, 30



FOR USERS IN CONTINENTAL UNITED STATES ONLY

Technical Support and Service Parts Calls

If you have read this manual and tried the troubleshooting procedures, and you are still having difficulty, please contact the store from which the unit was purchased. Panasonic Communications & Systems Company will repair this product with new or refurbished parts free of charge for two (2) years from the date of purchase.

You may also call the technical support telephone number (24 hours/7 days).

The technical support number is: 1-800-PANA-SYS (1-800-726-2797)

The service parts number is: 1-800-332-5348

The serial number of this unit may be found on the label located at the bottom of the unit. Write this number below and keep this book along with your proof of purchase to serve as a permanent record of your purchase or for future reference.

MODEL NO. KXL-D721 NAME OF DEALER _____

SERIAL NO. _____ DATE OF PURCHASE _____

**Panasonic Communications & Systems Company,
Computer Products Division
Division of Matsushita Electric Corporation of America
Two Panasonic Way, Secaucus, New Jersey 07094**

**Panasonic Sales Company
Division of Matsushita Electric of Puerto Rico, Inc.
San Gabriel Industrial Park, 65th Infantry Avenue KM. 9.5
Carolina, Puerto Rico 00630**

**Matsushita Electric of Canada Limited
5770 Ambler Drive, Mississauga, Ontario, L4W 2T3**

**Matsushita Electric Industrial Co., Ltd.
Central P.O. Box 288, Osaka 530-91, Japan**
