

CONCORD 3043

3.1 MEGAPIXELS

User's Guide



CONGRATULATIONS

Congratulations on the purchase of your new camera. Your camera has been carefully engineered and manufactured to give you dependable operation. Read this manual before operating the camera to become more familiar with it.

This manual has been written and formatted with depth and detail so that you can easily follow the instructions to maximize the features of your camera.

Table of Contents

GETTING STARTED	4
Package Contents.....	4
System Requirements	5
Camera Overview.....	6
Loading the Batteries	9
Inserting an SD Card (Optional)	9
Turning the Camera On and Off	10
Setting the Date, Time and Date Stamp	10
TAKING PICTURES AND VIDEO CLIPS	11
Taking Pictures.....	11
Taking Pictures in Macro Mode.....	11
Taking Video Clips	12
Taking Continuous Pictures	12
Taking Pictures with Self-Timer.....	12
Using the Digital Zoom.....	13
Setting the Flash.....	13
Setting White Balance.....	14
Setting Exposure Compensation	14
Setting Size/Resolution.....	15
Customizing Your Camera Settings	15
REVIEWING YOUR FILES	18
Viewing Files.....	18
Magnifying Pictures.....	18
Thumbnail View.....	18
Running Slide Show.....	19
DELETING STORED FILES	20
Deleting One	20
Deleting All	20
Formatting the Internal Memory or SD Card	21
PRINTING STORED PICTURES	22
Selecting Pictures for Printing.....	22
Printing Pictures Directly.....	22

SOFTWARE INSTALLATION	23
Installing Your Camera Driver	24
Installing Direct X 9	26
Installing Arcsoft Software.....	27
Installing Adobe Acrobat Reader (optional)	30
DOWNLOADING PICTURES AND VIDEO CLIPS ONTO YOUR COMPUTER.....	33
Preparing to Download Files to Your Computer	33
Downloading Files to The Computer	33
USING ARCSOFT PHOTOIMPRESSION	34
USING ARCSOFT VIDEOIMPRESSION.....	35
USING CONCORD 3043 AS A WEB CAMERA.....	36
UNPLUGGING YOUR CAMERA FROM THE COMPUTER	39
CONNECTING THE CAMERA TO TV.....	40
Setting TV Mode	40
Connecting the Camera to the Television.....	40
Using the TV as a Live Viewfinder.....	40
Reviewing pictures and video clips on your TV	40
TROUBLESHOOTING.....	41
SPECIFICATIONS.....	43
GETTING HELP.....	44
SAFETY TIPS AND MAINTENANCE.....	45
REGULATORY INFORMATION.....	48

GETTING STARTED

PACKAGE CONTENTS

Check that all of the items shown below are included with your camera.

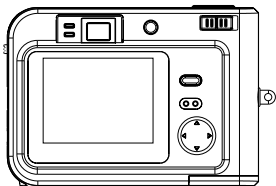

• Digital Camera

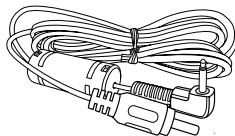

• TV Cable

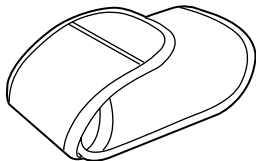

• Camera Case

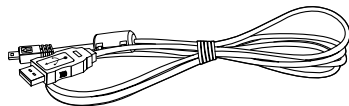

• USB Cable

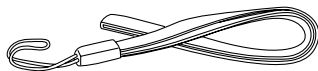

• Wrist Strap

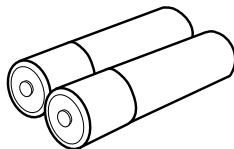

• 2X AAA Batteries

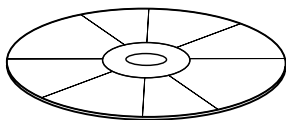

• CD-ROM(Includes Camera Driver,
Photo editing software, multi-lingual
User's Guide etc.)

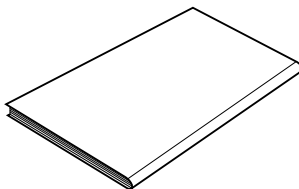

• Quick Start Guide

SYSTEM REQUIREMENTS

Windows:

- PC with processor better than MMX Pentium 300 MHz
- Windows XP/2000/ME/98SE
- Minimum 128 MB RAM
- USB port
- CD-ROM driver
- 1024 x 768 monitor, 24-bit color (true color)

Macintosh:

- Mac OS 10 or later

Specifications are subject to change without prior notice.

CAMERA OVERVIEW

Camera

The following illustrations show the names of each component, button and switch on the camera.

Front View

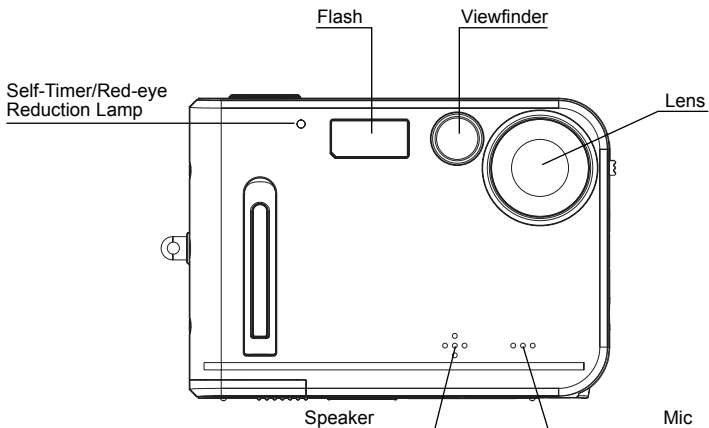

Back View

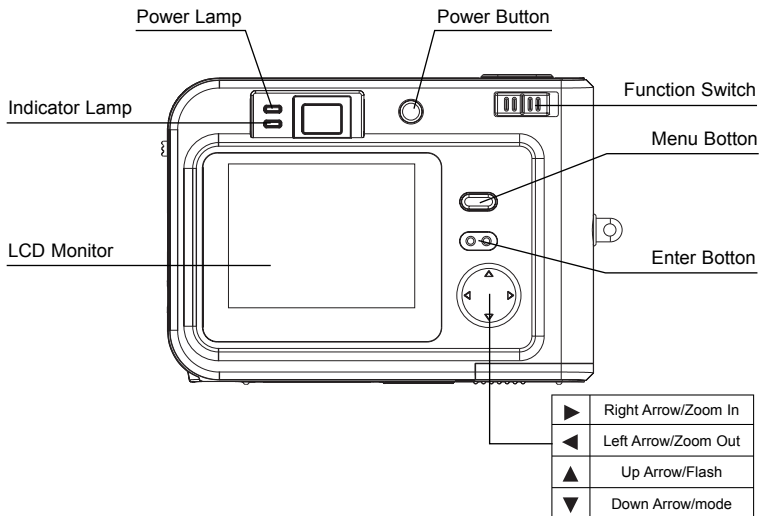

Top View

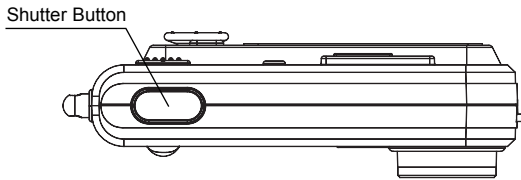

Bottom View

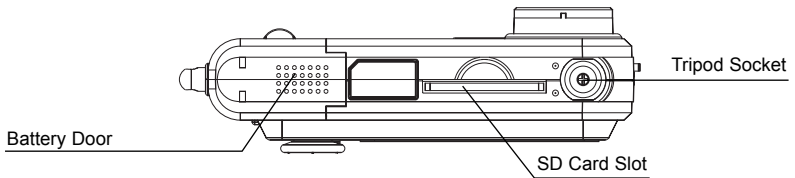

Side View

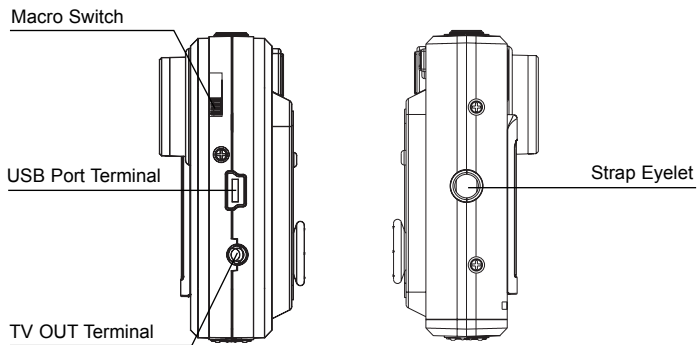

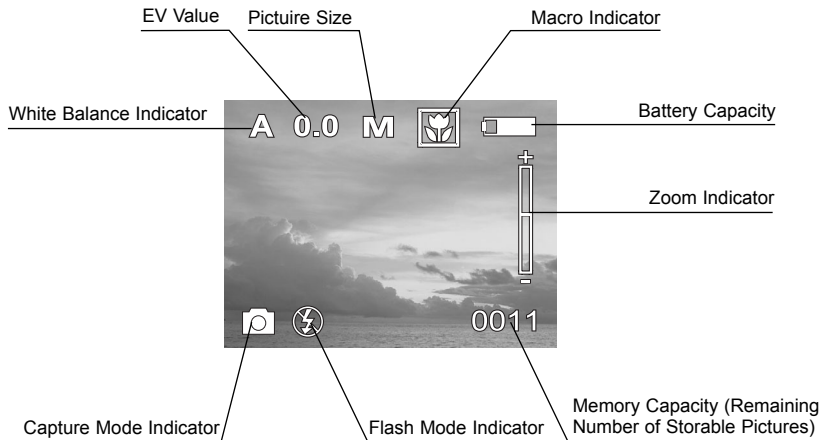
LCD indications**Shooting Mode****Review Mode**

LOADING THE BATTERIES

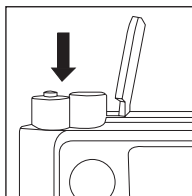

The camera uses 2x AAA alkaline or rechargeable batteries.

1. Slide the battery door and lift it open.
2. Insert the batteries according to the polarity indication engraved on the battery contact as shown.
3. Close the battery door.



Checking the Battery Level

The battery level indicates the power of the batteries.

Full (white)	Low (red, can not use flash)
	

When "Low Battery" is shown on the LCD, replace the batteries with the new ones.

Tips: If you will not use the camera for a long time, remove the batteries.

INSERTING AN SD CARD (OPTIONAL)

The camera is equipped with 16 MB of internal memory that can be used for storage as soon as you start taking pictures or recording video clips. Besides, the camera can use a Secure Digital (SD) memory card to store images and/or video clips. If no SD card is inserted in the camera, all pictures/video clips recorded by the camera will be stored in the internal memory. When SD card is inserted in the camera, all pictures and video clips recorded by the camera will be stored on the SD card.

To insert the SD card:

Insert the memory card in the direction as shown in figure, then gently but firmly push the SD card into the SD card slot as far as possible. When the card is fully engaged, a click can be heard.

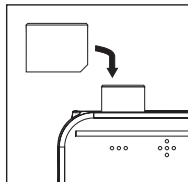

Note: NEVER forcefully push the card into the camera to avoid damaging both the card and/or the camera.

To remove the SD card:

Press the memory card into the slot then release. When the card is partially ejected, pull it out.

Note: If the “Memory Full!” warning message appears on the LCD, it means the SD card or internal memory is full. Please remove the memory card and insert a new one or transfer all images to your computer.

TURNING THE CAMERA ON AND OFF

Press the **Power** button to turn the camera on. The green Power lamp will light up, the LCD will turn on automatically.

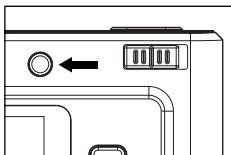

After one minute of inactivity, the LCD will automatically power off. Then the camera will automatically power off after being idled for around 3 minutes by default. To power off the camera sooner, press the **Power** button.

SETTING TIME AND DATE STAMP

When you first use your camera or when the batteries are removed for an extended time (approximately 120 minutes), you will need to set the Date and Time. The date and time information will be displayed on the picture if date stamp is turned on.



1. Slide the **Function** switch to  (Capture mode).
2. Press the **MENU** button.
3. Press the ◀ or ▶ button to select **Ad (Advance)**, and then press the **Enter** button to enter its sub-menu.
4. Press the ▲ or ▼ button to select **Date Time**, and then press the **Enter** button.
5. Press the ◀ or ▶ button to highlight the field to be changed, and then press the ▲ or ▼ button to set the value.
6. Press the ◀ or ▶ button to highlight **Date stamp**, then press the **Enter** button to turn the function on.
7. When the setting is completed, press the **MENU** button to return to capture mode.



TAKING PICTURES AND VIDEOS CLIPS



TAKING PICTURES

1. Power on the camera.
2. Slide the **Function** switch to  (Capture mode).

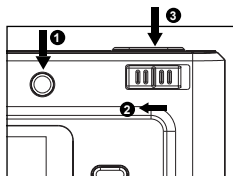
Note: In picture taking mode, the  icon will be shown on the lower left side of the LCD. If this icon is not shown, press the  button repeatedly until the  icon is shown.



3. Frame your subject with the LCD or viewfinder.
4. Hold the camera still and press the **Shutter** button to take the picture.

- The  and  icon will be shown briefly on the LCD after the **Shutter** button is pressed, which indicates that the camera is saving the picture. Do not power the camera off or remove the batteries before the picture is saved.



Note: If Quick View function is turned on(See '**Customizing Your Camera Settings**'), the LCD will show the image just taken and the options of:

Save: Press the **Enter** button to save the image.

Delete: Press the  button to select "delete" and then press the **Enter** button to delete the image. If no action is taken, the picture will be saved in 15 seconds or so.

TAKING PICTURES IN MARCO MODE

This mode enables the camera to take pictures in close distances.

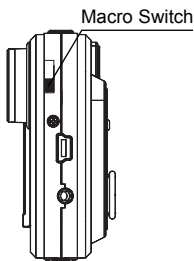

1. Slide the Macro Switch to  position. The Macro icon () will be displayed on the LCD.
2. Frame the subject in the LCD.
 - The best shooting range is between 40 cm to 50 cm (15.76 in. – 19.89 inches.)
3. Press the **Shutter** button to take the picture.



Important: When Macro shooting is not needed, remember to slide the Macro Switch back to Landscape () mode. Otherwise your pictures taken with shooting range go beyond 50 cm might be blurry.

TAKING VIDEO CLIPS

The camera can capture video clips with sound(Sound playback only on TV&PC).

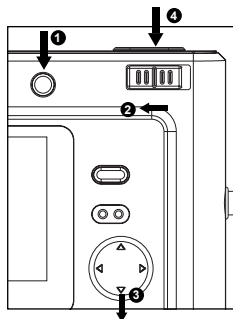

1. Turn on the camera.
2. Slide the **Function** switch to  (Capture mode).
3. Press the  button repeatedly until the Video Mode icon  appears on the LCD.
4. Use the viewfinder or LCD to frame your subject.
5. Press the **Shutter** button to start recording the video.
 - During recording, the recording time is displayed.
6. Press the **Shutter** button again to stop recording. Otherwise the camera will keep recording until the memory is full.



Note: The resolution for video clips can be set as VGA (640 x 480) or QVGA (320 x 240). To set the desired resolution, please see page 15.

TAKING CONTINUOUS PICTURES



The camera can capture 3 consecutive pictures in 1024x768 resolution when the Shutter button is pressed.

1. Slide the **Function** switch to  (Capture mode).
2. Press the  button until the Continuous Shooting icon () is shown on the LCD.
3. Press the **Shutter** button to take 3 continuous pictures in 1024x768 resolution.



To exit the Continuous Shooting mode, press the  button until the () icon disappears from the LCD.

TAKING PICTURES WITH SELF-TIMER

This function is useful for taking pictures where you want to be included in the photograph.

1. Slide the **Function** switch to  (Capture mode).
2. Press the  button until the Self-Timer icon () is shown on the LCD.
3. Press the **Shutter** button to activate the Self-Timer.



While the self-timer is functioning, the self-timer lamp on the front of the camera will blink. As the time to take the picture is closer, the lamp blinks faster, normally for 7 seconds, fast for the following 3 seconds, then the image will be captured.

To deactivate the Self-Timer. press  button until the Self-Timer icon () disappears from the LCD.

USING THE DIGITAL ZOOM

The camera provides up to 4x digital zoom.

In Video mode, when picture size is set to QVGA only 2x digital zoom can be achieved.

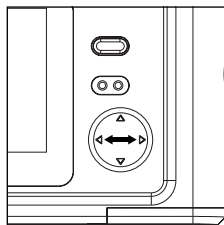

1. Press the  to zoom in. The digital zoom bar will be shown on the LCD.
2. Press the  to zoom out or return to the normal mode.



Important:





1. Hold your camera steady when using Digital Zoom to prevent blurred pictures, caused by jittery movement. It is recommended to either place your camera on a steady surface or mount it on a tripod.
2. The image quality may degrade slightly with Digital Zoom.

SETTING THE FLASH

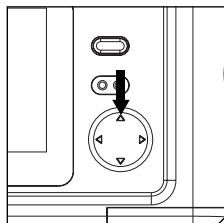
By default, the flash is set at **OFF** mode. When taking pictures at night, indoor, or outdoor in heavy shadows, you may press the  button to turn the flash on. Press the  button repeatedly until the desired indicator appears on the LCD.

- When pressing the  button for the first time, the LCD will be black for a while due to the flash being charged.
- When the flash is under charging, the orange lamp located next to the viewfinder will blink. When the flash is ready for taking pictures, the orange lamp will light steadily. Please wait until the flash stops blinking before proceeding to take pictures.









Flash Mode	Flash Fires
 Auto Flash	The camera judges if a flash is required. If the environment is too dark, the flash will fire.
 Fill Flash	Flash will fire in any lighting condition.
 Red-eye reduction	Use this mode to reduce the occurrence of "red-eyes" when taking pictures with a flash. The camera will automatically detect when the flash is needed and the flash will fire after a short delay.
 Off	In this mode, the flash will not fire, regardless of the lighting condition.

Note: Flash is not available in Video mode, Macro mode and Continuous Shooting mode.

SETTING WHITE BALANCE

When the white balance is set to match the light source, the camera can take picture more accurately.

1. Slide the **Function** switch to  (Capture mode).
2. Press the **MENU** button, the LCD will show **White Bal (White Balance)** in highlight.
3. Press the **Enter** button to enter its submenu.
4. Press the ◀ or ▶ button to select the desired white balance mode.
5. Press the **Enter** button to confirm.

	Auto (Default)	The camera sets the white balance automatically according to shooting conditions.
	Daylight	Use when shooting outdoors in sunlight on a clear day.
	Cloudy	Use when shooting outdoors and the sunlight is not enough such as under cloudy skies, in shade or at dusk.
	Tungsten	For shooting under tungsten lighting.
	Fluorescent	For shooting under fluorescent lighting.

SETTING EXPOSURE COMPENSATION

Exposure compensation lets you change the exposure setting EV value manually to suit the lighting condition of your subject. This feature helps to achieve better result when recording a backlit subject, a strongly lit subject indoors, or a subject that is against a dark background.



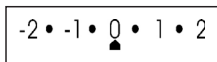

1. Slide the **Function** switch to  (Capture mode).
2. Press the **MENU** button.
3. Press the ◀ or ▶ button to highlight **EV (Exp Val)** and then press **Enter** to enter its submenu.
4. Press the ◀ or ▶ button to select desired exposure value.







(Note: The '•' mark represents '0.5')

5. Press the **Enter** button to confirm.

SETTING SIZE / RESOLUTION

1. Slide the **Function** switch to  (Capture mode).
2. press the **MENU** button.
3. Press the  or  to select **PS (Pict Size)** and then press the **Enter** button.
4. Press the  or  button to select the desired size/resolution.
5. Press the **Enter** button to confirm.







Size/Resolution options in different modes:

Mode	Indicator	Size	Description
 or 	L	2400 x 1800	Large picture size: produces higher picture resolution and larger file size.
	M	2048 x 1536	Standard picture size: produces normal picture resolution and moderate file size.
	S	1024 x 768	Small picture size: pictures are of lower resolution and file size is small.
	VGA	640 x 480	Standard Video resolution.
	QVGA	320 x 240	Best for e-mail.
	(none)	1024 x 768	Not selectable.

Note: The setting remains until you change it.

CUSTOMIZING YOUR CAMERA SETTINGS

Use **Advance** to customize your camera settings.

1. Slide the **Function** switch to  (Capture mode).
2. Press the **MENU** button.
3. Press the  or  button to select **Ad (Advance)** and then press the **Enter** button.
4. Press the  and  to highlight the item you want to adjust, and then press the  and  to highlight the desired setting.
5. Press the **Enter** button to confirm.
6. Press the **Menu** button to return to shooting status.

Setup menu and features**Beeper** ():

<input checked="" type="checkbox"/> <input type="checkbox"/> ON	When Beeper is set on, a beep sound can be heard when the camera is powered on .
<input checked="" type="checkbox"/> <input type="checkbox"/> OFF (Default)	No beep sound can be heard if Beeper is set at OFF mode.



Auto Power Off ():

<input checked="" type="checkbox"/> <input type="checkbox"/> ON	When Auto Power Off is activated, after one minute of inactivity, the LCD will automatically power off. Then the camera will automatically power off after being idled for around 3 minutes.
<input checked="" type="checkbox"/> <input type="checkbox"/> OFF (Default)	The camera will not power off automatically in this setting.



Quick Review ():

<input checked="" type="checkbox"/> <input type="checkbox"/> ON	When Quick View is set at ON mode, a preview of the picture/video just taken as well as the options of 'save' and 'delete' will be shown on the LCD. This is very convineint for deciding save the picture or not.
<input checked="" type="checkbox"/> <input type="checkbox"/> OFF (Default)	No preview of the picture/video just taken will be shown in this mode.

Self-Timer ():

 10 sec (Default)	Setting the timer for a 10 seconds' delay between the Shutter button is pressed and the moment when picture is actually taken.
 15 sec	Setting the timer for a 15 seconds' delay.
 20 sec	Setting the timer for a 20 seconds' delay.

Quality ():

 Super Fine	Setting the picture quality to super fine. (Lower compression, bigger file size)
 Fine (Default)	Setting the picture quality to fine.
 Normal	Setting the picture quality to normal. (Smaller file size)

TV ():

PAL	Setting the TV video signal format to PAL.
NTSC (Default)	Setting the TV video signal format to NTSC.

Language():

English (Default)	Setting the language to English.
Français	Setting the language to French.
Deutsch	Setting the language to German.
Español	Setting the language to Spanish.
Italiano	Setting the language to Italian.
Nederlands	Setting the language to Dutch.
Português	Setting the language to Portuguese.

Flicker(): While taking pictures or recording video clips under indoor florescent lighting, the flicker of the light source will decrease the image quality. To overcome this phenomenon, you can change the light frequency setting to suit the light source.

50Hz (Default)	Setting the flicker frequency to 50 Hz.
60Hz	Setting the flicker frequency to 60 Hz.

Date Time():

 YES	Setting the Date, Time, and Date Stamp. (p.10)
---	---

Reset():

 YES	Restore the settings of the camera to default setting.
---	--

Turning the LCD On or Off:









In Capture mode, the LCD can be turned on or off:

1. Press the **Enter** button to turn off the icons on the LCD.
2. Press the **Enter** button once more to turn the LCD off.
3. Press the **Enter** button a third time to turn the LCD back on.

Note: The LCD cannot be turned off in the Playback mode.













REVIEWING YOUR FILES

VIEWING FILES

- Slide the **Function** switch to  (Playback mode). The last picture or video clip will be shown on the LCD. The file type will be shown on the lower left corner of the LCD:
 = Picture,  = Video Clip
- Press the  button to skip to the previous file, press the  button to skip to the next file.
- To review video clips, press the **Enter** button.
 - While playing video clips, you may press the **Enter** button to pause or resume the playing.
 - When the whole video clip is played over, it will stop automatically. To stop playing the video clip sooner and skip to other file, press the  or  button.
- While reviewing pictures, you can press the  button to enlarge the picture and then press the  button to zoom out or return to the normal.

MAGNIFYING PICTURES



Use the Magnify feature to zoom in a specific area of the selected picture.

- Slide the **Function** switch to  (Playback mode).
- Press the  or  button to select the picture that you want to magnify.
- Press the **MENU** button.
- Press the  or  button to highlight **Zm (Zoom)** and then press the **Enter** button. A light blue frame will be shown on the LCD.
- Press the , ,  or  to locate the area to be magnified and then press the **Enter** button.
 - The selected area will be displayed at 2x magnification.
- Press , ,  or  to navigate to different parts of the picture.
- Press the **Enter** button to exit.



Note: Video clips cannot be enlarged.

THUMBNAIL VIEW

The camera provides index viewing, that is, to view six pictures at a time on the LCD so that you can search pictures quickly.

- Slide the **Function** switch to  (Playback mode).
- Press the **MENU** button.
- Press the  or  button to highlight **Vw (View)** and then press the **Enter** button. The LCD



shows options as below:

	Single	To display one picture each time.
	Thumbnails	To display up to six files on the LCD at a time.
	Slide Show	To play a slide show of all the stored files one by one.

- Press the ◀ or ▶ button to select  (**Thumbnail**) and then press the **Enter** button.
 - Up to six thumbnail view files appears on the LCD. For video clips, only the first frame can be seen.
- Press the ▲ or ▼ button to select specific picture/video that is shown in the current screen.
 - The selected picture or video clip is highlighted in blue.
 - If total number of the stored picture/video clips exceeds six, you may press the ◀ or ▶ button to display the thumbnail files in the previous or next screen.
- Press the **Enter** button to display selected picture or video clip in full screen.

RUNNING SLIDE SHOW

Start the Slide Show features to sequentially display the images on the camera LCD monitor, on a television screen, or on any external display devices equipped with a video input port.

- Slide the **Function** switch to  (Playback mode).
- Press the **MENU** button.
- Press the ◀ or ▶ button to highlight **Vw (View)** and then press the **Enter** button.
- Press the ◀ or ▶ button to select  (**Slide Show**) and then press the **Enter** button.
 - The slide show will start at once from the first picture or video clips on. Each file will be displayed once.





Note: Only the first frame of the video clips will be displayed.



- The slide show will stop automatically when the last file is shown. To stop the slide show sooner, press the **Enter** button.

DELETING STORED FILES

Note: Once file is deleted, it cannot be recovered.







DELETING ONE FILE

1. Slide the **Function** switch to  (Playback mode).
2. Press the  or  button to select the picture or video you want to delete, and then press the **MENU** button.
3. Press the  or  button to highlight **Del (Delete)** and then press the **Enter** button. The LCD shows options as below:

	Delete One	To delete the current picture or video.
	Delete All	To delete all pictures and videos.
	Format	To format the internal memory or SD card.







4. Press the  or  button to select  [**Delete One**], and then press the **Enter** button.
 - The selected file will be deleted.

DELETING ALL FILES

1. Slide the **Function** switch to  (Playback mode).
2. Press the **MENU** button.
3. Press the  or  button to highlight **Del (Delete)** and then press the **Enter** button.
4. Press the  or  button to select  (**Delete All**), and then press the **Enter** button.
 - All stored pictures and video clips will be deleted. The LCD will show "NO PICTURE!" when all files are deleted.

FORMATTING THE INTERNAL MEMORY OR SD CARD**Caution:**

1. Formatting will delete all pictures and video clips from the memory.
2. During the formatting process, never remove the memory card or batteries, as it will damage the card and/or the camera.
3. When a memory card is not inserted into the camera, selecting the formatting function will format the internal memory instead. All pictures and video clips stored in the internal memory will be deleted.





1. Slide the **Function** switch to  (Playback mode).
2. Press the **MENU** button.
3. Press the  or  button to highlight **Del (Delete)** and then press the **Enter** button.
4. Press the  or  button to select  (**[Format]**), and then press the **Enter** button.
 - The internal memory or SD card will be formatted in a few seconds. The **"NO PICTURE!"** message will then appear on the LCD.



PRINTING STORED PICTURES

SELECTING PICTURES FOR PRINTING



You can select pictures for direct printing by a photo developing service center or on a direct print compatible printer.

1. Insert the SD card.
2. Slide the **Function** switch to  (Playback mode).
3. Press the **▲** or **▼** button to select the picture you want to print.
4. Press the **MENU** button.
5. Press the **◀** or **▶** button to highlight **Pr (Print)** and then press the **Enter** button. The LCD shows options as below:



	Print One	To print the current picture.
	Print All	To print all pictures.
	Cancel One	To cancel the print setting for the current picture.
	Cancel All	To cancel the print setting for all pictures.

6. Press the **◀** or **▶** button to highlight  (**Print One**) and then press the **Enter** button.
 - The icon  will appear on the bottom left corner of the LCD, which indicates the picture is selected for direct printing.

To print all the pictures on the SD card:

1. Repeat step 1-5 above. (**Note:** Step 3 can be bypassed.)
2. Press the **◀** or **▶** button to highlight  (**Print All**) and then press the **Enter** button.
 - All the pictures stored on the SD card will have an  icon.

To cancel direct printing settings:

1. Repeat step 1-5 above.
2. Press the **◀** or **▶** button to highlight  (**Cancel One**) or  (**Cancel All**) and then press the **Enter** button.
 - The  icon will disappear, which means the direct printing setting is deleted.

Note: The direct printing supports SD card only.

PRINTING PICTURES DIRECTLY

1. Select the desired pictures (see 'Selecting Pictures for Printing' section).
2. Take the SD card out of the camera.
3. Insert the SD card into the SD card slot of a direct printing compatible printer.
4. Refer to the instruction manual of the printer to print the pictures.

SOFTWARE INSTALLATION (FOR WINDOWS USERS)

Option	Description
Camera Drivers	Enable the camera to become an external drive on your computer under Windows 98SE, and enables the PC-Cam function under any of required Windows systems.
Microsoft DirectX 9	DirectX 9 enables the movie playback applications on your computer to playback video clips that are captured with the camera.
Arcsoft Software	This photo software enables you to edit and enhance pictures.
Adobe Acrobat Reader	Enables you to view the electronic version of the User's Guide.
User's Guide	Direct link to the electronic version of the User's Guide in different languages. (All User's Guides are saved in PDF format.)
Concord Support Website	Direct link to our camera support website. Ensure that an internet connection is established before clicking on the link.

USING THE INSTALLER SPLASH SCREEN



The installer will automatically detect which software applications need to be installed or if they are not necessary. This will be indicated by the buttons on the splash screen that appears when the CD-ROM is inserted into the computer:

Color	Description
Yellow (●)	Required or highly recommended to install.
Gray (●)	Already installed or not necessary to install.





INSTALLING YOUR CAMERA DRIVER

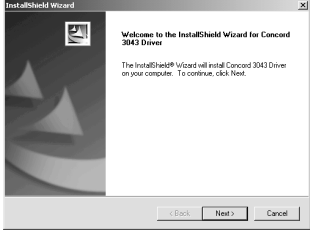
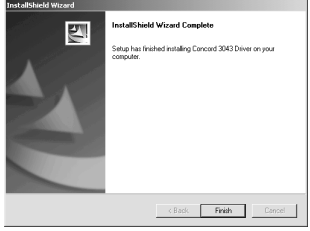
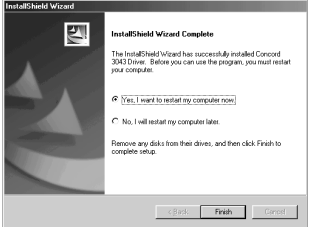

Note: To avoid compatibility issues, we recommend users of Win98SE and Windows ME to upgrade their OS through microsoft's website before installing the camera driver.

Step 1	Make sure that your camera is not connected to the computer.
Step 2	Make sure the computer is powered on and Windows 98SE/ME/2000/XP is running.
Step 3	Close any other applications or software you may be running.
Step 4	<p>Insert the supplied CD-ROM into the CD-ROM drive. The installer will pop up automatically.</p> <p>Note: If the installer does not appear automatically, double click 'My Computer', and then double click the CD-ROM drive.</p>
Step 5	<p>Select the language. Click [OK].</p> 
Step 6	<p>The installation screen will appear. Click on Install Camera Drivers.</p> 
Step 7	<p>Select the language. Click [OK].</p> 

Step 8	Click [Next] .	
Step 9	Click [Finish] .	
Step 10	To ensure the complete installation and enable the camera to function well, please do select “ restart your computer ”.	

INSTALLING DIRECTX 9

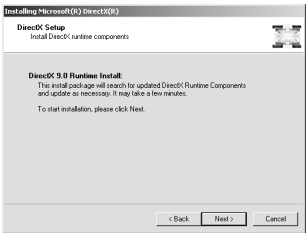
Step 1	Make sure your camera is powered off and not connected to the computer.
Step 2	Make sure the computer is powered on and Windows 2000 is running.
Step 3	Close any other applications or software you may be running.
Step 4	<p>Insert the supplied CD-ROM into your computer's CD-ROM Drive.</p> <p>NOTE: If the installer does not start automatically within 30 seconds after the CD-ROM has been inserted, click on "My Computer" either on the Desktop or in the Start Menu and locate the CD-ROM Drive. Double click on the CD-ROM Drive icon for installation and proceed to Step 5.</p>
Step 5	<p>Select the language. Click [OK].</p> 
Step 6	<p>The installation screen will appear, click on Install Microsoft DirectX 9.0.</p> 
Step 7	<p>The next screen will begin the DirectX setup. Select "I accept the agreement " then click [Next >].</p> 

<p>Step 8</p>	<p>Click [Next >].</p>	
<p>Step 9</p>	<p>Click [Finish]. Your computer will automatically restart.</p>	

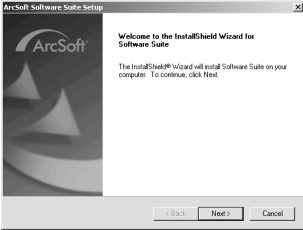
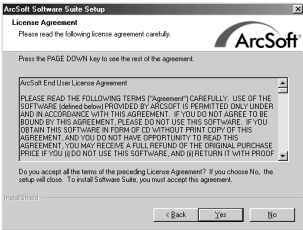
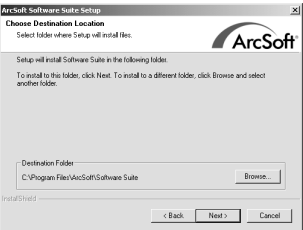

INSTALLING ARCSOFT SOFTWARE

<p>Step 1</p>	<p>Make sure your camera is powered off and not connected to the computer.</p>
<p>Step 2</p>	<p>Make sure the computer is powered on and Windows is running.</p>
<p>Step 3</p>	<p>Close any other applications or software you may be running.</p>
<p>Step 4</p>	<p>Insert the supplied CD-ROM into your computer's CD-ROM Drive. NOTE: If the installer does not start automatically within 30 seconds after the CD-ROM has been inserted, click on "My Computer" either on the Desktop or in the Start Menu and locate the CD-ROM Drive. Double click on the CD-ROM Drive icon for installation and proceed to Step 5.</p>
<p>Step 5</p>	<p>Select the language. Click [OK].</p> 

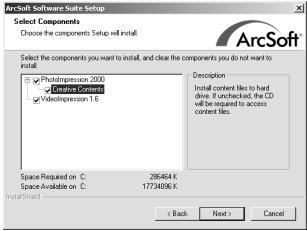
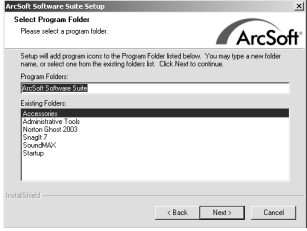
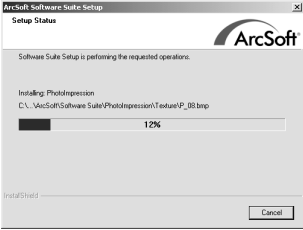
<p>Step 6</p>	<p>The installation screen will appear, Click on Install ArcSoft Software.</p>	
<p>Step 7</p>	<p>Click [Next >].</p>	
<p>Step 8</p>	<p>Click [Yes].</p>	
<p>Step 9</p>	<p>Click [Next >].</p>	

<p>Step 10</p>	<p>Make sure the two applications are checked and then click [Next >].</p> 
<p>Step 11</p>	<p>Click [Next].</p> 
<p>Step 12</p>	<p>The screen will show the status of the installation.</p> 
<p>Step 13</p>	<p>Click [Finish]. Win98SE will request for restart.</p> <div style="display: flex; justify-content: space-around;"> <div data-bbox="228 1061 508 1273"> <p>Win 98SE</p> </div> <div data-bbox="638 1061 919 1273"> <p>Win2000/ME/XP</p> </div> </div>

INSATLLING ADOBE ACROBAT READER (OPTIONAL)

Step 1	Make sure your camera is powered off and not connected to the computer.
Step 2	Make sure the computer is powered on and Windows is running.
Step 3	Close any other applications or software you may be running.
Step 4	<p>Insert the supplied CD-ROM into your computer's CD-ROM drive.</p> <p>NOTE: If the installer does not start automatically within 30 seconds after the CD-ROM has been inserted, click on My Computer either on the Desktop or in the Start Menu and locate the CD-ROM Drive. Double click on the CD-ROM Drive icon for installation and proceed to Step 5.</p>
Step 5	<p>Select the language. Click [OK].</p> 
Step 6	<p>The installation screen will appear, Click on Install Adobe Acrobat Reader 6.</p> 

"Recomposing data ..." status bar appear.

Note for Win 98 SE users: As Adobe Reader 6 requires Internet Explorer 5.01 or greater, you may see below information:



Note for Win 2000 users: As Adobe Reader 6 need the support of Win 2000 SP2, you may see below information:



Step 7



In this case, please click **[OK]** to close the message screen, and then click **[Finish]** to terminate the Adobe Reader 6 installation. Then go to www.microsoft.com website to upgrade your system and then to install the Adobe Reader 6 again.

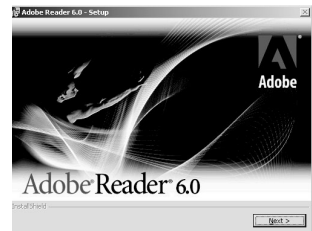

Step 8

If your Internet Explorer is version 5.01 or above, the installation of Adobe Reader 6 will start. The screen shows screen as below. Click **[Next >]**.

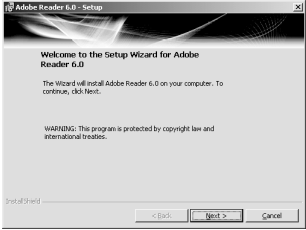
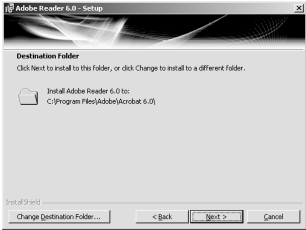
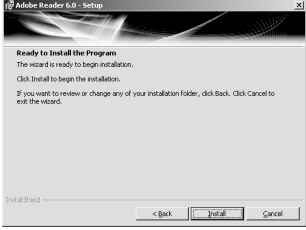

<p>Step 9</p>	<p>Click [Next >].</p>	
<p>Step 10</p>	<p>Click [Next >]. The files will be saved into C:\Program Files\Adobe\Acrobat 6.0 automatically. You may change the default folder by clicking [Change Destination Folder...] and selecting a different folder in your computer.</p>	
<p>Step 11</p>	<p>Click [Install] to start install the Adobe Reader 6.</p>	
<p>Step 12</p>	<p>Click [Finish].</p>	

DOWNLOADING PICTURES AND VIDEO CLIPS ONTO YOUR COMPUTER

PREPARING TO DOWNLOAD FILES TO YOUR COMPUTER

Note: For Win 98SE, you must install the driver before downloading files.

1. Slide the **Function** switch to  (Playback mode).
2. Turn on the camera.
3. Connect the camera to the computer with the Mini-USB cable included with the camera by plugging the larger end of the Mini-USB cable into your PC's USB port first and then plug the small end of the Mini-USB cable into the USB port of the camera.

Downloading files from the camera:

- Internal memory: Do not insert the memory card.
- Memory Card: Insert the memory card.

DOWNLOADING FILES TO THE COMPUTER

FOR WINDOWS USERS

1. Double-click on My Computer.
2. Double-click **Removable Disk**.
3. Double-click **DCIM**.
4. Double-click the folder that contains the desired images to view.
 - The stored pictures (JPG) and video clips (AVI) stored in the memory will be displayed.
5. Click and drag the files into a directory in your computer to save them.
 - To select all files, click **Edit > Select all**.

FOR MACINTOSH USERS

1. Connect the camera to the computer.
 - After a few moments, the external hard drive will appear on the desktop.
2. Double-click the "**Removable Disk**" removable drive that is on your desktop.
3. Double-click **DCIM**.
4. Double-click the folder that contains the desired images to view.
 - The stored pictures (JPG) and video clips (AVI) stored in the memory will be displayed.
5. Drag and drop the image you want to save in the computer.
 - To select all files, click **Edit > Select all**.

Note: You may also transfer the stored pictures and video clips on your memory card onto your computer by using a memory card reader (sold separately.)

USING ARCSOFT PHOTOIMPRESSION (WINDOWS ONLY)

1. Connect the camera to the computer.
2. Launch ArcSoft PhotoImpression software by clicking on Start-Programs-ArcSoft Camera Suite and choosing **PhotoImpression** from the application list on your screen. (fig. 1.1)



(fig. 1.1)



(fig. 1.2)

3. When the Application opens, click on the **Camera/Scanner** button.(fig. 1.2)
4. Click on the drop-down list under Select Source and choose **Concord Camera**.
5. Click on the **Camera/ Scanner** Icon ().
 - A second window will appear showing the contents (pictures) in the memory, and options on how to handle them. (fig. 1.3)

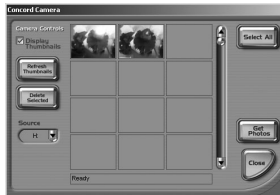

(fig. 1.3)

6. Select the picture you would like to view, edit or save by clicking on it. The selected image will be highlighted by a border. You may also click on **Select All** to choose all pictures.
7. Click on **Get Photos**.
The pictures will then be added to your album at the bottom of the application (fig. 1.4).



(fig. 1.4)

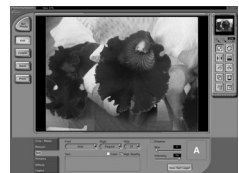



8. Click on Close to close the Camera Controls windows (as shown in fig. 1.3).
9. Double-click on the thumbnail or click on **OK** to open the photo.

10. Click on **Edit** to edit the photo. You may, for example,
- Resize the photo by using the “**Crop/Resize**” tools.
 - Modify the photo by using the “**Retouch**” tools. For example, to remove red-eyes.
 - Add some text onto the photo by using the “**Text**” tools.
11. Click on **Save** to save the photo. Two options “**Save**” and “**Save As**” will be offered.
12. Click on **Print** to print the photo. You can choose one preferred way of printing: Standard Printing, Greeting Card/Multiple Printing or Thumbnail Printing.

USING ARCSOFT VIDEOIMPRESSION (WEB MODE)

You can record live video clips on your computer by using the ArcSoft VideoImpression software.

Note: You cannot download video clips that are stored in the camera by using this application.

<p>Step1</p>	<p>Make sure that your camera is securely connected to your PC.</p> <p>Note:</p> <ol style="list-style-type: none"> 1. Do not connect the camera to the computer before camera drivers and DirectX 9 installation is completed. 2. Set the Mode to the  position.
<p>Step2</p>	<p>Launch the ArcSoft VideoImpression software by clicking on Start-Programs-ArcSoft Camera Suite and choose VideoImpression from the application list on your screen. The screen shows when the application opens.</p> 
<p>Step3</p>	<p>Click on the NEW icon.</p>
<p>Step4</p>	<p>Click on the CAPTURE icon.</p> <p>Note: If the video is not displayed, select “CONCORD 3043” in the Driver List and click on the Live icon to view live video.</p>
<p>Step5</p>	<p>Click on the RECORD icon. To stop recording, press the ESC button on your keyboard or click PAUSE icon on your screen.</p> <p>To save your video, simply click on the SAVE icon and follow the onscreen instructions.</p>

USING CONCORD 3043 AS A WEB CAMERA (FOR WINDOWS ONLY)

Note : You must install the camera's driver and DirectX 9 before using the web camera.

- Slide the **Function** switch to  (Capture mode).
- Make sure that the camera is securely connected to your computer .
- Turn on your camera.
 - The computer will automatically find your camera and install it for the first time connecting the camera to your computer, the installation message will vary on the different Windows Operating Systems(See the “**INSTALLATION MESSAGE**”).
- Launch Microsoft NetMeeting software.

Note: For Win ME/2000, click on “**Start>Program>Accessories>Communication>NetMeeting**” to launch NetMeeting software.

For Win 98SE/XP, click “**Start>Run**”, type “conf” to launch NetMeeting software.

Or

If you do not have NetMeeting already installed on your computer, please visit www.microsoft.com for instructions on how to download it onto your computer.

INSTALLATION MESSAGE

For Win 98SE

- The following message will pop up, indicating that the Windows system recognizes a new device and is searching for the driver.
- The following message will pop up to ask for insertion of Windows 98SE CD-ROM. Insert the Windows 98SE CD-ROM into the CD-ROM drive, then click “**OK**”.
- Click “**Browse**” to find the driver.

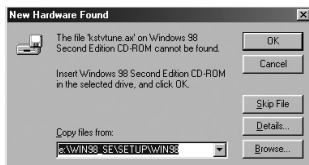

4. Make sure the drive option is CD-ROM drive, then locate and double click Win98 folder, then click **"OK"** .



5. Click **"OK"** to continue and complete the installation.

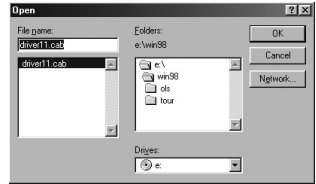

For Win 2000

1. The warning message of **"Digital Signature Not Found"** will pop up. Click **"Yes"** to continue to complete the installation.



2. The installation message will pop up. Click **"Finish"**.

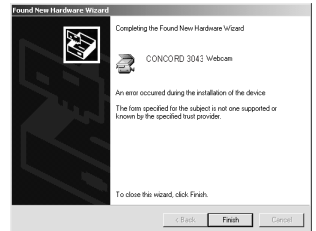

For Win XP

1. The installation message will pop up. Click **"Next"**.

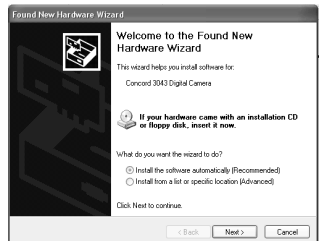

- The “Hardware Installation” warning will appear, click “Continue Anyway” to proceed.
Note: The message of “Hardware Installation” will occur 2 times successively, just click “Continue Anyway” to proceed.



- Click “Finish” to complete the installation.



UNPLUGGING YOUR CAMERA FROM THE COMPUTER

Windows 98SE:

Unplug the Mini-USB from the camera directly.

Windows ME/2000/XP:

1. Turn the camera off.
2. Click once on the “Unplug or Eject Hardware” icon on the right hand side of your task bar. (fig. 1.1)
3. Select “Stop Concord camera USB Mass Storage Device”
4. Click **[OK]** in the “Safe to Remove Hardware” prompt.
5. Unplug the Mini-USB from the camera. (fig. 1.2)

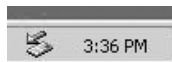

fig.1.1

Macintosh:

1. Drag the “**Removable Disk**” removable drive icon on the desktop to the Trash.
2. Unplug the Mini-USB cable from the camera.

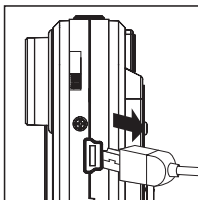



fig.1.2

CONNECTING THE CAMERA TO TV

SETTING TV MODE

The camera allows you to view individual files and to take pictures or record clips on the television. To begin, check your television documentation to determine the suitable type of TV broadcast standard:

NTSC or **PAL**.

1. Slide the **Function** switch to  (Capture mode).
2. Press the **MENU** button.
3. Press the ◀ or ▶ button to select **Ad (Advance)** and then press the **Enter** button.
4. Press the ▲ and ▼ button to highlight **TV** and then press the ◀ and ▶ to select **NTSC** or **PAL**.

Note: The selection of NTSC or PAL is according to video system used in the country where you are.

5. Press the **Enter** button to confirm.
6. Press the **Menu** button to exit.

CONNECTING THE CAMERA TO THE TELEVISION

1. Plugging the one end of the supplied Video Cable to the **VIDEO** or **VIDEO IN** jack on your television, then connect the other end of the Video Cable to the VIDEO port on the camera.
2. Turn on your television.
3. Set the television to video mode according to the instructions in the owner's manual. (This is usually channel 3, 4 or AV).

USING THE TV AS A LIVE VIEWFINDER



1. Connect the camera to the TV with the supplied video cable .
2. Turn the camera on.
3. Slide the **Function** Switch to  (Capture mode).
4. The TV will become a Live Viewfinder.

REVIEWING PICTURES AND VIDEO CLIPS ON YOUR TV

1. Connect the camera to the TV.
2. Turn the camera on.
3. Slide the **Function** Switch to  (Playback mode).
4. Press the ▲ and ▼ button to scroll through the saved pictures and video clips.
 - When video file is displayed on the TV, press the **Enter** button to view the video clip.
5. To view more options, press the **MENU** button to display the menu on the TV screen.

TROUBLE SHOOTING

Problem	Possible Cause	Possible Solution
The camera is not running.	The power is not on.	Press the Power button to turn the camera on.
	The batteries were not loaded properly.	See " Loading the Batteries ".
	Batteries are depleted.	Replace with unused alkaline or fully recharged batteries (two AAA-size batteries).
	The battery cover is not closed properly.	Close the cover correctly and securely.
The camera is not taking pictures.	The camera is in the Playback Function mode.	Slide the function switch to Capture Function mode.
	The flash is charging.	Wait until the flash finishes charging. Press the shutter button when the indicator glows a steady orange.
	The SD card or internal memory is already full.	<ul style="list-style-type: none"> Obtain a new SD card and insert it. Download images to your computer, and then erase them from the card to free up more space. Delete unwanted files.
	The SD card is not formatted correctly.	<ul style="list-style-type: none"> Format the SD card with the camera. Ask SD card manufacturer for assistance.
Picture is not clear.	The lens is dirty.	Clean the lens.
Picture is too dark.	No enough light.	<ul style="list-style-type: none"> Use Fill flash during night time. Use Auto flash during daytime.
The pictures are blurred.	Viewfinder is dirty.	Clean the viewfinder with a soft cloth or cotton swab. See the Camera maintenance section.
	Hands were not steady when taking the picture.	Ensure hands are steady when taking picture and remain steady one second after clicking the Shutter button.
	The picture subject was not in the focus range of the camera.	Keep a minimum distance of 60 inches between the subject and the camera lens to stay in the focus range of the camera.
The pictures show on the LCD very slowly.	The picture size is large.	Select a smaller picture size, M picture size recommended.
The flash doesn't fire.	The flash mode is set to Off.	Set the flash to any other mode except Off.
There is something wrong with the color of the photographs.	White balance is not properly.	Reset the white balance feature to Auto, or for the specific lighting in the surrounding area.

Cannot take a picture or a video clip when using an SD memory card.	The SD card is locked or write protected.	Remove the SD card from the card slot and slide the lock switch to off.
Part of the picture/ video clip is missing.	Something was blocking the lens when taking the picture.	Keep hands, fingers, etc. away from the lens when taking a picture.
	The picture was not centered correctly in the viewfinder.	Leave space around the subject when centering the picture in the viewfinder.
Camera is not responding during picture capture.	The battery level is low and the camera does not have sufficient power to complete picture capture.	Replace batteries.
The LCD is not displaying anything.	LCD is turned off.	Turn the LCD on, by pressing the Enter button repeatedly until the LCD is on.
	The battery level is low.	Replace the batteries.
The camera does not recognize your SD card.	The card may not be SD certified.	Purchase a certified SD card.
	The card may be corrupted. Reformat the card.	Caution: Formatting erases all pictures on the card. (See P.21)
	No card is inserted in the camera.	Insert a card into the card slot. (See P. 9)
The computer cannot download files from the camera.	Camera power is off.	Turn on the camera.
	USB cable is not securely connected.	Connect cable to camera and computer port.
	Camera's mode is in capture  mode .	Shift the mode in  playback mode.

SPECIFICATION

Image Sensor	CMOS Sensor (2048 x 1536 pixel), Sensor area 1 / 2 "																			
Lens Specification	F 2.8, f = 8.34 mm																			
Focus Range	Normal: 1.5 m (4.92 ft.) to Infinity, Macro:40 cm - 50 cm (1.31 ft - 1.64 ft)																			
Operating System	Microsoft Windows 98SE / 2000 / ME / XP Support Image Download for MAC OS 10 or Later																			
Flash Strobe	Yes, (Auto, Flash On, Flash Off, Red Eye Reduction)																			
White Balance	Automatic / Daylight / Cloudy / Fluorescent / Tungsten																			
Exposure Control	Auto / Manual (-2EV ~ +2EV)																			
Video Mode	VGA, 640 x 480 Pixels, Up to 20fps QVGA 320 x 240 Pixels, Up to 25 fps																			
Storage Capacity (for 16 MB Built-In Memory) (approx.)	<p>Images Stored (approx.):</p> <table border="1"> <thead> <tr> <th rowspan="2">Image Quality</th> <th colspan="3">Image Size</th> </tr> <tr> <th>2400 x 1800</th> <th>2048 x 1536</th> <th>1024 x 768</th> </tr> </thead> <tbody> <tr> <td>Fine</td> <td>4</td> <td>5</td> <td>9</td> </tr> <tr> <td>Normal</td> <td>8</td> <td>11</td> <td>19</td> </tr> <tr> <td>Economy</td> <td>13</td> <td>17</td> <td>29</td> </tr> </tbody> </table>	Image Quality	Image Size			2400 x 1800	2048 x 1536	1024 x 768	Fine	4	5	9	Normal	8	11	19	Economy	13	17	29
Image Quality	Image Size																			
	2400 x 1800	2048 x 1536	1024 x 768																	
Fine	4	5	9																	
Normal	8	11	19																	
Economy	13	17	29																	
Compression	JPEG / MJPEG (AVI)																			
Zoom	4x Digital Zoom(max.)																			
Display	1.8" TFT LCD																			
RTC(Real-Time Clock)	Built-in (Date and Time)																			
PC Interface	USB 1.1																			
Video Output	NTSC/PAL																			
Storage Type	Built-in 16MB Flash Memory + SD Card Slot (Card Not Included)																			
Power	AAA 1.5V Batteries x 2																			
Bundled Software	Microsoft DirectX 9, Arcsoft Software and Adobe Acrobat Reader																			

GETTING HELP

TROUBLESHOOTING SECTION IN THIS USER'S GUIDE

Please refer to the Troubleshooting section first, as it contains some of the most common problems that users encounter.

WEBSITE CUSTOMER SUPPORT/FAQ

For problems that are not listed in the Troubleshooting section, please visit our customer support website at www.concord-camera.com to view the Frequently Asked Questions (FAQ) by clicking the appropriate camera model picture in the "Camera Support" Section. Most of the latest support issues are posted and answered in the FAQ section. If the problem you are encountering is not listed either in the troubleshooting section of this User's Guide or the FAQ section on our website, you can also E-mail us by clicking the E-mail address link to the customer support center in the "Camera Support" Section.

CUSTOMER SUPPORT

Before You E-mail or Call us

If you have questions concerning the operation of the camera or software installation that are not listed either in the troubleshooting section of this User's Guide or the FAQ section on our website, feel free to speak to or email a customer service representative. Before emailing or calling us, please have the following information ready:

Camera Information:

Name of camera model

Camera Serial Number

Computer Information:

Operating System

Computer Maker and Model

Exact Error message received

SAFETY TIPS AND MAINTENANCE

Cleaning the camera body

Please use a soft dry cloth to clean the camera.

Cleaning the lens and LCD

1. Blow off dirt or dust with a blower or canned air.
2. Gently wipe the lens and/or LCD with a micro-fiber cloth.
3. To remove dirt or residue, moisten the cloth with lens cleaning fluid and gently wipe the lens and/or LCD.

CAUTION: Do not apply the fluid directly onto the lens or LCD.

Cleaning the battery contacts

As a matter of routine operation and handling, should any debris or foreign contaminant deposit itself on the battery contacts in the camera and/or on the batteries, follow steps below to clean the battery contacts to ensure proper electrical operation:

1. Wet the tip of a cotton bud/swab with rubbing alcohol and squeeze the excess alcohol from the bud/swab.
2. Wipe the battery contacts inside the camera battery compartment and both ends of the batteries lightly with the damp bud.
3. Allow the contacts to dry before placing batteries in the camera.

Caution:

- 1) Do not press hard during cleaning, as this will cause damage to the battery contacts.
- 2) Do not use water to clean the contacts, as this will increase the chance of oxidation.
- 3) Do not use Acetone or Nail Polish remover to clean the contacts as this may adversely affect camera operation.

SAFETY TIPS

Precautions for the camera

- Do not attempt to modify this camera in any way. This may cause a fire, electric shock or severe damage to the camera.
- Do not use the flash in close proximity to people or animals.
- When taking photographs, never point the lens of the camera directly into very strong light.
- Please do not use this product in close proximity to flammable or explosive gases as this could increase the risk of explosion.
- For safety reasons keep this product and accessories out of reach of children or animals to prevent accidents.

- Do not swallow batteries or small camera accessories.
- Keep the camera away from water and other liquids, and never let it get wet. Do not use outdoors when it is raining or snowing.
- Should any form of liquid enter the camera, do not use it. Switch the camera off, and then remove the batteries. Do not continue to use the camera as this may cause a fire or electric shock.
- Do not insert or drop metallic or inflammable foreign objects into the camera through access points e.g. card slot and battery chamber. This may cause a fire or electric shock.
- Do not operate this camera with wet hands. This could pose a risk of electric shock.
- Under the environment with electrostatic discharge, the camera may malfunction and require the user to reset the camera.
- Under the environment with electrical fast transients (EFT), the camera may lose function and require user to reset the camera.
- Shielded cables must be used with this unit to ensure compliance with the Class B FCC limits.
- Please avoid using the camera in high or low temperature. Operation temperature range 32°F-104°F(0°C-40°C).
- It is normal that the temperature of the camera body rises after being in use for a long period.
- Do not leave this camera in places subject to extremely high temperatures such as in a sealed vehicle, direct sunlight or other places with extreme variances in temperature. Exposure to extreme temperatures may adversely affect the camera's internal components and could cause a fire.
- Always use the camera and its accessories in a well-ventilated area.
- Allowing dust to accumulate in the camera over a long period of time is hazardous and in extreme circumstances may cause a fire. It is best to clean your camera prior to seasonal periods of high humidity.

Precautions for batteries

- Dispose of the battery in a manner that complies with applicable laws.
- Leakage, overheating, or burst battery could result in fire or injury.
- Do not short circuit, heat or dispose of batteries in fire.
- Ensure the battery is positioned correctly with regard to polarity.
- Battery may lose power if kept inside the camera for a long time without using. Please remove the battery while the camera is not in use.
- Batteries may not work normally under 32°F(0°C).

Precautions for SD Memory Cards

- In the event of malfunction or damage, it is possible that data may be lost. Concord Camera is not responsible in any way for such data loss.
- Do not touch the terminals with hands or metal objects.
- Keep dust, water and foreign objects away from the terminal section.

- Avoid heat, liquid and direct sunlight when using and for when storing.
- Do not open the battery/card cover or remove the SD Memory Card while data is being read or written.
- Do not dismantle or modify.
- The recorded data may be lost if the card is affected by strong static electricity, electrical shock, during card repair or malfunction.
- When using SD Memory Cards do not change the attributes (read-only, etc.) of the files (pictures (JPEG) or video clips (AVI) on the card. Doing so may prevent the camera from working properly when deleting, etc.
- Do not change the file names or the directory name of the pictures or video clips using a computer or save files other than pictures or video clips taken by this camera onto the SD memory card. Pictures or video clips that have been edited or added to the SD memory card with the computer may not play back and it may cause the camera to malfunction.
- The SD Memory Card includes a write-protect switch. Sliding this switch downward prevents data from being written to the card and pictures and video clips saved on the card are protected.
- Please note that pictures and video clips cannot be taken or deleted when the write-protect switch is on.
- When using a large-capacity card, writing, reading and deleting may take some time.
- Do not store the card in places with high humidity, dusty places or where static electricity or electromagnetic fields are likely to occur.
- Images stored in the memory card may be ruined or damaged if you turn off the camera while it is in process of reading, writing or formatting etc.
- SD cards are delicate electronic devices. Please do not bend or drop them
- Please do not place the SD card in or near to an environment of strong electronic or magnetic fields such as loud speakers or TV receivers.
- Please keep the SD card in its bag or case when not in use.
- It's normal that the SD card is warm after use.
- Please make sure you switch off the camera before you remove the SD card.
- Do not open the battery/memory card door or remove the SD Memory Card while the camera is reading, writing or formatting the card.

REGULATORY INFORMATION

FCC INFORMATION

FCC WARNING: This equipment meets the limits for a Class B digital device, pursuant to Part 15 of FCC rules. Only the cable supplied with the camera should be used. Operation with other cables is likely to result in interference to radio and TV reception and could void the user's authorization to operate this equipment. This device complies with Part 15 of the FCC Rules. Operation is subject to the following two conditions:

- This device may not cause harmful interference.
- This device must accept any interference received, including interference that may cause undesired operation.

***Tested to comply
with FCC standards
for HOME OR OFFICE USE***

Changes or modifications not expressly approved by the manufacturer may void the user's authority to operate this equipment.

USER INFORMATION

NOTE: This equipment has been tested and found to comply with the limits for a class B digital device, pursuant to Part 15 of the FCC Rules. These limits are designed to provide reasonable protection against harmful interference in a residential installation. This equipment generates uses and can radiate radio frequency energy and, if not installed and used in accordance with the instructions, may cause harmful interference to radio communications. However, there is no guarantee that interference will not occur in a particular installation.

If this equipment does cause harmful interference to radio or television reception, which can be determined by turning the equipment on and off, the user is encouraged to try to correct the interference by one or more of the following measures:

- Reorient or relocate the receiving antenna.
- Increase the separation between the equipment and receiver.
- Connect the equipment into an outlet on a circuit different from that to which the receiver is connected.
- Consult the dealer or an experienced radio/TV technician for help.

 - This product is in conformity with Directive 89/336/EEC.

Concord and the Concord logo are registered trademarks or trademarks of Concord Camera Corp., in the United States and/or other countries. Microsoft and Windows are either registered trademarks or trademarks of Microsoft Corporation in the United States and/or other countries. Mac and Macintosh are registered trademarks or trademarks of Apple Computer, Inc. in the U.S. and other countries. All other brands and product names are either registered trademarks or trademarks of their respective owners.

Visit Concord on the Internet

www.concord-camera.com

CONCORD 3043 User's Guide

Copyright 2005 Concord Camera Corp.

Version 1.0

582106-01

R1