

Epson Stylus® NX125/127 Series



Quick Guide

Basic Copying, Printing, and Scanning
Maintenance
Solving Problems

Contents

Loading Paper	3
Using Special Papers	6
Copying a Document or Photo	7
Placing Originals on the Glass	7
Copying Documents and Photos	8
Printing From Your Computer	9
Printing in Windows	9
Printing With a Macintosh	11
Selecting the Correct Paper Type	14
Scanning a Document or Photo	15
Quick Scanning With the Scan Function	15
Scanning With Epson Scan Software	16
Scanning with Mac OS X 10.6	17
Restoring and Correcting Photos	18
Maintaining Your Printer	19
Checking the Print Head Nozzles	19
Cleaning the Print Head	20
Checking Ink Levels	21
Purchasing Epson Ink Cartridges	22
Replacing Ink Cartridges	23
Solving Problems	27
Checking for Software Updates	27
Error Indicators	28
Problems and Solutions	29
Where to Get Help	32
Notices	33

Loading Paper

You can print documents and photos on a variety of paper types and sizes. For details, see page 6. (For instructions on loading envelopes, see your online *User's Guide*.)

1. Open the paper support, pull up the extension, and then tilt it back.
2. Lower the output tray, then open the extension.

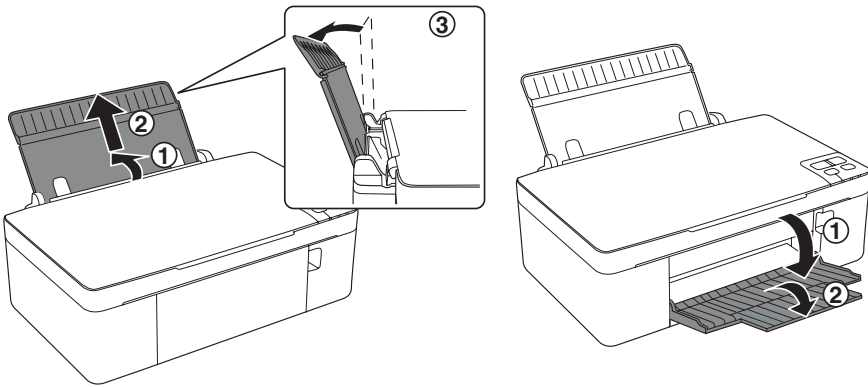

3. Flip the feeder guard forward.

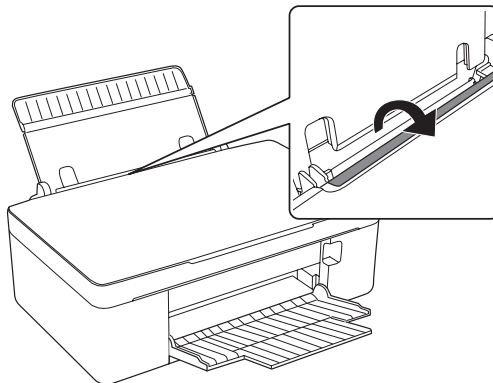

4. Squeeze the edge guide and slide it all the way to the left.

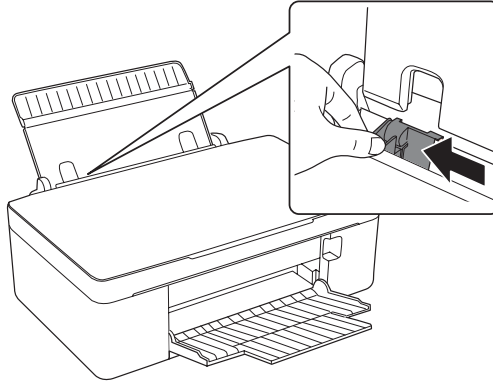

5. Load paper against the right edge and behind the tab with the glossy or printable side face up. (Load letterhead or pre-printed paper top edge first.)

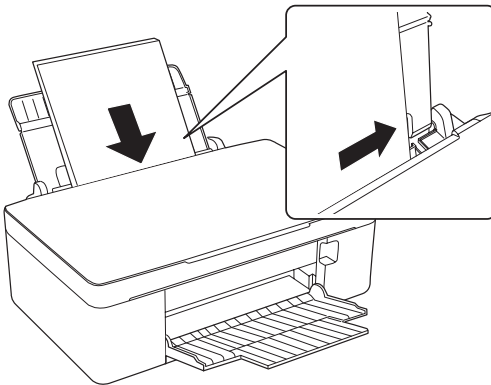

Always load paper short edge first, don't load it sideways.

You can load up to 100 sheets of letter- or A4-size plain paper, 80 sheets of Bright White or Presentation Paper Matte, or 10 sheets of Premium Photo Paper Glossy (4 × 6 inch only). Load all other papers one sheet at a time. See your online *User's Guide* for more information.

Note:

Don't load paper with holes punched in it.

The type of paper you choose affects the way your printout looks. If you are just making a copy or printing a rough draft, plain paper is fine. However, for the best results, you'll want to use one of Epson's special ink jet papers designed for your printer. For example, your photos will look great printed on Epson Premium Photo Paper Glossy (see page 6 for more information).

4 Loading Paper

6. Squeeze the edge guide and slide it against the paper, but not too tightly.

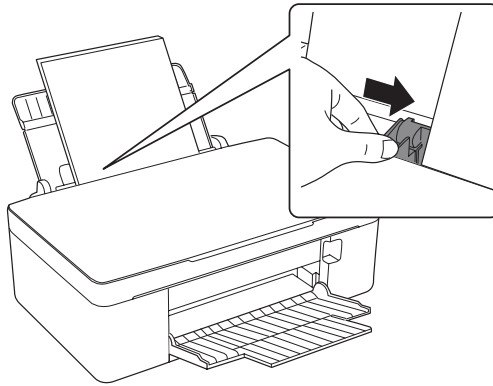

7. Flip the feeder guard back.

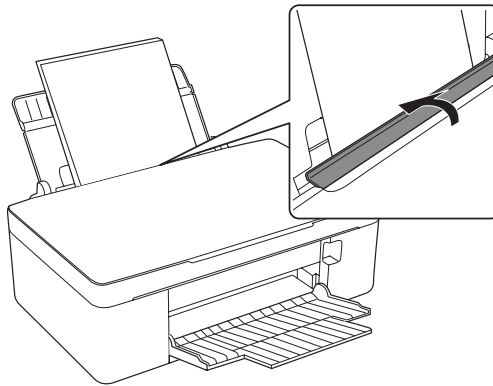

Using Special Papers

Epson offers a wide array of high quality papers, making it easy to maximize the impact of your photos, presentations, and creative projects.

You can purchase genuine Epson ink and paper at Epson Supplies CentralSM at www.epson.com/ink3 (U.S. sales) or www.epson.ca (Canadian sales). You can also purchase supplies from an Epson authorized reseller. To find the nearest one, call 800-GO-EPSON (800-463-7766).

Paper type	Size	Part number	Sheet count
Epson Premium Photo Paper Glossy	Borderless 4 × 6 inches	S041808 S041727	40 100
	Borderless 5 × 7 inches	S041464	20
	Borderless 8 × 10 inches	S041465	20
	Letter (8.5 × 11 inches)	S042183 S041667	25 50
Epson Premium Photo Paper Semi-gloss	Borderless 4 × 6 inches	S041982	40
	Letter (8.5 × 11 inches)	S041331	20
Epson Photo Paper Glossy	Borderless 4 × 6 inches	S041809 S042038	50 100
	Letter (8.5 × 11 inches)	S041141	20
		S041649	50
S041271		100	
Epson Bright White Paper	Letter (8.5 × 11 inches)	S041586	500
Epson Presentation Paper Matte	Letter (8.5 × 11 inches)	S041062	100
	Legal (8.5 × 14 inches)	S041067	100
Epson Premium Presentation Paper Matte	Borderless 8 × 10 inches	S041467	50
	Letter (8.5 × 11 inches)	S041257 S042180	50 100
Epson Premium Presentation Paper Matte Double-sided	Letter (8.5 × 11 inches)	S041568	50
Epson Ultra Premium Presentation Paper Matte	Letter (8.5 × 11 inches)	S041341	50
Epson Photo Quality Self-adhesive Sheets	A4 (8.3 × 11.7 inches)	S041106	10
Epson Iron-on Cool Peel Transfer Paper	Letter (8.5 × 11 inches)	S041153	10

Copying a Document or Photo

Follow the instructions in this section to position your originals correctly on the scanner glass and make color or black-and-white copies.

Placing Originals on the Glass

1. Open the document cover and place your original face-down on the scanner glass, with the top facing into the front right corner.

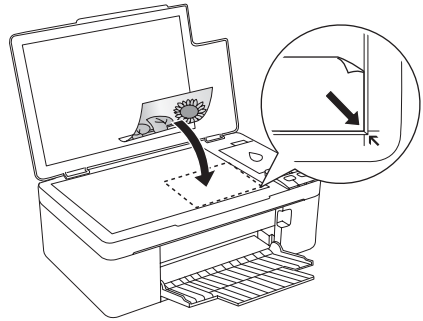
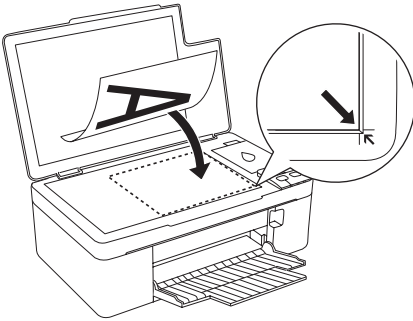



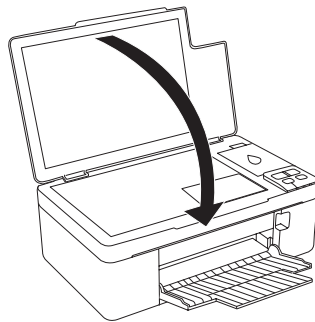
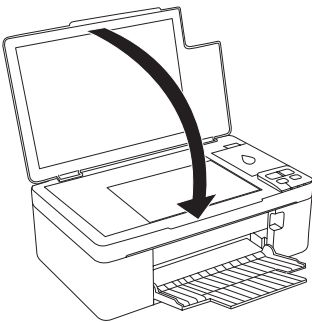

2. Close the cover gently so you don't move the original.



Copying Documents and Photos

You can copy documents and photos onto letter- or A4-size plain paper or Epson special paper.

1. Load paper in the sheet feeder (see page 3).
2. Place your original document on the scanner glass (see page 7).
3. Press the  **B&W Copy** button (for a black-and-white document or photo) or the  **Color Copy** button (for a color document or photo) to start copying.
4. To make 20 copies at a time, press and hold either the  **B&W Copy** button or the  **Color Copy** button for three seconds.

To cancel copying, press the  **Stop** button.

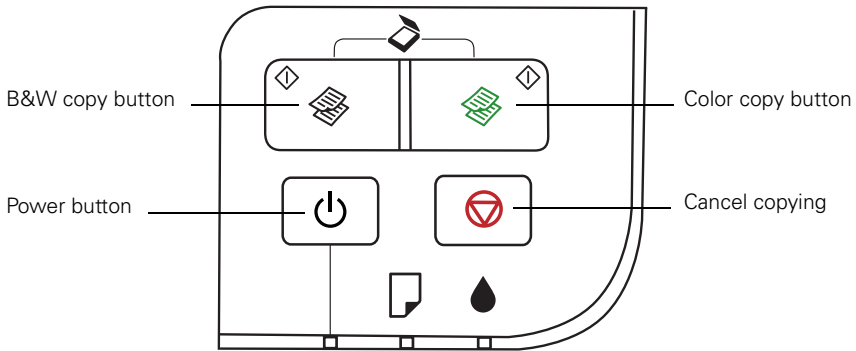

Printing From Your Computer

This section describes the basic steps for printing from a Windows or Macintosh computer. For detailed instructions on printing, see the online *User's Guide*.

Before you start, make sure you've installed your printer software and connected your Epson printer to your computer as described on the *Start Here* sheet.

Tip:

It's a good idea to check for updates to your Epson printer's software (see page 27 for instructions).

Printing in Windows

1. Open a photo or document in a Windows program.
2. Open the File menu and select **Print**. You see a window like this one:

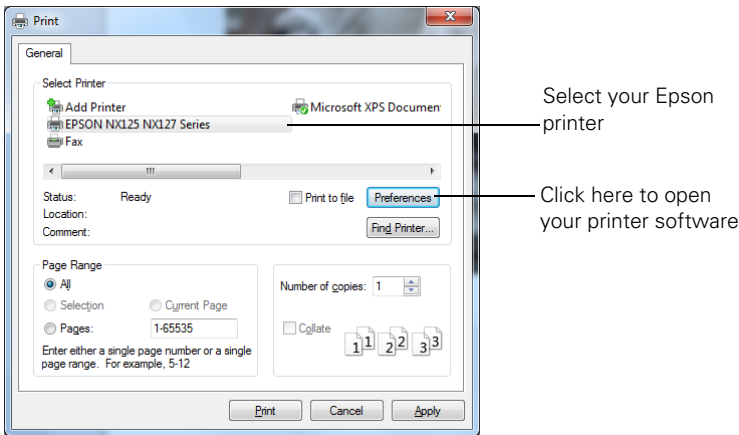

3. Make sure your Epson printer is selected, then click the **Preferences** or **Properties** button.

(If you see a **Setup**, **Printer**, or **Options** button, click it. Then click **Preferences** or **Properties** on the next screen.)

4. On the Main tab, select the basic print settings. Make sure you choose the correct paper **Type** setting for the paper you are using (see page 14 for details).

Select the type of document you're printing
(choose **Photo** or **Best Photo** for pictures)

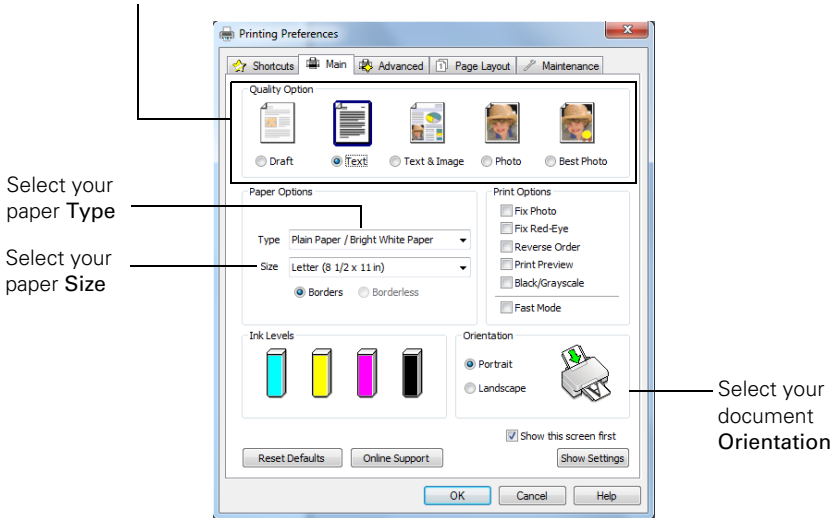

Note:

For quick access to the most common settings, click the **Shortcuts** tab and select one of the presets. You can create your own presets by clicking the **Save Settings** button on the **Advanced** tab.

5. If you want to reduce or enlarge your printout, or print double-sided, click the **Page Layout** tab and select settings as necessary.
6. For more printing options, click the **Advanced** tab.

Note:

For more information about print settings, click **Help** or see your online *User's Guide*.

7. Click **OK** to save your settings.

8. Click **OK** or **Print** to start printing. This window appears and shows the progress of your print job.

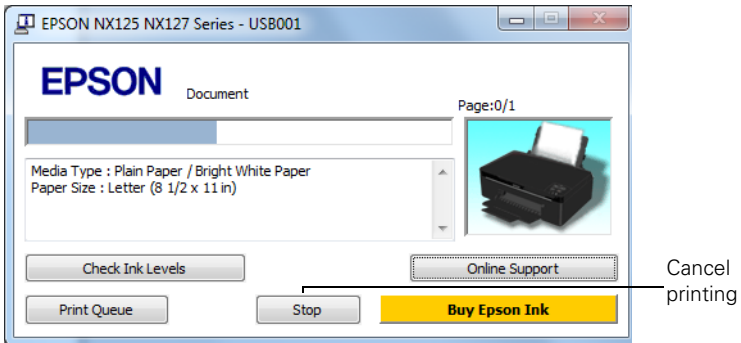

Printing With a Macintosh

Follow the steps below to print from Mac OS X 10.5 to 10.6.

Note:

If you're printing from Mac OS X 10.4, see your online *User's Guide* for instructions.

1. Open a photo or document in an application.
2. Open the **File** menu and select **Print**.
3. Select your Epson printer as the **Printer** setting.

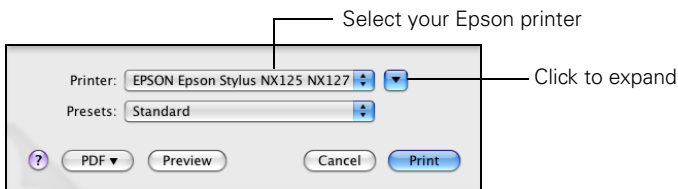

4. Click the arrow to expand the Print window, if necessary.

5. Select basic copy and page settings. For borderless printing, choose a **Paper Size** setting with a **Sheet Feeder - Borderless** option.

Note:

If the setting you want isn't shown (for example, **Scale**), check for it in your application before printing. Or check for it in the settings for your application at the bottom of this window.

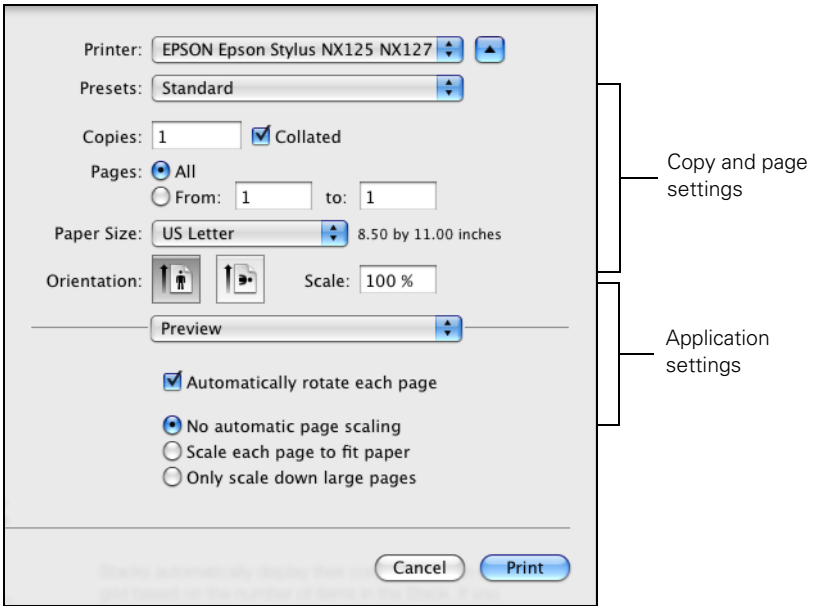

6. Choose **Print Settings** from the pop-up menu, and select the following print settings:

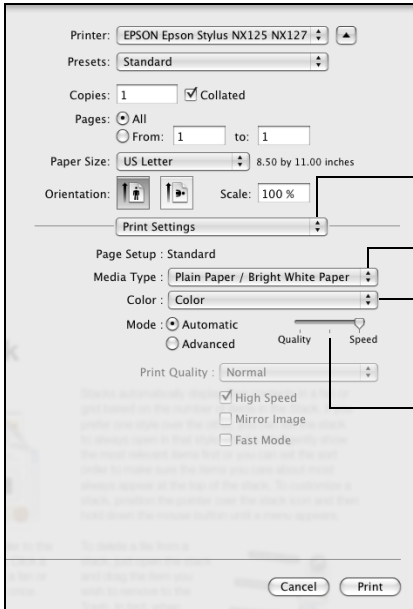

Choose **Print Settings**

Select your **Media Type**
(see page 14)

Select **Color** or
Black/Grayscale

Select higher quality or
faster printing (if available)

7. Choose any other printing options you may need from the pop-up menu. See the online *User's Guide* for details.
8. Click the **Advanced** button to change additional settings.

Note:

For more information on advanced settings click ?.

9. Click **Print**.

10. To monitor your print job, click the  printer icon in the dock.

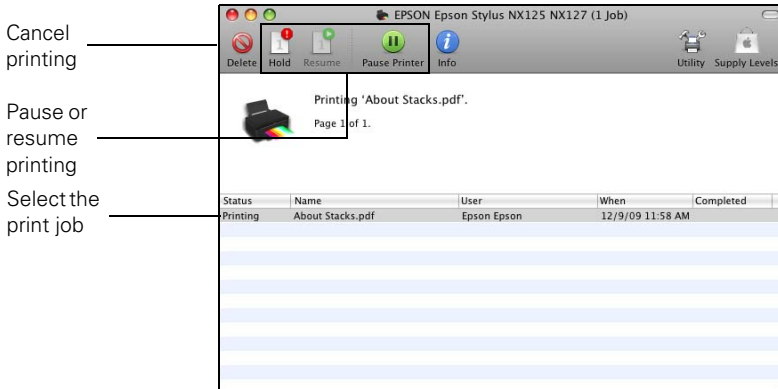

Selecting the Correct Paper Type

Select the correct **Type** (see page 10) or **Media Type** (see page 11) setting in your printer software. This tells your Epson printer what kind of paper you're using, so the ink coverage can be adjusted accordingly.

For this paper	Select this setting
Plain paper Epson Bright White Paper Epson Presentation Paper Matte Epson Iron-on Cool Peel Transfer Paper	Plain Paper/Bright White Paper
Epson Premium Photo Paper Glossy	Premium Photo Paper Glossy
Epson Photo Paper Glossy	Photo Paper Glossy
Epson Premium Photo Paper Semi-gloss	Premium Photo Paper Semi-Gloss
Epson Premium Presentation Paper Matte Epson Premium Presentation Paper Matte Double-sided Epson Photo Quality Self-adhesive Sheets	Premium Presentation Paper Matte
Envelopes	Envelope

Scanning a Document or Photo

You can use your Epson Stylus NX125/127 Series to scan a photo or document and save it on your computer. The **Scan** function lets you scan quickly using preselected settings, or you can use the Epson Scan software to access more advanced features. For example, you can use Epson Scan to restore faded colors in old photos (see page 18).

Note:

For detailed scanning instructions, see the online *User's Guide*.

Quick Scanning With the Scan Function

Use the **Scan** function to quickly scan a photo or document and save it on your computer.

Note:

For Mac OS X 10.6, see “Scanning with Mac OS X 10.6” on page 17.

1. Open the document cover and place your original face-down on the glass, in the front right corner, as shown on page 7.
2. Close the cover gently so you don't move the original.
3. Press the **B&W Copy** and the **Color Copy** buttons simultaneously. Your NX125/127 Series will automatically default to the **Scan to PDF** setting and scan your image.

Note:

For instructions on how to change the scan settings, see the online *User's Guide*.

Once your image is scanned, you see its icon in Windows Explorer or Macintosh Finder, depending on the option you selected.

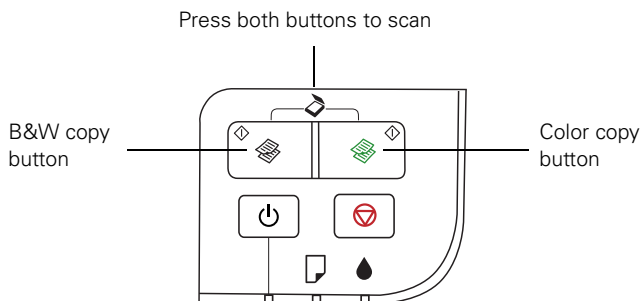

Scanning With Epson Scan Software

You can scan original documents and photos and save them as files on your computer using the Epson Scan software. You can also launch Epson Scan from any TWAIN-compliant application, such as Adobe® Photoshop®.

Note:

For Mac OS X 10.6, see "Scanning with Mac OS X 10.6" on page 17.

1. Open the document cover and place your original face-down on the glass, in the front right corner, as shown on page 7.
2. Close the cover gently so you don't move the original.
3. Do one of the following to start Epson Scan:
 - **Windows:**
Double-click the EPSON Scan icon on your desktop.
 - **Macintosh:**
Double-click EPSON Scan in the Applications folder.
 - If you are scanning from an application, start your application. Then open the File menu, choose **Import** or **Acquire**, and select your Epson product.

You see the Epson Scan window:

4. Select **Full Auto Mode** as the Mode setting in the upper right corner. (If you are in Home, Office, or Professional Mode, you see a different Epson Scan window.)
5. If you want to restore faded color in a photo or make other corrections, click **Customize**. Then follow the instructions on page 18.
6. Click the **Scan** button. The image is scanned and you see its icon in Windows Explorer or Macintosh Finder.

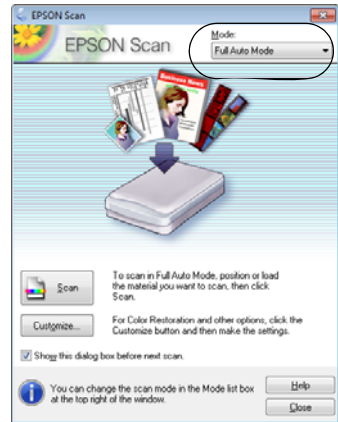

Scanning with Mac OS X 10.6

You can scan original documents and photos and save them as files on your computer.

1. Open an image editing application such as Preview and select **Import From Scanner** from the File menu, then select your Epson product.
2. Click the **Scan** button to begin scanning. Your image is saved to the folder selected in the **Scan To** pop-up menu.

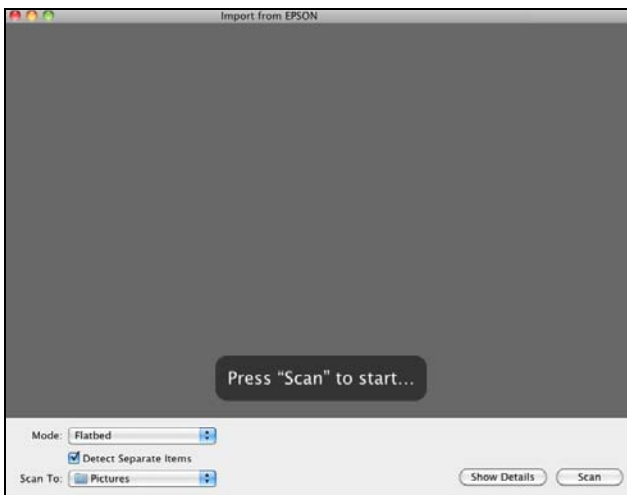

Restoring and Correcting Photos

You can automatically transform a faded, dusty, or badly exposed color photo into one with true-to-life color and sharpness as you scan. Use the **Color Restoration** and **Dust Removal** options in Epson Scan's Full Auto Mode. In Home and Professional Mode, you can also select **Backlight Correction** to remove shadows from images with too much background light.

Note:

For Mac OS X 10.6, see "Scanning with Mac OS X 10.6" on page 17 to start scanning, click the **Show Details** button, and select settings as necessary.

Full Auto Mode

Click the **Customize** button, click **Dust Removal** and/or **Color Restoration**, click **OK**, and click **Scan**.

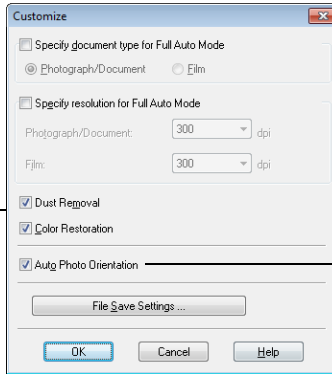

Automatically orients your photos based on detected faces and other features. If your photo is not oriented correctly, turn off **Auto Photo Orientation** and try again.

Note:

For more information, see the online *User's Guide*. You can also click **Help** on the Epson Scan screen for information about all the available settings.

Maintaining Your Printer



Follow the instructions in this chapter for checking and cleaning the print head nozzles and replacing ink cartridges. To align the print head, if necessary, see your online *User's Guide*.

Caution:

To keep your printer looking like new, don't place anything on top of the cover or use it as a writing surface. If you need to clean the cover, use only a soft, non-abrasive microfiber-type cloth.

Checking the Print Head Nozzles

If your printouts are faint or have gaps in them, some of the nozzles in the print head may be clogged or ink may be running low in one or more of the ink cartridges. Follow the steps below to check the print head nozzles.

1. Load letter- or A4-size paper in the sheet feeder (see page 3).
2. Turn off the printer.
3. Hold down the  Stop button as you press the  Power button to turn the printer back on. Hold down both buttons until the  Power light begins to flash, then release the buttons.

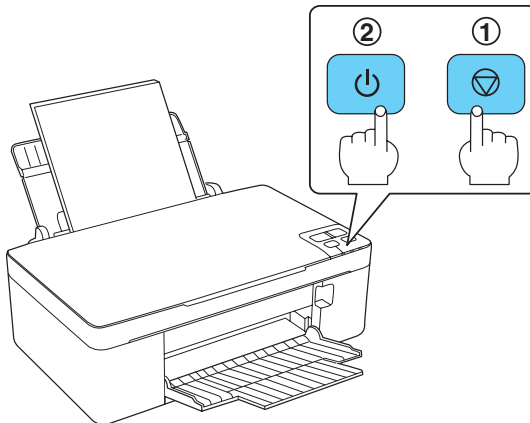

4. Check the nozzle check pattern that prints to see if there are gaps in the lines.

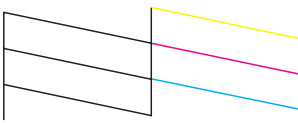

Nozzles are clean

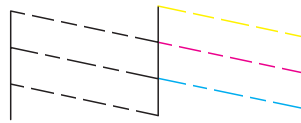

Nozzles need cleaning

5. If there are no gaps, the print head is clean and you can continue printing.
If there are gaps or the pattern is faint, clean the print head (see below).

Cleaning the Print Head

If print quality has declined and the nozzle check pattern indicates clogged nozzles, you can clean the print head. Print head cleaning uses ink, so clean it only if necessary.

Note:

You cannot clean the print head if an ink cartridge is expended, and may not be able to clean it when a cartridge is low. You must replace the cartridge first (see page 23).

1. Make sure no printer lights are indicating errors.
2. Load letter- or A4-size paper in the sheet feeder (see page 3).
3. Hold down the  Stop button for 3 seconds to start the cleaning cycle.

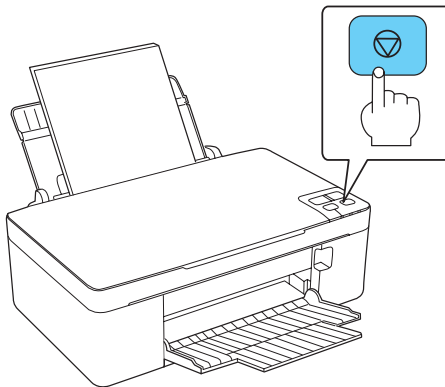

Cleaning takes approximately one minute. The  Power light flashes throughout the cleaning cycle and stays on green when the cleaning cycle is finished.

Caution:

Never turn off the printer during head cleaning or you may damage it.

4. Run a nozzle check (as described on page 19) to verify that the print head is clean.
5. If there are still gaps or lines, or the test patterns are faint, run another cleaning cycle and check the nozzles again.



Note:



If you don't see any improvement after cleaning the print head four times, turn off the printer and wait at least six hours to let any dried ink soften. Then try cleaning the print head again. If quality does not improve, one of the ink cartridges may need to be replaced. If that doesn't help, contact Epson as described on page 32.

If you do not use your Epson printer often, it is a good idea to print a few pages at least once a month to maintain good print quality.

Checking Ink Levels

Your printer and its software will let you know when an ink cartridge is low or expended.

If the ink is low, the  error and  ink lights flash. You can continue printing until the cartridge needs replacement.

If a cartridge is expended, the  error and  ink lights stay on. You must replace the cartridge to be able to print.

Note:

You cannot print or copy when an ink cartridge is expended even if the other cartridges are not expended. Replace any expended cartridges before printing or copying.

You can check ink cartridge levels using your printer software:

- **Windows:** Double-click the  printer icon in the bottom right corner of your screen (the taskbar).
- **Macintosh:** Open the **Applications** folder on your hard drive, then open the **EPSON Printer Utility4**. Select your Epson printer and click **OK**, then select **EPSON StatusMonitor**.

A window may also appear on your computer screen when you try to print when ink is low. This window can optionally display ink offers and other updates from Epson.

Note:

To disable checking for ink offers or updates from Epson, see the instructions in your online *User's Guide*.

Purchasing Epson Ink Cartridges

You can purchase genuine Epson ink and paper from Epson Supplies Central at www.epson.com/ink3 (U.S. sales) or www.epson.ca (Canadian sales). You can also purchase supplies from an Epson authorized reseller. To find the nearest one, call 800-GO-EPSON (800-463-7766).

Use the following list when you order or purchase new ink cartridges:

Ink color	Moderate-capacity (For lighter use)	Standard-capacity
Black	124	125
Cyan	124	125
Magenta	124	125
Yellow	124	125

Note:

We recommend that you use genuine Epson cartridges and do not refill them. The use of other products may affect your print quality and could result in printer damage.

Yields vary considerably based on images printed, print settings, paper type, frequency of use, and temperature. For print quality, a small amount of ink remains in the cartridge after the “replace cartridge” indicator comes on. Your printer ships with full cartridges and part of the ink from the first cartridges is used for priming the printer.

For best printing results, use up a cartridge within six months of opening the package, and before the expiration date on the cartridge box.

Store ink cartridges in a cool, dark place. If cartridges have been exposed to cold temperatures, allow them to warm up to room temperature for at least 3 hours before using them.

Replacing Ink Cartridges



Make sure you have a new ink cartridge before you begin. You must install new cartridges immediately after removing the old ones.

Caution:

Do not open ink cartridge packages until you are ready to install the ink. Cartridges are vacuum packed to maintain reliability.

Note:

Leave the expended cartridge installed until you have obtained a replacement, or the ink remaining in the print head nozzles may dry out.

1. Turn on your printer.
2. If an ink cartridge is expended, the  error and  ink lights on the control panel stay on.
3. Open the document cover, then open the ink cover.

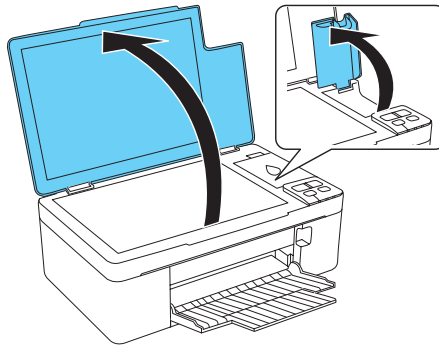



Caution:

Do not remove the ink cartridge guard or you may damage the printer.

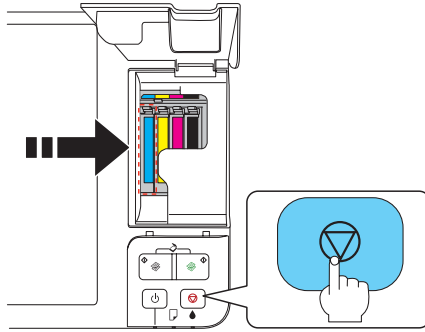
4. Press the  Stop button.



If a cartridge is low or expended, the print head moves that cartridge to the replacement position to indicate that it should be replaced. The  Power light starts flashing.

If two or more ink cartridges are expended, the expended cartridge at the far left moves to the replacement position. The  Power light starts flashing.

If no cartridges are low or expended, the print head does not move.

Note:

Do not hold the  Stop button for more than three seconds, or the printer may start cleaning the print head.

5. Squeeze the tab on the cartridge and lift it up. Dispose of it carefully. Do not take the used cartridge apart or try to refill it.

Warning:

If ink gets on your hands, wash them thoroughly with soap and water. If ink gets into your eyes, flush them immediately with water. Keep ink cartridges out of the reach of children.

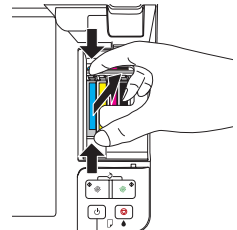

- Before you open the new cartridge package, shake it gently four or five times. Then remove the cartridge from the package.

Caution:

Do not touch the green chip on the front of the cartridge. This can damage the ink cartridge.



- Remove the yellow tape from the bottom of the ink cartridge.

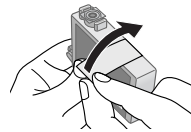



Caution:

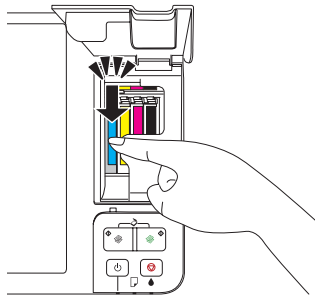
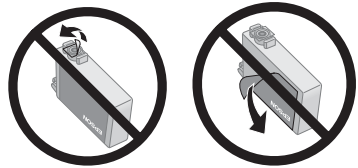

Do not remove any other labels or seals, or ink may leak.

- Insert the new ink cartridge into the holder and push it down until it clicks into place.



- Press the  Stop button. If another cartridge is low or expended, it moves to the replacement position. Repeat steps 5 through 8 to replace any other cartridges that need to be replaced.



When you press the  Stop button and no other cartridges need to be replaced, the print head moves to its home position and the printer starts priming the ink. This takes about 1 1/2 minutes.

When the  Power light stops flashing and the  error and  ink lights go out, ink charging is finished.

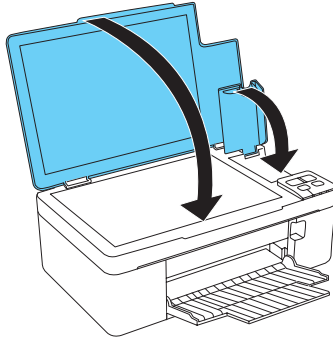
10. Close the ink cover, then close the document cover.



Caution:

Never turn off the your Epson printer while ink is charging or you'll waste ink. If the  error and  ink lights remain on after the print head moves into its home position, an ink cartridge may not be installed properly. Press the  Stop button again, and then press the ink cartridge down securely.

Note:

If you replaced a cartridge while copying a document or photo, cancel printing and make sure your original is still placed correctly on the document table. Then copy your original again.

If you remove a low or expended ink cartridge, you cannot reinstall and use the cartridge.

Solving Problems

If you have a problem with your Epson printer, check the status of lights on the control panel to diagnose the cause (see “Error Indicators” on page 28).

You can also check “Problems and Solutions” on page 29 for basic troubleshooting suggestions, or double-click the *User’s Guide* icon on your computer desktop for more detailed help.

Checking for Software Updates



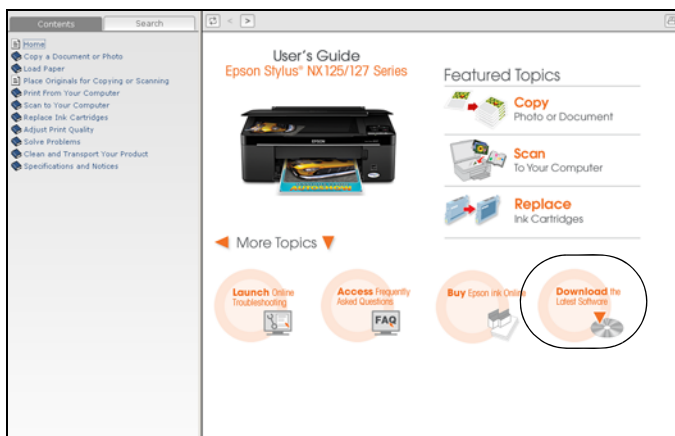





Periodically, it’s a good idea to check Epson’s support website for free updates to your NX125/127 Series software. Open your online *User’s Guide* and select **Download the Latest Software** or visit Epson’s support website at epson.com/support (U.S.) or epson.ca/support (Canada).



With Windows, you can select **Driver Update** on the Maintenance tab in the printer settings window. You can also click **Start** or , select **Programs** or **All Programs**, select **EPSON**, select **EPSON NX125 NX127 Series**, and click **Driver Update**.

Error Indicators

You can often diagnose problems with your printer by checking the status of lights on the control panel. If you see one of the error indicators below, follow the steps here to proceed.

Light status	Problem and solution
 power on	The printer is turned on.
 power flashing (slow)	The printer is busy. Wait for the  power light to stop flashing before turning off the printer.
 power flashing (fast)	The printer is being turned off.
 error on or flashing	Paper may be out. Load more paper in the sheet feeder and press the  stop button to continue (see page 3).
	If multiple sheets have fed into the sheet feeder, reload the paper and press the  stop button to resume printing.
	Paper may have jammed in the sheet feeder. Open the document cover and remove any paper jammed inside. See your online <i>User's Guide</i> for more information.
	An ink cartridge is expended or not installed correctly, or is not compatible with the printer. Replace or reinstall the ink cartridge (see page 23).
 ink flashing	Ink in a cartridge is low. You can continue printing, or check which cartridge is low and replace it (see page 23).
 ink on	An ink cartridge is expended or not installed correctly, or is not compatible with the printer. Replace or reinstall the ink cartridge (see page 23).

Problems and Solutions

Check the solutions below if you're having trouble using your Epson printer.

Printing and Copying Problems

- Make sure your original is positioned in the front right corner of the glass. If the edges are cropped, move your original away from the edges slightly.
- Make sure your paper is loaded short edge first and is positioned against the right side with the edge guide against its left side. Don't load paper above the arrow mark inside the edge guide.
- Make sure the paper size settings are correct for the paper you loaded.

Paper Feeding Problems

- If paper doesn't feed, remove it from the sheet feeder. Flip through the stack to separate the sheets a little. Then reload the paper against the right side, and slide the left edge guide against the paper (but not too tightly).
- Do not load too many sheets at once. You can load up to 100 sheets of letter- or A4-size plain paper, 80 sheets of Bright White or Presentation Paper Matte, or 10 sheets of Premium Photo Paper Glossy (4 × 6 inch only). Load all other papers one sheet at a time. See your online *User's Guide* for more information.
- Do not load paper with holes punched in it.
- If paper is jammed, follow these steps:
 1. Gently pull out jammed paper from the output tray or sheet feeder.
 2. If paper is stuck inside, press either of the copy buttons to eject the paper. Remove any jammed paper and torn pieces. If the error light is still lit, turn off your Epson printer.

3. If paper remains near the sheet feeder, press the paper feed roller lever inside the sheet feeder to release the jammed paper, then carefully pull it out.

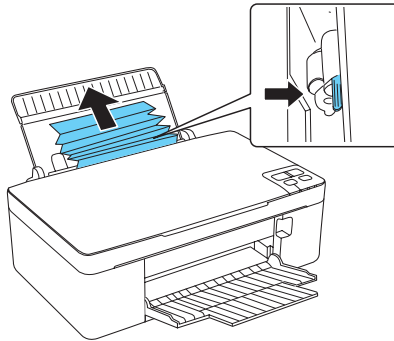

4. Raise the paper jam cover, carefully remove the jammed paper, then close the paper jam cover and turn the printer back on.

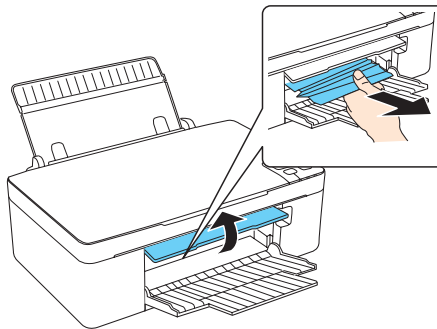

Print Quality Problems

If you have any problems with the copy or print quality, try these solutions:

- Make sure the document is placed flat against the document table glass and your Epson printer is not tilted or placed on an uneven surface.
- Load the paper printable side up (usually the whiter, brighter, or glossy side).
- Make sure your paper isn't damp or curled.
- Use a support sheet with special paper or load your paper one sheet at a time. Remove sheets from the output tray so not too many collect at a time.
- Make sure the type of paper you loaded matches the paper size and paper type settings in your printer software (see page 14).
- For the best print quality, use Epson special paper (see page 6) and genuine Epson ink cartridges (see page 21).
- If you notice light or dark bands across your printouts or they are too faint, you may need to clean the print head (see page 20). This unclogs the nozzles so they can deliver ink properly. Run a nozzle check as described on page 19 to see if the print head needs cleaning.
- Clean the print head as described on page 20.
- If you notice jagged vertical lines, you may need to align the print head. See your online *User's Guide* for instructions.
- The ink cartridges may be low on ink. Check your cartridge status (see page 21) and replace cartridges, if necessary (see page 23).
- If a dotted line appears in a scanned image, clean the document table glass with a soft, dry, lint-free cloth (paper towels are not recommended and may permanently scratch the surface), or use a small amount of glass cleaner on a soft cloth, if necessary. Do not spray glass cleaner directly on the glass.

Where to Get Help

Internet Support

Visit Epson's support website at epson.com/support (U.S.) or epson.ca/support (Canada) and select your product for solutions to common problems. You can download drivers and documentation, get FAQs and troubleshooting advice, or e-mail Epson with your questions.

Speak to a Support Representative

Before you call Epson for support, please have the following information ready:

- Product name (Epson Stylus NX125/127 Series)
- Product serial number (located on the label in back)
- Proof of purchase (such as a store receipt) and date of purchase
- Computer configuration
- Description of the problem

Then call:

- U.S.: (562) 276-4382, 6 AM to 6 PM, Pacific Time, Monday through Friday.
- Canada: (905) 709-3839, 6 AM to 6 PM, Pacific Time, Monday through Friday.

Days and hours of support are subject to change without notice. Toll or long distance charges may apply.



Purchase Supplies and Accessories

You can purchase genuine Epson ink and paper at Epson Supplies Central at www.epson.com/ink3 (U.S. sales) or www.epson.ca (Canadian sales). You can also purchase supplies from an Epson authorized reseller. To find the nearest one, call 800-GO-EPSON (800-463-7766).

Notices

Important Safety Instructions

Before using your Epson printer, read and follow these safety instructions:

- Be sure to follow all warnings and instructions marked on your Epson printer.
- Use only the type of power source indicated on the printer label.
- Use only the power cord that comes with the printer. Use of another cord may cause fires or shock. Do not use the cord with any other equipment.
- Place the printer near a wall outlet where the plug can be easily unplugged.
- If you won't be using the printer for a long period, unplug the power cord from the electrical outlet.
- Always turn off the printer using the  **Power** button, and wait until the  **Power** light stops flashing before unplugging the printer or cutting off power to the electrical outlet.
- Avoid plugging the printer into an outlet on the same circuit as a photo copier or air control system that regularly switches on and off, or on an outlet controlled by a wall switch or timer.
- Do not let the power cord become damaged or frayed.
- If you use an extension cord with the printer, make sure the total ampere rating of the devices plugged into the extension cord does not exceed the cord's ampere rating. Also, make sure the total ampere rating of all devices plugged into the wall outlet does not exceed the wall outlet's ampere rating.
- Avoid locations that are subject to rapid changes in heat or humidity, shocks or vibrations, or dust.
- Leave enough room around the printer for sufficient ventilation. Do not block or cover openings in the case or insert objects through the slots.
- Do not place the printer near a radiator or heating vent or in direct sunlight.
- Place the printer on a flat, stable surface that extends beyond its base in all directions. It will not operate properly if it is tilted or at an angle.
- Make sure the back of the printer is at least 4 inches (10 cm) away from the wall.
- Do not open the scanner section while the NX125/127 Series is copying, printing, or scanning.
- Do not spill liquid on the printer.

- Except as specifically explained in your documentation, do not attempt to service the printer yourself.
- Unplug the printer and refer servicing to qualified service personnel under the following conditions: if the power cord or plug is damaged; if liquid has entered the product; if the product has been dropped or the case damaged; if the product does not operate normally or exhibits a distinct change in performance. Adjust only those controls that are covered by the operating instructions.
- When storing or transporting the printer, do not tilt it, stand it on its side, or turn it upside down; otherwise ink may leak from the cartridges.
- Do not use aerosol products that contain flammable gases inside or around the printer. Doing so may cause fire.

Ink Cartridge Safety Instructions

- Keep ink cartridges out of the reach of children and do not drink the ink.
- Be careful when you handle used ink cartridges; there may be ink remaining around the ink supply port. If ink gets on your skin, wash it off with soap and water. If it gets in your eyes, flush them immediately with water.
- Do not shake ink cartridges after opening their packages; this can cause leakage.
- Do not put your hand inside the printer or touch any cartridges during printing.
- Install a new ink cartridge immediately after removing an expended one. Leaving cartridges uninstalled can dry out the print head and may prevent the printer from printing.
- If you remove an ink cartridge for later use, protect the ink supply area from dirt and dust and store it in the same environment as the printer. Note that there is a valve in the ink supply port, making covers or plugs unnecessary, but care is needed to prevent the ink from staining items that the cartridge touches. Do not touch the ink cartridge ink supply port or surrounding area.

FCC Compliance Statement

For United States Users

This equipment has been tested and found to comply with the limits for a Class B digital device, pursuant to Part 15 of the FCC Rules. These limits are designed to provide reasonable protection against harmful interference in a residential installation. This equipment generates, uses, and can radiate radio frequency energy and, if not installed and used in accordance with the instructions, may cause harmful interference to radio or television reception. However, there is no guarantee that interference will not occur in a particular installation. If this equipment does cause interference to radio and television reception, which can be determined by turning the equipment off and on, the user is encouraged to try to correct the interference by one or more of the following measures:

- Reorient or relocate the receiving antenna.
- Increase the separation between the equipment and receiver.
- Connect the equipment into an outlet on a circuit different from that to which the receiver is connected.
- Consult the dealer or an experienced radio/TV technician for help.

WARNING

The connection of a non-shielded equipment interface cable to this equipment will invalidate the FCC Certification of this device and may cause interference levels which exceed the limits established by the FCC for this equipment. It is the responsibility of the user to obtain and use a shielded equipment interface cable with this device. If this equipment has more than one interface connector, do not leave cables connected to unused interfaces. Changes or modifications not expressly approved by the manufacturer could void the user's authority to operate the equipment.

For Canadian Users

This Class B digital apparatus complies with Canadian ICES-003.

Cet appareil numérique de la classe B est conforme à la norme NMB-003 du Canada.

Declaration of Conformity

According to 47CFR, Part 2 and 15 for: Class B Personal Computers and Peripherals;
and/or CPU Boards and Power Supplies used with Class B Personal Computers:

We: Epson America, Inc.
Located at: MS 3-13
3840 Kilroy Airport Way
Long Beach, CA 90806
Telephone: (562) 290-5254

Declare under sole responsibility that the product identified herein, complies with 47CFR Part 2 and 15 of the FCC rules as a Class B digital device. Each product marketed is identical to the representative unit tested and found to be compliant with the standards. Records maintained continue to reflect the equipment being produced can be expected to be within the variation accepted, due to quantity production and testing on a statistical basis as required by 47CFR §2.909. Operation is subject to the following two conditions: (1) this device may not cause harmful interference, and (2) this device must accept any interference received, including interference that may cause undesired operation.

Trade Name: Epson
Type of Product: Multifunction printer
Model: C412A

Epson America, Inc. Limited Warranty

What Is Covered: Epson America, Inc. (“Epson”) warrants to the original retail purchaser that the Epson printer covered by this limited warranty statement, if purchased and operated only in the United States or Canada, will be free from defects in workmanship and materials for a period of one (1) year from the date of original purchase. For warranty service, you must provide proof of the date of original purchase.

What Epson Will Do To Correct Problems: Should your Epson printer prove defective during the warranty period, please call the Epson Connection at (562) 276-4382 (U.S.) or (905) 709-3839 (Canada) for warranty repair instructions and return authorization. An Epson service technician will provide telephone diagnostic service to determine whether the printer requires service. If service is needed, Epson will, at its option, exchange or repair the printer without charge for parts or labor. If Epson authorizes an exchange for the defective unit, Epson will ship a replacement printer to you, freight prepaid, so long as you use an address in Canada or the U.S. (excluding Puerto Rico and U.S. Possessions). Shipments to other locations will be made freight collect. You are responsible for securely packaging the defective unit and returning it to Epson within five (5) working days of receipt of the replacement. Epson requires a debit or a credit card number to secure the cost of the replacement printer in the event that you fail to return the defective one. If Epson authorizes repair instead of exchange, Epson will direct you to send your printer to Epson or its authorized service center, where the printer will be repaired and sent back to you. You are responsible for packing the printer and for all costs to and from the Epson authorized service center. When warranty service involves the exchange of the printer or a part, the item replaced becomes Epson property. The replacement printer or part may be new or refurbished to the Epson standard of quality, and, at Epson's option, may be another model of like kind and quality. Exchange products and parts assume the remaining warranty period of your original product covered by this limited warranty.

What This Warranty Does Not Cover: This warranty covers only normal use in the United States and Canada. Using this product for continuous production or similar high duty purposes is not considered normal use; damage, maintenance or service from such use will not be covered under this warranty. This warranty is not transferable. This warranty does not cover any color change or fading of prints or reimbursement of materials or services required for reprinting. This warranty does not cover damage to the Epson product caused by parts or supplies not manufactured, distributed or certified by Epson. This warranty does not cover ribbons, ink cartridges or third party parts, components, or peripheral devices added to the Epson product after its shipment from Epson, e.g., dealer or user-added boards or components. Epson is not responsible for warranty service should the Epson label or logo or the rating label or serial number be removed or should the product fail to be properly maintained or fail to function properly as a result of misuse, abuse, improper installation, neglect, improper shipping, damage caused by disasters such as fire, flood, and lightning, improper electrical current, software problems, interaction

with non-Epson products, or service other than by an Epson Authorized Servicer. If a claimed defect cannot be identified or reproduced, you will be held responsible for the costs incurred.

THE WARRANTY AND REMEDY PROVIDED ABOVE ARE EXCLUSIVE AND IN LIEU OF ALL OTHER EXPRESS OR IMPLIED WARRANTIES INCLUDING, BUT NOT LIMITED TO, THE IMPLIED WARRANTIES OF MERCHANTABILITY, NON-INFRINGEMENT OR FITNESS FOR A PARTICULAR PURPOSE. SOME LAWS DO NOT ALLOW THE EXCLUSION OF IMPLIED WARRANTIES. IF THESE LAWS APPLY, THEN ALL EXPRESS AND IMPLIED WARRANTIES ARE LIMITED TO THE WARRANTY PERIOD IDENTIFIED ABOVE. UNLESS STATED HEREIN, ANY STATEMENTS OR REPRESENTATIONS MADE BY ANY OTHER PERSON OR FIRM ARE VOID. IN NO EVENT SHALL EPSON OR ITS AFFILIATES BE LIABLE FOR ANY SPECIAL, INCIDENTAL OR CONSEQUENTIAL DAMAGES RESULTING FROM THE USE OR INABILITY TO USE THE EPSON PRODUCT, WHETHER RESULTING FROM BREACH OF WARRANTY OR ANY OTHER LEGAL THEORY. IN NO EVENT SHALL EPSON OR ITS AFFILIATES BE LIABLE FOR DAMAGES OF ANY KIND IN EXCESS OF THE ORIGINAL RETAIL PURCHASE PRICE OF THE PRODUCT.

In Canada, warranties include both warranties and conditions.

Some jurisdictions do not allow limitations on how long an implied warranty lasts, and some jurisdictions do not allow the exclusion or limitation of incidental or consequential damages, so the above limitations and exclusions may not apply to you. This warranty gives you specific legal rights and you may have other rights which vary from jurisdiction to jurisdiction.

To find the Epson Authorized Reseller nearest you, visit our website at:
<http://www.epson.com>.

To find the Epson Customer Care Center nearest you, visit
<http://www.epson.com/support>.

You can also write to:
Epson America, Inc., P.O. Box 93012, Long Beach, CA 90809-3012

Copyright Notice

All rights reserved. No part of this publication may be reproduced, stored in a retrieval system, or transmitted in any form or by any means, electronic, mechanical, photocopying, recording, or otherwise, without the prior written permission of Seiko Epson Corporation. The information contained herein is designed only for use with this Epson product. Epson is not responsible for any use of this information as applied to other equipment.

Neither Seiko Epson Corporation nor its affiliates shall be liable to the purchaser of this product or third parties for damages, losses, costs, or expenses incurred by purchaser or third parties as a result of: accident, misuse, or abuse of this product or unauthorized modifications, repairs, or alterations to this product, or (excluding the U.S.) failure to strictly comply with Seiko Epson Corporation's operating and maintenance instructions.

Seiko Epson Corporation shall not be liable for any damages or problems arising from the use of any options or any consumable products other than those designated as Original Epson Products or Epson Approved Products by Seiko Epson Corporation.

In addition to software program rights owned by Seiko Epson Corporation, this product also includes open source software. Refer to OSS.pdf on your Printer Software CD-ROM for a list of open source software and software license terms applied to this printer.

Responsible Use of Copyrighted Materials

Epson encourages each user to be responsible and respectful of the copyright laws when using any Epson product. While some countries' laws permit limited copying or reuse of copyrighted material in certain circumstances, those circumstances may not be as broad as some people assume. Contact your legal advisor for any questions regarding copyright law.

Trademarks

Epson and Epson Stylus are registered trademarks, Epson Exceed Your Vision is a registered logomark, and Supplies Central is a service mark of Seiko Epson Corporation.

Epson Connection is a service mark of Epson America, Inc.

General Notice: Other product names used herein are for identification purposes only and may be trademarks of their respective owners. Epson disclaims any and all rights in those marks.

This information is subject to change without notice.

© 2010 Epson America, Inc. 4/10



EPSON®
EXCEED YOUR VISION



411907500

CPD-27883R1
Printed in XXXXXX