

# Operating and installation instructions

## Oven

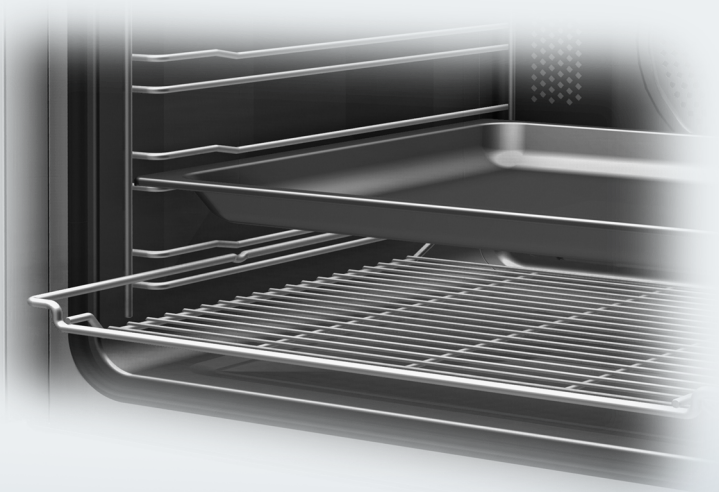

To avoid the risk of accidents or damage to the appliance it is **essential** to read these instructions before it is installed and used for the first time.



<b>Warning and Safety instructions</b> . . . . .	6
<b>Caring for the environment</b> . . . . .	18
<b>Oven overview</b> . . . . .	19
<b>Oven controls</b> . . . . .	20
Function selector . . . . .	20
Functions: . . . . .	20
Clock/timer . . . . .	21
Display . . . . .	21
Buttons . . . . .	21
Temperature selector . . . . .	21
Temperature indicator light  . . . . .	21
<b>Features</b> . . . . .	22
Model numbers . . . . .	22
Data plate . . . . .	22
Items supplied . . . . .	22
Accessories supplied and available to order . . . . .	22
Shelf runners . . . . .	23
Baking tray, universal tray and rack with non-tip notches . . . . .	23
FlexiClip telescopic runners HFC 70 . . . . .	24
Fitting and removing FlexiClip telescopic runners . . . . .	24
Oven controls . . . . .	28
Safety features . . . . .	28
System lock  for the oven . . . . .	28
Cooling fan . . . . .	28
Vented oven door . . . . .	28
PerfectClean treated surfaces . . . . .	29
Catalytic enamelled surfaces . . . . .	29
<b>Using for the first time</b> . . . . .	30
Before using for the first time . . . . .	30
Setting the time of day for the first time . . . . .	30
Heating up the oven for the first time . . . . .	31
<b>Overview of functions</b> . . . . .	32
<b>Operation</b> . . . . .	34
Tips on saving energy . . . . .	34
Residual heat use . . . . .	34
Using the oven . . . . .	34
Cooling fan . . . . .	34

# Contents

---

Pre-heating	35
<b>Clock/timer</b>	36
Display	36
Symbols in the display	36
Buttons	36
How to set the time or a duration	37
Displaying times/durations	37
When the time/duration has elapsed	37
Using the minute minder 	38
To set the minute minder	38
To change the time set for the minute minder	39
To cancel the time set for the minute minder	39
Switching on and off automatically	40
Setting a cooking duration	40
At the end of the cooking duration	41
Setting a cooking duration and finish time	42
Altering the cooking duration	43
Deleting a cooking duration	44
Deleting a finish time	44
Altering the time of day	45
Altering settings	46
<b>Baking</b>	48
Notes on the baking chart	49
Baking chart	50
<b>Roasting</b>	54
Notes on the roasting chart	54
Roasting chart	56
<b>Low temperature cooking</b>	58
<b>Grilling</b>	60
Notes on the grilling chart	61
Grilling chart	63
<b>Defrosting</b>	64
<b>Drying food</b>	65
<b>Frozen food/Ready meals</b>	66
<b>Gentle bake</b>	67

<b>Note for test institutes</b> . . . . .	68
Test food acc. to EN 60350 . . . . .	68
Energy rating . . . . .	68
<b>Cleaning and care</b> . . . . .	69
Unsuitable cleaning agents . . . . .	69
Tips . . . . .	70
Normal soiling . . . . .	70
Cleaning the seal . . . . .	70
Stubborn soiling on the FlexiClip runners . . . . .	71
Cleaning the catalytic enamelled back panel . . . . .	71
Removing spice, sugar and similar deposits . . . . .	71
Removing oil and grease splashes . . . . .	72
Removing the door . . . . .	73
Dismantling the door . . . . .	74
Refitting the door . . . . .	77
Removing the side runners with FlexiClip runners . . . . .	78
Removing the back panel . . . . .	79
Lowering the top heat/grill element . . . . .	79
<b>Problem solving guide</b> . . . . .	80
<b>After Sales / Guarantee</b> . . . . .	84
<b>Electrical connection</b> . . . . .	85
<b>Building-in diagrams</b> . . . . .	87
Appliance and niche dimensions . . . . .	87
Front dimensions . . . . .	89
<b>Installing the oven</b> . . . . .	90
<b>Addresses</b> . . . . .	91

## Warning and Safety instructions

---

This appliance complies with statutory safety requirements. Inappropriate use can, however, lead to personal injury and damage to property.

To avoid the risk of accidents and damage to the appliance, please read these instructions carefully before using it for the first time. They contain important notes on installation, safety, use and maintenance.

Miele cannot be held liable for non-compliance with these instructions.

Keep these instructions in a safe place and ensure that new users are familiar with the contents. Pass them on to any future owner.

## Correct application

- ▶ This oven is intended for use in domestic households and similar working and residential environments.
- ▶ The oven is not intended for outdoor use.
- ▶ It is intended for domestic use only to cook food, and in particular to bake, roast, grill, cook, defrost and dry food. Any other use is not supported by the manufacturer and could be dangerous.
- ▶ People with reduced physical, sensory or mental capabilities, or lack of experience or knowledge who are not able to use the appliance safely on their own must be supervised whilst using it. They may only use it unsupervised if they have been shown how to use it safely and recognise and understand the consequences of incorrect operation.

# Warning and Safety instructions

---

## Safety with children

- ▶ Children under 8 years of age must be kept away from the appliance unless they are constantly supervised.
- ▶ Children 8 years and older may only use the oven unsupervised if they have been shown how to use it safely and recognise and understand the consequences of incorrect operation.
- ▶ Children must not be allowed to clean or maintain the appliance unsupervised.
- ▶ Please supervise children in the vicinity of the oven and do not let them play with it.
- ▶ Danger of suffocation. Packaging, e.g. plastic wrappings, must be kept out of the reach of babies and children. Whilst playing, children could become entangled in packaging or pull it over their head and suffocate.



## Warning and Safety instructions

---

▶ Danger of burning.

Children's skin is far more sensitive to high temperatures than that of adults. External parts of the oven such as the door glass, control panel and the vents become quite hot during use. Do not let children touch the oven whilst it is in use.

▶ Danger of injury.

The oven door can support a maximum weight of 15 kg. Do not let children sit on the door, lean against it or swing on it.

# Warning and Safety instructions

---

## Technical safety

- ▶ Unauthorised installation, maintenance and repairs can cause considerable danger for the user. Installation, maintenance and repairs must only be carried out by a Miele authorised technician.
- ▶ Never use a damaged oven. It could be dangerous. Check it for visible signs of damage before using it.
- ▶ Reliable and safe operation of this oven can only be assured if it has been connected to the mains electricity supply.
- ▶ The electrical safety of this appliance can only be guaranteed when correctly earthed. It is essential that this standard safety requirement is met. If in any doubt please have the electrical installation tested by a qualified electrician.
- ▶ To avoid the risk of damage to the oven, make sure that the connection data on the data plate (voltage and frequency) match the mains electricity supply before connecting the oven to the mains. Consult a qualified electrician if in doubt.
- ▶ Do not connect the appliance to the mains electricity supply by a multi-socket unit or an extension lead. These do not guarantee the required safety of the appliance (fire hazard).
- ▶ For safety reasons, this appliance may only be used after it has been built in.
- ▶ The oven must not be used in a non-stationary location (e.g. on a ship).

## Warning and Safety instructions

---

- ▶ Tampering with electrical connections or components and mechanical parts is highly dangerous to the user and can cause operational faults.  
Never open the casing of the appliance.
- ▶ While the appliance is under guarantee, repairs should only be undertaken by a Miele authorised service technician. Otherwise the guarantee is invalidated.
- ▶ Miele can only guarantee the safety of the appliance when genuine original Miele replacement parts are used. Faulty components must only be replaced by Miele spare parts.
- ▶ If the connection cable is damaged or if the oven is supplied without a cable, it must be replaced or fitted with a special connection cable by a Miele authorised technician (see "Electrical connection").
- ▶ During installation, maintenance and repair work, the appliance must be disconnected from the mains electricity supply, e.g. if the oven lighting is faulty (see "Problem solving guide" and "Electrical connection").

## Warning and Safety instructions

---

▶ In order to function correctly, the oven requires an adequate supply of cool air. Ensure that the supply of cool air is not impaired (e.g. by heat insulation strips in the housing unit). Please also ensure that the cool air supply is not unduly heated by other heat sources such as a solid fuel stove.

▶ If the oven is installed behind a furniture panel (e.g. a door), ensure that the door is never closed whilst the oven is in use. Heat and moisture can build up behind a closed furniture panel and cause subsequent damage to the oven, the housing unit and the floor. Do not close the door until the oven has cooled down completely.

## Correct use

 Danger of burning.

The oven becomes hot when in use.

You could burn yourself on the heating elements, oven interior, cooked food or oven accessories.

Wear oven gloves when placing food in the oven, turning or removing it and when adjusting oven shelves etc. in a hot oven.

▶ Due to the high temperatures radiated, objects left near the oven when it is in use could catch fire.

Do not use the oven to heat up the room.

▶ Oil and fat can ignite if overheated. Never leave the oven unattended when cooking with oil and fat.



If it does ignite do not put the flames out with water. Switch the oven off immediately and then suffocate the flames by keeping the oven door closed.

▶ Grilling food for an excessively long time can cause it to dry out with the risk of catching fire.

Do not exceed recommended grilling times.

## Warning and Safety instructions

---

▶ Some types of food dry out quickly and can self-ignite if high grill temperatures are used. Never use the grill to finish baking part-cooked rolls or bread or to dry flowers or herbs. Use Fan plus  or Conventional heat  for this type of procedure.

▶ If using alcohol in your recipes, please be aware that high temperatures can cause the alcohol to vaporise. The vapour can catch fire on hot heating elements.

▶ When using residual heat to keep food in the oven warm, the high moisture content and amount of condensation in the oven can cause corrosion damage. The control panel, the worktop or the housing unit can also suffer damage.

When using residual heat do not switch the oven off. Instead set the temperature to the lowest setting and leave the oven on the selected function. The fan will then remain on automatically and dissipate the moisture.

▶ Food which is stored in the oven or left in it to be kept hot can dry out and the moisture released can lead to corrosion damage in the oven. Always cover food that is left in the oven to keep warm.

▶ A build-up of heat can cause the enamel on the floor of the oven to crack or shatter.

Do not line the floor of the oven with anything, e.g. aluminium foil. Do not place roasting pans, pots or baking trays directly on the oven floor.

▶ The enamelling on the oven floor can become damaged by items being pushed around on it. If using the oven to store pots and pans, ensure that you avoid pushing them around on the oven floor.

## Warning and Safety instructions

---

▶ If cold liquid is poured onto a hot surface steam will occur, which can cause scalding. The sudden change in temperature can also damage enamel surfaces.

Do not pour cold liquid directly onto hot enamelled surfaces.

▶ It is important that the temperature in the food being cooked is evenly distributed and sufficiently high. Stir and / or turn it to ensure even heat distribution.

▶ Plastic containers which are not suitable for use in an oven can melt at high temperatures and can even damage the oven or catch fire.

Only use plastic containers which are declared by the manufacturer as being suitable for use in an oven. Follow the manufacturer's instructions on use.

▶ Do not bottle or heat up food in closed containers e.g. tins or sealed jars in the oven, as pressure will build up in the container, causing it to explode.

▶ You could injure yourself on the open oven door or trip over it. Avoid leaving the door open unnecessarily.

▶ The door can support a maximum weight of 15 kg. Do not sit on or lean against an open door, and do not place heavy objects on it. Also make sure that nothing can get trapped between the door and the oven cavity. The oven could get damaged.

# Warning and Safety instructions

---

## Cleaning and care

- ▶ Do not use a steam cleaning appliance to clean this appliance. The steam could reach electrical components and cause a short circuit.
- ▶ Scratches on the door glass can result in the glass breaking. Do not use abrasive cleaners, hard sponges, brushes or sharp metal tools to clean the door glass.
- ▶ The side runners can be removed for cleaning purposes (see "Cleaning and care"). Ensure that they are replaced correctly and do not use the oven without them fitted.
- ▶ The catalytic enamelled back panel can be removed for cleaning purposes (see "Cleaning and care"). Ensure that the back panel is replaced correctly and do not use the oven without it fitted.



## Accessories

▶ Only use genuine original Miele accessories and spare parts with this appliance. Using accessories or spare parts from other manufacturers will invalidate the guarantee, and Miele cannot accept liability.

▶ If you have a Miele HUB 5000-M, HUB 5001-M or a HUB 5000-XL oven dish, do not place it on Shelf level 1. This would damage the floor of the oven. The very small gap between the bottom of the dish and the oven floor would cause a build-up of heat and could cause the enamel to crack or chip. Never place a Miele oven dish on the top rail of Shelf level 1 as it will not be held securely in this position by the anti-tip notches on the runners.  
In general it is best to use Shelf level 2.

# Caring for the environment

---

## Disposal of the packing material

The packaging is designed to protect the appliance from damage during transportation. The packaging materials used are selected from materials which are environmentally friendly for disposal and should be recycled.

Recycling the packaging reduces the use of raw materials in the manufacturing process and also reduces the amount of waste in landfill sites.

## Disposing of your old appliance

Electrical and electronic appliances often contain valuable materials. They also contain materials which, if handled or disposed of incorrectly, could be potentially hazardous to human health and to the environment. They are, however, essential for the correct functioning of your appliance. Please do not therefore dispose of it with your household waste.

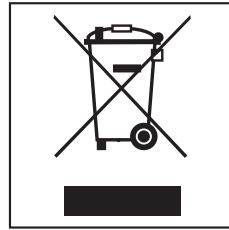

Please dispose of it at your local community waste collection / recycling centre or contact your Dealer for advice.

Ensure that it presents no danger to children while being stored for disposal.

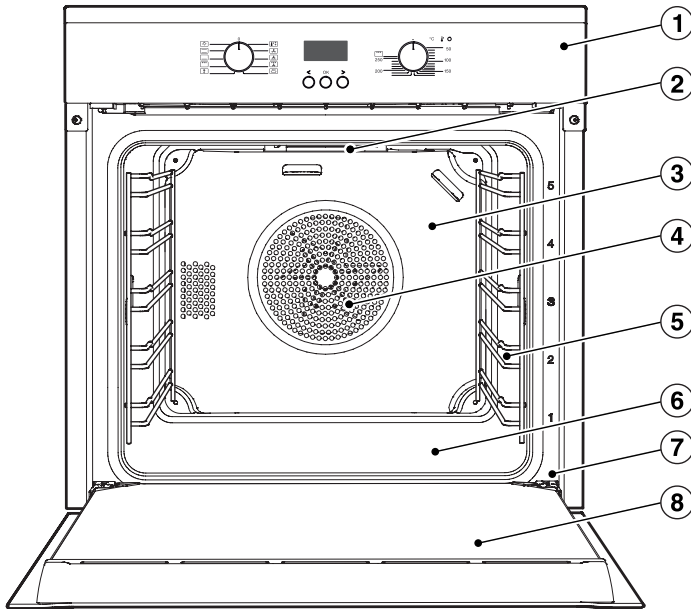

- ① Oven controls\*
- ② Top heat/grill element
- ③ Catalytic enamelled back panel
- ④ Air inlet for the fan with ring heating element behind it
- ⑤ Side runners with 5 shelf levels
- ⑥ Oven floor with bottom heat element underneath it
- ⑦ Front frame with data plate
- ⑧ Door

\* depending on model

# Oven controls

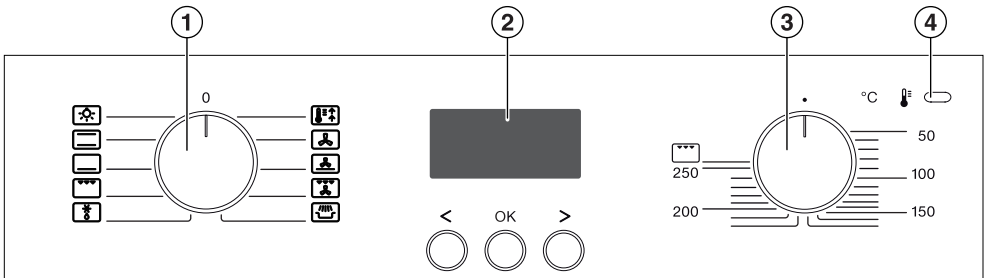

- ① Function selector
- ② Clock/timer
- ③ Temperature selector
- ④ Temperature indicator light

## Function selector

Use the function selector to select the required function and switch on the oven lighting independently.

It can be turned clockwise or anti-clockwise.

In the **0** position it can be retracted by pressing it in.

## Functions:

-  Lighting
-  Conventional heat
-  Bottom heat
-  Grill
-  Defrost
-  Rapid heat-up
-  Fan plus
-  Intensive bake
-  Fan grill
-  Gentle bake

## Clock/timer

(depending on model)

The clock/timer is operated via the **display** and the <, OK and > **buttons**.

## Display

The display shows the time of day or your settings.

It goes dark if settings are not being entered.

Please refer to "Clock/Timer" for more information.

## Buttons

The H266xB has sensor controls which react to finger touch. Each touch is confirmed with a keypad tone. This keypad tone can be switched off if wished. Go to setting **P 4** and select status **5 1** (see "Clock/timer – Altering settings").

All the other models have push buttons.

## Temperature selector

Use the temperature selector to select the temperature for the cooking processes.

It can be turned clockwise until a resistance is felt and then back again. The temperature selector can be retracted when it is in the ● position by pressing it in.

The temperature settings are marked on the temperature selector and on the control panel.

## Temperature indicator light

The temperature indicator light  lights up whenever the oven heating is switched on.

As soon as the set temperature is reached,

- the oven heating switches off
- and the temperature indicator light goes out.

The temperature control unit ensures that the oven heating and the temperature indicator light switch back on if the temperature in the oven falls below the level set.

# Features

---

## Model numbers

Please see the back page of this booklet for a list of the H2x6xB ovens to which these operating and installation instructions refer.

## Data plate

The data plate is located on the front frame, visible when the door is open.

The data plate states the model number of your oven, the serial number as well as connection data (voltage, frequency and maximum connected load).

Please have this information to hand, should you need to contact Miele regarding any questions or problems.

## Items supplied

The oven is supplied with:

- the operating and installation instructions for using the oven,
- screws for securing your oven in the housing unit,
- various accessories.

## Accessories supplied and available to order

Accessories will vary depending on model.

Your oven will be supplied with side runners, a universal tray and a rack. Depending on model, your oven may also come supplied with some or several of the accessories listed here.

All the accessories listed as well as the cleaning and care products are designed for Miele appliances.

These can be ordered via the internet at [www.miele-shop.com](http://www.miele-shop.com), from Miele (see back cover for contact details) or from your Miele dealer.

When ordering, please quote the model number of your oven and give a description of the accessories required.

## Shelf runners

Side runners for trays, racks and accessory dishes are fitted on either side of the oven cavity for shelf levels



The numbers for the shelf levels are marked on the front frame.

Each level consists of two rails, one above the other.

- The accessories (e.g. the rack) are pushed into the oven between the rails,
- FlexiClip telescopic runners (depending on model) are fitted on the lower rail.

If necessary, the side runners can be removed for cleaning (see "Cleaning and care").

## Baking tray, universal tray and rack with non-tip notches

Baking tray HBB 71:

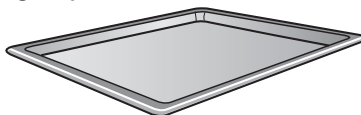

Universal tray HUBB 71:

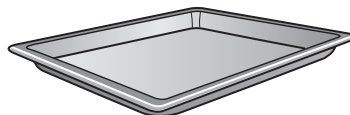

Rack HBBR 71:

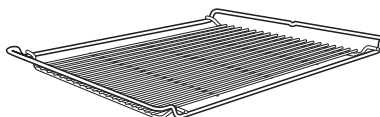

These accessories are inserted into the oven between the two rails of a side runner.

Always position the rack as illustrated above.

The accessories have non-tip safety notches half way along the short edges which prevent them from being pulled right out when they only need to be pulled partially out.



If you are using the universal tray with the rack on top, insert the tray between the rails of the side runners and the rack will automatically slide in above them.

The enamelled surfaces have been treated with PerfectClean.

# Features

## FlexiClip telescopic runners HFC 70

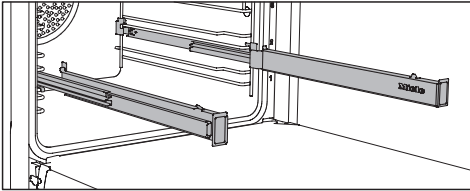

The FlexiClip telescopic runners can be used with any shelf level.

Push the FlexiClip telescopic runners right into the oven before placing accessories on them. The accessories will then automatically sit securely in between the stoppers at either end of each runner and be prevented from sliding off.

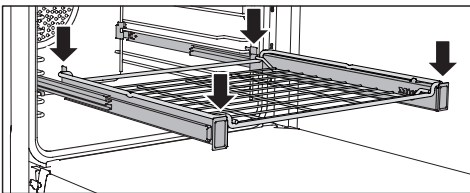
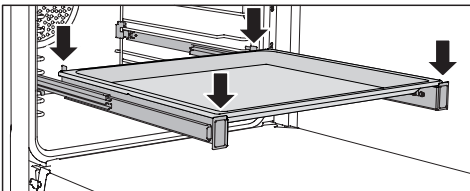

The FlexiClip runners can support a maximum load of 15 kg.

## Fitting and removing FlexiClip telescopic runners

 Danger of burning.  
Make sure the oven heating elements are switched off and cool.

The FlexiClip runners are fitted in between the two rails that make up a shelf level.

The FlexiClip runner with the Miele logo is fitted on the right.

When fitting the FlexiClip telescopic runners **do not** extend them.

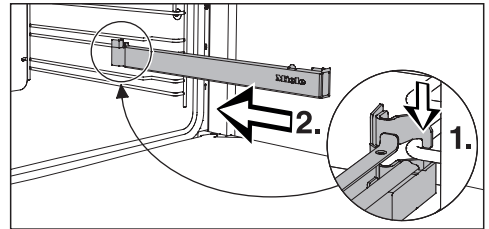

- Hook the FlexiClip runner onto the front of the lower rail of a side rail (1.) and then push it along the rail into the oven compartment (2.).



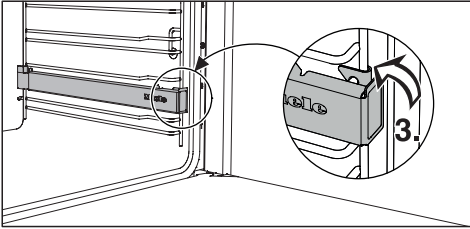

- Then secure the FlexiClip runner to the bottom of the two rails as illustrated (3).

If the FlexiClip runners are difficult to pull out after fitting, you may need to pull firmly on them once to release them.

To remove a FlexiClip runner:

- Push the FlexiClip runner in all the way.

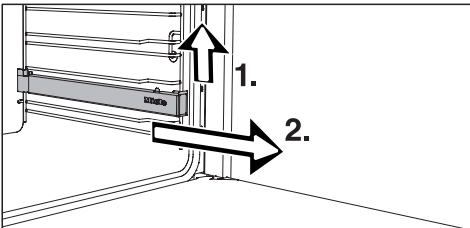

- Remove the FlexiClip runner by raising it at the front (1.) then pulling it forwards along the rail and out (2).

## Gourmet baking tray, perforated HBBL 71

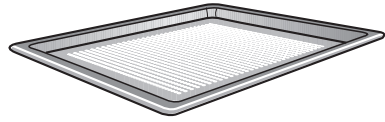

The perforated gourmet oven tray has been specially designed for baking fresh yeast and quark dough items, bread and rolls.

The fine perforations help to brown the underside of food.

The tray can also be used for drying fruit and vegetables.

The enamelled surface has been treated with PerfectClean.

## Anti-splash insert HGBB 71

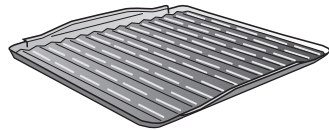

The anti-splash insert fits in the universal tray.

The juices from the food being grilled or roasted collect under the insert. This prevents them from spitting and making the oven dirty. The juices can then be used for making gravy and sauces.

The enamelled surface has been treated with PerfectClean.

# Features

---

## Round baking tray HBF 27-1

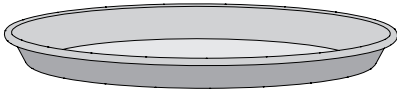

The round baking tray is suitable for cooking pizza, shallow cakes made with yeast or whisked mixtures, sweet and savoury tarts, baked desserts, flat bread, and can also be used for frozen cakes and pizzas.

The enamelled surface has been treated with PerfectClean.

## Baking stone HBS 60

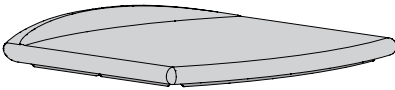

The baking stone is ideal for items which need a well baked base such as pizza, quiche, bread, bread rolls and savoury snacks.

The baking stone is made from heat retaining fire brick and is glazed. Place it directly on the rack.

A paddle made of untreated wood is supplied with it for placing food on the baking stone and taking it off.

## HUB oven dish and HBD oven dish lid

The Miele oven dish, unlike other oven dishes, slides into the oven on the side rails. It has non-tip safety notches like the universal tray to prevent it being pulled out too far. It also has a non-stick coating.

The Miele oven dishes are either 22 cm or 35 cm deep. The width and height are the same.

Lids are also available. These are ordered separately.

Please quote the model number of your Miele oven dish when ordering.

### Depth: 22 cm

HUB 5000-M  
HUB 5001-M\*



HBD 60-22

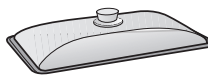

### Depth: 35 cm

HUB 5000-XL

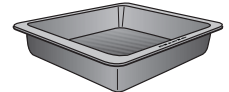

HBD 60-35

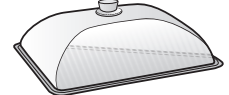

\* suitable for use on induction hobs

## Handle HEG

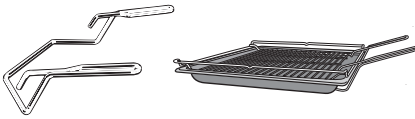

The handle makes it easier to take the universal tray, baking tray and rack out of the oven, or to put them into it. The two prongs at the top go inside the tray or above the rack, and the U-shape supports underneath.

## Catalytic enamelled liners

- Side liners  
These are fitted behind the side rails in the sides of the oven and help keep the oven walls clean.
- Roof liner  
This is fitted above the top heat/grill element and helps keep the roof of the oven clean.
- Back panel  
This should be replaced if the catalytic enamel has become ineffective due to incorrect use or very heavy soiling.

When ordering, please quote the model number of your oven.

## Miele microfibre cloth

Light soiling and fingerprints can be easily removed with the microfibre cloth.

## Miele oven cleaner

Miele oven cleaner is suitable for removing very stubborn soiling. It is not necessary to pre-heat the oven beforehand.

# Features

---

## Oven controls

(features will vary depending on model)

The oven controls are used to operate the various cooking functions for baking, roasting and grilling.

Ovens with a clock/timer also offer the following:

- a time of day display,
- a minute minder,
- a timer to automatically switch cooking programmes on and off,
- settings that can be customised.

## Safety features

### System lock for the oven

The system lock prevents the oven from being used unintentionally (see "Clock/timer - Changing settings – P 3").

When the system lock is engaged  will appear in the display.

## Cooling fan

A cooling fan will come on automatically when a cooking programme is started. The cooling fan mixes hot air from the oven cavity with cool room air before venting it out into the kitchen through vents located between the appliance door and the control panel.

The cooling fan will continue to run for a while after a programme to prevent moisture building up in the oven, on the control panel or in the oven housing unit.

When the temperature in the oven has fallen sufficiently, the cooling fan will switch off automatically.

## Vented oven door

The oven door glass panes have a heat-reflecting coating.

When the oven is operating, air is passed through the door to keep the outer pane cool.

The door can be removed and dismantled for cleaning (see "Cleaning and care").

## PerfectClean treated surfaces

PerfectClean surfaces have very good non-stick properties and are much easier to keep clean than conventional enamel surfaces, if cleaned regularly.

Food can be taken off it easily, and soiling from baking and roasting is simple to remove.

Food can be sliced or cut up on PerfectClean surfaces.

However, do not use ceramic knives as these will scratch the PerfectClean surface.

Surfaces treated with PerfectClean enamel can be cleaned as you would clean glass.

Read the instructions in "Cleaning and care" so that the benefits of the non-stick properties and easy cleaning are retained.

The following have all been treated with PerfectClean:

- Oven interior
- Universal tray
- Baking tray
- Anti-splash insert
- Gourmet baking tray, perforated
- Round baking tray

## Catalytic enamelled surfaces

The back panel is coated with catalytic enamel. Soiling from oil and fat is burnt off this surface when very high temperatures are used in the oven.

See "Cleaning and care" for more information.

## Using for the first time

### Before using for the first time

 The oven must not be operated until it has been correctly installed in its housing unit.

- Press and release the function and temperature selectors if they are retracted.

The time of day can only be changed when the function selector is at **0**.

- On models with a clock/timer, enter the correct time of day.

### Setting the time of day for the first time

The time of day is shown in 24 hour clock format.



After connecting the oven to the electricity supply, *12:00* will flash in the display.

The time of day is set in segments: first the hours, then the minutes.

- Press OK.

*12:00* will light up constantly and ⊕ will flash.

- Whilst ⊕ is flashing, press OK.

The hours will flash.

- Use < or > to set the hours.

- Press OK.

The hours are saved and the minutes will flash.

- Use < or > to set the minutes.

- Press OK.

The time of day is now saved.

The time of day can be displayed in 12 hour format by setting *P 2* in the settings menu to status *12* (see "Clock/timer – Changing settings").

### Heating up the oven for the first time

New ovens can give off an unpleasant smell on first use. Heating up the oven for at least 1 hour with nothing in it will get rid of this smell.

Ensure that the kitchen is well ventilated during this operation. Close doors to other rooms to prevent the smell spreading throughout the house.

- Remove any stickers or protective foil from the oven and accessories.
- Take the accessories out of the oven and clean them (see "Cleaning and care").
- Before heating the oven up, wipe the interior with a damp cloth to remove any dust or bits of packaging that may have accumulated in the oven cavity during storage and unpacking.
- Select Fan plus .

The oven heating, lighting and cooling fan will switch on.

- Set the maximum temperature (250 °C).
- Heat the empty oven for at least an hour.
- After the heating up process has finished, turn the function selector to **0** and the temperature selector to **●**.

 Danger of burning.  
Allow the oven to cool down before cleaning by hand.

- Clean the oven interior with a clean sponge and a solution of hot water and washing-up liquid or a clean damp microfibre cloth.
- Dry all surfaces with a soft cloth.

Leave the oven door open until the oven interior is completely dry.

# Overview of functions

---

Your oven has a range of oven functions for preparing food.

Depending on the function selected, different heating elements are switched on and sometimes combined with the fan (see details in brackets).

## Conventional heat

(Top heat/grill element + bottom heat element)

For baking and roasting traditional recipes, preparing soufflés and cooking at low temperatures.

If using an older recipe or cookbook, set the oven temperature for Conventional heat 10 °C lower than that recommended. This will not change cooking times.

## Bottom heat

(Bottom heat element)

Use this setting towards the end of cooking to brown the base of a cake, quiche or pizza.

## Grill

(Top heat/grill element)

For grilling larger quantities of thin cuts (e.g. steaks) and browning baked dishes.

## Defrost

(Fan)

For the gentle defrosting of frozen food.



## Rapid heat-up

(Top heat/grill element + ring heat element + fan)

For pre-heating the oven quickly. The oven function required must then be selected.

## Fan plus

(Ring heat element + fan)

This function is used for baking and roasting on different levels at the same time.

A lower temperature can be selected than when using Conventional heat , as the fan distributes the heat to the food straight away.

## Intensive bake

(Ring heat element + fan + bottom heat element)

For baking cakes with moist toppings. Intensive bake is not suitable for baking thin biscuits or for roasting as the juices will become too dark.

## Fan grill

(Top heat/grill element + fan)

For grilling thicker cuts of meat (e. g. roulades, chicken). Lower temperatures can be used than when using the Grill  function, as the fan distributes the heat to the food straight away.

## Gentle bake



(Top heat/grill element + ring heat element + fan)

Ideal for cooking bakes and gratins that need to be crispy on top.

# Operation

---

## Tips on saving energy

- Remove any accessories from the oven that you do not require for cooking.
- Pre-heat the oven only if instructed to do so in the recipe or the cooking chart.
- Avoid opening the door during cooking.
- In general, if a range of temperatures is given, it is best to select the lower temperature and to check the food after the shortest given time.
- Use Fan plus  as you can cook at temperatures 10–30 °C lower than when using other functions.
- Fan grill  can be used for a wide variety of food. With Fan grill you can use lower temperatures than with other grill functions which use the maximum temperature setting.

## Residual heat use

When cooking using temperatures above 140 °C and cooking durations longer than 30 minutes you can turn the temperature selector down to ● about 5 minutes before the end of cooking. The heating elements will switch off and the residual heat in the oven will be sufficient to finish cooking the food.

## Using the oven

- Place the food in the oven.
- Select the required oven function with the function selector.

The oven lighting and the fan will switch on.

- Use the temperature selector to set the temperature.

The oven heating will switch on.

After cooking:

- Turn the function selector to 0 and the temperature selector to ●.
- Take the food out of the oven.

## Cooling fan

The cooling fan will continue to run for a while after a cooking process to prevent moisture building up in the oven, on the control panel or on the oven housing unit.

The cooling fan will switch off automatically when the temperature in the oven interior has fallen sufficiently.

## Pre-heating

It is only necessary to pre-heat the oven in a few instances.

Most dishes can be placed in a cold oven. They will then make use of the heat produced during the heating-up phase.

Pre-heat the oven when cooking the following food with the following oven functions:

### Fan plus



- dark bread dough,
- beef sirloin joints and fillet.

### Conventional heat

- cakes and biscuits with a short baking time (up to 30 minutes)
- delicate mixtures (e.g. sponges)
- dark bread dough,
- beef sirloin joints and fillet.

## Rapid heat-up

Do not use Rapid heat-up  to pre-heat the oven when baking pizzas or biscuits and small cakes. They will brown too quickly on top.

- Select Rapid heat-up .
- Select a temperature.
- When the temperature indicator light  goes out for the first time, set the oven function you require for continued cooking.
- Place the food in the oven.

# Clock/timer

(features will vary depending on model)

The clock/timer can:

- display the time of day,
- be used as a minute minder,
- switch cooking processes on and off automatically,
- be used to alter various settings *P*.

The clock/timer is operated via the **display** and the <, OK and > **buttons** .

The functions available are indicated by symbols.

## Display

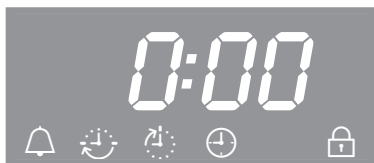

## Symbols in the display

Depending on the position of the function selector  $\bigcirc$  and/or whether a button has been pressed, the following symbols appear:

Symbol/function	$\bigcirc$
Minute minder	Any
Duration	Function
End of cooking duration	
Time of day	<b>0</b>
<i>P</i> Setting	
<i>S</i> Setting status	
System lock	

You can only set or change a function if the function selector is in the correct position.

## Buttons

Button	Use
<	<ul style="list-style-type: none"> <li>– To highlight a function</li> <li>– To reduce a duration</li> <li>– To call up settings <i>P</i></li> <li>– To change the status <i>S</i> of a setting <i>P</i></li> </ul>
>	<ul style="list-style-type: none"> <li>– To highlight a function</li> <li>– To increase a duration</li> <li>– To change the status <i>S</i> of a setting <i>P</i></li> </ul>
OK	<ul style="list-style-type: none"> <li>– To confirm a function</li> <li>– To save set durations and altered settings</li> <li>– To confirm set durations</li> </ul>

Hours, minutes or seconds are set with the < or > buttons in individual steps. Holding the button pressed will speed up the change in the display.

## How to set the time or a duration

Times are set in segments:

- For the time of day and cooking durations, first the hours, then the minutes.
- For the minute minder, first the minutes, then the seconds.

■ Press OK.

Depending on the position of the function selector, the functions (⏰, ⏱, ⏲ or ⏳) will appear.

■ Highlight the function required with < or >.

The appropriate symbol will flash for about 15 seconds.

■ Press OK while the symbol is flashing.

This selects the function and the left numeric block will start to flash.

You can only set the time/duration while the numeric block is flashing. If you run out of time you will have to select the function again.

■ Use < or > to enter the value required.

■ Press OK.

The right numeric block will start to flash.

■ Use < or > to enter the value required.

■ Press OK.

The time/duration you have set is now saved.

## Displaying times/durations

If times/durations have been entered, the ⏰ and ⏱ or ⏲ symbols will appear to show that these have been set.

If you are using the minute minder ⏰, cooking duration ⏱ and end of cooking time ⏲ functions simultaneously, the last selected time will be displayed.

If you have selected a cooking duration, the time of day cannot be displayed.

## When the time/duration has elapsed

- the relevant symbol will flash,
- a buzzer will sound, if this option is selected (see "Clock/timer - Altering settings").

■ Press OK.

The buzzer will stop and the symbols in the display will go out.

# Clock/timer

## Using the minute minder

The minute minder can be used to time other activities in the kitchen, e.g. boiling eggs.

The minute minder can also be used at the same time as a cooking programme in which the start and finish times have been set, e.g. as a reminder to stir a dish or add seasoning etc.

A maximum minute minder time of 99 minutes and 59 seconds can be set.

### To set the minute minder

Example: You want to boil some eggs and set a minute minder time of 6 minutes and 20 seconds.

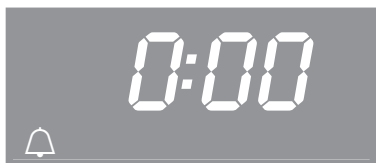

■ Press < repeatedly until  starts flashing.

■ Press OK.



00:00 will appear and the minutes block will flash.

If you then press < once, two lines will appear and, after pressing again, the maximum possible minute value 99 will appear.



■ Use < or > to set the minutes.

■ Press OK.

The minutes are saved and the seconds will flash.



■ Use < or > to enter the seconds.

■ Press OK.

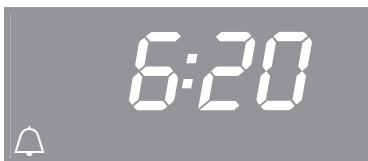

The minute minder is saved and will count down in seconds.

The  symbol indicates the minute minder has been set.

## At the end of the minute minder time

- 🔔 will flash,
- the display will show the time counting upwards.
- a buzzer will sound for approx. 7 minutes, if this option is selected (see "Clock timer - Altering settings").

- Press OK.

The buzzer will stop and the symbols in the display will go out.

If cooking durations have not been set, the time of day will appear in the display.

## To change the time set for the minute minder

- Press < repeatedly until 🔔 starts flashing.

The minute minder time selected appears.

- Press OK.

The minutes block will flash.

- Use < or > to set the minutes.

- Press OK.

The seconds block will flash.

- Use < or > to enter the seconds.

- Press OK.

The changed minute minder is saved and will count down in seconds.

## To cancel the time set for the minute minder

- Press < repeatedly until 🔔 starts flashing.

- Press OK.

The minutes block will flash.

- Decrease the minutes to **00** by pressing <, or increase them to **99** by pressing >.

The next time the relevant button is pressed, two lines will appear instead of the minutes:

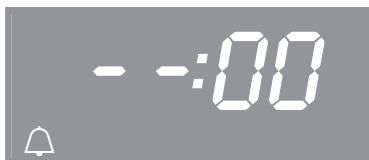

- Press OK.

Four lines will appear:



- Press OK.

The minute minder is now cancelled.

If cooking durations have not been set, the time of day will appear in the display.

# Clock/timer

## Switching on and off automatically

Cooking programmes can be switched off, or on and off automatically.

To do this, set a duration or a duration and finish time after selecting an oven function and a temperature.

The maximum duration which can be set for a cooking programme is 11 hours and 59 minutes.

We recommend switching on and off automatically when roasting.

If using it for baking, do not delay the start for too long as the cake mixture or dough will dry out, and the raising agents will lose their effectiveness.

## Setting a cooking duration

Example: To bake a cake for 1 hour 5 minutes

- Place the food in the oven.
- Select the required oven function and the temperature.

The oven heating, lighting and cooling fan will switch on.

- Press > repeatedly until  starts flashing.



**0:00** will appear.

- Press OK.

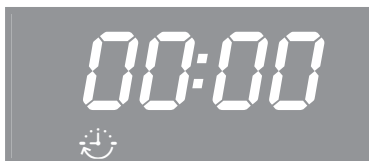

**00:00** will appear and the hour numeric block will start to flash.

If you then press < once, two lines will appear and, after pressing again, the maximum possible hour value **##** will appear.





- Use < or > to set the hours.
- Press OK.

The hours are saved and the minutes will flash.



- Use < or > to set the minutes.
- Press OK.

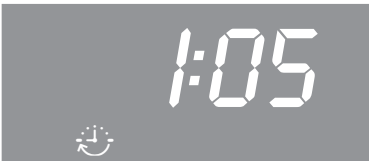

The cooking duration is saved and then counts down in minutes, with the last minute counting down in seconds.

The  symbol indicates a cooking duration has been set.

## At the end of the cooking duration

- 0:00 will appear,
-  will start to flash,
- the oven heating will switch off automatically,
- the cooling fan will continue to run for a while,
- a buzzer will sound for approx. 7 minutes, if this option is selected (see "Clock timer - Altering settings").

- Press OK.

As soon as you press OK,

- the buzzer will stop and the symbols in the display will go out.
- the time of day will appear,
- and the oven heating will switch on again.

- Turn the function selector to 0 and the temperature selector to ●.

- Take the food out of the oven.

# Clock/timer

## Setting a cooking duration and finish time

A cooking duration and finish time can be set to switch a cooking programme on and off automatically.

Example:

The time is now 11:15 ;  
you want a dish with a cooking duration of 90 minutes to be ready by 13:30 .

- Place the food in the oven.
- Select the required oven function and the temperature.

The oven heating, lighting and cooling fan will switch on.

### Set the cooking duration first:

- Press > repeatedly until  starts flashing.
- Press OK.

00:00 will appear and the hour numeric block will start to flash.

- Use < or > to set the hours.
- Press OK.

The hours are saved and the minutes will flash.

- Use < or > to set the minutes.
- Press OK.

The cooking duration is now saved.



The  symbol indicates a cooking duration has been set.

### Now set the finish time:

- Press > repeatedly until  starts flashing.



12:45 will appear in the display (= current time of day + cooking duration = 11:15 + 1:30).

- Press OK.

The hours will flash.

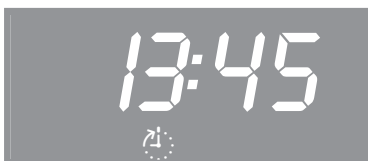

- Use < or > to set the hours.
- Press OK.

The hours are saved and the minutes will flash.

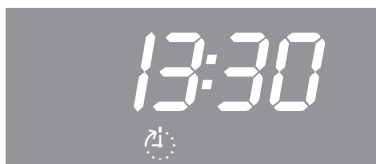

- Use < or > to set the minutes.
- Press OK.

The finish time  is now saved.

The oven heating, lighting and cooling fan will switch off.

The selected finish time appears in the display.

As soon as the start time ( $13:30 - 1:30 = 12:00$ ) is reached, the oven heating, lighting and cooling fan will switch on.

The set cooking duration  appears and then counts down in minutes, with the last minute counting down in seconds.

### Altering the cooking duration

- Press > repeatedly until  starts flashing.

The cooking duration remaining will appear in the display.

- Press OK.

The hours will flash.

- Use < or > to set the hours.

- Press OK.

The minutes block will flash.

- Use < or > to set the minutes.

- Press OK.

The altered cooking duration is now saved.

# Clock/timer

## Deleting a cooking duration

- Press < or > repeatedly until  starts to flash.

- Press OK.

The hours will flash.

- Press < or > repeatedly until two lines appear.

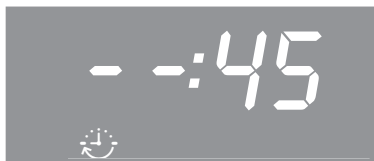

- Press OK.

Four lines will appear:



- Press OK.

The cooking duration and any finish time will be deleted.

The time of day will appear unless a minute minder time has been set.

The oven heating, lighting and cooling fan will switch on.

If you want to finish the cooking programme:

- Turn the function selector to **0** and the temperature selector to **●**.
- Take the food out of the oven.

## Deleting a finish time

- Press < or > repeatedly until  starts to flash.

- Press OK.

The hours will flash.

- Press < or > repeatedly until two lines appear.

- Press OK.

Four lines will appear.

- Press OK.

The  symbol will appear and the set cooking duration will count down in minutes, with the last minute counting down in seconds.

If you want to finish the cooking programme:

- Turn the function selector to **0** and the temperature selector to **●**.
- Take the food out of the oven.

If you turn the function selector to **0**, the settings for the cooking duration and the finish time will be deleted.

## Altering the time of day

The time of day can only be changed when the function selector is at **0**.

- Turn the function selector to **0**.
- Press > repeatedly until ⊕ starts to flash.
- Press OK.

The hours will flash.

- Use < or > to set the hours.
- Press OK.

The hours are saved and the minutes will flash.

- Use < or > to set the minutes.
- Press OK.

The time of day is now saved.

After a power cut, the time of day needs to re-entered.

# Clock/timer

---

## Altering settings

Your appliance is supplied with a number of standard default settings (see the "Settings overview" chart).

A setting *P* can be changed by altering its status *S*.

- Turn the function selector to **0**.
- Press and hold < until *P* / appears.



- If you want to change another setting, press < or > repeatedly until the relevant number appears.

- Press OK.



The setting is selected and the current status *S* appears, e.g. *0*.

To alter the status:

- Press < or > repeatedly until the required status appears in the display.
- Press OK.

The selected status is saved and the setting *P* appears again.

If you wish to alter more settings, proceed as described previously.

If you do not want to alter any more settings:

- Wait for approx. 15 seconds until the time of day appears.

The settings remain in the memory even after a power cut.

## Settings overview

Setting	Status	
<i>P 1</i> <b>Buzzer volume</b>	<i>S 0</i> <i>S 1</i> to <i>S 30*</i>	The buzzer is <b>switched off</b> . The buzzer is <b>switched on</b> . The volume can be altered. When you select a status you will hear the corresponding buzzer.
<i>P 2</i> <b>Clock format</b>	<i>24*</i> <i>12</i>	The time of day is shown in <b>24-hour</b> format. The time of day is shown in <b>12 hour</b> format. If you change the clock after 13:00 from a 12 hour clock to a 24 hour clock you will need to update the hour numerical block for the clock accordingly.
<i>P 3</i> <b>System lock for the oven</b>	<i>S 0*</i> <i>S 1</i>	The system lock is <b>switched off</b> . The system lock is <b>switched on</b> and  appears in the display. The system lock prevents the oven from being used unintentionally. The system lock remains active even after a power cut.
<i>P 4**</i> <b>Keypad tone</b>	<i>S 0</i> <i>S 1*</i>	Keypad tone <b>deactivated</b> . Keypad tone <b>activated</b> .

\* Factory default setting

\*\* Only applies to H266xB



# Baking

---

Eating food which has been cooked correctly is important for good health.



Only bake cakes, pizza, chips etc. until they are golden. Do not overcook them.

## Functions:

Depending on how the food is prepared, you can use Fan Plus , Intensive Bake  or Conventional Heat .

## Bakeware

The choice of bakeware depends on the oven function and preparation.

- Fan plus , Intensive bake  : Baking tray, universal tray, bakeware of any ovenproof material.
- Conventional heat  : Dark metal, enamel, tin or aluminium baking tins with a matt finish, heat-resistant glass or ceramic dishes. Avoid using bright, shiny metal tins as they give an uneven and poor browning result and in some cases cakes might not cook properly.

- Always place baking tins on the rack. Position rectangular tins with the longer side across the width of the rack for optimum heat distribution and even baking results.
- When baking cakes with fresh fruit toppings and deep sponge cakes place the tin in the universal tray to catch any spillages.

## Baking parchment, greasing the tin

All Miele accessories (baking tray, universal tray, perforated gourmet baking tray and the round baking tray) are treated with PerfectClean enamel.

Surfaces treated with PerfectClean enamel generally do not need to be greased or covered with baking paper.

Baking paper is only needed with

- anything with a high salt content (e.g. pretzels, bread sticks), because sodium can damage the PerfectClean surface,
- meringues or sponges with a high egg-white content, because they are more likely to stick,
- frozen food cooked on the rack.



## Notes on the baking chart

### Temperature

As a general rule, select the lower temperature given in the chart.

Baking at temperatures higher than those recommended may reduce the cooking time, but will lead to uneven browning, and unsatisfactory cooking results.

### Baking duration

Check if the food is cooked at the end of the shortest time quoted.

To check if a cake is ready, insert a wooden skewer into the centre. It is ready if the skewer comes out clean, without dough or crumbs sticking to it.



### Shelf levels <sup>5</sup>

The shelf level on which you place your food for baking depends on the oven function and number of trays being used.

- Fan plus   
1 tray: level 2  
2 trays: level 1+3  
3 trays: level 1+3+5





When using the universal tray and baking tray to bake on two or more levels at the same time, place the universal tray underneath the baking tray.

Bake moist biscuits and cakes on a maximum of two levels at the same time.

- Intensive bake   
1 tray: level 1
- Conventional   
1 tray: level 1 or 2

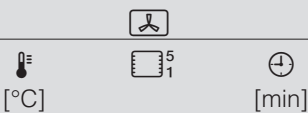
# Baking









## Baking chart

Cakes / biscuits			
	 [°C]	 [tray(s)]	 [min]
<b>Creamed mixture</b>			
Sponge cake	<b>150–170</b>	<b>2</b>	<b>60–70</b>
Ring cake	<b>150–170</b>	<b>2</b>	<b>65–80</b>
Muffins (1 [2] tray(s))	<b>150–170</b>	<b>2 [1+3<sup>4</sup>]</b>	<b>30–50</b>
Small cakes (1 tray) <sup>1) 2)</sup>	<b>150</b>	<b>2</b>	<b>26–40</b>
Small cakes (2 trays) <sup>1) 2)</sup>	<b>150<sup>3)</sup></b>	<b>2+4</b>	<b>28–40</b>
Foam cake (tray)	<b>150–170</b>	<b>2</b>	<b>25–40</b>
Marble, nut cake (tin)	<b>150–170</b>	<b>2</b>	<b>60–80</b>
Fresh fruit cake, with meringue topping (tray)	<b>150–170</b>	<b>2</b>	<b>45–50</b>
Fresh fruit cake (tray)	<b>150–170</b>	<b>2</b>	<b>35–55</b>
Fresh fruit cake (tin)	<b>150–170</b>	<b>2</b>	<b>55–65</b>
Flan base <sup>1)</sup>	<b>150–170</b>	<b>2</b>	<b>25–35</b>
Small cakes/biscuits <sup>1)</sup> (1 [2] tray(s))	<b>150–170</b>	<b>2 [1+3<sup>4</sup>]</b>	<b>20–25</b>
<b>Rubbed in mixture</b>			
Flan base	<b>150–170</b>	<b>2</b>	<b>20–25</b>
Streusel cake	<b>150–170</b>	<b>2</b>	<b>45–55</b>
Small cakes/biscuits <sup>1)</sup> (1 [2] tray(s))	<b>150–170</b>	<b>2 [1+3<sup>4</sup>]</b>	<b>15–25</b>
Drop cookies <sup>1) 2)</sup> (1 [2] tray/s)	<b>140</b>	<b>2 [1+3<sup>4</sup>]</b>	<b>30–45</b>
Cheese cake	150–170	2	70–95
Apple pie (tin Ø 20 cm) <sup>1) 2)</sup>	<b>160</b>	<b>2</b>	<b>80–105</b>
Apple pie <sup>1)</sup>	160–180	2	50–70
Apricot tart with topping (tin)	150–170	2	55–75
Swiss apple cake	–	–	–

The data for the recommended function is printed in bold.

Unless otherwise stated, the times given are for an oven which has not been pre-heated. With a pre-heated oven, shorten times by up to 10 minutes.

In general, if a range of temperatures is given, it is best to select the lower temperature and to check the food after the shortest time.

					
 [°C]	 5 1	 [min]	 [°C]	 5 1	 [min]
150–170	2	60–70	–	–	–
150–170	2	65–80	–	–	–
160–180	2	25–45	–	–	–
<b>160<sup>3)</sup></b>	<b>3</b>	<b>23–35</b>	–	–	–
–	–	–	–	–	–
170–190	2	25–40	–	–	–
150–170	2	60–80	–	–	–
170–190	2	45–50	–	–	–
170–190	1	35–55	–	–	–
160–180	2	55–65	–	–	–
170–190	2	20–25	–	–	–
160–180 <sup>3)</sup>	3	15–25	–	–	–
170–190 <sup>3)</sup>	2	15–20	–	–	–
170–190	2	45–55	–	–	–
160–180 <sup>3)</sup>	3	15–25	–	–	–
<b>160<sup>3)</sup></b>	<b>2</b>	<b>15–33</b>	–	–	–
<b>160–180</b>	<b>2</b>	<b>85–95</b>	150–170	2	75–90
<b>180</b>	<b>1</b>	<b>80–95</b>	–	–	–
170–190	1	45–65	<b>160–180</b>	<b>1</b>	<b>50–70</b>
170–190	2	55–75	<b>150–170</b>	<b>2</b>	<b>50–60</b>
<b>220–240<sup>3)</sup></b>	<b>1</b>	<b>35–50</b>	<b>190–210<sup>3)</sup></b>	<b>1</b>	<b>25–40</b>





 Fan plus /  Conventional heat /  Intensive bake

 Temperature /  5  
1 Shelf level /  Duration

- 1) Do not use Rapid heat-up  during the heating-up phase.
- 2) The settings also apply for testing in accordance with EN 60350.
- 3) Pre-heat the oven.
- 4) Take the baking trays out of the oven early if the food is sufficiently browned before the specified time has elapsed.

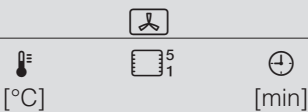
# Baking









## Baking chart

Cakes / biscuits			
	 [°C]	 <sup>5</sup>	 [min]
<b>Sponge mix<sup>1)</sup></b>			
Tart / flan base (2 eggs) <sup>1)</sup>	170–190	2	15–20
Sponge cake (4 to 6 eggs) <sup>1)</sup>	175–195	2	22–30
Whisked sponge cake <sup>1) 2)</sup>	<b>170</b>	<b>2</b>	<b>25–33</b>
Swiss roll <sup>1)</sup>	160–180	2	15–25
<b>Yeast mixtures and quark dough</b>			
Proving dough	<b>50</b>	<sup>5)</sup>	<b>15–30</b>
Gugelhupf	<b>150–170</b>	<b>2</b>	<b>50–60</b>
Stollen	<b>150–170</b>	<b>2</b>	<b>55–65</b>
Streusel cake	<b>150–170</b>	<b>2</b>	<b>35–45</b>
Fresh fruit cake (tray)	<b>160–180</b>	<b>2</b>	<b>40–60</b>
White bread	<b>160–180</b>	<b>2</b>	<b>50–60</b>
Wholegrain bread	<b>170–190<sup>3)</sup></b>	<b>2</b>	<b>50–60</b>
Pizza (tray) <sup>1)</sup>	170–190	2	35–45
Onion tart	170–190	2	35–45
Apple turnovers (1 [2] tray(s))	<b>150–170</b>	<b>2 [1+3<sup>4)</sup></b>	<b>25–30</b>
<b>Choux pastry<sup>1)</sup>, Eclairs (1 [2] tray(s))</b>	<b>160–180</b>	<b>2 [1+3<sup>4)</sup></b>	<b>30–45</b>
<b>Puff pastry (1 [2] tray(s))</b>	<b>170–190</b>	<b>2 [1+3<sup>4)</sup></b>	<b>20–25</b>
<b>Meringues, Macaroons (1 [2] tray(s))</b>	<b>120–140</b>	<b>2 [1+3<sup>4)</sup></b>	<b>25–50</b>

The data for the recommended function is printed in bold.

Unless otherwise stated, the times given are for an oven which has not been pre-heated. With a pre-heated oven, shorten times by up to 10 minutes.

In general, if a range of temperatures is given, it is best to select the lower temperature and to check the food after the shortest time.

					
 [°C]	 5 1	 [min]	 [°C]	 5 1	 [min]
<b>170–190</b> <sup>3)</sup>	<b>2</b>	<b>10–20</b>	–	–	–
<b>170–190</b> <sup>3)</sup>	<b>2</b>	<b>20–40</b>	–	–	–
<b>150–180</b> <sup>3)</sup>	<b>2</b>	<b>20–45</b>	–	–	–
<b>180–200</b> <sup>3)</sup>	<b>2</b>	<b>12–16</b>	–	–	–
50	<sup>5)</sup>	15–30	–	–	–
160–180	1	50–60	–	–	–
150–170	2	55–65	–	–	–
170–190	2	35–45	–	–	–
160–180 <sup>1)</sup>	3	40–55	170–190	2	40–55
160–180	2	50–60	–	–	–
190–210 <sup>3)</sup>	2	50–60	–	–	–
<b>190–210</b>	<b>2</b>	<b>30–45</b>	170–190	2	40–50
<b>180–200</b>	<b>2</b>	<b>25–35</b>	170–190	2	25–35
160–180	2	25–30	–	–	–
180–200 <sup>3)</sup>	3	30–40	–	–	–
190–210 <sup>3)</sup>	2	20–25	–	–	–
120–140 <sup>3)</sup>	2	25–50	–	–	–

 Fan plus /  Conventional heat /  Intensive bake



 Temperature /  Shelf level /  Duration

- 1) Do not use Rapid heat-up  during the heating-up phase.
- 2) The settings also apply for testing in accordance with EN 60350.
- 3) Pre-heat the oven.
- 4) Take the baking trays out of the oven early if the food is sufficiently browned before the specified time has elapsed.
- 5) Place the rack on the floor of the oven, and stand the bowl containing the dough on the rack.

# Roasting

---

## Functions:

Depending on how the food is prepared, you can use Fan Plus  or Conventional Heat .

## Crockery

You can use any heat-resistant crockery:



Miele Gourmet oven dishes, roasting pans, ovenproof glass trays, roasting bags, dishes made from earthenware or cast iron, the universal tray, rack and/or anti-splash insert (if available) on top of the universal tray.

We recommend roasting in oven dishes as this ensures that sufficient stock remains for making gravy. The oven also stays cleaner than with open roasting.

## Notes on the roasting chart

### Temperature

As a general rule, select the lower temperature given in the chart. If higher temperatures are used, the meat will brown on the outside, but will not be properly cooked through.

When cooking with Fan Plus , select a temperature of 20 °C lower than for Conventional Heat .

For cuts which weigh more than 3 kg, select a temperature approx. 10 °C lower than that given in the roasting chart. Roasting will take longer at the lower temperature, but will be more even.

When roasting on the rack, set a temperature of approx. 10 °C lower than in an oven dish.

### Pre-heating

Pre-heating is required when roasting beef sirloin joints and fillet.

## Roasting duration ⊕

The traditional British method for calculating the roasting time is to allow 15 to 20 minutes per lb/450 grammes, according to type of meat, plus approx. 20 minutes, adjusting the length of time as roasting proceeds to obtain the required result. The roasting time can also be determined by multiplying the thickness of the roast [cm] with the time per cm [min/cm], depending on the type of meat:

Beef/venison: . . . . . 15–18 min/cm

Pork/veal/lamb: . . . . . 12–15 min/cm

Sirloin/fillet: . . . . . 8–10 min/cm

Check if the meat is cooked after the shortest duration quoted.

## Shelf levels

As a general rule, use shelf level 2.

## Tips

### Browning

Browning only occurs towards the end of the roasting time. Remove the lid about halfway through the roasting time if a more intensive browning result is desired.

### Standing time

At the end of the programme, take the roast out of the oven, wrap in aluminium foil and leave to stand for about 10 minutes. This helps retain juices when the meat is carved.

### Roasting poultry

For a crisp finish, baste the poultry 10 minutes before the end of the cooking time with slightly salted water.

# Roasting

---

## Roasting chart

<b>Meat/Fish</b>
Topside of beef, approx. 1 kg <sup>1)</sup>
Beef fillet or sirloin joint, approx. 1 kg <sup>2)</sup>
Venison, approx. 1 kg <sup>3)</sup>
Pork joint/rolled meat, approx. 1 kg <sup>3)</sup>
Pork joint with crackling, approx. 2 kg <sup>3)</sup>
Gammon joint, approx. 1 kg <sup>3)</sup>
Meat loaf, approx. 1 kg <sup>3)</sup>
Veal, approx. 1.5 kg <sup>3)</sup>
Leg of lamb, approx. 1.5 kg <sup>2)</sup>
Saddle of lamb, approx. 1.5 kg
Poultry, 0.8–1 kg
Poultry, approx. 2 kg
Poultry, stuffed, approx. 2 kg
Poultry, approx. 4 kg
Fish, whole, approx. 1.5 kg

The data for the recommended function is printed in bold.

The times given are for an oven which has not been pre-heated.









In general, if a range of temperatures is given, it is best to select the lower temperature and to check the food after the shortest time.

The temperatures quoted are for roasting in an open dish.



Lower the temperature by approx. 10 °C if roasting directly on the universal tray or on the rack with the universal tray underneath.



# Roasting

					
 [°C]	 5 1	 [min]	 [°C]	 5 1	 [min]
170–190	2	100–130	<b>190–210</b>	<b>2</b>	<b>110–140</b>
<b>200–220</b>	<b>2</b>	<b>45–55</b>	200–220	2	45–55
<b>140–160</b>	<b>2</b>	<b>100–120</b>	150–170	2	100–120
160–180	2	100–120	<b>180–200</b>	<b>2</b>	<b>100–120</b>
160–180	2	130–160	<b>190–210</b>	<b>2</b>	<b>140–180</b>
<b>150–170</b>	<b>2</b>	<b>60–80</b>	170–190	2	80–100
160–180	2	60–70	<b>190–210</b>	<b>2</b>	<b>60–70</b>
<b>180–200</b>	<b>2</b>	<b>80–100</b>	190–210	2	100–120
<b>170–190</b>	<b>2</b>	<b>90–120</b>	200–220	2	90–120
170–190	2	50–60	<b>190–210</b>	<b>2</b>	<b>50–60</b>
<b>180–200</b>	<b>2</b>	<b>60–70</b>	190–210	3	60–75
<b>170–190</b>	<b>2</b>	<b>90–110</b>	190–210	3	90–110
<b>170–190</b>	<b>2</b>	<b>110–130</b>	190–210	3	110–130
<b>160–180</b>	<b>2</b>	<b>150–180</b>	180–200	2	150–180
<b>160–180</b>	<b>2</b>	<b>35–55</b>	190–210	2	35–55

 Fan plus /  Conventional heat

 Temperature /  5  
1 Shelf level /  Duration

- 1) Roast with the lid on first, then remove the lid halfway through roasting and add approx. ½ litre liquid.
- 2) Pre-heat the oven, but do not use Rapid heat-up .
- 3) Add approx. ½ litre liquid halfway through roasting.

# Low temperature cooking

This method is ideal for cooking beef, pork, veal or lamb when a tender result is required.

First sear the meat all over at a high temperature on the hob in order to seal it.

Then place the meat in the pre-heated oven where the low temperature and long cooking time will cook it to perfection and ensure it is very tender.

The meat relaxes and the juices inside start to circulate evenly throughout the meat to reach the outer layers. This has very tender and succulent results.

## Tips

- Use lean meat which has been correctly hung and trimmed. Bones should be removed before cooking.
- For searing, use a suitable cooking oil or fat that can withstand high temperatures (e.g. clarified butter, vegetable oil).
- Do not cover meat during cooking.

Cooking takes between 2-4 hours depending on the size and weight of the meat and on how well cooked you want it as well as the level of browning required.

## Procedure

Use the universal tray with the rack placed on top of it.

Do not use the Rapid Heat-up  function to pre-heat the oven.

- Place the rack together with the universal tray on shelf level 2.
- Select Conventional heat  and a temperature of 130 °C.
- Pre-heat the oven together with the universal tray and rack for approx. 15 minutes.
- Whilst the oven is pre-heating, sear the meat thoroughly on the hob.

 **Danger of burning!**  
Use oven gloves when placing food in the oven, turning or removing it and when adjusting oven shelves etc. in a hot oven.

- Place the seared meat on the rack.
- Reduce the temperature to 100 °C.
- Continue cooking until the end of the cooking duration.

On models with a clock/timer, you can set this procedure to finish automatically, see the "Clock/timer - Entering a cooking duration").

## Low temperature cooking

### After cooking

Because the cooking and core temperatures are very low:

- Meat can be carved straight from the oven. It does not need to rest.
- The cooking result will not be affected if the meat is left in the oven after the programme has finished. It can be kept warm until you serve it.
- The meat is an ideal temperature to eat straight away. Serve on pre-heated plates with very hot sauce or gravy to prevent it cooling down too quickly.

### Cooking duration/Core temperatures

Meat	Duration [min]	Core temperature** [°C]
Sirloin joint		
– Rare	60–90	48
– Medium	120–150	57
– Well-done	180–240	69
Pork fillet	120–150	63
Gammon*	150–210	68
Saddle of veal*	180–210	63
Saddle of lamb*	90–120	60

\* Boned

\*\* You can use a proprietary food probe if you have one to monitor the core temperature.

# Grilling



Danger of burning.

Grill with the oven door closed. If you grill with the door open, hot air will escape from the oven instead of being cooled by the cooling fan.

The controls will get hot.

## Functions

### Grill

For grilling larger quantities of thin cuts (e.g. steaks) and browning baked dishes.

The whole of the top heating / grill element will get hot and glow red.

### Fan grill

For grilling larger items, e.g. rolled meat, poultry.

The top heating / grill element and the fan switch on and off alternately.

## Trays and racks

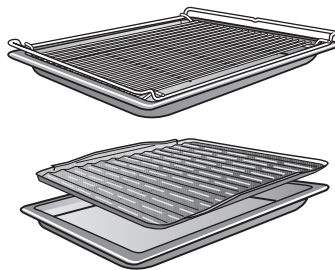

Use the universal tray with the rack or anti-splash insert (if available) on top. The juices from the food being cooked collect under the insert. This prevents them from spitting and making the oven dirty. The juices can then be used for making gravy and sauces.

Do not use the baking tray.

## Notes on the grilling chart

### Temperature

As a general rule, select the lower temperature given in the chart. If higher temperatures are used, the meat will brown on the outside, but will not be properly cooked through.

The  setting is recommended for thin cuts of meat. For thicker cuts of meat, the maximum temperature can be set to 240 °C.

### Pre-heating

Always pre-heat the grill for approx. 5 minutes with the door closed.

### Shelf levels

Select the shelf level according to the thickness of the food.

- Thin cuts: Shelf level 4/5
- Thicker cuts: Shelf level 2/3

### Grilling duration

- Flat pieces of fish and meat usually take 6–8 minutes per side. Thicker pieces require more time for each side. It is best to grill food of a similar thickness at the same time so that the grilling time for each item does not vary too greatly.
- Turn the food halfway through cooking.

## Testing to see if cooked

One way of finding out how well a piece of meat has been cooked is to press down on it with a spoon:

- Rare:** If the meat gives easily to the pressure of the spoon, it will still be red on the inside.
- Medium:** If there is some resistance, the inside will be pink.
- Well-done:** If there is very little resistance, it is cooked through.

Check if the meat is cooked after the shortest time quoted.

## Tip

If the surface of thicker cuts of meat is cooked but the centre is still raw, continue grilling at a lower temperature setting or use a lower shelf level to allow the food to cook through to the centre.

# Grilling

---

## Preparing food for grilling

Trim the meat. Do not season meat with salt before grilling as this draws the juices out.

Add a little oil to lean meat if necessary. Do not use other types of fat as they can burn and cause smoke.

Clean fish in the normal way. To enhance the flavour, add a little salt or squeeze a little lemon juice over the fish.

## Grilling

- Place the rack or the anti-splash insert (if available) in the universal tray.
- Place the food on top.
- Select the required oven function and the temperature.
- Pre-heat the grill for approx. 5 minutes with the door closed.



**Danger of burning.**

Use oven gloves when placing food in the oven, turning or removing it and when adjusting oven shelves etc. in a hot oven.

- Place the food on the appropriate shelf level (see the Grilling chart).
- Close the door.
- Turn the food halfway through grilling.





















## Grilling chart

The data for the recommended function is printed in bold.

Pre-heat the grill for approx. 5 minutes with the door closed, unless advised otherwise.

Turn the food halfway through the cooking time.

Check the food after the shortest time quoted.

Food to be grilled	 5				
		 [°C]	 [min]	 [°C]	 [min]
<b>Thin cuts</b>					
Steak	4		15–22	<b>220</b>	<b>15–20</b>
Beef burgers <sup>1)</sup>	5 <sup>3)</sup>		<b>17–35</b>	–	–
Kebabs	3		25–30	<b>220</b>	<b>25–30</b>
Chicken kebabs	4		20–25	<b>220</b>	<b>12–16</b>
Pork chops	5		<b>18–22</b>	220	17–23
Liver	4		<b>8–12</b>	220	12–15
Burgers	4		<b>20–25</b>	220	18–22
Sausages	4		<b>12–18</b>	220	13–19
Fish fillet	4		20–25	<b>220</b>	<b>13–18</b>
Trout	4		<b>16–20</b>	220	20–25
Toast <sup>1) 2)</sup>	3		<b>7–12</b>	220	7–10
Cheese toast	3		10–15	<b>220</b>	<b>10–15</b>
Tomatoes	4		6–10	<b>220</b>	<b>8–10</b>
Peaches	4		6–10	<b>220</b>	<b>15–20</b>
<b>Thicker cuts</b>					
Chicken, approx. 1 kg	1 <sup>4)</sup>	240	50–60	<b>200</b>	<b>60–65</b>
Pork, approx. 1 kg	1	–	–	<b>200</b>	<b>95–100</b>
Sirloin joint, fillet, approx. 1 kg	2	–	–	<b>250</b>	<b>35–45</b>

 Grill /  Fan grill /  Shelf level /  Temperature /  Duration

1) The settings also apply when using the Grill  function for testing in accordance with EN 60350.

2) Do not pre-heat the oven.

3) Place the rack on shelf level 5 and the universal tray on shelf level 2.

4) Use shelf level 2 for Fan grill .

# Defrosting

Use the Defrost  function to gently defrost frozen food.

When this function is selected, only the fan switches on and circulates the air at room temperature.

 Danger of salmonella poisoning. It is particularly important to observe food hygiene rules when defrosting poultry. Do not use the liquid from the defrosted poultry. Pour it away, and wash the tray, the sink and your hands.

## Tips

- Where possible, remove the packaging and put the food to be defrosted on the universal tray or into a suitable dish.
- When defrosting poultry, put it on the rack over the universal tray to catch the defrosted liquid so that the meat is not lying in this liquid.
- Meat, poultry and fish do not need to be fully defrosted before cooking. Defrost so that the surface is sufficiently thawed to take herbs and seasoning.

## Defrosting durations

The duration needed for defrosting depends on the type and weight of the food.

Frozen food	Weight [g]	Duration [min]
Chicken	800	90–120
Meat	500	60–90
	1 000	90–120
Sausages	500	30–50
Fish	1 000	60–90
Strawberries	300	30–40
Butter cake	500	20–30
Bread	500	30–50





Drying is a traditional method of preserving fruit, certain vegetables and herbs.

It is important that fruit and vegetables are ripe and not bruised before they are dried.

- Prepare the food for drying
  - Peel and core apples, and cut into slices 0.5 cm thick.
  - Stone plums, if necessary.
  - Peel, core and cut pears into thick wedges.
  - Peel and slice bananas.
  - Clean mushrooms and cut them in half or slice them.
  - Remove parsley and dill from the stem.
- Distribute the food evenly over the universal tray.

Use the Gourmet perforated baking tray, if you have one.

- Select Fan plus  or Conventional heat .
- Select a temperature of 80–100 °C.
- Place the universal tray on shelf level 2.

With Fan plus  you can dry produce on levels 1+3 at the same time.

Food	Drying time
Fruit	2–8 hours
Vegetables	3–8 hours
Herbs*	50–60 minutes

\* Use Conventional heat  for drying herbs.

- Reduce the temperature if condensation begins to form in the oven.

 Danger of burning. Wear oven gloves when removing the dried food from the oven.

- Allow the dried fruit or vegetables to cool down after drying.

Dried fruit must be completely dry, but also soft and elastic.

- Store in sealed glass jars or tins.

# Frozen food/Ready meals

---

## Tips

### Cakes, pizza, baguettes

- Large frozen items such as cakes, pizzas or baguettes cover an extensive area of the baking tray or universal tray.  
The temperature difference if large frozen items are cooked in these trays can cause the tray to distort in such a way that it cannot be removed from the oven when it is hot. Further use will make the distortion worse. Place this type of food on baking parchment on the rack to prevent the risk of this happening.
- Use the lowest temperature recommended on the manufacturer's packaging.

### Oven chips, croquettes or similar items

- Small items of frozen food such as oven chips can be cooked on the baking tray or universal tray.  
Place baking parchment on the tray so that they cook gently.
- Use the lowest temperature recommended on the manufacturer's packaging.
- Turn several times during cooking.

## Method



Eating food which has been cooked correctly is important for good health.

Only bake cakes, pizza, chips etc. until they are golden. Do not overcook them.

- Select the function and temperature recommended on the manufacturer's packaging.
- Pre-heat the oven.
- Place the food in the pre-heated oven on the shelf level recommended on the packaging.
- Check the food at the end of the shortest duration recommended on the packaging.

## Gentle bake

The Gentle bake  function is ideal for bakes and gratins which require a crisp top.

Food	 [°C]	 5 1	 [min]
Lasagne	190	2	45–60
Potato gratin	180	2	55–65
Vegetable bake	180	2	55–65
Pasta bake	180	2	40–50















 Temperature /  Shelf level /  Duration

The table contains just a few examples.

For other recipes, use the temperature and time settings given for Fan plus  as a guide.

# Note for test institutes

## Test food acc. to EN 60350

Test food	Tray / tin	Oven function	🌡️ [°C]	📏 <sup>5</sup> <sub>1</sub>	⊕ [min]	Pre-heating
Drop cookies (8.4.1)	1 tray		140 <sup>2)</sup>	2	30–45	No
	2 trays <sup>1)</sup>		140 <sup>2)</sup>	1+3	30–45	No
	1 tray		160 <sup>2)</sup>	2	15–33	Yes
Small cakes (8.4.2)	1 tray		150 <sup>2)</sup>	2	28–40	No
	2 trays		150 <sup>2)</sup>	2+4	27–40	Yes
	1 tray		160 <sup>2)</sup>	3	23–35	Yes
Whisked sponge cake (8.5.1)	Springform Ø 26 cm <sup>3)</sup>		170 <sup>2)</sup>	2	25–33	No
	Springform Ø 26 cm <sup>3) 4)</sup>		150–180 <sup>2)</sup>	2	20–45	Yes
Apple pie (8.5.2)	Springform Ø 20 cm <sup>3)</sup>		160 <sup>2)</sup>	2	80–105	No
	Springform Ø 20 cm <sup>3)</sup>		180 <sup>2)</sup>	1	80–95	No
Toast (9.1)	Rack			3	7–12	No
Grill beef burgers (9.2)	Rack on top of universal tray			5 <sup>5)</sup>	1st side: 10–20 2nd side: 7–18	Yes, 5 minutes

 Fan plus /  Conventional heat /  Grill

🌡️ Temperature / 📏<sup>5</sup> Shelf level / ⊕ Duration

- 1) Take the baking trays out of the oven early if the food is sufficiently browned before the specified time has elapsed.
- 2) Do not use Rapid heat-up  during the heating-up phase.
- 3) Place baking tins on the rack.
- 4) In general, select the lowest temperature given and check the food after the shortest time.
- 5) Place the rack on shelf level 5 and the universal tray on shelf level 2.

## Energy rating

The Energy efficiency rating is determined according to EN 50304.

### Energy rating

**A**

Function used:

Fan plus 

Please note:

Do not use the FlexiClip telescopic runners

 Danger of burning. Make sure the oven heating elements are switched off and that the oven cavity is cool.

 Danger of injury. Do not use a steam cleaning appliance to clean this appliance. The steam could reach electrical components and cause a short circuit.

All external surfaces are susceptible to discolouration or change in appearance if unsuitable cleaning agents are used.

Oven cleaners and descaling agents will damage the front of the oven, in particular.

Residues of cleaning agents must be removed immediately after use. All surfaces are also susceptible to scratches. Scratches on glass surfaces could even cause a breakage in certain circumstances.

## Unsuitable cleaning agents

To avoid damaging the surfaces, do not use:

- cleaning agents containing soda, ammonia, acids or chlorides,
- cleaning agents containing descaling agents on the oven front,
- abrasive cleaning agents, e.g. powder cleaners and cream cleaners,
- solvent-based cleaning agents,
- stainless steel cleaning agents,
- dishwasher cleaner,
- glass cleaning agents,
- cleaning agents for ceramic hobs,
- hard, abrasive brushes or sponges, e. g. pot scourers, brushes or sponges which have been previously used with abrasive cleaning agents,
- melamine eraser blocks,
- sharp metal scrapers or tools,
- wire wool,
- spot cleaning,
- oven cleaner\*,
- stainless steel spiral pads\*.

\* these can, however, be used to remove very heavy soiling from PerfectClean treated surfaces.

# Cleaning and care

---

Soiling might become impossible to remove if it is not dealt with. Continued use of the oven without regular cleaning will make it much harder to keep clean. Soiling is, therefore, best removed after each use of the oven.

The accessories are not dishwasher-proof.

## Tips

- Soiling caused by spilt juices and cake mixtures is best removed whilst the oven is still warm. Exercise caution and make sure the oven is not too hot - danger of burning.
- To make cleaning easier you can dismantle the oven door, remove the side runners and the FlexiClip runners (if present), remove the catalytic back panel and lower the top heating/grill element.

## Normal soiling

See "Cleaning the catalytic enamelled back panel" for instructions on how to keep the back panel clean.

- It is best to remove normal soiling immediately using a clean sponge and a solution of hot water and washing-up liquid or with a clean, damp microfibre cloth.
- After cleaning make sure all residual cleaning agent is thoroughly removed with clean water. This is particularly important when cleaning PerfectClean surfaces as cleaning agent residues can impair the non-stick properties.
- After cleaning, wipe the surfaces dry using a soft cloth.

## Cleaning the seal

There is a seal around the oven interior which seals the oven interior and the inside of the door.

Grease deposits on the seal can cause it to become brittle and cracked.

- It is best to wipe the seal clean after each use.

### Stubborn soiling on the FlexiClip runners

Never attempt to clean FlexiClip telescopic runners in a dishwasher. This would remove the special grease which is essential for their smooth functioning.

For stubborn surface soiling or if the bearings become sticky with spilled fruit juices proceed as follows:

- Soak the FlexiClip runners for approx. 10 minutes in a solution of hot water and washing-up liquid. If necessary use the back of a washing-up sponge to remove the soiling. The bearings can be carefully cleaned with a soft brush.

Cleaning may cause some discolouration or fading in places, however this will not affect the functioning of the runners in any way.

### Cleaning the catalytic enamelled back panel

Soiling from oil and fat is burnt off catalytic enamel when very high temperatures are used in the oven.

The higher the temperature, the more effective the process.

Exposure to scouring agents, abrasive brushes or sponges and oven sprays can cause catalytic enamel to lose its self-cleaning properties.

Catalytic enamelled panels should therefore be taken out of the oven before using oven spray in it.

### Removing spice, sugar and similar deposits

- Remove the back panel (see "Cleaning and care - Removing the back panel").
- Clean the back panel by hand with a solution of hot water and washing-up liquid applied with a soft brush.
- Rinse it thoroughly and then leave it to dry before fitting it back in the oven.

# Cleaning and care

---

## Removing oil and grease splashes

- Remove any accessories from the oven including the side rails.
- Before starting the cleaning process, remove any large deposits of soiling from the inside of the door and the PerfectClean surfaces to avoid them burning on.
- Select the Fan plus  function and a temperature of 250 °C.
- Then heat the empty oven for at least an hour.

The length of time required will depend on the level of soiling.

If the catalytic coating is very heavily soiled with oil and grease, a film can form on the oven surface during the cleaning process.

 Danger of burning. Allow the oven to cool down before cleaning by hand.

- Clean the inside of the door and the oven interior with a clean sponge and a solution of hot water and washing-up liquid or a clean damp microfibre cloth.

Any remaining soiling will gradually disappear with each subsequent use of the oven at high temperatures.



## Removing the door

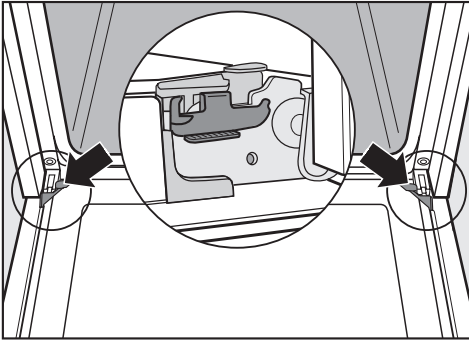

The oven door is connected to the hinges by retainers.

Before removing the door from the retainers, the locking clamps on both hinges have to be released.

- Open the door fully.

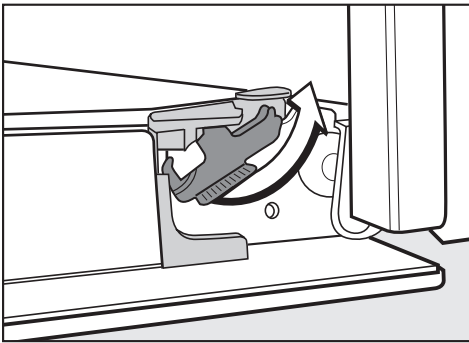

- Release the locking clamps by turning them as far as they will go.

Do not attempt to take the door off the retainers when it is in the horizontal position as the retainers will spring back against the oven.

Do not use the handle to pull the door off the retainers as the handle could break.

- Raise the door up till it rests open.



- Holding the door securely at both sides lift it upwards off the retainers. Make sure you take it off straight.

# Cleaning and care

## Dismantling the door

The oven door is an open system with three glass panes which have a heat-reflective coating on some of their surface.

When the oven is operating, air is directed through the door to keep the outer pane cool.

If soiling has worked its way in between the glass panes, the door can be dismantled in order to clean in between the panes.

Take particular care as scratches can damage the glass. When cleaning the glass panes do not use abrasive cleaning agents, hard sponges or brushes and do not use sharp metal tools or scrapers. Please also read the general notes on cleaning the oven front before cleaning the glass panes.

Oven spray will damage the aluminium trims inside the door. These should only be cleaned using hot water and washing-up liquid applied with a clean sponge or a clean, damp microfibre cloth.

Be especially vigilant after dismantling the door that the glass panes do not break.

 Danger of injury.  
Always remove the door before dismantling it.

- Place the door on a protective surface (e.g. on a tea towel) to prevent it getting scratched. The door handle should line up with the edge of the table. Make sure the glass lies flat and does not get broken during cleaning.

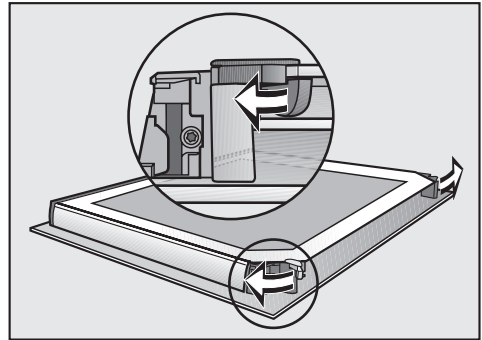

- Flip the two glass pane retainers outwards to open them.

## Cleaning and care

To remove the inner panes:

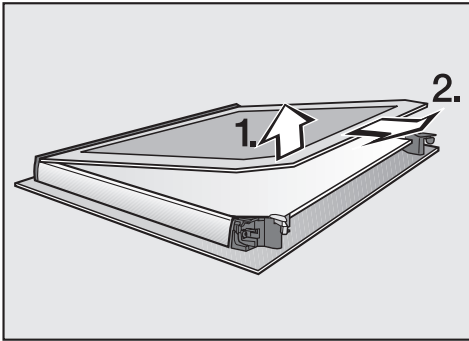

- **Gently** lift the inner pane up and out of the plastic strip.

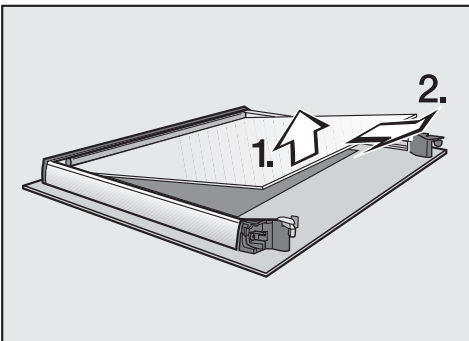

- Lift the middle pane up **gently** and pull it out.
- Clean the door panes and other individual parts with a clean sponge and a solution of hot water and washing-up liquid or a clean damp microfibre cloth.
- Dry all parts with a soft cloth.

Then reassemble the door carefully:

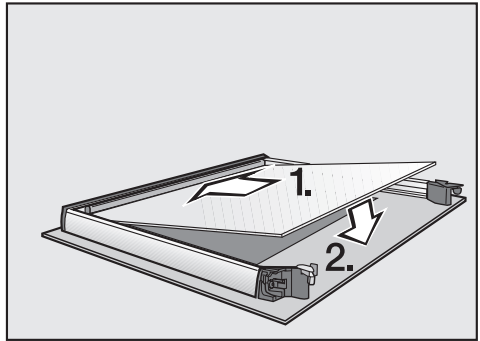

- Refit the middle pane in such a way that the material number is legible.

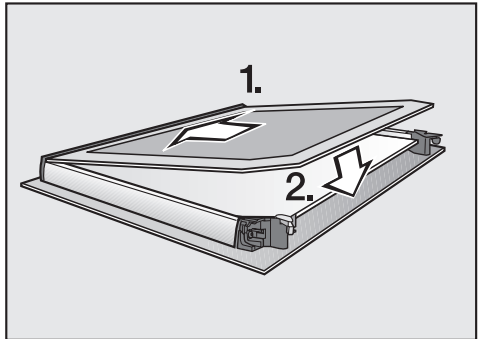

- Push the inner pane with the matt printed side facing downwards into the plastic strip and place it between the retainers.

## Cleaning and care

---

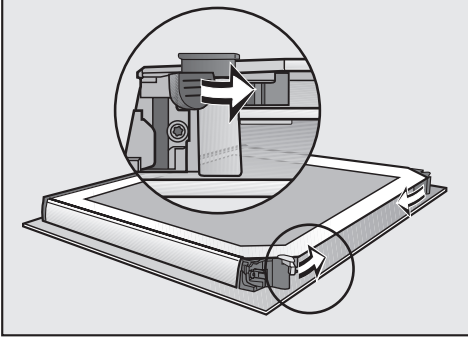

- Flip both the glass pane retainers inwards to close them.

The door is now reassembled and is ready to fit back on the oven.

## Refitting the door

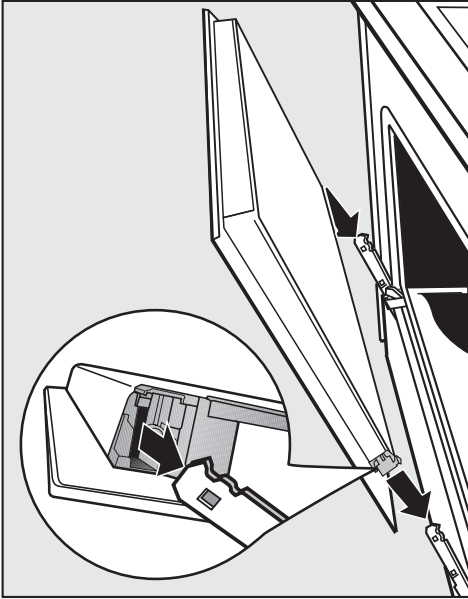

- Hold the door securely at both sides and carefully fit it back into the hinge retainers.

- Open the door fully.

It is essential that the locking clamps lock securely when the door is refitted after cleaning. Otherwise the door could work loose from the retainers and be damaged.

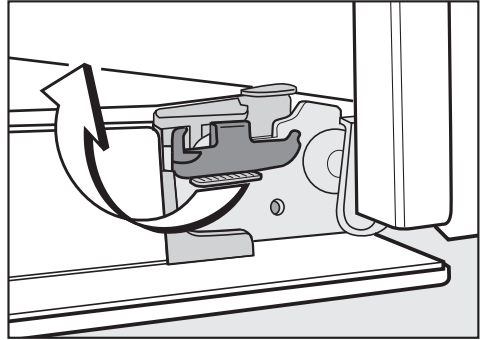

- Flip both locking clamps back up as far as they will go into a horizontal position.

## Cleaning and care

### Removing the side runners with FlexiClip runners

 Danger of injury.  
Do not use the oven without the side runners.

You can remove the side rails together with the FlexiClip runners (if present).

If you wish to remove the FlexiClip runners separately beforehand, please follow the instructions in "Features – Fitting and removing the FlexiClip runners".

 Danger of burning.  
Make sure the oven heating elements are switched off and cool.

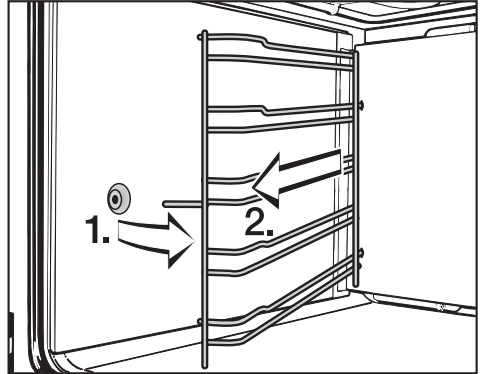

- Pull the rails out of holder (1) at the front of the oven and then pull them out of the oven (2).

**Refit** in the reverse order.

- Take care and ensure that all parts are correctly fitted.

## Removing the back panel

 Danger of injury.  
Do not use the oven without the back panel.

The back panel can be removed for cleaning purposes.

 Danger of burning.  
Make sure the oven heating elements are switched off and cool.

- Disconnect the appliance from the mains.
- Remove the side runners.
- Undo the four screws in the corners of the back panel and take it out.
- Clean the back panel (see "Cleaning and Care / Cleaning the catalytic enamelled back panel").

**Refit** in the reverse order.

Carefully refit the back panel. Make sure the openings are located as illustrated in "Oven overview".

- Reconnect the oven to the electricity supply.

## Lowering the top heat/grill element

 Danger of burning.  
Make sure the oven heating elements are switched off and cool.

- Remove the side runners.

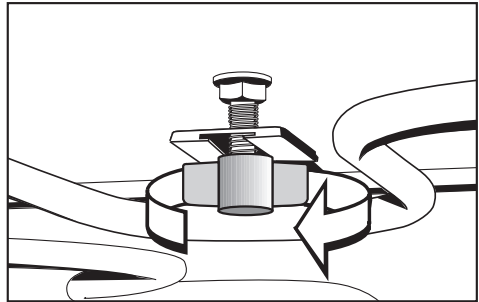

- Undo the wing nut.

Do not use force to lower the top heat/grill element as this can cause it to break.

- Carefully lower the top heat/grill element.

You can now clean the roof of the oven.

- Raise the top heat/grill element and tighten the wing nut securely.
- Refit the side runners.

## Problem solving guide

---

With the aid of the following guide, minor problems can be easily corrected without contacting Miele. The following guide may help you to find the reason for a fault, and to correct it. If having followed the suggestions below, you still cannot resolve the problem, please contact Miele (see back cover for contact details).

 Danger of injury.

Installation, maintenance and repairs may only be carried out by a suitably qualified and competent person. Repairs and other work by unqualified persons could be dangerous.

Miele cannot be held liable for unauthorised work.

Do not attempt to open the casing of the oven yourself.

<b>Problem</b>	<b>Possible cause and remedy</b>
The display is dark.	<p>There is no power to the oven.</p> <ul style="list-style-type: none"><li>■ Check whether the mains fuse has tripped. If it has, contact a qualified electrician or Miele.</li></ul>
The oven does not heat up.	<p>You have only selected an oven function or a temperature.</p> <ul style="list-style-type: none"><li>■ Select both a function <b>and</b> a temperature.</li></ul>
	<p>The system lock  has been switched on.</p> <ul style="list-style-type: none"><li>■ Switch off the system lock (see "Clock/timer - Altering settings").</li></ul>
	<p>There is no power to the oven.</p> <ul style="list-style-type: none"><li>■ Check whether the mains fuse has tripped. If it has, contact a qualified electrician or Miele.</li></ul>



## Problem solving guide

Problem	Possible cause and remedy
On ovens with a clock/timer, <b>12:00</b> starts flashing in the display.	<p>There has been a power cut.</p> <ul style="list-style-type: none"> <li>■ Reset the time of day (see "Using for the first time"). Cooking durations will also need to be reset for any programme in use.</li> </ul>
<b>0:00</b> appears unexpectedly in the display and  is flashing at the same time. The buzzer might also be sounding.	<p>The oven has been operating for an unusually long time and this has activated the safety switch-off function.</p> <ul style="list-style-type: none"> <li>■ Turn the function selector to <b>0</b>. The oven is now ready to use again immediately.</li> </ul>
A noise can be heard after a cooking process.	<p>The cooling fan is switched on. The cooling fan will switch off automatically when the temperature in the oven interior has fallen sufficiently.</p>
Spots like rust appear on catalytic surfaces.	<p>The catalytic cleaning process does not remove spices, sugar and similar deposits.</p> <ul style="list-style-type: none"> <li>■ Take catalytic panels out of the oven and remove this type of deposit with a mild solution of hot water and washing-up liquid applied with a soft brush (see "Cleaning and care / Cleaning the catalytic back panel").</li> </ul>

## Problem solving guide

Problem	Possible cause and remedy
Cakes and biscuits are not cooked properly after following the times given in the chart.	<p>A different temperature from the one given in the recipe was used.</p> <ul style="list-style-type: none"> <li>■ Select the temperature required for the recipe.</li> </ul>
	<p>The ingredient quantities are different from those given in the recipe.</p> <ul style="list-style-type: none"> <li>■ Double check the recipe. The addition of more liquid or more eggs makes a moister mix which would take longer to cook.</li> </ul>
Browning is uneven.	<p>The wrong temperature or shelf level was selected.</p> <ul style="list-style-type: none"> <li>■ There will always be a slight unevenness. If the unevenness is pronounced, check that the correct temperature and shelf level have been selected.</li> </ul>
	<p>The material or colour of the baking tin is not suitable for the oven function.</p> <ul style="list-style-type: none"> <li>■ With Conventional heat  light coloured, shiny tins are less suitable. Use matt, dark coloured tins.</li> </ul>
FlexiClip runners are not running smoothly.	<p>The bearings in the FlexiClip runners are not sufficiently lubricated.</p> <ul style="list-style-type: none"> <li>■ Lubricate the bearings with the special Miele lubricant.</li> </ul> <p>Only use this special lubricant, as it is designed to withstand high temperatures in the oven. Other lubricants can harden and stick to the telescopic runners when they are heated.</p> <p>The Miele lubricant is available to order from Miele or via the online Miele shop.</p>

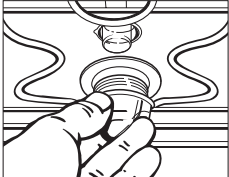
Problem	Possible cause and remedy
The oven lighting does not switch on.	<p data-bbox="376 233 801 264">The halogen lamp needs replacing.</p> <div data-bbox="376 276 1043 408" style="border: 1px solid gray; padding: 5px;"><p data-bbox="395 300 1005 392">Danger of burning. Make sure the oven heating elements are switched off and cool.</p></div> <ul data-bbox="376 427 897 459" style="list-style-type: none"><li>■ Disconnect the appliance from the mains.</li></ul>  <ul data-bbox="376 663 1016 960" style="list-style-type: none"><li>■ Turn the lamp cover a quarter turn anti-clockwise to release it and then pull it together with its seal downwards to take it out.</li><li>■ Replace it with a new halogen lamp (Osram 66725 AM/A, 230 V, 25 W, G9).</li><li>■ Refit the lamp cover together with its seal and turn clockwise to secure.</li><li>■ Reconnect the oven to the electricity supply.</li></ul>

# After Sales / Guarantee

---

## After sales service

In the event of any faults which you cannot easily remedy yourself or if the appliance is under guarantee, please contact

– your Miele Dealer

or

– the Miele Service Department

See end of this booklet for contact details.

When contacting contacting your Dealer or Miele, please quote the model and serial number of your appliance.

This information is given on the data plate, visible on the front frame of the oven, with the door fully open.

Please note that telephone calls may be monitored and recorded for training purposes.

N.B. A call-out charge will be applied to service visits where the problem could have been resolved as described in these instructions.

## Guarantee: U.K.

In the U.K, the appliance is guaranteed for 2 years from the date of purchase.

However, you must activate your cover by calling 0330 160 6640 or registering online at [www.miele.co.uk](http://www.miele.co.uk).

## Guarantee: Other countries

For information on the appliance guarantee specific to your country please contact Miele. See end of this booklet for contact details.



**Danger of injury.**

All electrical work should be undertaken by a suitably qualified and competent person.

Installation, repairs and other work by unqualified persons could be dangerous. Miele cannot be held liable for unauthorised work.

Ensure power is not supplied to the appliance until after installation or repair work has been carried out.

Connection of this appliance to the electricity supply must be made in accordance with current safety regulations (BS 7671 in the UK).

Connection of this appliance should be made via a fused connection unit or a suitable isolator and the on/off switch should be easily accessible after the appliance has been built in.

If the switch is not accessible after installation (depending on country) an additional means of disconnection must be provided for all poles.

When switched off there must be an all-pole contact gap of 3 mm in the isolator switch (including switch, fuses and relays according to EN 60335).

## Connection data

The required connection data are given on the data plate located on the oven trim visible when the door is open.

Ensure that these match the mains supply.

When contacting Miele, please quote the following:

- Model number
- Serial number
- Connection data (voltage/frequency/maximum connected load)

When replacing the cable supplied with another cable or changing the connection, only cable type H05VV-F with a suitable cross-sectional area (CSA) may be used (available from Miele Spare Parts).

# Electrical connection

---

## Oven

This oven is supplied with an approx. 1.7 m long 3-core cable for connection to a 230 V, 50 Hz supply.

The wires in the mains lead are coloured as follows:  
Green/yellow = earth;  
Blue = neutral;  
Brown = live

### **WARNING, THIS APPLIANCE MUST BE EARTHED**

For extra safety it is advisable to protect the appliance with a suitable residual current device (RCD).

Maximum connected load: see data plate.

## Appliance and niche dimensions

Dimensions are given in mm.

### Installation in a base unit

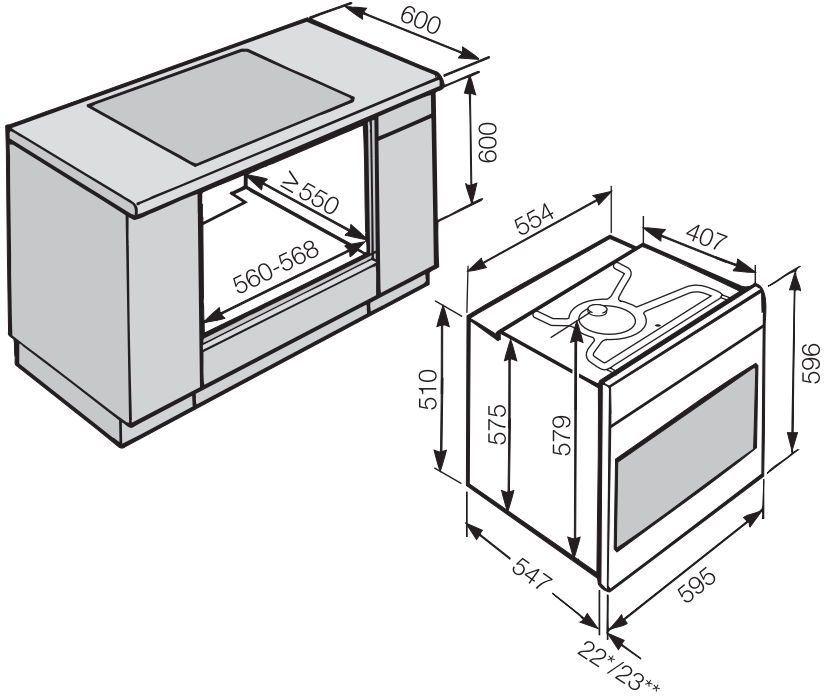

\* Ovens with glass front

\*\* Ovens with metal front

# Building-in diagrams

---

## Installation in a tall unit

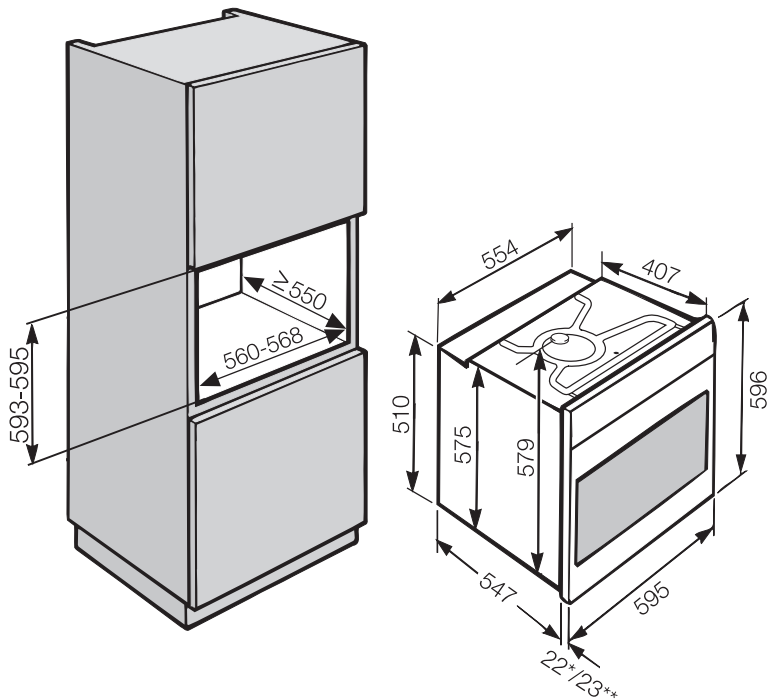

\* Ovens with glass front

\*\* Ovens with metal front



## Front dimensions

Dimensions are given in mm.

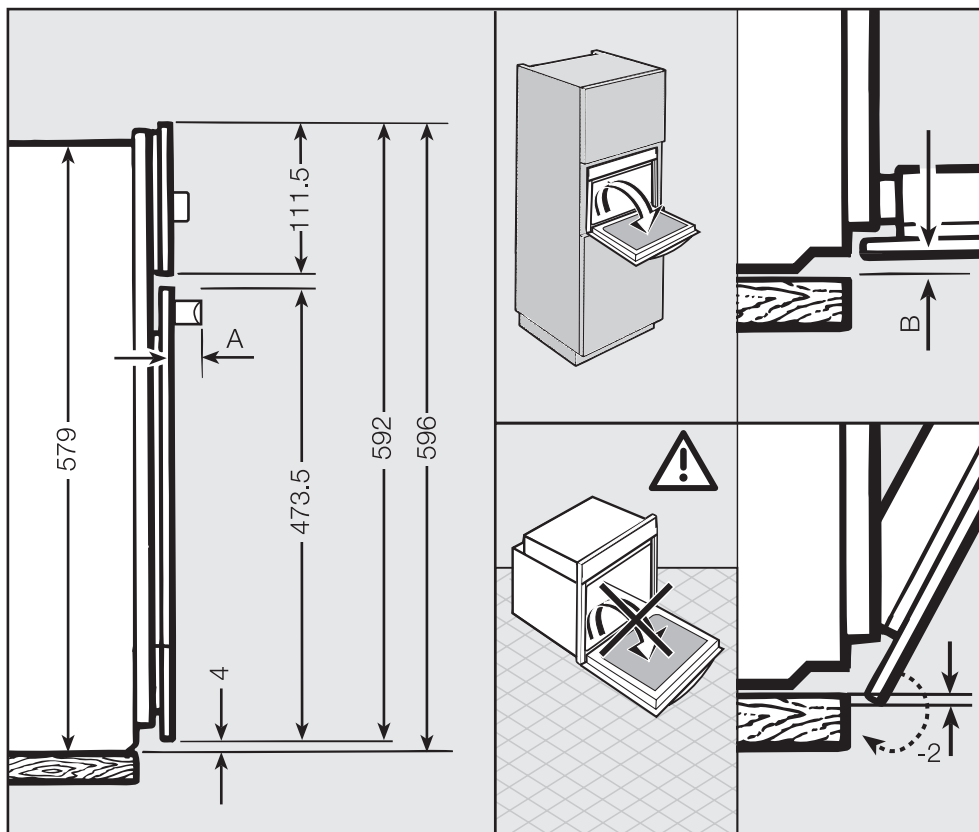

**A** H 23xx: 45 mm

H 24xx, H 26xx: 42 mm

**B** Ovens with glass front: 2.2 mm

Ovens with metal front: 1.2 mm

# Installing the oven

 The oven must not be operated until it has been correctly installed in its housing unit.

In order to function correctly, the oven requires an adequate supply of cool air. Ensure that the supply of cool air is not impaired (e.g. by heat insulation strips in the housing unit). Please also ensure that the cool air supply is not unduly heated by other heat sources such as a wood burning stove.

## Before installation

- Before connecting the appliance to the mains, you must disconnect the power supply to the isolator switch.

## Building in

- Connect the mains cable from the oven to the isolator.

Lifting the oven by the door handle can damage the door. Use the handle recesses on the side of the casing.

It is advisable to dismantle the door before installing the appliance (see "Cleaning and Care - Dismantling the door") and remove accessories from the oven cavity. This will make it easier to install in its niche and you will not be tempted into using the handle to carry it.

- Push the oven into the housing unit and align it.
- Open the door (if you have not removed it previously).

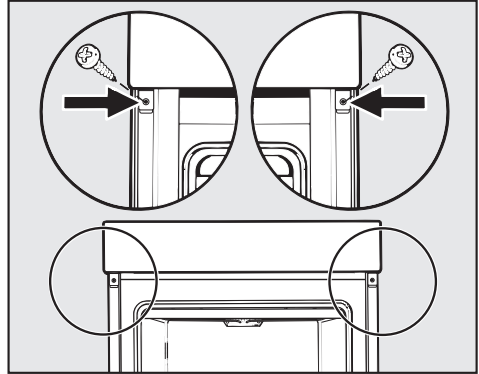

- Use the screws supplied to secure the oven to the side walls of the housing unit through the holes in the oven trim.
- Refit the door, if necessary (see "Cleaning and care - Refitting the door").

## United Kingdom

Miele Co. Ltd.  
Fairacres, Marcham Road  
Abingdon, Oxon, OX14 1TW  
Customer Contact Centre Tel: 0330 160 6600  
E-mail: mielecare@miele.co.uk  
Internet: www.miele.co.uk

## Australia

Miele Australia Pty. Ltd.  
ABN 96 005 635 398  
1 Gilbert Park Drive, Knoxfield, VIC 3180  
Tel: 1300 464 353, Fax: (03) 9764 7149  
Internet: www.miele.com.au

## China

Miele (Shanghai) Trading Ltd.  
1-3 Floor, No. 82 Shi Men Yi Road  
Jing' an District  
200040 Shanghai, PRC  
Tel: +86 21 6157 3500, Fax: +86 21 6157 3511  
E-mail: info@miele.cn, Internet: www.miele.cn

## Miele (Hong Kong) Limited

41/F - 4101, Manhattan Place  
23 Wang Tai Road  
Kowloon Bay, Hong Kong  
Tel: (852) 2610 1331, Fax: (852)2610 1013  
Email: mielehk@miele.com.hk

## India

Miele India Pvt. Ltd.  
Ground Floor, Copia Corporate Suites  
Plot No. 9, Jasola  
New Delhi - 110025  
Tel: 011-46 900 000, Fax: 011-46 900 001  
E-mail: customercare@miele.in, Internet: www.miele.in

## Ireland

Miele Ireland Ltd.  
2024 Bianconi Avenue  
Citywest Business Campus, Dublin 24  
Tel: (01) 461 07 10, Fax: (01) 461 07 97  
E-Mail: info@miele.ie, Internet: www.miele.ie

## Manufacturer: Miele & Cie. KG

Carl-Miele-Straße 29, 33332 Gütersloh, Germany

# Miele

## Malaysia

Miele Sdn Bhd  
Suite 12-2, Level 12  
Menara Sapura Kencana Petroleum  
Solaris Dutamas No. 1, Jalan Dutamas 1  
50480 Kuala Lumpur, Malaysia  
Phone: +603-6209-0288  
Fax: +603-6205-3768

## New Zealand

Miele New Zealand Limited  
8 College Hill  
Freemans Bay, Auckland 1011, NZ  
Tel: 0800 464 353, Fax: +64 9378 0146  
Internet: www.miele.co.nz

## Singapore

Miele Pte. Ltd.  
163 Penang Road  
# 04 - 03 Winsland House II  
Singapore 238463  
Tel: +65 6735 1191, Fax: +65 6735 1161  
E-Mail: info@miele.com.sg  
Internet: www.miele.sg

## South Africa

Miele (Pty) Ltd  
63 Peter Place, Bryanston 2194  
P.O. Box 69434, Bryanston 2021  
Tel: (011) 875 9000, Fax: (011) 875 9035  
E-mail: info@miele.co.za  
Internet: www.miele.co.za

## United Arab Emirates

Miele Appliances Ltd.  
P.O. Box 11 47 82  
Gold & Diamond Park  
Sheikh Zayed Road  
Building 6 / Offices Nos. 6-214 to 6-220  
Dubai  
Tel: +971-4-341 84 44  
Fax: +971-4-341 88 52  
E-Mail: info@miele.ae  
Internet: www.miele.ae

H2361B; H2661B; H2663B