

DESCRIPTION

The SB products are EAW's premium subwoofers designed for the most demanding professional applications. A broad range of capabilities and sizes provide the designer with selections that can be specifically matched to their application. Top quality drivers, engineered by EAW, provide the highest output and best sonic performance possible for a given form factor. All SB models are direct radiating, with optimally tuned, vented enclosures. SB subwoofers are the choice where the best sonic performance, highest reliability, and most robust physical construction are required.

The SB750zF is a high output, large-format subwoofer system. It is designed for portable use where the fatter-sounding output of dual 18 inch drivers is desired. The SB750zF works well with any full-range loudspeaker, but is specifically engineered to complement the KF750F Series in stacked or flown arrays. The SB750zF has the same footprint as KF750F Series loudspeakers. At one-and-a-half times the enclosure height, a two-high column of SB750zF's is the same height as a three-high column of KF750F loudspeakers. Each SB750zF comes with four cable links for arraying with KF750 loudspeakers. Its applications include: concert touring, arenas, band/club PA, large houses of worship, large auditoriums/theaters, stage/performer monitoring, drum fill monitoring, and large dance clubs.

The SB750zF is designed to be used with today's sophisticated digital signal processing to optimize the LF response. EAW's MX Series processors are recommended for the required crossover and equalization.

Six Year Warranty.

Dual 18 inch Subwoofer

See TABULAR DATA notes for details, half space = floor-mounted

CONFIGURATION

Subsystem		
	<i>Transducer</i>	<i>Loading</i>
SUB	2x 18 in cone	Vented
Operating Mode		
	<i>Amplifier Channels</i>	<i>External Signal Processing</i>
Single-amp	LF1/LF2	DSP w/1-way filter
Dual-amp	LF1, LF2	DSP w/1-way filter

PERFORMANCE ¹

Operating Range	27 Hz to 147 Hz	
Nominal Beamwidth		
Horz	360°	
Vert	360°	

Axial Sensitivity (SPL)		
LF1/LF2 (whole space)	96 dB	27 Hz to 147 Hz
(half space)	102 dB	27 Hz to 147 Hz

Input Impedance (ohms)		
	<i>Nominal</i>	<i>Minimum</i>
LF1/LF2	4	3.4 @ 27 Hz
LF1, LF2	8 (each)	6.7 @ 27 Hz (each)

High Pass Filter	
High Pass	=>20 Hz, 12 dB/octave Butterworth

Accelerated Life Test ²		
System	LF1/LF2 75 V	1400 W @ 4 ohm
	LF1, LF2 75 V (each)	700 W @ 8 ohm (each)
Transducer (AES)	1000 W (each)	

Calculated Axial Output Limit (SPL)		
	<i>Average</i>	<i>Peak</i>
LF1/LF2 (whole space)	128 dB	134 dB
(half space)	134 dB	140 dB

ORDERING DATA

<i>Description</i>	<i>Part Number</i>
SB750zF Dual 18 inch Subwoofer Black	997066
Optional Accessories	
Caster Pallet	255049
Spare Fly Clip Cables (set of 4)	255061
Fly Clip with Ring	0001386
Fly Clip with Hook	179001

¹ To achieve specified performance, the listed external signal processing with EAW-provided settings is required.

² For recommendations to select power amplifier size refer to : "HOW MUCH AMPLIFIER POWER DO I NEED?" on the EAW web site.

ENCLOSURE

Material	Baltic birch plywood
Finish	Wear resistant textured black paint
Grille	Powder-coated perforated steel

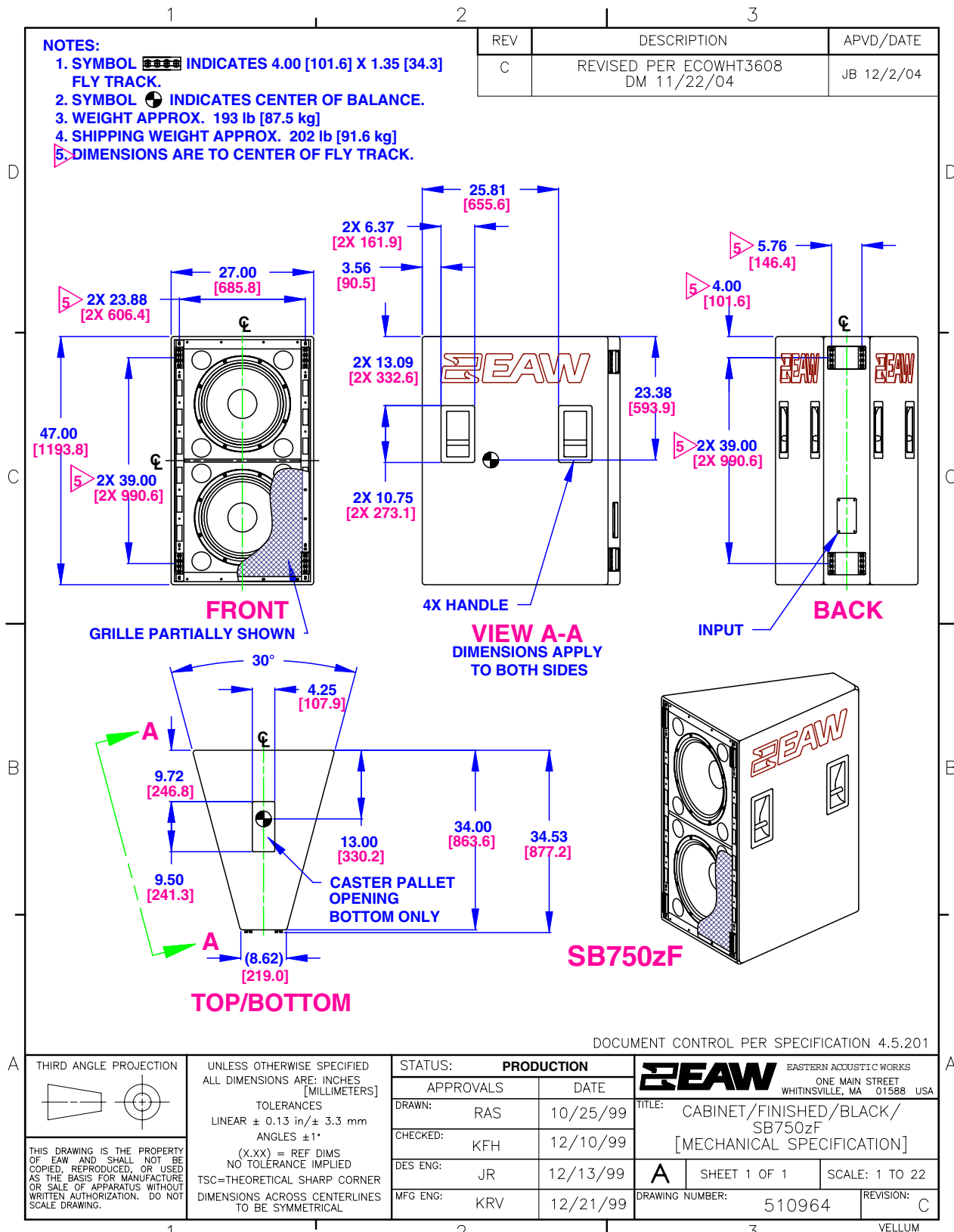

NOTE: This drawing has been reduced. Do not scale.

PERFORMANCE DATA

See *NOTES GRAPHIC DATA* for details

Frequency Response: Processed

LF1/2 Whole Space = green

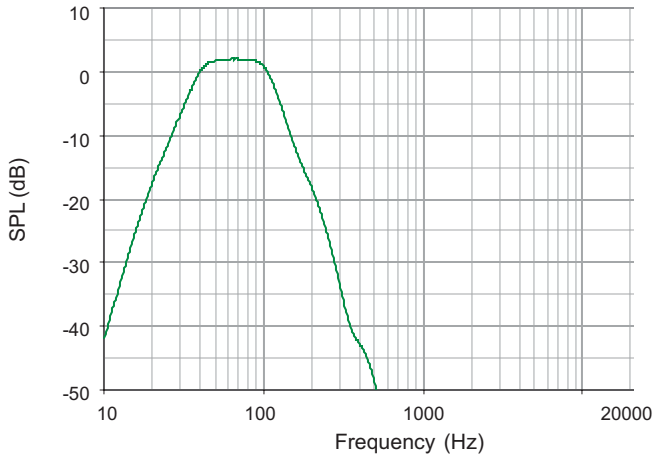

Frequency Response: Unprocessed

LF1/2 Whole Space = green

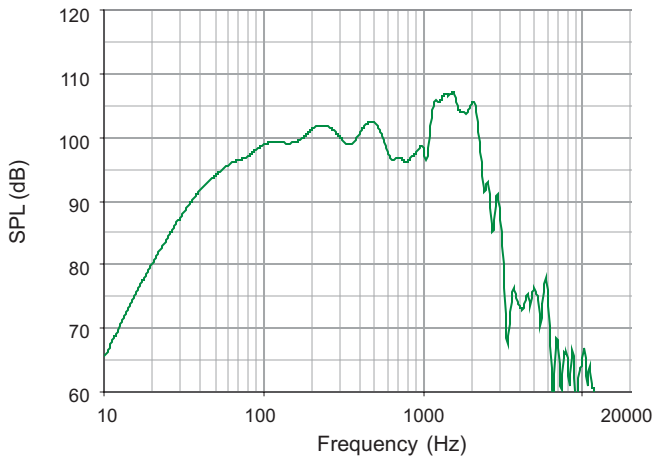

Frequency Response: Digital Signal Processor

LF = green

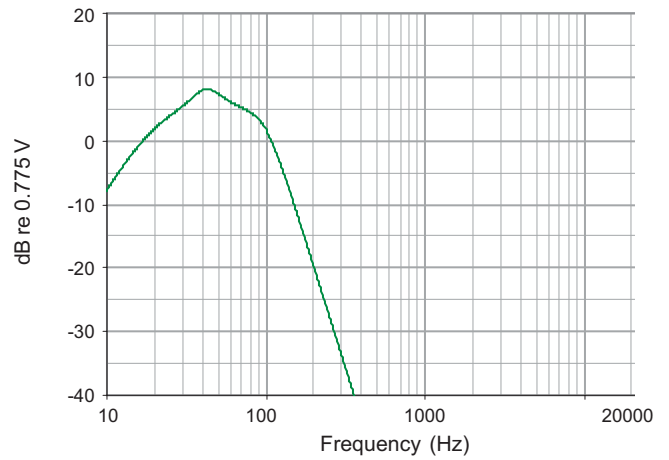

Impedance Magnitude

LF1/2 = green LF1 or LF 2 = orange

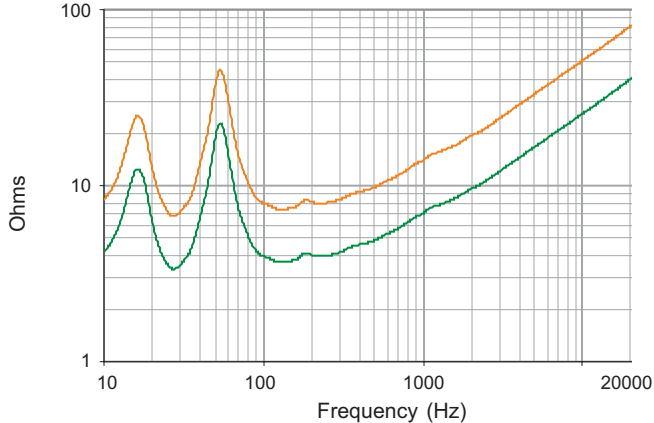

INPUT PANEL

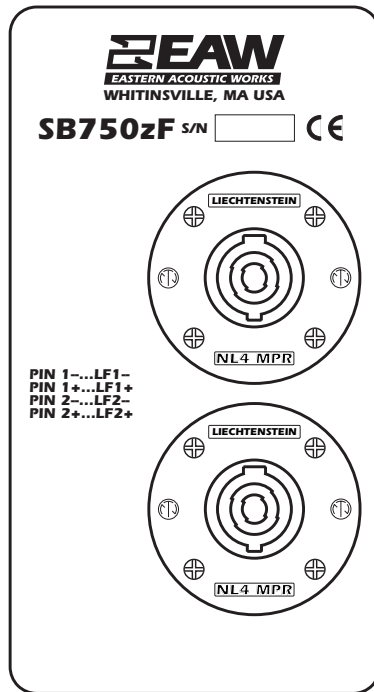

SIGNAL DIAGRAM

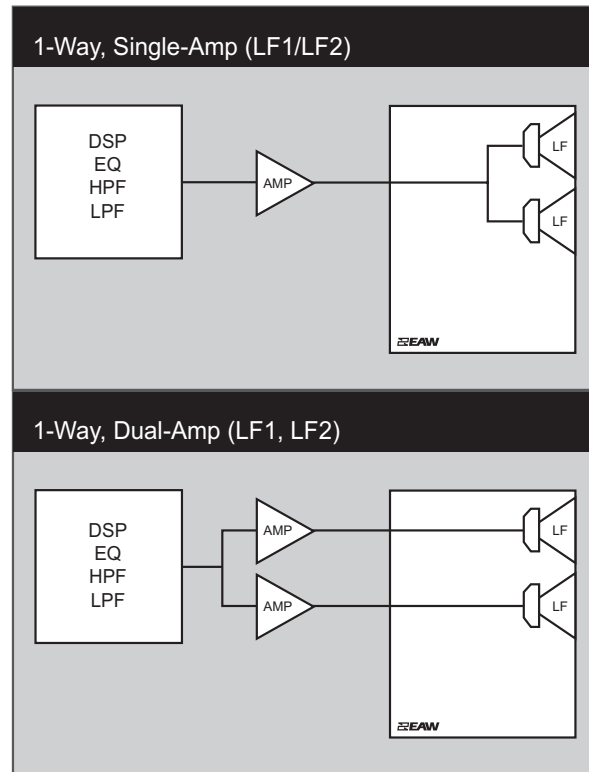

LEGEND

- DSP:** User-supplied Digital Signal Processor.
- HPF:** High Pass Filter for crossover or specified High Pass Filter.
- LPF:** Low Pass Filter for crossover.
- LF/MF/HF:** Low Frequency / Mid Frequency / High Frequency.
- AMP:** User-supplied Power Amplifier.
- XVR:** Passive LPFs, HPFs, and EQ integral to the loudspeaker.

NOTES

TABULAR DATA

1. **Measurement/Data Processing Systems:** Primary - FChart: proprietary EAW software; Secondary - Brüel & Kjær 2012.
2. **Microphone Systems:** Earthworks M30; Brüel & Kjær 4133
3. **Measurements:** Dual channel FFT; length: 32 768 samples; sample rate: 48 kHz; logarithmic sine wave sweep.
4. **Measurement System Qualification** (includes all uncertainties): SPL: accuracy +/-0.2 dB @ 1 kHz, precision +/-0.5 dB 20 Hz to 20 kHz, resolution 0.05 dB; Frequency: accuracy +/-1 %, precision +/-0.1 Hz, resolution the larger of 1.5 Hz or 1/48 octave; Time: accuracy +/-10.4 µs, precision +/-0.5 µs, resolution 10.4 µs; Angular: accuracy +/-1°, precision +/-0.5°, resolution 0.5°.
5. **Environment:** Measurements time-widowed and processed to eliminate room effects, approximating an anechoic environment. Data processed as anechoic or fractional space, as noted.
6. **Measurement Distance:** 7.46 m. Acoustic responses represent complex summation of the subsystems at 20 m. SPL is referenced to other distances using the Inverse Square Law.
7. **Volts:** Measured rms value of the test signal.
8. **Watts:** Per audio industry practice, "loudspeaker watts" are calculated as voltage squared divided by rated nominal impedance. Thus, these are not True Watt units of energy as defined by International Standard.
9. **SPL:** (Sound Pressure Level) Equivalent to the average level of a signal referenced to 0 dB SPL = 20 microPascals.
10. **Subsystem:** This lists the transducer(s) and their acoustic loading for each passband. Sub = Subwoofer, LF = Low Frequency, MF = Mid Frequency, HF = High Frequency.
11. **Operating Mode:** User selectable configurations. Between system elements, a comma (,) = separate amplifier channels; a slash (/) = single amplifier channel. DSP = Digital Signal Processor. **IMPORTANT:** To achieve the specified performance, the listed external signal processing must be used with EAW-provided settings.
12. **Operating Range:** Range where the processed Frequency Response stays within -10 dB SPL of the power averaged SPL within this range; measured on the geometric axis. Narrow band dips are accepted.
13. **Nominal Beamwidth:** Design angle for the -6 dB SPL points, referenced to 0 dB SPL as the highest level.
14. **Axial Sensitivity:** Power averaged SPL over the Operating Range with an input voltage that would produce 1 W at the nominal impedance; measured with no external processing on the geometric axis, referenced to 1 m.
15. **Nominal Impedance:** Selected 4, 8, or 16 ohm resistance such that the minimum impedance point is no more than 20% below this resistance over the Operating Range.
16. **High Pass Filter:** This helps protect the loudspeaker from excessive input signal levels at frequencies below the Operating Range.
17. **Accelerated Life Test:** System: Maximum test input voltage applied with an EIA-426B defined spectrum; measured with specified signal processing; Transducer: AES2-1984 R 1997.
18. **Calculated Axial Output Limit:** Highest average and peak SPLs possible during the Accelerated Life Test. The Peak SPL represents the 2:1 (6 dB) crest factor of the Life Test signal.

GRAPHIC DATA

1. **Resolution:** To remove insignificant fine details, 1/12 octave cepstral smoothing was applied to acoustic frequency responses and 1/3 octave cepstral smoothing was applied to the beamwidth and impedance data. Other graphs are plotted using raw data.
2. **Frequency Responses:** Variation in acoustic output level with frequency for a constant input signal. Processed: normalized to 0 dB SPL. Unprocessed inputs: 2 V (4 ohm nominal impedance), 2.83 V (8 ohm nominal impedance), or 4 V (16 ohm nominal impedance) referenced to a distance of 1 m.
3. **Processor Response:** The variation in output level with frequency for a constant input signal of 0.775 V = 0 dB reference.
4. **Impedance:** Variation in impedance magnitude, in ohms, with frequency without regard to voltage/current phase. This means the impedance values may not be used to calculate True Watts (see 8 above).