

***NEXT BASE***<sup>®</sup>

MODEL NO.  
**SDV37-SD**  
OPERATING INSTRUCTIONS

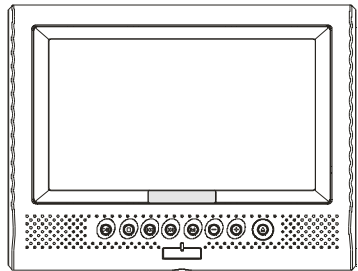

1. Read these instructions.
2. Keep these instructions.
3. Heed all warnings.
4. Follow all instructions.
5. Do not use this apparatus near water.
6. Clean only with dry cloth.
7. Do not block any ventilation openings. Install in accordance with the manufacturer's instructions.
8. Do not install near any heat sources such as radiators, heat registers, stoves, or other apparatus (Including amplifiers) that produce heat.
9. Do not defeat the safety purpose of the polarized or grounding-type plug. A polarized plug has two blades with one wider than the other. A grounding type plug has two blades and a third grounding prong. The wide blade or the third prong are provided for your safety. If the provided plug does not fit into your outlet, consult an electrician for replacement of the obsolete outlet.
10. Protect the power cord from being walked on or pinched particularly at plugs, convenience receptacles, and the point where they exit from the apparatus.
11. Only use attachments/accessories specified by the manufacturer.
12. Use only with the cart, stand, tripod, bracket, or table specified by the manufacturer, or sold with the apparatus. When a cart is used, use caution when moving the cart/apparatus combination to avoid injury from tip-over.



13. Unplug this apparatus during lightning storms or when unused for long periods of time.
14. Refer all servicing to qualified service personnel. Servicing is required when the apparatus has been damaged in any way, such as power-supply cord or plug is damaged, liquid has been spilled or objects have fallen into the apparatus, the apparatus has been exposed to rain or moisture, does not operate normally, or has been dropped.
15. To reduce the risk of fire or electric shock, do not expose this appliance to rain or moisture.
16. The Shock Hazard Marking and Associated Graphical Symbol is provided on the bottom panel of unit.
17. Apparatus shall not be exposed to dripping or splashing and no objects filled with liquids, shall be placed on the apparatus.

Thank you for purchasing this Portable DVD player. Please read this manual carefully before operating and reserve it for future reference. It will be helpful to you if you encounter any operational problem.

**WARNING:** TO REDUCE THE RISK OF FIRE OR ELECTRIC SHOCK, DO NOT EXPOSE THIS APPLIANCE TO RAIN OR MOISTURE, DRIPPING OR SPLASHING AND THAT NO OBJECTS FILLED WITH LIQUIDS, SUCH AS VASES, SHALL BE PLACED ON THE APPARATUS. DANGEROUS HIGH VOLTAGES ARE PRESENT INSIDE THE ENCLOSURE. DO NOT OPEN THE CABINET. REFER SERVICING TO QUALIFIED PERSONNEL ONLY.

**ATTENTION:** TO PREVENT ELECTRIC SHOCK, MATCH WIDE BLADE OF PLUG TO WIDE SLOT, FULLY INSERT.

**LASER:** This Digital Video Disc player employs a Laser System. To ensure proper use of this product, please read this owner's manual carefully and retain for future reference. Should the unit require maintenance, contact an authorized service location - see service procedure.

Use of controls, adjustments or the performance of procedures other than those specified may result in hazardous radiation exposure.

To prevent direct exposure to laser beam, do not try to open the enclosure.

Visible and invisible laser radiation when open and interlocks defeated.

**DO NOT STARE INTO BEAM.**

#### LASER

Type	Semiconductor laser GaAlAs
Wave length	650 nm/780nm
Output Power	5mW
Beam divergence	60degree

**CLASS 1  
LASER PRODUCT**

**WARNING:**

To reduce the risk of fire or electric shock, do not expose this appliance to rain or moisture.

**CAUTION:**

Use of controls or adjustments or performance of procedures those specified may result in hazardous radiation exposure.

**CAUTION****RISK OF ELECTRIC SHOCK. DO NOT OPEN**

To reduce the risk of electric shock, do not remove cover (Or back).  
No user serviceable parts inside. Refer servicing to qualified service personnel.



The lightning flash with arrowhead symbol, with in an equilateral triangle, is intended to alert user to the presence of uninsulated "dangerous voltage" within the product enclosure that may be of sufficient magnitude to constitute a risk of electric shock to persons.



The exclamation point within an equilateral triangle is intended to alert the user to the presence of important operating and maintenance (Servicing) instruction in the literature accompanying the appliance.

**CAUTION:**

INVISIBLE LASER RADIATION WHEN OPEN AND  
INTERLOCK FAILED OR DEFEATED.  
AVOID DIRECT EXPOSURE TO LASER BEAM.

**MACROVISION:** This product incorporates copyright protection technology that is protected by U.S. patents and other intellectual property rights. Use of this copyright protection technology must be authorized by Macrovision, and is intended for home and other limited viewing uses only unless otherwise authorized by Macrovision. Reverse engineering or disassembly is prohibited.

**FCC NOTICE:** This device complies with part 15 of the FCC Rules. Operation is subject of the following two conditions: (1) This device may not cause harmful interference, and (2) this device must accept any interference received, including interference that may cause undesired operation.

**DOLBY:** Manufactured under license from Dolby Laboratories. "Dolby" and the double-D symbol are trademarks of Dolby Laboratories.

**DivX:** This device incorporates copyright protection technology that is protected by DivX, Inc. DivX, DivX Certified and associated logos are trademarks of DivX, Inc and used under license.

**INTRODUCTION**

PRECAUTIONS.....	<b>1</b>
------------------	----------

TABLE OF CONTENTS....	<b>4</b>
-----------------------	----------

CAUTIONS ON USING THIS PLAYER.....	<b>6</b>
------------------------------------	----------

PRECAUTIONS FOR BATTERY PACK OPERATION .....	<b>8</b>
Operation of the battery pack .....	8
Storage.....	8
Service life and disposal .....	8

TYPES OF DISCS PLAYABLE ON THIS PLAYER.....	<b>9</b>
Marks indicated on DVDs.....	9
Playable formats .....	9
Disc structure .....	10

USING THESE OPERATING INSTRUCTIONS.....	<b>11</b>
---	-----------

**BEFORE USING**

CHECKING THE ACCESSORIES.....	<b>12</b>
-------------------------------	-----------

REMOTE CONTROL UNIT AND MAIN UNIT PREPARATIONS.....	<b>13</b>
---	-----------

Notes on using the remote control unit.....	13
Replacing the battery.....	13
Remote control unit operating range.....	14

**PARTS AND FUNCTIONS.....15**

Liquid crystal display.....	15
Main unit control section.....	15
Main unit left side.....	16
Main unit right panel.....	17
Main unit rear side.....	18
How to stand.....	18
Main unit bottom side.....	18
Remote control unit (Frequently used buttons).....	19
Remote control unit (Other buttons).....	20
Names of battery parts and their functions.....	21

**CONNECTING THE PLAYER TO OTHER DEVICES.....22**

Connecting to a TV.....	22
Connecting to a Dolby Digital/ DTS/ MPEG decoder or an amplifier with built-in decoder.....	23
Connecting to a digital amplifier that is not Dolby Digital/ DTS/ MPEG compatible.....	24
Connecting to active speaker systems.....	25
Connecting earphone.....	26

**USING THE BATTERY...27**

Recharging the battery pack.....	27
Notes for recharging.....	28
Attaching the battery pack to the player.....	28
AC power operation .....	29
Removing the battery pack from the player.....	29

**BASIC OPERATIONS**

TURNING ON THE POWER.....	<b>30</b>
---------------------------	-----------

PLAYBACK FUNCTIONS.....	<b>31</b>
-------------------------	-----------

Loading .....	31
Playing.....	32
If a menu screen appears.....	32
Stopping playback.....	33
Pausing playback.....	33
Returning to the previous chapter or track(DVDs, video CDs and CDs).....	34
Moving to the next chapter or track(DVDs, video CDs and CDs).....	34
Removing the disc.....	34

TURNING OFF THE POWER.....	<b>35</b>
----------------------------	-----------

**ADVANCED OPERATIONS**

ADVANCED FUNCTIONS.....	<b>36</b>
-------------------------	-----------

Searching for a specific scene... 36	36
Viewing in slow motion (DVDs and video CDs).....	36
Repeating DVDs, video CDs and CDs.....	36
Selecting angle (Multi-angle).....	36
Changing from AV OUT to AV IN.....	37
Playing a MP3 format disc and JPEG CD.....	37
Playing DivX files.....	38

**SETUP THE PLAYER**

GENERAL STEPS OF SETUP.....	39
-----------------------------	----

**SYSTEM SETUP**

TV SYSTEM.....	40
SCREEN SAVER.....	40
TV TYPE.....	41
PASSWORD.....	42
RATING.....	42
DEFAULT.....	42

**LANGUAGE SETUP**

OSD LANGUAGE.....	43
AUDIO LANGUAGE.....	43
SUBTITLE LANGUAGE.....	44
MENU LANGUAGE.....	44

**AUDIO SETUP**

AUDIO OUT.....	45
----------------	----

**VIDEO SETUP**

BRIGHTNESS.....	46
CONTRAST.....	46
HUE.....	47
SATURATION.....	47

**DIGITAL SETUP**

DYNAMIC RANGE.....	48
DivX (R)VOD.....	48

CAUTIONS ON USING..	<b>50</b>
Handling discs.....	50

TROUBLE SHOOTING..	<b>51</b>
--------------------	-----------

**Do not move the player during playback**

During playback, the disc spins at high speed. So do not lift or move the player. Doing so may damage the disc.

**Transporting the player**

When transporting the player be sure to remove the disc and turn off the power, then unplug the power cord .

**Place of installation**

Select a stable place near the TV or stereo system to which you are going to connect the player.

Do not place the player on top of a TV or color monitor. Install the player away from cassette decks or other devices which are easily affected by magnetic forces.

**Do not place objects on top of the player**

Do not place any objects on top of the player.

**Turn off the power when not using the player**

If the player is connected to your TV but not in use then switch the power off.

This will prevent interference with your normal TV picture.

Noise problems may also be experienced if used near a radio.

**Special note regarding use of player in vehicles**

- We strongly advise against using the player while driving.
- Most countries and states have laws which prohibit or severely restrict the use of the player in vehicles while driving.
- Do not leave the player or the battery pack in places where the temperature is extremely low (About -10°C or lower) or extremely high (About 60°C or higher), such as inside the passenger cabin or trunk in midsummer. Doing so may warp the outer case or reduce the performance or quality of the battery pack.

**When carrying on planes**

Heed the airline company's rules.

**When carrying in hospitals**

Heed the hospital's rules.



### When using with car power cable in cars

Please turn on the engine and then connect with the car power cable for using.

### Cleaning the player

Normally clean the player with a soft, dry cloth. For tough dirt, apply some neutral detergent diluted in 5 to 6 parts water to a soft cloth, wring out thoroughly. Wipe off the dirt, then wipe the player with a dry cloth. Note that alcohol, thinner, benzene, insecticides, etc., may cause the print or coating to peel off. Also avoid leaving rubber or plastic products in contact with the player for long periods of time, as this may damage the cabinet. When using chemically treated cloths, read the cloth's instructions carefully. Always unplug the power cord from the power outlet before cleaning the player.

To clean dirt off the liquid crystal display, wipe the display gently with a soft, dry cloth (Such as an eyeglass cleaning cloth). Note that leaving water droplets on the display for long periods of time may result in discoloration or stains. For tough dirt, use a commercially available liquid crystal display cleaner.

### Copyrights

Unauthorized duplication, broadcast, public performance or rental of discs is prohibited by law.

### Operation of the battery pack

- Charge the battery pack fully before using it for the first time.
- When the surrounding temperature is high, the battery pack may sometimes be unusable due to activation of protection circuitry.
- When the portable DVD player is powered from the battery pack and if the player has not been operated for about 10 minutes with the power switched on, the player will turn off automatically. (Auto power off)  
The battery pack and the portable DVD player become hot during use. This is not malfunction.
- When the battery pack is not to be used for a long period, be sure to remove it from the portable DVD player. If the battery pack is left attached, continual flow of weak current renders it overdischarged and eventually unusable even when you try to charge it later.
- If the portable DVD player is switched on while the battery pack is not fully charged, the operation may sometimes be unstable. Be sure to charge the battery pack fully before use.

### Storage

- The battery pack should be stored under an surrounding temperature between 15°C and 25°C. Avoid storing it under extremely low temperatures, in a place with high temperature and high humidity or in a place subject to

soot, etc..

- When the battery pack is stored for a long period, at least once a year it is recommended to discharge it fully on the portable DVD player, recharge it fully and store it again.



### Service life and disposal

- When the charging time or available operation time becomes extremely short, the battery may reach the end of its life. The battery pack can be used for about 300 cycles of recharging and operations.
- To dispose of a used battery pack, wrap a piece of tape around the terminal section and treat it in compliance with your local regulations.

### Caution:

- Danger of explosion if battery is incorrectly replaced.  
Replace only with the same or equivalent type.

- The discs listed on the table below can be played on this player without an adapter.
- The marks shown on the table below are indicated on the disc's label, package or jacket.





Types of playable discs and their marks	Diameter/Playable sides	Playback time
DVD-Video disc 	DVD video 12cm/single-sided 1 layer 2 layer 12cm/double-sided 1 layer 2 layer	Playback time (MPEG 2 format) 133 minutes (4.7GB) 242 minutes (8.5GB) 266 minutes (9.4GB) 484 minutes (17GB)
CD 	CD 12 cm/single-sided	74 minutes

**Note:**

Do not support 8cm discs.

**Marks indicated on DVDs**

DVD discs or packages include the marks shown below. These marks indicate the type of video or audio signals recorded on the disc and the functions that can be used.

Mark	Meaning
	Indicates the number of audio tracks.
	Indicates the number of angles.
	Indicates the selectable picture aspect ratio.
	Indicates the playable region number.

**Playable formats**

The unit is able to play most audio/video files such as:

PICTURE: JPEG

AUDIO: MP3, WMA

VIDEO: DAT, VOB, MPEG2, MPEG4 (AVI, DIV)

## Disc structure

CDs are divided in units called tracks. (Generally one track corresponds to one song. Tracks are sometimes further divided into indexes.)



DVDs are divided in units called titles, which are further divided in chapters. They also include menu screens that do not belong to any title. With movies, normally one movie corresponds to one title. On karaoke discs, one song corresponds to one title. Some discs are not divided in this way, however, so be careful when using the search and programming functions.

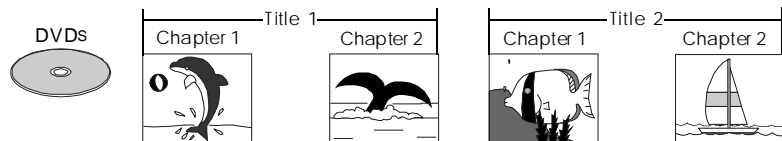

Be sure to read the operating instructions carefully before using the player. It can ensure you taking maximum advantage of all functions of this player.

When this player is connected to a TV or AV amplifier, the setup screen should be displayed. Choose the various corresponding settings according to the connected equipment.

With DVDs it is possible to use setup to change the subtitle and audio languages and select the desired sound mode among multiple sound tracks.

In order to take full advantage of functions of this player, be sure to store this OPERATING INSTRUCTIONS in an accessible place.

After unpacking, check that all the accessories listed below are included.

AC/DC adapter



AV cable

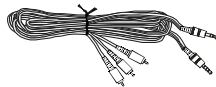

Ear phone



Car power cable

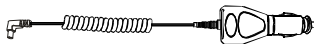

Card-type remote control unit

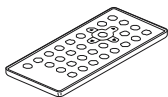

Operating instructions (This manual)



Soft carrying bag

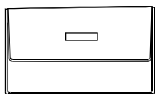

Accessories bag



Battery pack

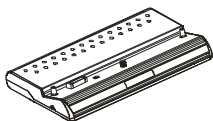

Car bag



NOTES: Actual products' appearance might vary slightly from the pictures shown.

## Notes on using the remote control unit

- Do not drop or step on the remote control unit or subject it to shocks. Doing so may damage it.
- Note that the remote control unit may not work if there are obstacles between it and the remote sensor.
- Do not expose the remote sensor to strong light. Doing so may make operation impossible.
- Use the remote control unit within the specified operating range.

## Replacing the battery

- 1 Insert your finger nails into A and B on the diagram below, press A according to the direction, then pull out the battery holder.

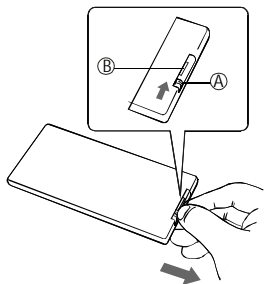

- 2 Remove the old battery, then insert the new battery into the battery holder with the + side facing upwards.

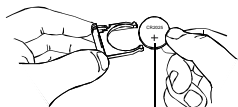

Lithium battery (CR2025)

- 3 Fit the battery holder back to its place.

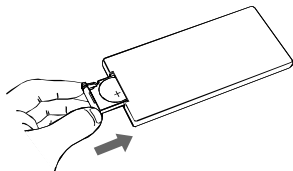
**Note:**

To prevent leakage of fluid from the lithium battery, remove the battery when not using the remote control unit for long periods of time (One month or more). If the battery leaks fluid, carefully wipe it out of the battery case, then change to a new lithium battery.

## Remote control unit operating range

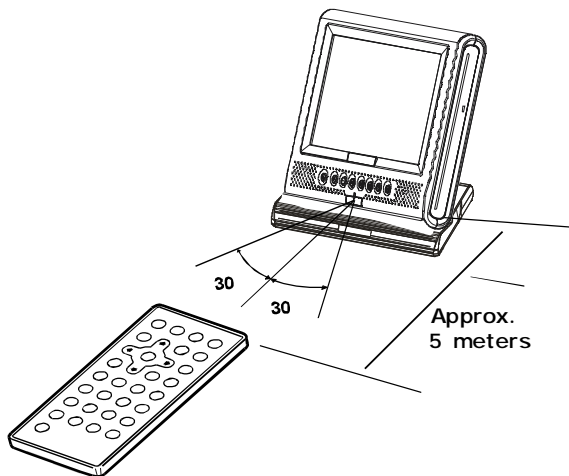

The remote control unit can operate within a distance of approximately 5 meters.

### Note:

Most of the player's operations can be done by using the remote control unit. Some operations, however, can only be done by using the main unit buttons.



## Liquid crystal display

The portable DVD player is equipped with a liquid crystal display.

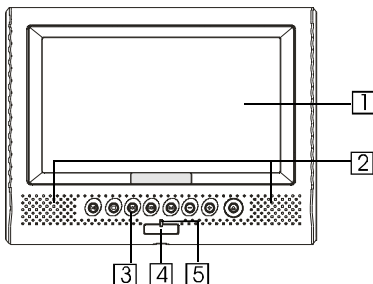

### 1 Liquid crystal display

### 2 Speakers

### 3 Control section

Control buttons.

### 4 Remote control sensor

The remote control signals are received from here.

### 5 Power indicator

Off: No power connection.

Red: The player is set to standby mode.

Blue: The player is on. Turn on the power using ON button on the main unit or the STANDBY button on the remote control unit.

## Main unit control section

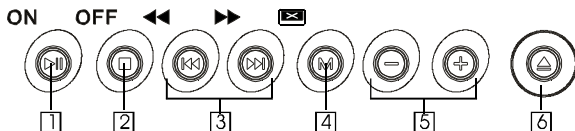

**1 Play/pause button**

Press it to play. When pressing during playback mode, pause mode is set. Press it again to resume playback.

**Hold it for about 1.5 seconds to power on the unit.**

**2 Stop /off button**

Press it to stop playback.

**Hold it for about 1.5 seconds to turn off the unit (Standby status).**

**3 Previous/next buttons**

Use them to locate at the beginning of the previous/next track or chapter.

**Hold them for about 1.5 seconds during playback to backward/forward the playing speed through X2, X4, X8, X20.**

**4 Mode button**

Use +/- key to adjust display mode.

BRIGHTNESS: Level 0 to 8.

COLOR: Level 0 to 8.

TFT MODE: Switch screen between 16:9 and 4:3.

VIEW MODE: Switch screen between reverse and observe.

AV INPUT/OUTPUT: Switch the AV function between input and output.

Hold the button about 1.5 seconds to turn off the display and press it to resume.

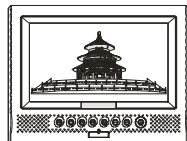

observe

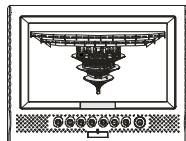

reverse

**5 -/+ buttons**

Press them to adjust display MODE.

**6 OPEN button**

Press it to pop out the disc.

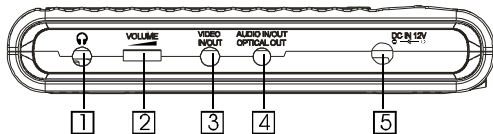
**Main unit left side**

**1 Earphone jack**

For connecting a stereo earphone or an amplifier.

**2 Volume control**

Use it to adjust the volume of the speakers or earphone.

**3 Video in/out jack**

Input or output video signals to connected device by setting AV IN/OUT mode value. The included AV cable is connected here.

**4 Audio in/out and optical output jack**

Input or output audio signals to connected device by setting AV IN/OUT mode value. Output optical audio signals to connected device. The included AV cable or optical digital cable is connected here.

**5 DC in**

Connect the included AC adapter here.

**Main unit right panel****1 Loader status indicator LED**

Indicate loader status.

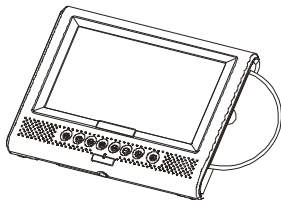
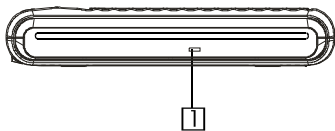

## Main unit rear side

**1 Support**

The unit can stand with this device.

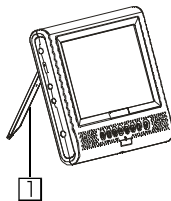
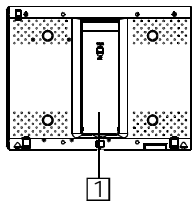

## How to stand

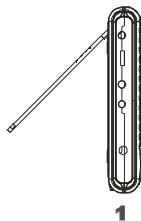
**1 Pull out the support.****2 Draw out the support to a proper position .****3 Pull down the button to lock it.**

## Main unit bottom side

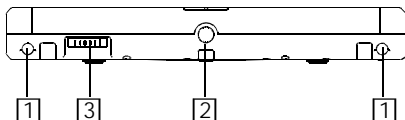
**1 Hole for Battery Pack****2 Nut for Battery Pack****3 Battery connector****Note:**

Remember to insert back the rubber cover to BATTERY CONNECTOR after using the battery pack.

## Remote control unit (Frequently used buttons)

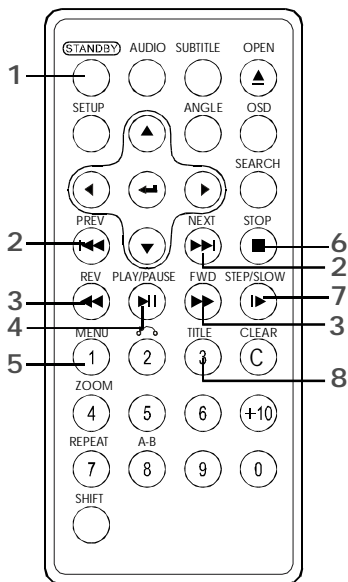

▶▶ : Forward direction

◀◀ : Backward direction

**4 PLAY/PAUSE button** (▶||)

Use this button to play or pause playback.

**5 MENU button**

Press this button to display the DVD's menu screen.

**6 STOP button** (■)

Press this button to stop playback.

**7 STEP/SLOW button** (▶|)

Press this button to slow playback at 1/2, 1/4, 1/6, 1/7 speed. If at pause status, press this button to play step-by-step.

**8 TITLE button**

Press this button to display the DVD's title.

**1 STANDBY button**

Press this button to turn on or off the power.

**2 PREVIOUS/NEXT button** (◀◀ and ▶▶)

Use these buttons to search for the beginnings of tracks or chapters.

◀◀ : Backward direction

▶▶ : Forward direction

**3 Scan buttons** (◀◀ and ▶▶)

Use these buttons to backward or forward the playing speed.

## Remote control unit (Other buttons)

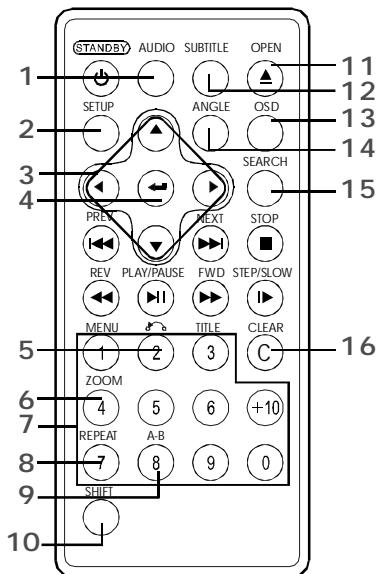
**1 AUDIO button**

Press this button to switch the audio language.

**2 SETUP button**

Press this button to display setup screen when at stop status.

**3 Cursor buttons**

Use these buttons to move the cursor up, down, left and right when selecting setting items.

**4 ENTER button**

Press it to enter/confirm setting item.

**5 RETURN button**

Press it to return back to the previous item.

(Only for VCD, PBC on)

**6 ZOOM**

Zoom the picture on screen.

**7 Number buttons**

Press these buttons to input numbers. Pressing the SHIFT button to switch from function to number if necessary.

**8 REPEAT button**

For DVDs, use this button to play titles or chapters repeatedly. For CDs, use this button to play tracks or the entire disc repeatedly.

**9 A-B REPEAT button**

Press this button during playback to set two points and play the section between them repeatedly.

**10 SHIFT button**

Press the shift button to switch number & function. (Default: function)

**11 OPEN**

Pop out disc.

**12 SUBTITLE button**

Press it to switch the DVD's subtitle language.

**13 OSD button**

Press this button to display the disc information.

**14 ANGLE button**

Press it to switch angle.

**15 SEARCH button**

Locate a title/ chapter/ time and play.

**16 CLEAR button**

Clear the numbers inputted before.

## Names of battery parts and their functions

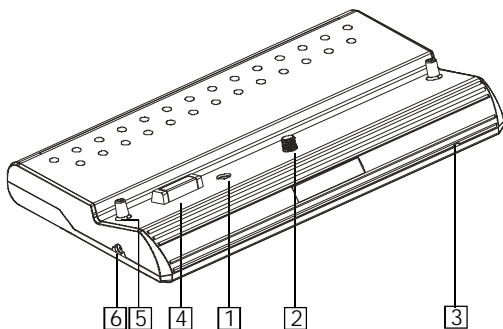
**1 DC IN connector**

Connect the power adapter to recharge(AC/DC adapter).

**2 Battery knob**

Twist it to tighten/detach the battery pack.

**3 Battery indicator LED**

When the battery is discharging, LED is off.

When recharging the battery, LED is red.

When the LED turns from RED to off, means finishing recharge.

**4 Player terminals**

Supply power to the player.

**CAUTION:**

Do not short-circuit the terminals.

**5 Fix pole**

Fix the battery to the player when installing battery.

**6 DC OUT (Non-standard jack)**

Output DC 7.4/7.2V. Especially for supplying power to TV Tuner Box (Optional accessory).

**Before connecting**

Turn off the power of the player and the devices to be connected.

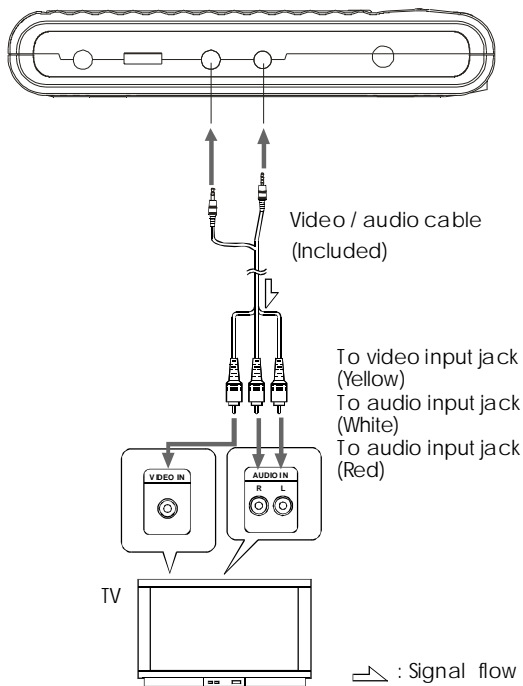
**Connecting to a TV**



### Connecting to a Dolby Digital / DTS / MPEG decoder or an amplifier with built-in decoder

With this player, you can enjoy powerful Dolby Digital, DTS or MPEG sound. Output the digital signals from the player's digital output to a decoder or amplifier with built-in decoder.

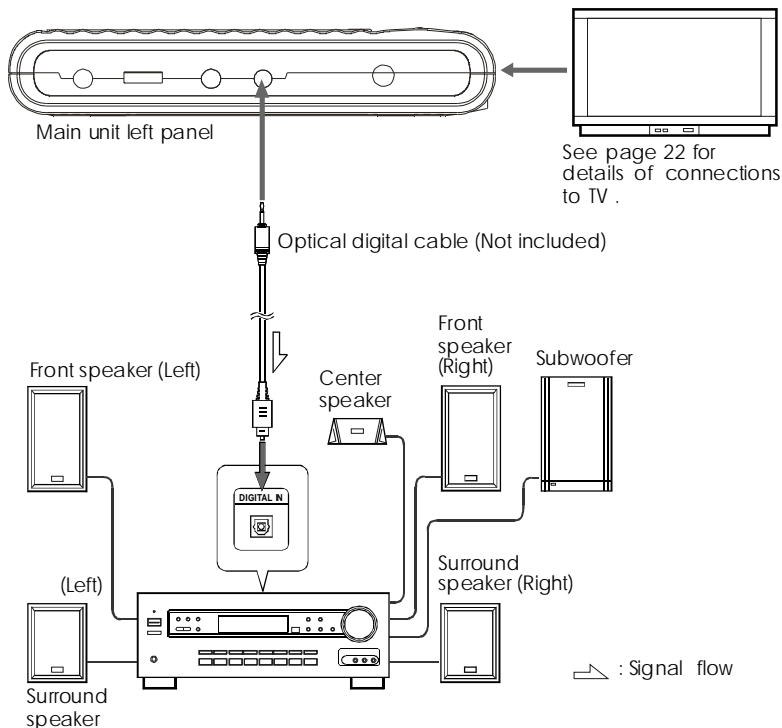

#### Hint:

For a compatible decoder or amplifier, 5 speakers (Front left/right, center and surround left/right) and a subwoofer are required to enjoy Dolby Digital /DTS 5.1-channel sound.

**Connecting to a digital amplifier that is not Dolby Digital / DTS / MPEG compatible**

Output the digital signals from the player's digital output to a digital amplifier that is not Doby/DTS/MPEG compatible.

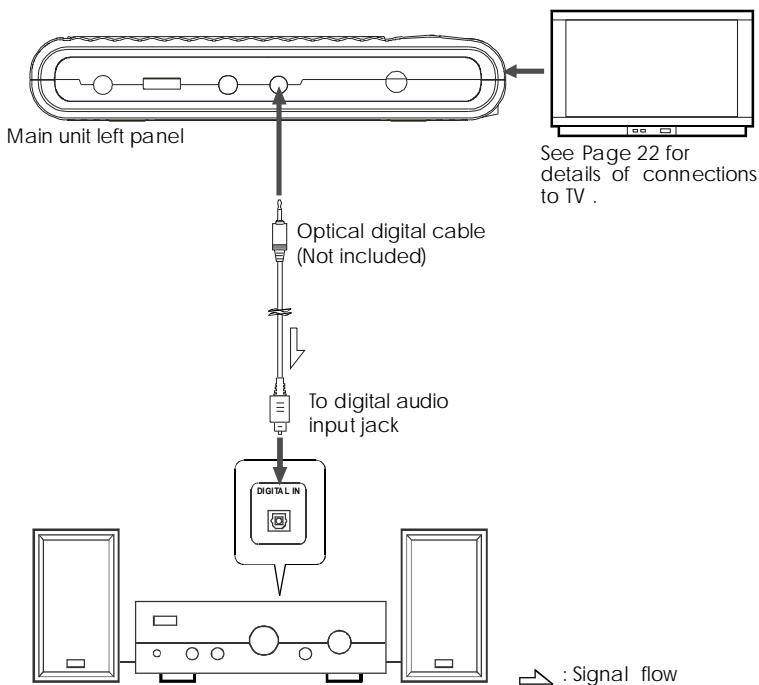
**Notes:**

- Carefully check the player's digital output settings before connecting the player to an amplifier equipped with a digital audio input jack which is not Dolby Digital / DTS / MPEG compatible.

**Do not play DVDs when the audio settings are not correct. Or may cause strong noise and damage your speakers.**

Connecting to active speaker systems

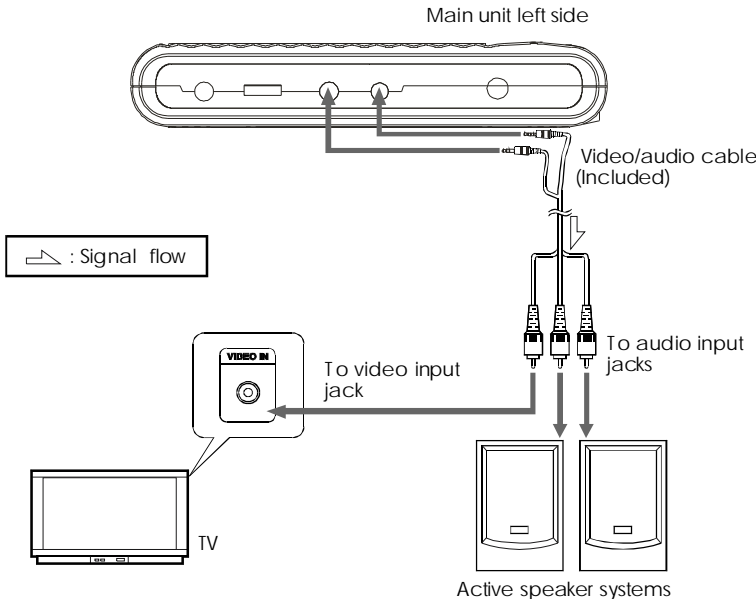

### Connecting earphone

Connect the earphone's plug securely to the EARPHONE JACK on the player. To listen to music through the earphone, first use the VOLUME CONTROL on the left side of the main unit to lower the volume to the minimum level, then adjust the volume to comfortable level. Be careful not to set the volume to too high level when using earphone.

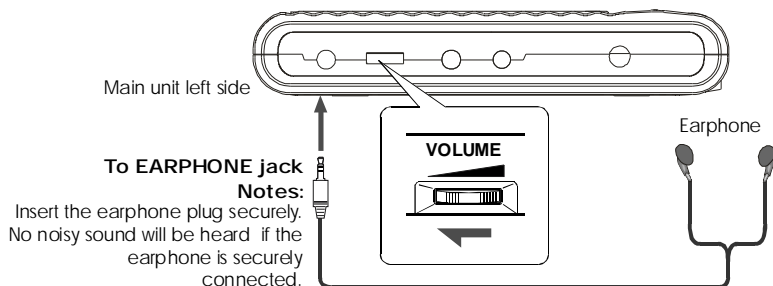

#### Note:

It is impossible to hear the sound of DTS-compatible DVDs over earphone. Strong noise will be produced when DTS discs are played. So do not listen to such discs through earphone.

### Recharging the battery pack

Recharging the battery pack as described below.

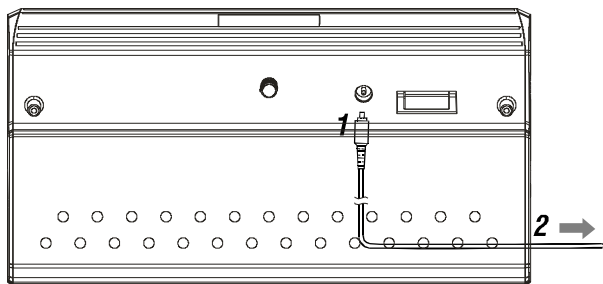

**1** Connect the DC output plug of AC adapter to the battery pack.

**2** Connect the AC adapter to the power outlet.

- When recharging starts, the recharge LED lights in red.
- The recharge LED turns off when recharging completes. Remove the power cord from battery pack.
- Recharging usually completes in about 4~5 hours.

The battery pack can be used for about 300 cycles of recharging and operations, though this is variable depending on the operating conditions.

Charge the battery pack fully before using it for the first time.

#### CAUTION

- Place the battery pack and AC adapter on a flat surface for recharging.
- Do not short-circuit the terminals of the battery pack and AC adapter.

#### Notes:

- The battery charger(AC adapter) is compatible with supply voltage between 100 and 240 V AC and can be used universally.
- When you want to use it on an overseas travel, however, be sure to prepare a power plug adapter matching the local power outlet.

### Notes for recharging

- When the battery pack is hot, it may take longer time than usual for recharging or may sometimes be unable to be recharged. Wait for the battery pack to cool down before retrying recharging.
- If the recharge LED can not be lit, check whether the AC adapter and battery pack are connected firmly to have perfect contact.
- To protect the battery pack, do not recharge a fully charged battery pack repeatedly. Repeated overcharging may deteriorate the battery performance.
- The battery pack becomes hot after recharging, but this is not malfunction.
- The battery pack may not be recharged fully if recharging at a hot place. Do not recharge it under very hot environment, it may cause explosion.
- The surrounding temperature during recharging affects the recharge efficiency. Recharging is in the most efficient state from 10°C to 30°C. Recharge the battery pack at a place within this temperature range whenever possible.

### Attaching the battery pack to the player

Attach the battery pack to the player as described below.



#### 1 Attach the battery pack to the unit.

- #### 2 Align the guide hole of the player with the guide rod on the battery pack. Turn the battery knob clockwise until the battery pack is tighten with the player.

#### 3 Now the player can be operated.

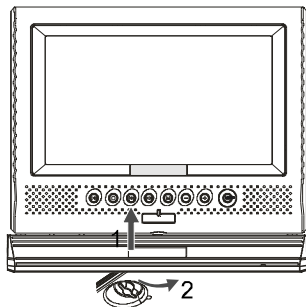
- If the battery pack is fully recharged, the player can play DVDs continuously for over 3 hours.



- If the power is switched on while the battery pack is not fully charged, the player operation may sometimes become unstable. Be sure to charge the battery pack fully before using.
- The battery pack is being recharged slowly while the player is playing with AC adapter connected.
- The battery pack is being recharged as recharged separately while the player is at STAND BY mode with AC adapter connected.
- After connecting the battery pack and power on, press OSD button on remote control at PLAY, PAUSE or STOP status to show symbol "  ". This symbol indicates the capability of the battery pack.
- While the battery pack has lower capacity, "  " will be flashed to remind you.

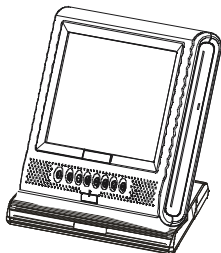

### AC power operation

- 1** Connect the DC output plug of the AC adapter to the DC IN jack on the player.
- 2** Connect the AC adapter to a power outlet.  
Now the player can be operated.

#### CAUTION:

Be sure to use the AC adapter provided with the player.  
Before inserting or removing the DC output plug of the AC adapter, always be sure to turn off the power of the portable DVD player.

### Removing the battery pack from the player

The battery pack can be removed from the player as described below.

- 1** Turn off the power of the player.
- 2** Turn the battery knob anti-clockwise to remove battery pack.

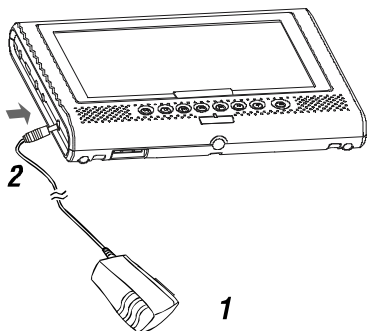

## Main unit (Front panel)

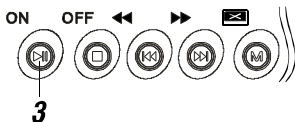

## Remote control unit

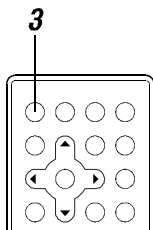

**1** Connect the AC adapter to a power outlet.

**2** Connect the DC output plug of the adapter to the DC input jack on the main unit.

**3** Keep pressing the ON button on the main unit for about 1.5 seconds.

■ The power LED is lit blue.  
The player can be used now.

■ At standby mode (When the power LED is lit red), the power can also be turned on by pressing the standby button on the remote control unit.

## Hint:

The included AC adapter is compatible with voltage from 100 to 240 V. You can use it on trips overseas.

Note that you need a converter plug (Available in stores) suited for the region in which you are travelling.

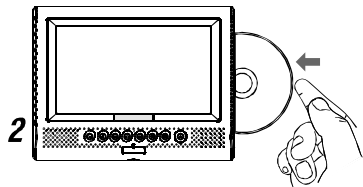
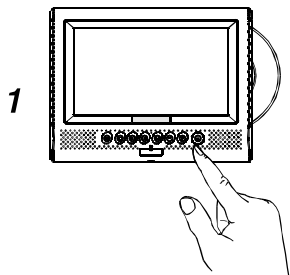

**Loading****1 Press OPEN button to open.**

The disc will go out as figure 1 shows. If no disc there then nothing happens.

**2 Push the disc into disc window and the disc will be slotted in automatically.****Notes:**

- Set the disc securely. Failure to set it securely could result in damage.
- Do not use cracked or warped discs. Doing so could result in damage.
- Push single-sided DVDs or CDs in with the label (Printed) side facing upwards. For double-sided DVDs, check each side carefully, then push the disc in securely.
- For CDs or one-sided DVDs, you do not have to worry about touching the label (Printed) side of the disc with your fingers. Since two-sided DVDs, however, have signals recorded on both sides, be careful not to scratch them when removing them from the player.

**3 The player starts loading.**

## Playing

### 1 Load the disc.

- One of the following messages appears on the screen:  
DVD, VCD, CD.
- For some discs, playback starts automatically when the disc is slotted in.
- For the disc which had been programmed and stored in memories, playback starts automatically in the programmed order.

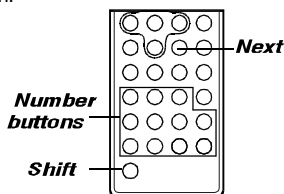

### 2 Press the play/pause button.

- Playback starts.
- For some discs, a menu screen appears. For video CDs, they will be played according to the instructions on the disc's menu screen which are called PBC (Playback control).

#### Hint:

- For video CDs, it is also possible to play a disc without displaying the menu screen. For example, press 1 ( Number button) while at STOP mode to play track 1.
- For CDs, in order to save power, the screen display will be closed automatically if no button is pressed for one minute during playing. Press any button to wake it up.

## If a menu screen appears

For DVDs with menu screen or video CDs with playback control (PBC), a menu screen appears.

### DVD

Use the cursor buttons (▲/▼/◀/▶) to select the item, then press the ENTER button.

In order to use the number buttons on the remote control unit to select the item, first press the SHIFT button until NUMBER is displayed on screen, then press number buttons to select the item.

## Video CD

Select your preferred item by pressing the **number buttons** after pressing the **SHIFT** button to switch to display NUMBER on screen.

### To display the menu screen

The way in which the menu screen is displayed differs from disc to disc. Press the MENU and TITLE buttons during playback of DVDs, the RETURN button during PBC playback of video Cds. For details, refer to the documentation included with the disc.

## Stopping playback

Press the STOP button. Playback will be stopped.

Resume function (DVDs and Video CDs, except VCD2.0 with PBC function on):

After the STOP button is pressed, press the PLAY button. Playback will start from the position at where it was stopped. If the disc is removed or press the STOP button again, the resume function will be cancelled.

### Note:

- For some discs, playback may not start from the position at where it was stopped.

## Pausing playback

Press the PLAY/PAUSE button to pause playback.

Press this button again to resume playback.

**Returning to the previous chapter or track(DVDs, video CDs and CDs)**

Press the PREVIOUS button during playback.

After pressing the PREVIOUS button, playback returns to the beginning of the previous chapter or track.

**Moving to the next chapter or track(DVDS, video CDs and CDs)**

Press the NEXT button during playback.

After pressing the NEXT button, playback moves forward to the beginning of the next chapter or track.

**Removing the disc**

- 1 Press the STOP button.
- 2 Press ▲ to pop out the disc.
- 3 Remove the disc.

**Note:**

For CDs or one-sided DVDs, you do not have to worry about touching the label (Printed) side of the disc with your fingers. Two-sided DVDs, however, have signals recorded on both sides. So be careful not to scratch them when removing them from the player.

- 1 When the power is on, press OFF and hold it for about 1.5S.  
The power LED becomes red and the standby mode is set.  
The power can also be turned off by pressing the STANDBY button on the remote control unit.
- 2 Unplug the power cord from the power outlet.
- 3 Disconnect the AC adapter from the player's DC input jack.

**CAUTION:**

When connecting the player to an external TV monitor, please make sure that (For better audio and visual performance) you switch/adjust the "TV system" (Marked  ) to the corresponding one.

Example: Change from NTSC (Default setting) to PAL as the SETUP MENU shows below:

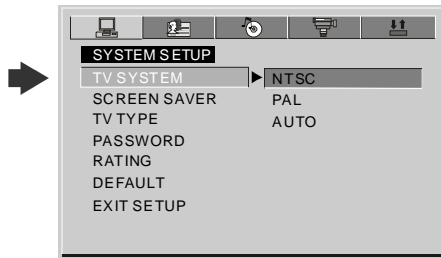
**Note:**

Please turn the player to the correct " TV system " before changing from " AV OUTPUT " to " AV INPUT " , or you can only see the black and white picture.

**Searching for a specific scene**

- 1** Press the SEARCH button.
- 2** Press the number button to input specific time or title/chapter.
- 3** Press the PLAY button or ENTER button. Playback starts from the specified position.

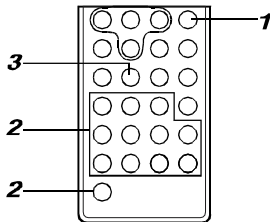

**Viewing in slow motion (DVDs and video CDs)**

Press the SLOW button during playback. The playback speed changes to 1/2, 1/3, 1/4 or 1/5, 1/6, 1/7 of the normal speed.

**Repeating DVDs, video CDs and CDs**

**Repeat a Title, Chapter, or Track:**

Press the REPEAT button.

Select the title, chapter, or track you want to repeat.

**Repeat a section between point A and B:**

During playback, press A-B button on the remote control unit at the starting point of the section you want to repeat. (Point A)

Press A-B button again at the ending point of the section you want to repeat. (Point B)

The repeating starts.

Press A-B button again to cancel the A-B repeat function.

**Selecting angle (Multi-angle)**

Press the ANGLE button while playing a scene with multiple angles.

If your DVD disc is not recorded with multiple angles, press ANGLE button will not function.

### Changing from AV OUT to AV IN

You can change the player from AV OUT(Output AV signal to TV, etc) to AV IN(Input AV signal from other device)and use it as a TFT Monitor. The default setting is AV OUT.

1 Press MODE button on main unit and switch LCD mode to AV IN/OUT.

2 Press + or - button to switch between AV OUT and AV IN.

#### Note:

Avoid to input AV signals from AV JACK when the player is set to AV OUT, or interference will be caused to affect current playback and lower down playing quality.

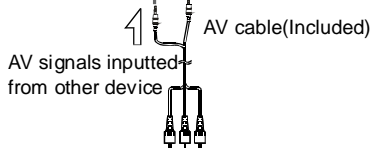
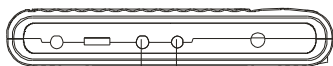

### Playing a MP3 format disc and JPEG CD

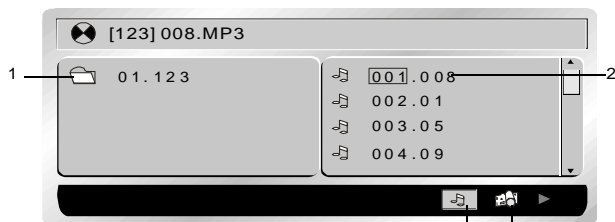

1. **Folder**
2. **Files**
3. **MP3 ICON**
4. **JPEG ICON**

- Use to move the cursor to a folder, a file, MP3 ICON or JPEG ICON.
- In order to play Mp3 files, move the cursor to MP3 ICON and press ENTER button.  
In order to play JPEG files, move the cursor to JPEG ICON and press ENTER button.
- Choose the desired file and press ENTER to play.
- Press A-B button to have A-B REPEAT function; press REPEAT button to switch repeat mode(REP1, REP DIR, REP ALL, REP OFF).  
REP1 means repeating the track; REP DIR means repeating the folder; REP ALL means repeating the whole disc.

## Playing DivX files

Your player is an Official DivX Certified product that plays DivX.5, DivX.4, DivX.3, and DivX.VOD video content, in compliance with DivX Certified technical requirements.

### NOTE:

To guarantee playback of DivX files the audio must be mp3 format. DivX Certified devices can play any interleaved mp3 audio at any bitrate, both CBR and VBR. The audio must be sampled at standard frequencies, such as 32 kHz, 44.1 kHz, and 48 kHz, and must conform to the AVI file specification. Apart from MP3, the audio formats recognised by your player are MPEG layer 1/2, AC3, DTS, PCM. Formats such as AAC and Ogg Vorbis are not supported by this player.

1. Turn on the player.
2. Push the disc into the player.
3. A menu appears on the screen. Select a folder using the **↑** and **↓** buttons on the remote control, then press **←** to see the folder's contents.

### NOTE:

When there are music, images and DivX files contained on one disc, press several times the **←** button to access the Play type at the bottom of the screen, then use the **←** or **→** button to select the DivX icon and press **←** to confirm.

4. Select a file using the **↑** and **↓** buttons on the remote control.

### NOTE:

To go back to the folder list, press **←**.

5. Press **▶** to start playback.
6. Press **STOP** ■ to stop playback.

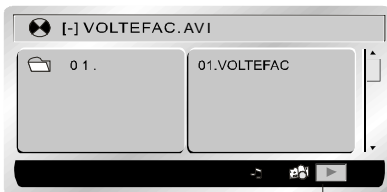

DivX play icons



**GENERAL STEPS OF SETUP**

1 Press the **SETUP** button on the remote control, the main setup menu appears.

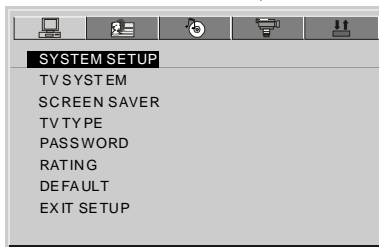

2 Press the **LEFT** and **RIGHT** buttons to highlight the icon of the desired page, then press the **DOWN** or **UP** button to activate that page.

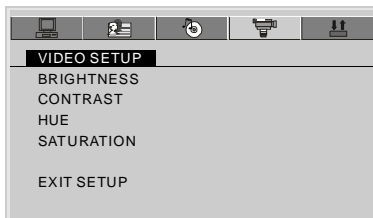

3 Press the **DOWN** button to highlight the desired option. Press **ENTER** or **RIGHT** to select the choices of that option appear.

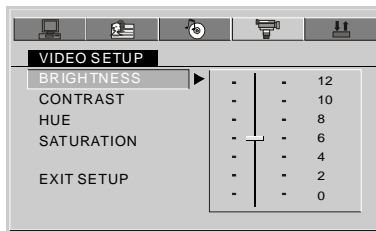

4 Press **LEFT/RIGHT/UP/DOWN** buttons to highlight the **EXIT SETUP** option, then press **ENTER** or **SETUP** again to exit **SETUP MENU**.

**NOTE:**

The pressing of the following buttons will turn off the setup menu, and the choices that have been changed will be saved: **Subtitle, Title, Return, Stop, Play/Pause, Step, Next, Prev, Zoom, Program, Repeat, Angle.**

The system setup options are illustrated below:

## TV SYSTEM

If you want to connect the player to a TV, please choose a correct TV system first.

- AUTO: Choose this setting if your DVD player is connected to a multi-system TV.
- NTSC: Choose this setting if your DVD player is connected to a NTSC TV.
- PAL: Choose this setting if your DVD player is connected to a PAL TV.
- The default setting is NTSC.

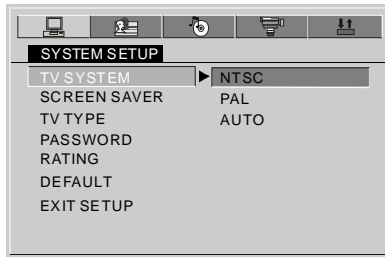

### NOTE:

Setting with incorrect TV system will result in black and white picture on your TV screen.

## SCREEN SAVER

If the screen saver is on, when your DVD player is at STOP or NO DISC status, or there is a frame frozen for a little long time, the screen saver will be displayed. This feature can protect the screen from damage.

- ON: Choose this setting to activate the screen saver.
- OFF: Choose this setting to cancel the screen saver.
- The default setting is ON.

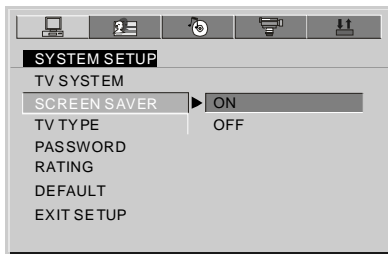

## TV TYPE

**16 : 9 (Wide Screen):** Choose this setting if your DVD player is connected to a wide screen TV. If you choose this setting and you don't have a wide screen TV, the images on the screen may appear distorted due to vertical compression.

**4 : 3 LB (Letter Box):** Choose this setting if your DVD player is connected to a normal ratio TV. You'll see the movie in their original aspect ratio (Height-to-width ratio). You'll see the entire frame of the movie. The movie might appear with black bars at the top and bottom of the screen.

**4 : 3 PS (Pan & Scan):** Choose this setting if your DVD player is connected to a normal ratio TV. You can fill the movie to the entire screen of your TV. This might mean that parts of the picture (The left and right edges) won't be seen.

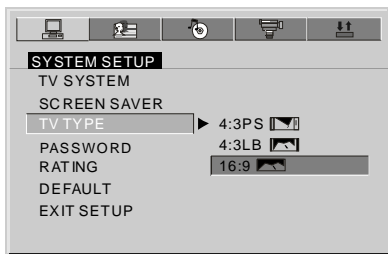

## NOTES:

- The image display ratio is related to the recorded disc format. Some discs can not be displayed in the aspect ratio chosen.
- If you play a disc recorded in 4:3 format on a wide screen TV, black bars will appear on the left and right side of the screen.
- You must adjust the screen setting depending on the type of the TV.

## PASSWORD

- 1 The player is locked with a default password 0000 and you can not change the rating. In order to change the rating, choose the password option and input the correct password to unlock the player.
- 2 After the player is unlocked, you can choose the rating option and change it, then you can choose password option and change it to a new password with 4-digit numbers and press ENTER button to lock it again.

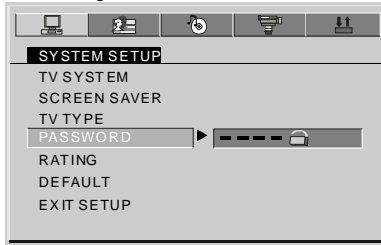

## RATING

The Rating feature works with DVD discs that have been assigned a rating. This helps you to control the types of DVDs that the player can be watched.

- There are eight limited rating options:  
KID SAFE, G, PG, PG 13, PG-R, R, NC-17, ADULT.
- The default setting is ADULT.

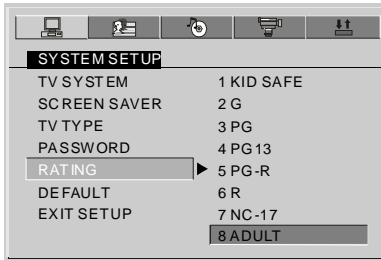

### NOTE:

If the password option is locked, you cannot change the rating.

## DEFAULT

Choose this option to resume factory settings.

The language setup options are illustrated below:

### OSD LANGUAGE

Highlight OSD LANGUAGE option, and press LEFT/RIGHT/UP/DOWN to choose the OSD language you prefer. Press ENTER to confirm, then the OSD will be displayed in that language. There are 5 optional OSD languages : English, German, Spanish, French and Italian.



### AUDIO LANGUAGE

Highlight the AUDIO LANG option, and press LEFT/RIGHT/UP/DOWN to choose the audio language you prefer. Press ENTER button to confirm. If the disc you are playing has that language available, it will output audio in that language. There are 8 optional audio languages: Chinese, English, Japanese, French, Spanish, Portuguese, Italian and German.

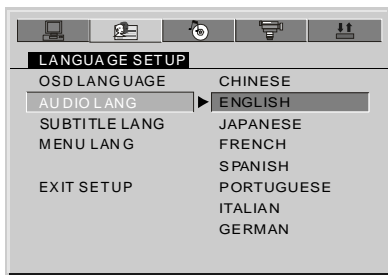

## SUBTITLE LANGUAGE

Highlight the SUBTITLE LANG option, and press LEFT/RIGHT/UP/DOWN to choose the subtitle language you prefer. Press ENTER to confirm. If the disc you are playing has that language available, it will displays subtitles in that language. There are 7 optional subtitle languages: Chinese, English, Japanese, French, Spanish, Italian and German.

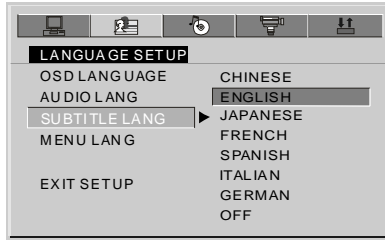

## MENU LANGUAGE

Highlight the MENU LANG option, and press LEFT/RIGHT/UP/DOWN to choose the menu language you prefer. Press ENTER to confirm. If the disc you are playing has that language available, it will displays menu in that language. There are 8 optional menu languages: Chinese, English, Japanese, French, Spanish, Portuguese, German and Italian.

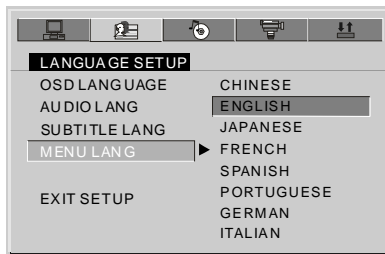

### NOTE:

If your preferred language isn't available, the disc's default language will be played. The default language of your DVD player is English.

**AUDIO OUT**

Highlight the AUDIO OUT option, and press LEFT/RIGHT/UP/DOWN to choose the audio output mode you prefer. Press ENTER to confirm:

There are 3 optional audio output modes: SPDIF/OFF, SPDIF / RAW and SPDIF/PCM.

- SPDIF/OFF: Choose this setting to output analog signal, and there will be no signal outputted from optical jack.
- SPDIF/ RAW: Choose this setting if your DVD player is connected to a power amplifier with an optical cable. When playing a disc recorded with Dolby Digital, DTS and MPEG audio formats, the corresponding digital signals will be outputted from the Optical Output jack.
- SPDIF / PCM: Choose this setting if your DVD player is connected to a 2-channel digital stereo amplifier. When playing a disc recorded with Dolby Digital and MPEG audio formats, audio signals will be modulated into a 2-channel PCM signal, and it will be outputted from the Optical Output jack .

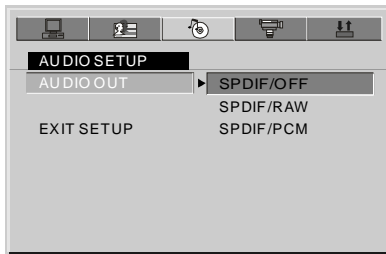

The video setup options are illustrated below:

## BRIGHTNESS

Use the UP and DOWN buttons to move the scroll and adjust the brightness.

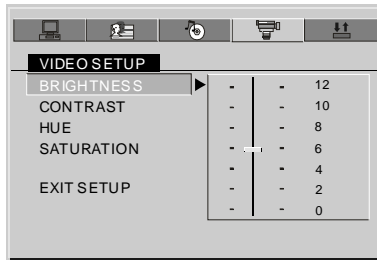

## CONTRAST

Use the UP and DOWN buttons to move the scroll and adjust the contrast.

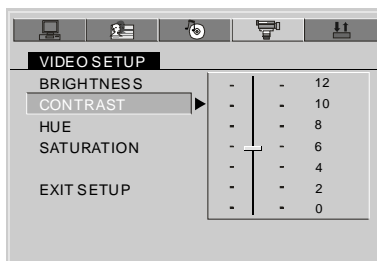



**HUE**

Use the UP and DOWN buttons to move the scroll and adjust the hue.

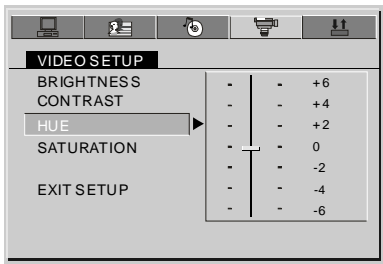

**SATURATION**

Use the UP and DOWN buttons to move the scroll and adjust the saturation.

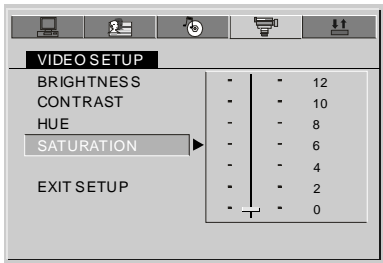

The digital setup options are illustrated below:

## DYNAMIC RANGE

Choose this setting to adjust the line out compressing ratio and get different effects. If adjusting to FULL, the audio signal peak value will be compressed to be minimum; while adjusting to OFF, to be maximum.

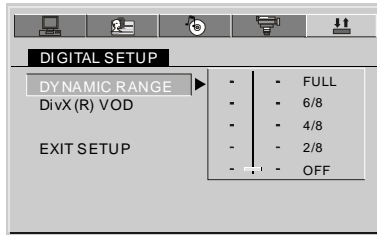

## DivX(R)VOD

DivX VOD files are downloaded after paying a rental from certain commercial websites. Prior to downloading a VOD you need to input the registration number of your DVD player on the purchase form on the site. Write down the VOD 8-character registration number so that you can fill in the form on the website you purchase your DivX VOD files from.

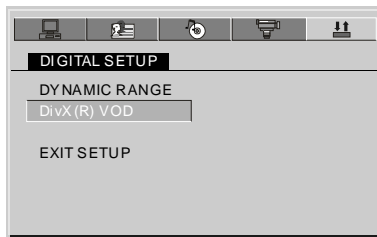

DIVX(R) VIDEO ON DEMAND  
YOUR REGISTRATION CODE IS:  
XXXXXXXXXX  
TO LEARN MORE VISIT [WWW.DIVX.COM/VOD](http://WWW.DIVX.COM/VOD)  
  
[DONE]

Note: If you cannot play a DivX VOD file recorded on a CD-R disc after downloading it, the rental period allocated during purchasing from the website may have expired. It is also possible that the recorded file is not compatible with your player because of different versions or incorrect download parameters. The parameters used when copying to CD-R may be another reason for this.

Since it is not possible here to supply all the information, parameters and advice relating to the use of DivX VOD files, we recommend that you visit specialist websites such as [www.divx.com/vod](http://www.divx.com/vod).

## Handling discs

### Handling

When holding  
with both hands



When holding  
with one hand



- Do not use damaged (Cracked or warped) discs.
- Do not scratch the signal surface or let it get dirty.
- Do not attach any paper or seals to discs.
- The player may be damaged if there is any exposed glue, etc., on discs. For rental discs in particular, extra labels are often attached to the discs. Check carefully for any exposed glue before using such discs.

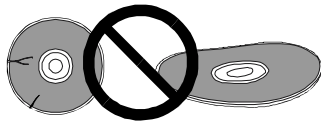
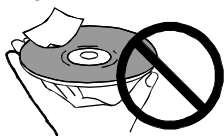

### Storing discs

- Always place discs in their case and store them vertically. Avoid storing discs in hot or humid places, places exposed to direct sunlight or places in which the temperature is extremely low.
- Read any cautions included with the disc carefully.

### Cleaning discs

- Fingerprints or dust on discs may reduce sound or picture quality. Remove them by gently wiping the disc from the center toward the edges using a soft cloth.

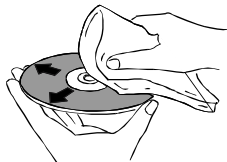

- Do not use benzene, thinner or other volatile chemicals. Do not use record spray or antistatic spray either.
- We recommend using the separately sold cleaning set to clean discs.
- For tough dirt, apply some water to a soft cloth, wring out thoroughly. Wipe off the dirt, then wipe the disc with a dry cloth.

### Irregular shaped discs

Irregular shaped discs (Heart-shaped discs, hexagonal discs, etc.) cannot be played on this player. Doing so could damage the player. Never use such discs.

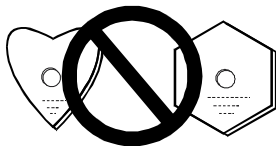

Picture is disturbed when playing a DVD recorded by a VCR.

- ➔ This player incorporates copyright protection technology. Some discs include signals protected against copied by a VCR. Such recorded discs can not be played properly.

Player cannot be operated with the remote control unit.

- ➔ Remote control unit is too far from the main unit or has too large angle with the remote sensor.
- ➔ The battery of the remote control is worn out.

TV or other device operates erroneously.

- ➔ The player's remote control unit may cause some TVs with wireless remote control to operate erroneously.

No sound is produced from speakers or sound is distorted.

- ➔ For some discs, 96 kHz digital output of linear PCM audio signals is prohibited.
- ➔ Disc is dirty.
- ➔ Pause or slow play mode is set.
- ➔ Main unit's volume is set to the minimum.
- ➔ Earphone is plugged in.

Volume is different for DVDs and CDs.

- ➔ This is due to the different recording methods.

The player crashes.

- ➔ Turn off power of the player and turn on again.
- ➔ Press OPEN button when "Loading..." appears on screen to pop out the disc.
- ➔ Ask qualified technician.

8cm disc can not be popped out.

- ➔ Slap on the player with disc window downward.
- ➔ Ask qualified technician.

No sound is produced or sound is distorted when connected to a TV, an amplifier, etc..

- ➔ Connection cables are not firmly plugged in or not contacted well.
- ➔ Connection plugs or jacks are dirty.
- ➔ Audio cables are not properly connected.
- ➔ Audio digital output is connected to a non-compatible AV amplifier, etc.
- ➔ Get wrong DTS setting.

Bad playback quality.

- ➔ The player is set to AV OUT but there are other AV signals inputted from AV jack.

Player gets hot.

- ➔ This is normal.

### Notes:

The player may stop operation properly due to static electricity or other external influences. In this case, usually solve the problem by unplugging the power cord and then plugging it in again. If you still can not solve it, consult with the nearest service center.

### Liquid crystal display

A few picture elements may be black or a particular color displayed on the LCD screen. This is normal.

