

Grizzly **Industrial, Inc.**®

MODEL G0742 **14" ABRASIVE CUT-OFF SAW** **OWNER'S MANUAL** *(For models manufactured since 10/12)*



COPYRIGHT © DECEMBER, 2012 BY GRIZZLY INDUSTRIAL, INC.
**WARNING: NO PORTION OF THIS MANUAL MAY BE REPRODUCED IN ANY SHAPE
OR FORM WITHOUT THE WRITTEN APPROVAL OF GRIZZLY INDUSTRIAL, INC.**
#TS15378 PRINTED IN CHINA



WARNING!

This manual provides critical safety instructions on the proper setup, operation, maintenance, and service of this machine/tool. Save this document, refer to it often, and use it to instruct other operators.

Failure to read, understand and follow the instructions in this manual may result in fire or serious personal injury—including amputation, electrocution, or death.

The owner of this machine/tool is solely responsible for its safe use. This responsibility includes but is not limited to proper installation in a safe environment, personnel training and usage authorization, proper inspection and maintenance, manual availability and comprehension, application of safety devices, cutting/sanding/grinding tool integrity, and the usage of personal protective equipment.

The manufacturer will not be held liable for injury or property damage from negligence, improper training, machine modifications or misuse.



WARNING!

Some dust created by power sanding, sawing, grinding, drilling, and other construction activities contains chemicals known to the State of California to cause cancer, birth defects or other reproductive harm. Some examples of these chemicals are:

- **Lead from lead-based paints.**
- **Crystalline silica from bricks, cement and other masonry products.**
- **Arsenic and chromium from chemically-treated lumber.**

Your risk from these exposures varies, depending on how often you do this type of work. To reduce your exposure to these chemicals: Work in a well ventilated area, and work with approved safety equipment, such as those dust masks that are specially designed to filter out microscopic particles.

Table of Contents

INTRODUCTION	2	SECTION 4: OPERATIONS	13
Machine Description	2	Operation Overview	13
Contact Info.....	2	Basic Controls.....	14
Manual Accuracy	2	Blade Feed Rate.....	15
Identification.....	3	Positioning Workpiece	16
Machine Data Sheet	4	Adjusting Inner Vise Jaw	16
SECTION 1: SAFETY	6	Adjusting Outer Vise Jaw.....	17
Safety Instructions for Machinery	6	Changing Blade	17
Additional Safety for Abrasive Cut-Off Saws	8	SECTION 5: ACCESSORIES	19
SECTION 2: POWER SUPPLY	9	SECTION 6: MAINTENANCE	21
Availability	9	Schedule	21
Full-Load Current Rating	9	Cleaning.....	21
120V Circuit Requirements.....	9	Lubrication	21
Grounding & Plug Requirements.....	10	SECTION 7: SERVICE	22
Extension Cords.....	10	Troubleshooting	22
SECTION 3: SETUP	11	Replacing Motor Brushes	23
Unpacking	11	SECTION 8: PARTS	24
Inventory	11	WARRANTY & RETURNS	29
Site Considerations.....	11		
Workbench Load.....	11		
Placement Location	11		
Test Run	12		

INTRODUCTION

Machine Description

The Model G0742 14" Abrasive Cut-Off Saw is used to cut thin-walled metal workpieces accurately, efficiently, and safely. The advantage of this saw over a typical metal-cutting bandsaw is that the cuts produced are cleaner, more accurate, and can be made much faster.

An adjustable vise holds the workpiece securely and ensures proper positioning of the workpiece relative to the blade.

The cutting angle is adjustable from 0° to 45° left or right and is measured by a scale located on the saw base.

Contact Info

We stand behind our machines. If you have any questions or need help, use the information below to contact us. Before contacting, please get the serial number and manufacture date of your machine. This will help us help you faster.

Grizzly Technical Support
1203 Lycoming Mall Circle
Muncy, PA 17756
Phone: (570) 546-9663
Email: techsupport@grizzly.com

We want your feedback on this manual. What did you like about it? Where could it be improved? Please take a few minutes to give us feedback.

Grizzly Documentation Manager
P.O. Box 2069
Bellingham, WA 98227-2069
Email: manuals@grizzly.com

Manual Accuracy

We are proud to provide a high-quality owner's manual with your new machine!

We made every effort to be exact with the instructions, specifications, drawings, and photographs contained inside. Sometimes we make mistakes, but our policy of continuous improvement also means that **sometimes the machine you receive will be slightly different than what is shown in the manual.**

If you find this to be the case, and the difference between the manual and machine leaves you confused about a procedure, check our website for an updated version. We post current manuals and manual updates for free on our website at www.grizzly.com.

Alternatively, you can call our Technical Support for help. Before calling, please write down the **Manufacture Date** and **Serial Number** stamped into the machine ID label (see below). This information helps us determine if updated documentation is available for your machine.

Grizzly Industrial		MODEL GXXXX MACHINE NAME
WARNING!		
To reduce risk of serious injury when using this machine:		
Motor:	manual before operation.	
Specification:	safety glasses and respirator.	
Specification:	rectly adjusted/setup and	
Specification:	power is connected to grounded circuit before starting.	
Weight:	4. Make sure the motor has stopped and disconnect power before adjustments, maintenance, or service.	
	5. DO NOT expose to rain or dampness.	
	6. DO NOT modify this machine in any way.	
	7.	
	8.	
	9. ended.	
	10. Maintain machine carefully to prevent accidents.	



Identification

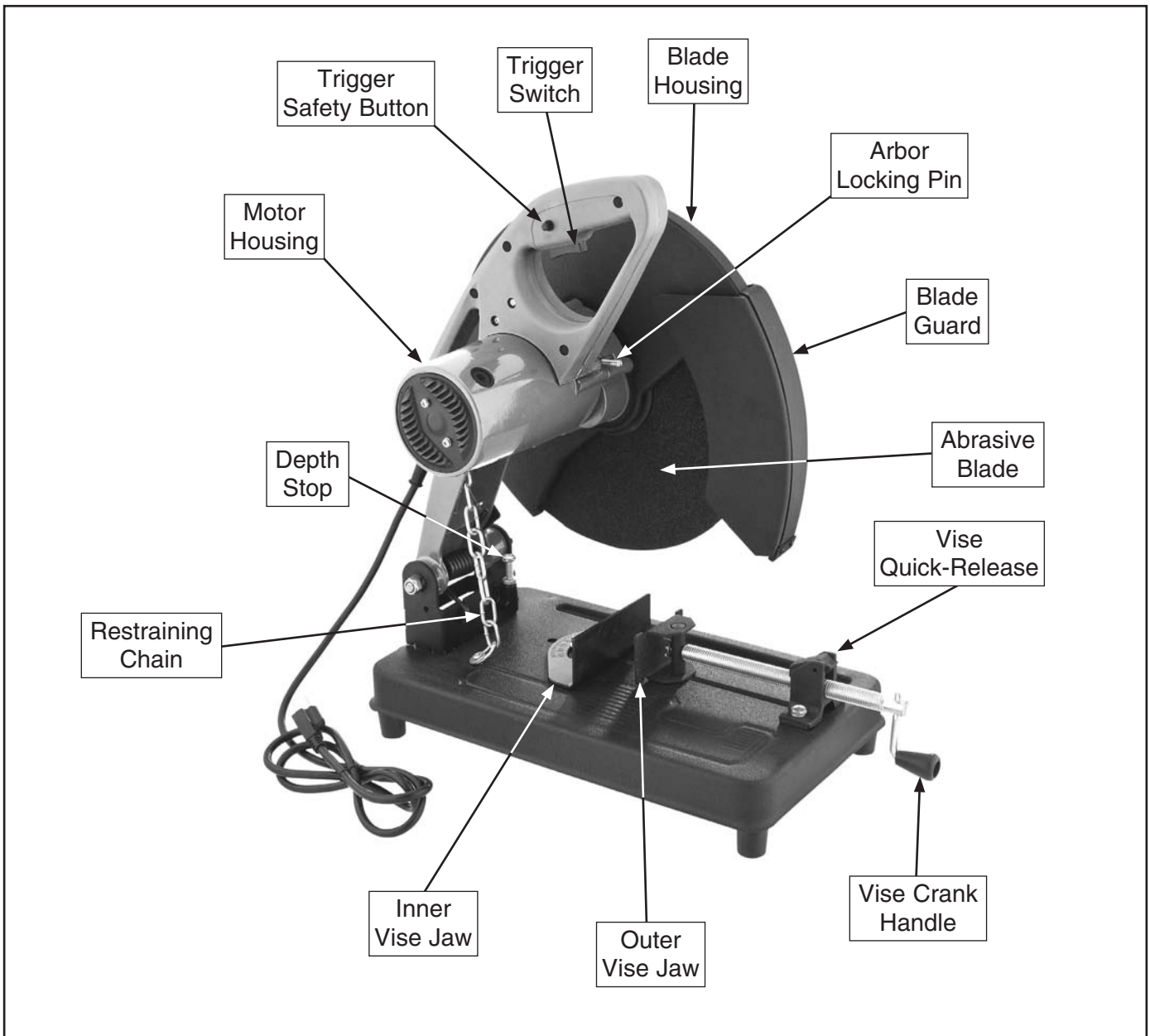

	<p>⚠ WARNING To reduce your risk of serious injury, read this entire manual BEFORE using machine.</p>
--	---





MACHINE DATA SHEET

© Grizzly Industrial, Inc. • Customer Service: (800) 523-4777 • Tech Support: (570) 546-9663

MODEL G0742 14" ABRASIVE CUT-OFF SAW

Product Dimensions:

Weight 33 lbs.
 Length/Width/Height 28½" x 10¾" x 23⅝"
 Foot Print (Length/Width) 19" x 10¾"

Shipping Dimensions:

Type Cardboard Box
 Weight 35 lbs.
 Length/Width/Height 21" x 12" x 17"

Electrical:

Switch Trigger Switch on Handle
 Switch Voltage 120V
 Cord Length 6 ft.
 Cord Gauge 14 AWG
 Minimum Circuit Size 20A
 Plug Type Included NEMA 5-15

Motor:

Type Universal
 Horsepower 2.4 HP (1800W)
 Voltage 120V
 Phase Single-Phase
 Amps 15A
 Speed 3800 RPM
 Cycle 60 Hz
 Power Transfer Direct Drive
 Bearings Shielded and Permanently Sealed



Main Specifications:

Operation Information

Blade Speed.....	3800 RPM
Blade Size.....	14"
Arbor Size.....	1"

Cutting Capacities

Angle Cuts.....	0°–45° L/R
Vise Jaw Depth.....	6¾"
Vise Jaw Height.....	2"
Maximum Capacity Square Tube @ 90°.....	4 ⁵ / ₁₆ " x 4 ⁵ / ₁₆ "
Maximum Capacity Channel Steel @ 90°.....	4 ¹¹ / ₁₆ " x 2 ¹ / ₈ "
Maximum Capacity Angle Iron @ 90°.....	3 ⁵ / ₁₆ " x ¾"
Maximum Capacity Round Tube @ 90°.....	4 ⁵ / ₁₆ "
Maximum Capacity Round Rod @ 90°.....	1 ¹⁵ / ₁₆ "

Construction

Table Construction.....	Sheet Metal
Saw Wheel Cover.....	Sheet Metal
Saw Wheel Guard.....	Sheet Metal
Handle.....	Plastic
Motor Housing.....	Cast Iron

Other Specifications:

Country of Origin.....	China
Sound Rating.....	97 dB
Warranty.....	1 Year
Serial Number Location.....	Machine ID Label on Motor Housing

Features:

- Spring-Assisted Return
- Adjustable Workpiece Angle from 0°–45° Left or Right
- Arbor/Angle Adjustment Tool Included
- Adjustable Spark Guard
- Quick-Adjust Catch on Vise
- Blade Included



SECTION 1: SAFETY

For Your Own Safety, Read Instruction Manual Before Operating This Machine

The purpose of safety symbols is to attract your attention to possible hazardous conditions. This manual uses a series of symbols and signal words intended to convey the level of importance of the safety messages. The progression of symbols is described below. Remember that safety messages by themselves do not eliminate danger and are not a substitute for proper accident prevention measures. Always use common sense and good judgment.

 **DANGER** Indicates an imminently hazardous situation which, if not avoided, WILL result in death or serious injury.

 **WARNING** Indicates a potentially hazardous situation which, if not avoided, COULD result in death or serious injury.

 **CAUTION** Indicates a potentially hazardous situation which, if not avoided, MAY result in minor or moderate injury. It may also be used to alert against unsafe practices.

NOTICE This symbol is used to alert the user to useful information about proper operation of the machine.

Safety Instructions for Machinery

WARNING

OWNER'S MANUAL. Read and understand this owner's manual BEFORE using machine.

TRAINED OPERATORS ONLY. Untrained operators have a higher risk of being hurt or killed. Only allow trained/supervised people to use this machine. When machine is not being used, disconnect power, remove switch keys, or lock-out machine to prevent unauthorized use—especially around children. Make workshop kid proof!

DANGEROUS ENVIRONMENTS. Do not use machinery in areas that are wet, cluttered, or have poor lighting. Operating machinery in these areas greatly increases the risk of accidents and injury.

MENTAL ALERTNESS REQUIRED. Full mental alertness is required for safe operation of machinery. Never operate under the influence of drugs or alcohol, when tired, or when distracted.

ELECTRICAL EQUIPMENT INJURY RISKS. You can be shocked, burned, or killed by touching live electrical components or improperly grounded machinery. To reduce this risk, only allow qualified service personnel to do electrical installation or repair work, and always disconnect power before accessing or exposing electrical equipment.

DISCONNECT POWER FIRST. Always disconnect machine from power supply BEFORE making adjustments, changing tooling, or servicing machine. This prevents an injury risk from unintended startup or contact with live electrical components.

EYE PROTECTION. Always wear ANSI-approved safety glasses or a face shield when operating or observing machinery to reduce the risk of eye injury or blindness from flying particles. Everyday eyeglasses are not approved safety glasses.



WARNING

WEARING PROPER APPAREL. Do not wear clothing, apparel or jewelry that can become entangled in moving parts. Always tie back or cover long hair. Wear non-slip footwear to avoid accidental slips, which could cause loss of workpiece control.

HAZARDOUS DUST. Dust created while using machinery may cause cancer, birth defects, or long-term respiratory damage. Be aware of dust hazards associated with each workpiece material, and always wear a NIOSH-approved respirator to reduce your risk.

HEARING PROTECTION. Always wear hearing protection when operating or observing loud machinery. Extended exposure to this noise without hearing protection can cause permanent hearing loss.

REMOVE ADJUSTING TOOLS. Tools left on machinery can become dangerous projectiles upon startup. Never leave chuck keys, wrenches, or any other tools on machine. Always verify removal before starting!

INTENDED USAGE. Only use machine for its intended purpose and never make modifications not approved by Grizzly. Modifying machine or using it differently than intended may result in malfunction or mechanical failure that can lead to serious personal injury or death!

AWKWARD POSITIONS. Keep proper footing and balance at all times when operating machine. Do not overreach! Avoid awkward hand positions that make workpiece control difficult or increase the risk of accidental injury.

CHILDREN & BYSTANDERS. Keep children and bystanders at a safe distance from the work area. Stop using machine if they become a distraction.

GUARDS & COVERS. Guards and covers reduce accidental contact with moving parts or flying debris. Make sure they are properly installed, undamaged, and working correctly.

FORCING MACHINERY. Do not force machine. It will do the job safer and better at the rate for which it was designed.

NEVER STAND ON MACHINE. Serious injury may occur if machine is tipped or if the cutting tool is unintentionally contacted.

STABLE MACHINE. Unexpected movement during operation greatly increases risk of injury or loss of control. Before starting, verify machine is stable and mobile base (if used) is locked.

USE RECOMMENDED ACCESSORIES. Consult this owner's manual or the manufacturer for recommended accessories. Using improper accessories will increase the risk of serious injury.

UNATTENDED OPERATION. To reduce the risk of accidental injury, turn machine **OFF** and ensure all moving parts completely stop before walking away. Never leave machine running while unattended.

MAINTAIN WITH CARE. Follow all maintenance instructions and lubrication schedules to keep machine in good working condition. A machine that is improperly maintained could malfunction, leading to serious personal injury or death.

CHECK DAMAGED PARTS. Regularly inspect machine for any condition that may affect safe operation. Immediately repair or replace damaged or mis-adjusted parts before operating machine.

MAINTAIN POWER CORDS. When disconnecting cord-connected machines from power, grab and pull the plug—NOT the cord. Pulling the cord may damage the wires inside. Do not handle cord/plug with wet hands. Avoid cord damage by keeping it away from heated surfaces, high traffic areas, harsh chemicals, and wet/damp locations.

EXPERIENCING DIFFICULTIES. If at any time you experience difficulties performing the intended operation, stop using the machine! Contact our Technical Support at (570) 546-9663.



WARNING

Additional Safety for Abrasive Cut-Off Saws

BLADE CONDITION. A cracked or damaged blade can fly apart during operation sending harmful debris at the operator. Do not operate with a dull, cracked, or badly worn blade. Inspect blade for cracks or damage before each use. Make sure blade is properly installed with included blade flanges and firmly secured.

BLADE SPEED. To reduce the risk of blade chipping or cracking, allow the blade to reach full speed before lowering it into workpiece.

BLADE SELECTION. Always use abrasive blades designed for this machine that are rated for the speed of the saw. Do not use toothed-typed or other types of blades.

BLADE TESTING. After installing a new blade, stand away from the cutting path and allow the blade to rotate at full speed for at least three minutes to reveal any flaws in the blade. In subsequent uses, perform this procedure for at least one minute before beginning a cutting operation.

BLADE USE. Do not allow the blade to twist or bend while cutting. Use only the cutting edge of the blade—not the sides of the blade—to perform the cut.

HAND PLACEMENT. The spinning blade can cause laceration or amputation injuries. Never place hands or fingers in the cutting path. Wait for the blade to come to a complete stop before removing workpiece.

PERSONAL PROTECTIVE EQUIPMENT. Sparks, abrasive dust, and flying debris are generated when using this saw. Wear approved safety glasses, face shield, and respirator. Wear non-flammable clothing to protect your skin. Wear steel-toed boots to protect your feet if the workpiece should fall.

FEED RATE. Jamming or banging the spinning blade into the workpiece could cause the blade to break apart and present impact injuries. Always use a slow and steady feed rate that is right for the operation.

MAGNESIUM. DO NOT attempt to cut magnesium with an abrasive saw. The chips produced by the blade could catch fire and burn at approximately 4000° F, resulting in serious personal injury and damage to the machine.

HOT SURFACES. Contact with hot surfaces from machine components, ejections of hot chips, and the workpiece itself can cause burns. Always allow the workpiece to cool before handling it.

HEARING PROTECTION. Noise generated by blade and workpiece vibration, material handling, and power transmission can cause permanent hearing loss over time and interfere with communication and audible signals. Always wear hearing protection when using this saw.

WORKPIECE HANDLING. Always support the workpiece with table, vise, or some type of support fixture. Flag long pieces to avoid a tripping hazard. Never hold the workpiece with your hands during a cut. Use jigs or fixtures with small workpieces that can be secured in the vise.

FIRE HAZARD. This saw creates a stream of sparks during operation. To reduce fire hazards do not operate near flammable material, liquid, or gas.

WORKPIECE MATERIAL. This saw is designed to cut only steel. Do not attempt to cut masonry, ceramic, plastic, or wood. Do not exceed cutting capacities listed in the machine data sheet that is included in this manual.

LOSS OF STABILITY. If the saw or workpiece unexpectedly moves, the operator's hands can be drawn into the spinning blade. Make sure the saw is stable on a non-slip surface that can properly support the saw and workpiece. Keep your body and hands in a stable position out of the cutting path. Do not over-reach.

BLADE GUARDS. The blade housing and guard are designed to protect you from the rotating blade. Always keep the housing and guard in good condition and in place while cutting.



SECTION 2: POWER SUPPLY

Availability

Before installing the machine, consider the availability and proximity of the required power supply circuit. If an existing circuit does not meet the requirements for this machine, a new circuit must be installed. To minimize the risk of electrocution, fire, or equipment damage, installation work and electrical wiring must be done by an electrician or qualified service personnel in accordance with all applicable codes and standards.

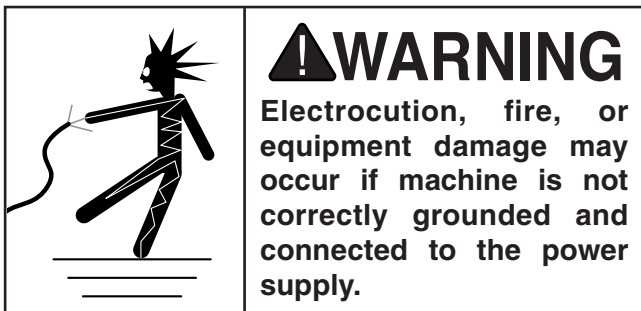

Full-Load Current Rating

The full-load current rating is the amperage a machine draws at 100% of the rated output power. On machines with multiple motors, this is the amperage drawn by the largest motor or sum of all motors and electrical devices that might operate at one time during normal operations.

Full-Load Current Rating at 120V 15 Amps

The full-load current is not the maximum amount of amps that the machine will draw. If the machine is overloaded, it will draw additional amps beyond the full-load rating.

If the machine is overloaded for a sufficient length of time, damage, overheating, or fire may result—especially if connected to an undersized circuit. To reduce the risk of these hazards, avoid overloading the machine during operation and make sure it is connected to a power supply circuit that meets the requirements in the following section.

! WARNING

Serious injury could occur if you connect the machine to power before completing the setup process. DO NOT connect to power until instructed later in this manual.

120V Circuit Requirements

This machine is prewired to operate on a power supply circuit that has a verified ground and meets the following requirements:

Nominal Voltage 120V
Cycle 60 Hz
Phase Single-Phase
Power Supply Circuit 20 Amps

A power supply circuit includes all electrical equipment between the breaker box or fuse panel in the building and the machine. The power supply circuit used for this machine must be sized to safely handle the full-load current drawn from the machine for an extended period of time. (If this machine is connected to a circuit protected by fuses, use a time delay fuse marked D.)

! CAUTION

For your own safety and protection of property, consult an electrician if you are unsure about wiring practices or electrical codes in your area.

Note: *The circuit requirements listed in this manual apply to a dedicated circuit—where only one machine will be running at a time. If this machine will be connected to a shared circuit where multiple machines will be running at the same time, consult a qualified electrician to ensure that the circuit is properly sized for safe operation.*



Grounding & Plug Requirements

This machine **MUST** be grounded. In the event of certain malfunctions or breakdowns, grounding reduces the risk of electric shock by providing a path of least resistance for electric current.

This machine is equipped with a power cord that has an equipment-grounding wire and a grounding plug (similar to the figure below). The plug must only be inserted into a matching receptacle (outlet) that is properly installed and grounded in accordance with all local codes and ordinances.

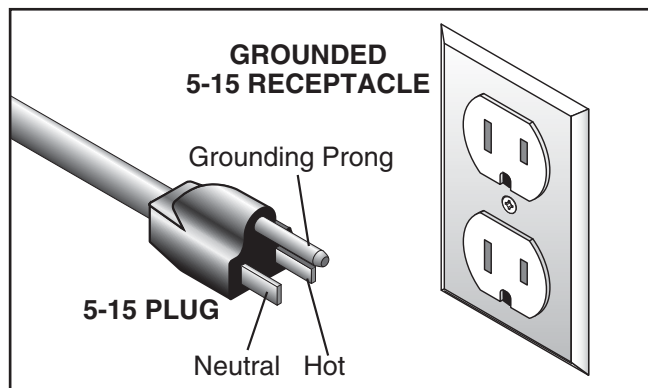
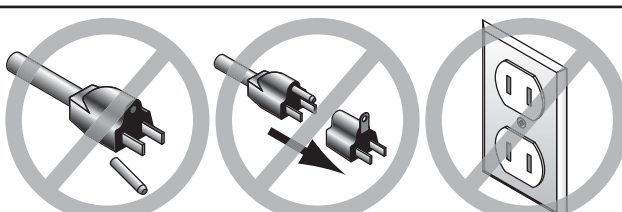

Figure 1. Typical 5-15 plug and receptacle.

⚠ CAUTION



SHOCK HAZARD!

Two-prong outlets do not meet the grounding requirements for this machine. Do not modify or use an adapter on the plug provided—if it will not fit the outlet, have a qualified electrician install the proper outlet with a verified ground.

Improper connection of the equipment-grounding wire can result in a risk of electric shock. The wire with green insulation (with or without yellow stripes) is the equipment-grounding wire. If repair or replacement of the power cord or plug is necessary, do not connect the equipment-grounding wire to a live (current carrying) terminal.

Check with a qualified electrician or service personnel if you do not understand these grounding requirements, or if you are in doubt about whether the tool is properly grounded. If you ever notice that a cord or plug is damaged or worn, disconnect it from power, and immediately replace it with a new one.

Extension Cords

We do not recommend using an extension cord with this machine. If you must use an extension cord, only use it if absolutely necessary and only on a temporary basis.

Extension cords cause voltage drop, which may damage electrical components and shorten motor life. Voltage drop increases as the extension cord size gets longer and the gauge size gets smaller (higher gauge numbers indicate smaller sizes).

Any extension cord used with this machine must contain a ground wire, match the required plug and receptacle, and meet the following requirements:

- Minimum Gauge Size14 AWG**
- Maximum Length (Shorter is Better).....50 ft.**



SECTION 3: SETUP

Unpacking

Your machine was carefully packaged for safe transportation. Remove the packaging materials from around your machine and inspect it. If you discover any damage, *please call us immediately at (570) 546-9663 for advice.*

Save the containers and all packing materials for possible inspection by the carrier or its agent. *Otherwise, filing a freight claim can be difficult.*

When you are completely satisfied with the condition of your shipment, inventory the contents.



Inventory

Besides the arbor wrench and a set of spare motor brushes, the Model G0742 is packaged as a single unit, fully assembled, and ready for use.



Figure 2. Model G0742 Abrasive Cut-Off Saw.

Site Considerations

Workbench Load

Refer to the **Machine Data Sheet** for the weight and footprint specifications of your machine. Some workbenches may require additional reinforcement to support both the machine and materials.

Placement Location

Consider existing and anticipated needs, size of material to be processed through each machine, and space for auxiliary stands, work tables or other machinery when establishing a location for your new machine. See **Figure 3** for the minimum working clearances.

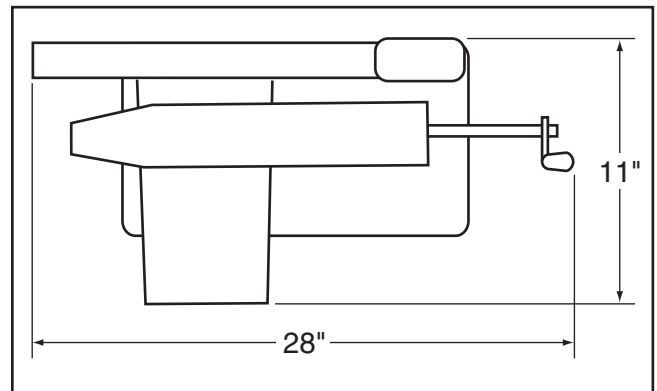
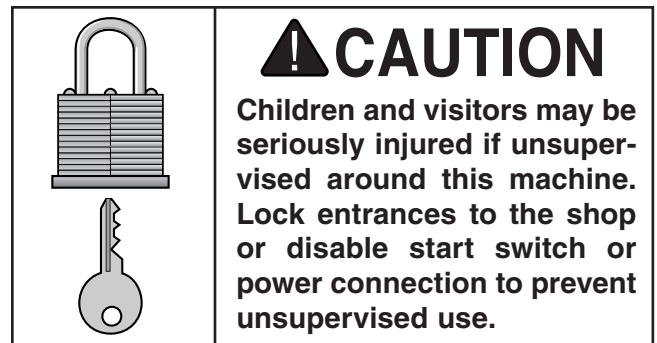

Figure 3. Minimum working clearances.



Test Run

Once the assembly is complete, test run your machine to make sure it runs properly.

If, during the test run, you cannot easily locate the source of an unusual noise or vibration, stop using the machine immediately, then review the **Troubleshooting** on **Page 22**.

If you still cannot remedy a problem, contact our Tech Support at (570) 546-9663 for assistance.

To test run the machine:

1. Make sure you have read the safety instructions at the beginning of the manual and that the machine is set up properly.
2. Make sure all tools and objects used during setup are cleared away from the machine.
3. Inspect the condition of the blade.

—If there is evidence of chipping, cracking, or any other damage, do not use the blade.

4. Make sure the blade assembly is unchained and all the way up, then lower the blade guard all the way down.
5. Put on safety glasses and hearing protection.
6. Connect the machine to the power source.
7. Stand away from the cutting path, push the trigger safety button in, then pull the trigger switch to turn the saw **ON**.
8. Run the saw for at least three minutes to verify the operational condition of the blade.
9. Listen and watch for abnormal noises or actions. The machine should run smoothly with little or no vibration or rubbing noises.

—Strange or unusual noises must be investigated and corrected before operating the machine further. Always disconnect the machine from power when investigating or correcting problems.
10. Release the trigger switch to turn the machine **OFF**.



SECTION 4: OPERATIONS

Operation Overview

The purpose of this overview is to provide the novice machine operator with a basic understanding of how the machine is used during operation, so the machine controls/components discussed later in this manual are easier to understand.

Due to the generic nature of this overview, it is **not** intended to be an instructional guide. To learn more about specific operations, read this entire manual and seek additional training from experienced machine operators, and do additional research outside of this manual by reading "how-to" books, trade magazines, or websites.

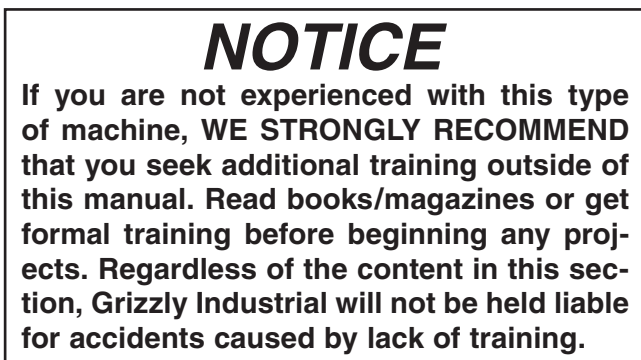
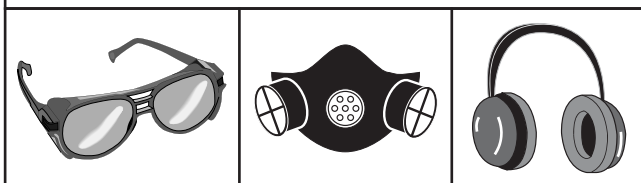
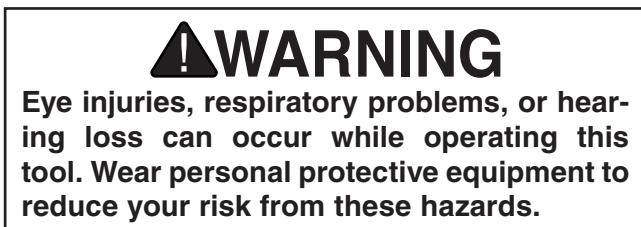

To complete a typical operation, the operator does the following:

1. Examines the workpiece to make sure it is suitable for cutting.
2. Attaches the inner vise jaw in either the forward or rear position, adjusts the angle, then secures the vise jaw.
3. Places the workpiece against the inner vise jaw in a stable position with the thinnest section of the workpiece facing up.
4. Adjusts the outer vise jaw so that the workpiece is held firmly in place between the jaws.
5. Adjusts the depth stop bolt for the operation.
6. Puts on personal protective equipment (approved safety glasses, face shield, respirator, hearing protection, and non-flammable clothes).
7. Stands to the side of the cutting path, pushes the trigger safety button in, then presses the trigger switch, and allows the blade to reach full speed.
8. Lowers the blade into the workpiece with a slow and steady feed rate that is correct for the operation.
9. When the cut is complete, raises the blade up and away from the workpiece, then releases the trigger to turn the saw **OFF**.
10. Allows the workpiece to cool before removing it from the machine.



Basic Controls

Use the descriptions and figures below to gain a better understanding of the basic controls of the saw.

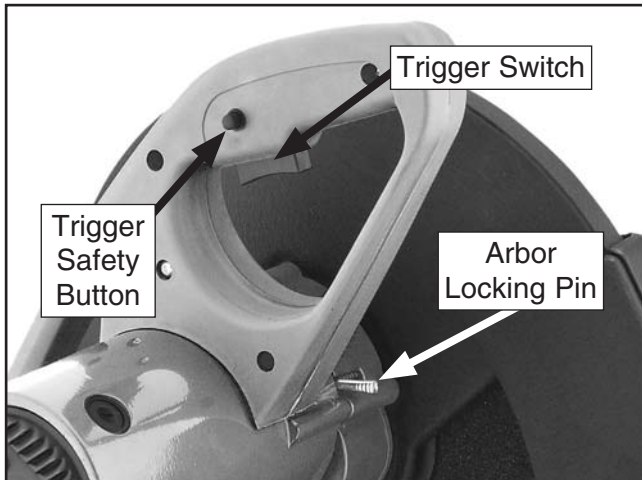

Figure 4. Upper controls.

Trigger Safety Button. Allows the trigger switch to turn the saw **ON**. This button must be pushed in before using the trigger switch.

Trigger Switch. Turns the saw **ON** when pressed. Release the trigger to turn the saw **OFF**.

Arbor Locking Pin. Keeps the blade from turning when loosening or tightening the arbor bolt during blade replacement.

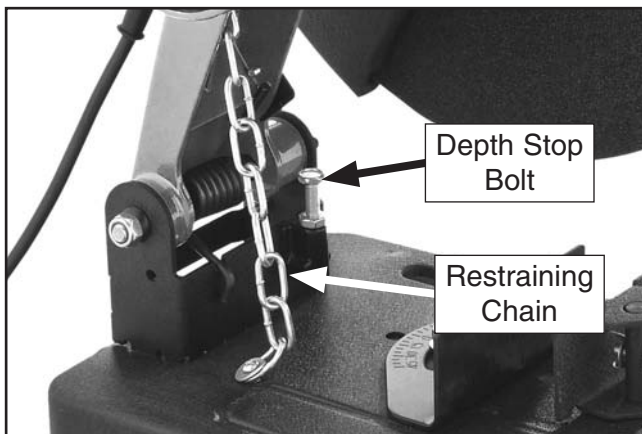

Figure 5. Pivot controls.

Depth Stop Bolt. Limits the downward movement of the saw.

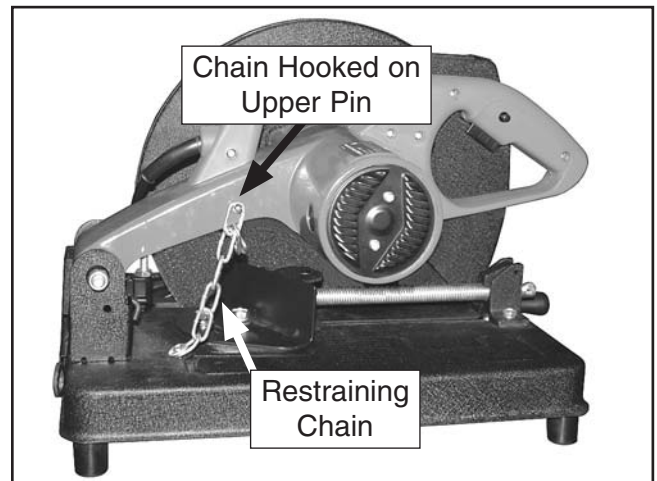

Figure 6. Saw locked in storage or transport position.

Restraining Chain. Limits the upward movement of the saw. Hook the chain on the upper pin to lock the saw into a down position for storage or transport (see **Figure 6**).

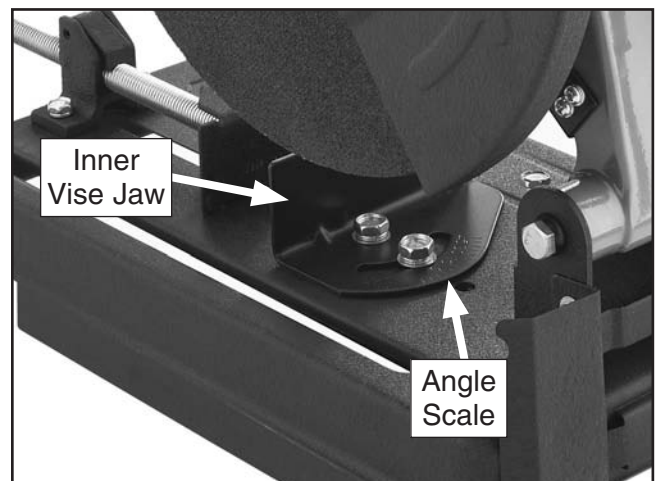

Figure 7. Inner vise jaw controls.

Inner Vise Jaw. Controls the angle of the cut. Loosen the bolt over the scale to adjust the jaw position.

Angle Scale. Displays the angle of the cut 45° left or right.



Outer Vise Jaw. Holds the workpiece against the inner vise jaw. This jaw automatically pivots to match the angle of the workpiece.

Vise Quick-Release. When the rear lip is pressed, disengages the leadscrew threads and allows the outer vise jaw to rapidly move in or out. Re-engage the quick-release with the leadscrew threads to use the vise crank handle.

Vise Crank Handle. Fine tunes the pressure exerted on the workpiece by the outer vise jaw.

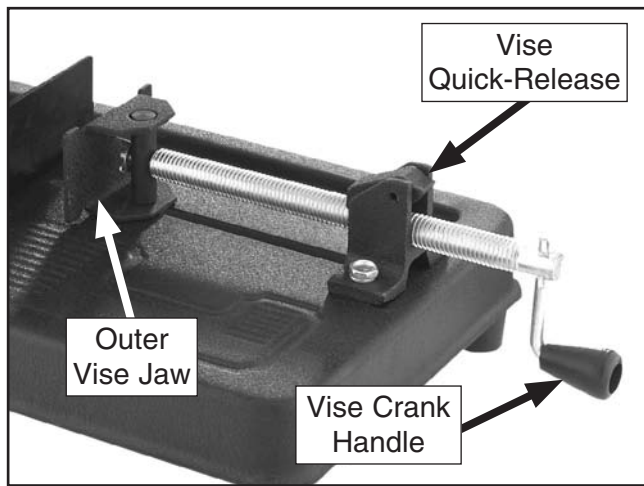

Figure 8. Outer vise jaw controls.

Blade Feed Rate

Blade feed rate refers to the speed that the blade cuts through a workpiece. On the Model G0742, feed rate is controlled by the amount of pressure exerted on the handle by the user.

Cutting with a feed rate that is too slow can result in lengthy, inefficient cuts, and workpiece overheating.

Cutting with a feed rate that is too fast may cause excessive blade wear and generate excess heat. When cutting small or thin-walled workpieces, the edges of the cut may become rough or torn.

Use scrap workpiece material to practice and gain experience regarding blade feed rates.

!WARNING

Jamming or bumping the blade into the workpiece could cause the blade to break apart and send harmful debris into the operator. ALWAYS allow the blade to reach full speed and lower it into the workpiece with a slow and steady feed rate.



Positioning Workpiece

The optimal workpiece position is with the blade centerline (when in the down position) over the centerline of the workpiece (see **Figure 9** for examples).

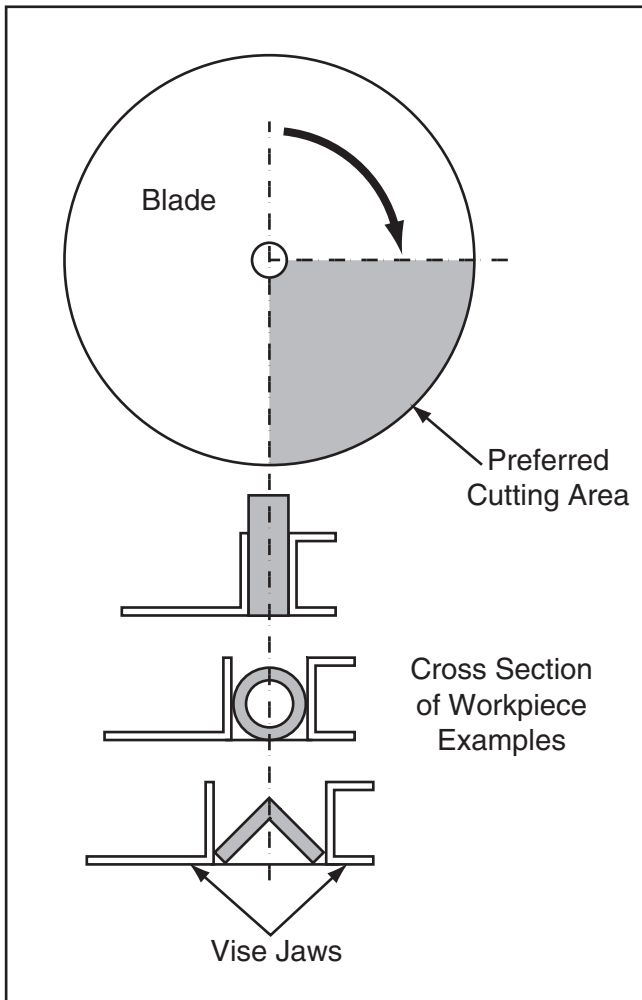

Figure 9. Examples of blade and workpiece centerline alignment.

The position of the vise jaws determines the position of the workpiece relative to the blade. Perform the instructions in the next subsections to properly position and secure the workpiece.

⚠WARNING

If the workpiece should unexpectedly move during operation, the blade could bind and break apart, sending flying debris at the operator. Always make sure the workpiece is held firmly in the vise and properly supported.

Adjusting Inner Vise Jaw

1. DISCONNECT SAW FROM POWER!
2. Use the two hex bolts to attach the inner jaw to the base in either the forward or rear position (see **Figure 10**). Use this feature to align the blade and workpiece centerlines.

Note: Leave the hex bolts finger-tight for now. They will be fully tightened in the next step.

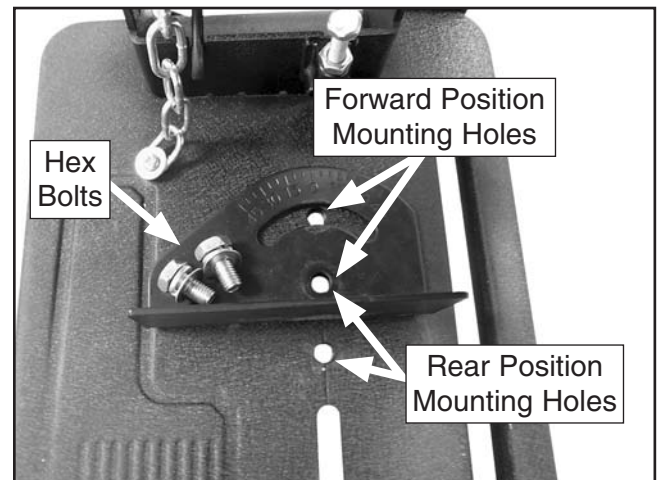

Figure 10. Inner vise jaw mounting positions.

3. Use the embossed scale on the vise jaw or a protractor to adjust the angle of the cut, then fully tighten both hex bolts.



Adjusting Outer Vise Jaw

1. DISCONNECT SAW FROM POWER!
2. Position the workpiece against the inner vise jaw in a stable position with the thinnest section facing up.
3. Press down on the rear lip of the vise quick-release (see **Figure 11**) to disengage the leadscrew threads.

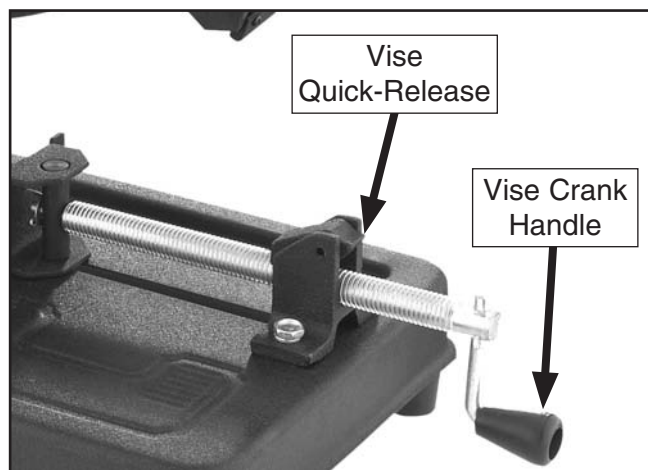
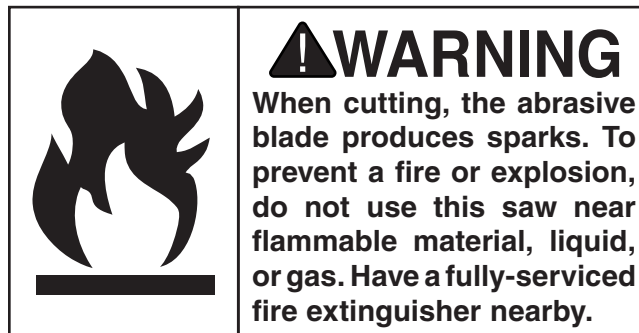

Figure 11. Vise quick-release.

4. Move the leadscrew forward so the outer vise jaw is against the workpiece, then re-engage the quick-release with the leadscrew threads.
5. Use the vise crank handle to apply additional vise pressure on the workpiece until it is firmly held between the jaws (see **Figure 12** for an example).

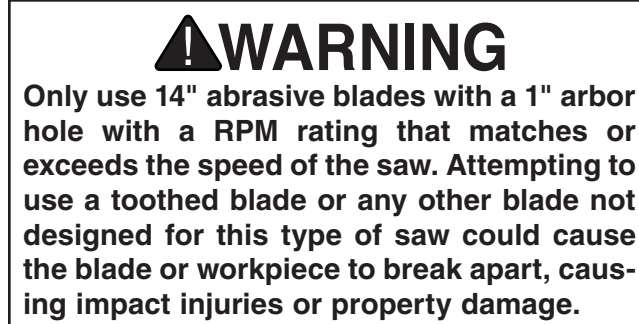

Figure 12. Example photo of workpiece held firmly between the vise jaws.



WARNING
When cutting, the abrasive blade produces sparks. To prevent a fire or explosion, do not use this saw near flammable material, liquid, or gas. Have a fully-serviced fire extinguisher nearby.

Changing Blade



WARNING

Only use 14" abrasive blades with a 1" arbor hole with a RPM rating that matches or exceeds the speed of the saw. Attempting to use a toothed blade or any other blade not designed for this type of saw could cause the blade or workpiece to break apart, causing impact injuries or property damage.

To change the blade:

1. DISCONNECT SAW FROM POWER!
2. Raise the blade guard all the way to expose the arbor bolt (see **Figure 13**).

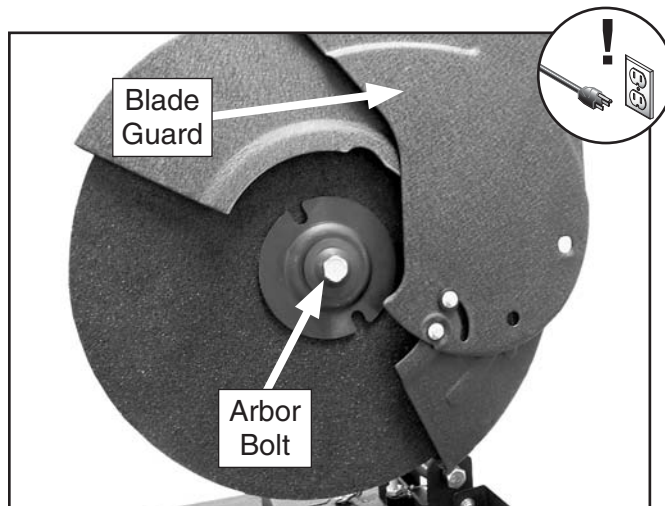

Figure 13. Blade guard in the up position.



3. Press the arbor locking pin towards the blade guard (see **Figure 14**), and rotate the blade until the pin moves inward and locks the arbor in place. While holding the pin in, loosen the arbor bolt.

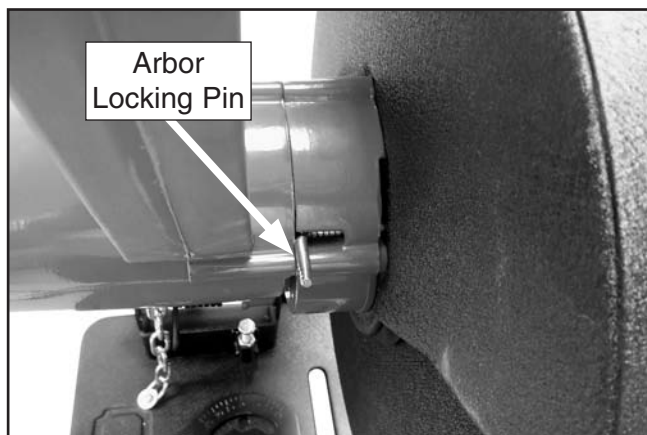

Figure 14. Arbor locking pin.

4. Remove the arbor bolt, the arbor washer, the outer arbor flange, and the blade (see **Figure 15**).

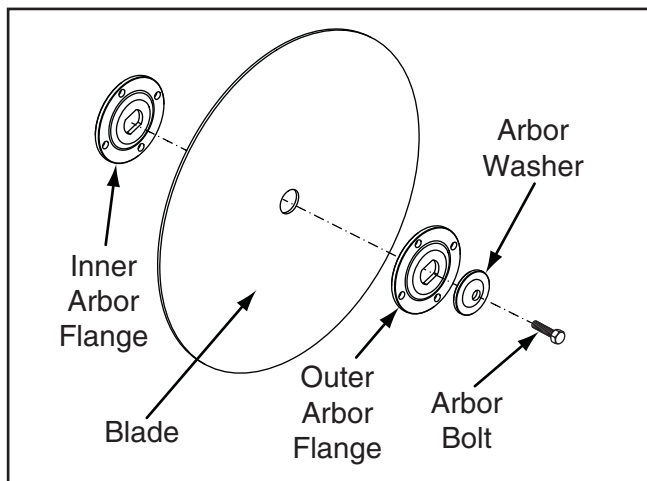

Figure 15. Blade installation order.

5. Visually inspect the blade for warp, cracks, chips, or any other damage. If there is evidence of blade damage, discard the blade and install a new one.

6. Install the new blade and re-install the parts removed in **Step 4**.

Note: *The metal rim of the blade arbor hole can face in or out.*

Additionally, make sure the non-cylindrical holes of the arbor flanges are properly aligned and seated on the arbor.

7. Firmly tighten the arbor bolt, but do not attempt to over-tighten—this could cause the blade to crack.

Note: *If blade does crack during installation, DO NOT use it. Discard the cracked blade and install a new one.*

8. Connect the saw to power, stand away from the cutting path, then run the saw for at least three minutes to verify the operational condition of the blade.

9. Turn the saw **OFF**.

⚠ CAUTION

Before EACH use, repeat Step 8 for one minute. If the blade shows any evidence of damage, DO NOT use! Discard it and install a new blade.



SECTION 5: ACCESSORIES

!WARNING

Installing unapproved accessories may cause machine to malfunction, resulting in serious personal injury or machine damage. To reduce this risk, only install accessories recommended for this machine by Grizzly.

NOTICE

Refer to our website or latest catalog for additional recommended accessories.

Basic Eye Protection

T20501—Face Shield Crown Protector 4"

T20502—Face Shield Crown Protector 7"

T20503—Face Shield Window

T20452—"Kirova" Anti-Reflective S. Glasses

T20451—"Kirova" Clear Safety Glasses

H0736—Shop Fox® Safety Glasses

H7194—Bifocal Safety Glasses 1.5

H7195—Bifocal Safety Glasses 2.0

H7196—Bifocal Safety Glasses 2.5



Figure 16. Assortment of basic eye protection.

Replacement Abrasive Cut-Off Blades

G7429—14" X 1/8" X 1", Type 1, 24-Grit

G7403—14" X 7/16" X 1", Type 1, 36-Grit

H7078—14" X 3/32" X 1", Type 1, 36-Grit, 5-Pack



Figure 17. Replacement 14" Abrasive Wheels.

G8983—Tilting Roller Stand

Adjusts from 26" to 44", 0°-45°. 150 lb. capacity.

G8984—Single Roller Stand

Adjusts from 26 5/8" to 45". 250 lb. capacity.

G8985—5 Roller Stand

Adjusts from 26" to 44 5/8". 250 lb. capacity.

These super heavy-duty roller stands feature convenient hand knobs for fast height adjustment.



Figure 18. SHOP FOX® Roller Stands.

order online at www.grizzly.com or call 1-800-523-4777



- H2499—Small Half-Mask Respirator**
- H3631—Medium Half-Mask Respirator**
- H3632—Large Half-Mask Respirator**
- H3635—Cartridge Filter Pair P100**

Wood dust has been linked to nasal cancer and severe respiratory illnesses. If you work around dust everyday, a half-mask respirator can be a lifesaver. Also compatible with safety glasses!



Figure 19. Half-mask respirator with disposable cartridge filters.

- H4978—Deluxe Earmuffs - 27dB**
 - H4979—Twin Cup Hearing Protector - 29dB**
 - T20446—Ear Plugs 200 Pair - 31dB**
- Protect your hearing before its too late. Especially important if you or employees operate for hours at a time.



Figure 20. Hearing protection assortment.

- G5618—Deburring Tool w/2 Blades**
- G5619—Extra Aluminum Blades**
- G5620—Extra Brass and Cast Iron Blade**

The quickest tool for smoothing freshly machined metal edges. Comes with two blades, one for steel and aluminum and one for brass and cast iron.



Figure 21. G5618 Deburring tool.

- G7313—700 lb Capacity SHOP FOX® Stand**
- A perfect stand for mounting your smaller machines on. Sturdy and rugged for everyday shop use.

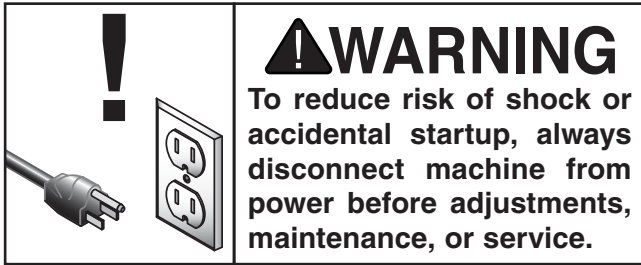

Figure 22. G7313 SHOP FOX® Stand.

order online at www.grizzly.com or call 1-800-523-4777



SECTION 6: MAINTENANCE



Schedule

For optimum performance from your machine, follow this maintenance schedule and refer to any specific instructions given in this section.

Daily Check:

- Loose mounting bolts.
- Damaged saw blade.
- Worn or damaged wires.
- Any other unsafe condition.

Daily Maintenance:

- Inspect/replace damaged blade.
- Clean the machine thoroughly.

Weekly Maintenance:

- Lubricate the vise leadscrew.

Cleaning

Cleaning the Model G0742 is relatively easy. Vacuum excess metal chips and wipe off the remaining debris and residue with a dry cloth.

Lubrication

The motor bearings are permanently lubricated at the factory and do not require any further lubrication. Simply leave them alone unless they require replacement.

Clean the metal chips from the vise leadscrew threads with a stiff brush, then apply a dry lubricant (see **Model G4682** below) to the entire length.

G4682—Dry Coating Lube

Spray on saw blades, router bits, shaper cutters, leadscrews, and even table tops to form a low-friction coating that works great, even under high temperature and pressure. Contains no silicone or oil, so it will not stain or gum up.



Figure 23. Model G4682 Dry Coating Lube.



SECTION 7: SERVICE

Review the troubleshooting and procedures in this section if a problem develops with your machine. If you need replacement parts or additional help with a procedure, call our Technical Support at (570) 546-9663.

Note: Please gather the serial number and manufacture date of your machine before calling.

Troubleshooting

Symptom	Possible Cause	Corrective Action
Machine does not start or a breaker trips.	<ol style="list-style-type: none"> 1. Power supply at fault. 2. Wall fuse/circuit breaker is blown/tripped. 3. Wiring is open/has high resistance. 4. Trigger switch at fault. 5. Motor brushes at fault. 6. Plug/receptacle at fault or wired incorrectly. 7. Motor at fault. 	<ol style="list-style-type: none"> 1. Ensure power supply is switched ON. 2. Reset or replace fuse or breaker; repair short if present. 3. Check for broken wires or disconnected/corroded connections, and repair/replace as necessary. 4. Replace faulty trigger switch. 5. Replace motor brushes as a set. 6. Test for good contacts; correct the wiring. 7. Test/repair/replace.
Machine stalls or is overloaded.	<ol style="list-style-type: none"> 1. Feed rate too fast (too much pressure). 2. Motor brushes at fault. 3. Motor is at fault. 	<ol style="list-style-type: none"> 1. Decrease feed rate. 2. Replace motor brush set. 3. Test/repair/replace.
Machine has vibration or noisy operation.	<ol style="list-style-type: none"> 1. Motor or component is loose. 2. Motor mount loose/broken. 3. Machine sits unevenly. 4. Motor bearings are at fault. 	<ol style="list-style-type: none"> 1. Inspect/replace stripped or damaged bolts/nuts, and re-tighten with thread locking fluid. 2. Tighten/replace. 3. Relocate/shim machine. 4. Test by rotating shaft; rotational grinding/loose shaft requires bearing replacement.
Premature blade wear.	<ol style="list-style-type: none"> 1. Feed rate too fast (too much pressure). 2. Incorrect blade/machine for material type. 	<ol style="list-style-type: none"> 1. Decrease feed rate. 2. Choose the correct blade/machine for the material type.
Vibration when cutting.	<ol style="list-style-type: none"> 1. Blade is damaged. 2. Workpiece is not secured in vise. 3. Cross section of workpiece is too large. 	<ol style="list-style-type: none"> 1. Inspect/replace blade. 2. Secure workpiece. 3. Adhere to maximum cutting capacities for this machine.
Blade sticks in cut.	<ol style="list-style-type: none"> 1. Feed rate too fast (too much pressure). 2. Waste material buildup on blade. 	<ol style="list-style-type: none"> 1. Decrease feed rate. 2. Clean blade.
Blade is chipped or is out of round.	<ol style="list-style-type: none"> 1. Feed rate too fast (too much pressure). 2. Blade was in contact with the workpiece when machine was turned ON. 3. Blade allowed to hop during cut. 4. Workpiece shifted in vise. 	<ol style="list-style-type: none"> 1. Decrease feed rate. 2. Never start the blade in contact with the workpiece. 3. Allow blade to enter workpiece in a slow and controlled manner, follow through with a smooth and even pressure. 4. Be sure workpiece is properly clamped before starting cut.



Replacing Motor Brushes

The carbon motor brushes (see **Figure 24**) will wear with time and need to be replaced.

Typically, a sluggish response from the motor is good indication of worn motor brushes. However, if you continue to operate the saw after this point, it will eventually stop working.

Contact Grizzly to order two of Part Number P0742025.

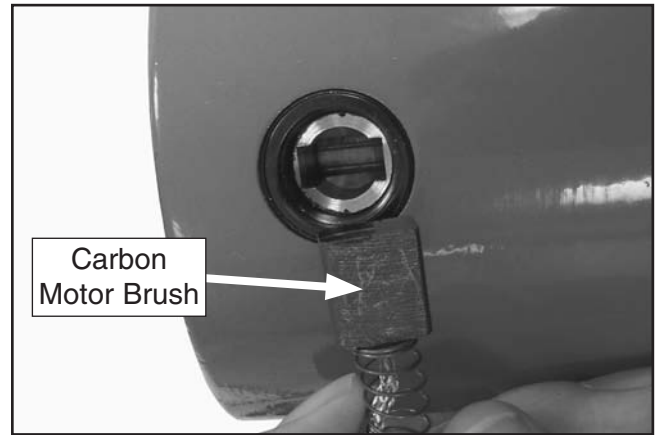
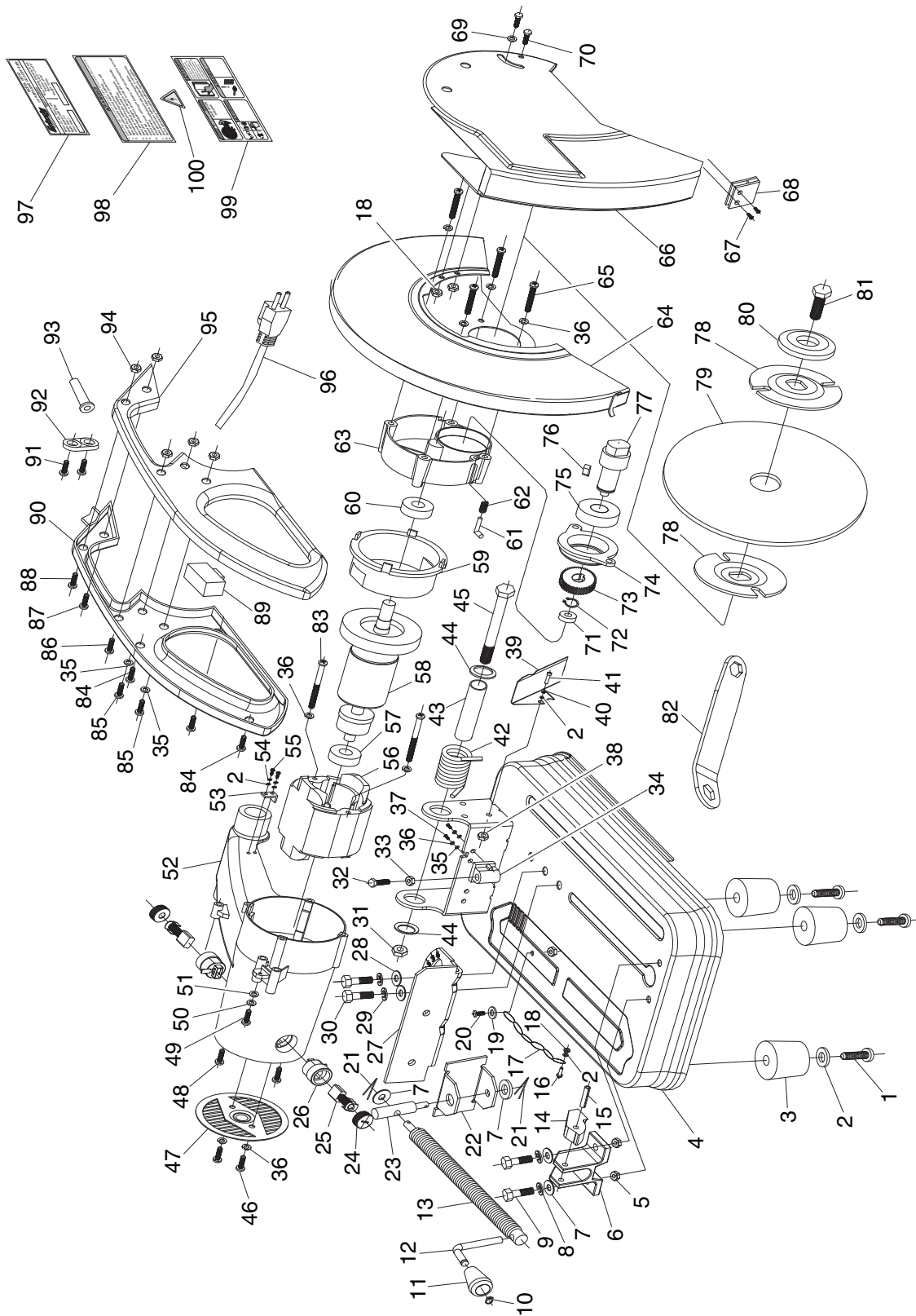

Figure 24. Motor brush removed from motor.

To replace the motor brushes, unthread the plastic caps that secure them (one on each side of the motor housing) with a flat-tipped screwdriver, then remove the brushes. If either carbon brush is less than $\frac{3}{8}$ " in length, replace both brushes as a set.



SECTION 8: PARTS



Please Note: We do our best to stock replacement parts whenever possible, but we cannot guarantee that all parts shown here are available for purchase. Call (800) 523-4777 or visit our online parts store at www.grizzly.com to check for availability.



Parts List

REF	PART #	DESCRIPTION
1	PS81M	PHLP HD SCR M6-1 X 40
2	PW03M	FLAT WASHER 6MM
3	P0742003	RUBBER FOOT
4	P0742004	BASE
5	PN03M	HEX NUT M8-1.25
6	P0742006	JAW BRACKET
7	PW01M	FLAT WASHER 8MM
8	PLW04M	LOCK WASHER 8MM
9	PB09M	HEX BOLT M8-1.25 X 20
10	PR88M	INT RETAINING RING 8MM
11	P0742011	KNOB
12	P0742012	KNOB LEVER
13	P0742013	WISE LEADSCREW M18-2.5 X 257
14	P0742014	QUICK-RELEASE RATCHET
15	PRP93M	ROLL PIN 6 X 25
16	P0742016	CHAIN RETAINING SCREW M5-.8 X 25
17	P0742017	CHAIN
18	PLN03M	LOCK NUT M6-1
19	PW03M	FLAT WASHER 6MM
20	PS11M	PHLP HD SCR M6-1 X 16
21	P0742021	COTTER PIN 2 X 28
22	P0742022	OUTSIDE JAW
23	P0742023	JAW PIVOT PIN
24	P0742024	MOTOR BRUSH CAP
25	P0742025	MOTOR CARBON BRUSH
26	P0742026	MOTOR BRUSH HOLDER
27	P0742027	INSIDE JAW
28	PW04M	FLAT WASHER 10MM
29	PLW06M	LOCK WASHER 10MM
30	PB70M	HEX BOLT M10-1.5 X 16
31	PN02M	HEX NUT M10-1.5
32	PB20M	HEX BOLT M8-1.25 X 35
33	PN03M	HEX NUT M8-1.25
34	P0742034	STOP BOLT BRACKET
35	PW02M	FLAT WASHER 5MM
36	PLW01M	LOCK WASHER 5MM
37	PS08M	PHLP HD SCR M5-.8 X 12
38	PN01M	HEX NUT M6-1
39	P0742039	DUST SHIELD
40	PLW03M	LOCK WASHER 6MM
41	PS11M	PHLP HD SCR M6-1 X 16
42	P0742042	TORSION SPRING 5.7 X 30 X 40
43	P0742043	BOLT SLEEVE
44	P0742044	RUBBER SEAL
45	PB156M	HEX BOLT M10-1.5 X 150
46	PS09M	PHLP HD SCR M5-.8 X 10
47	P0742047	MOTOR REAR COVER
48	PS57M	PHLP HD SCR M5-.8 X 14
49	PS38M	PHLP HD SCR M4-.7 X 10
50	PLW02M	LOCK WASHER 4MM

REF	PART #	DESCRIPTION
51	PW05M	FLAT WASHER 4MM
52	P0742052	MOTOR HOUSING
53	P0742053	STOP BRACKET
54	PLW03M	LOCK WASHER 6MM
55	PS14M	PHLP HD SCR M6-1 X 12
56	P0742056	MOTOR STATOR
57	P6201ZZ	BALL BEARING 6201ZZ
58	P0742058	MOTOR ROTOR
59	P0742059	ROTOR HOUSING
60	P6202ZZ	BALL BEARING 6202ZZ
61	P0742061	ARBOR LOCK PIN
62	P0742062	COMPRESSION SPRING 0.6 X 6.7 X 26
63	P0742063	GEARBOX
64	P0742064	BLADE HOUSING
65	PS105M	PHLP HD SCR M5-.8 X 60
66	P0742066	BLADE GUARD
67	PS07M	PHLP HD SCR M4-.7 X 8
68	P0742068	BLADE GUARD BUMPER
69	P0742069	RUBBER WASHER 16.8 X 6.5 X 2
70	PFB01M	FLANGE BOLT M6-1 X 12
71	P629ZZ	BALL BEARING 629ZZ
72	PR08M	EXT RETAINING RING 19MM
73	P0742073	GEAR 42T
74	P0742074	FLANGED BEARING HOUSING
75	P6204-2RS	BALL BEARING 6204-2RS
76	P0742076	WOODRUFF KEY 4 X 6.5 X 15.7
77	P0742077	ARBOR
78	P0742078	ARBOR FLANGE
79	P0742079	ABRASIVE BLADE 14"
80	P0742080	FLANGE WASHER
81	PB74M	HEX BOLT M10-1.5 X 20
82	P0742082	WRENCH 16MM
83	PS94M	PHLP HD SCR M5-.8 X 75
84	PS74M	PHLP HD SCR M4-.7 X 14
85	PS54M	PHLP HD SCR M5-.8 X 45
86	PS22M	PHLP HD SCR M5-.8 X 25
87	PS60M	PHLP HD SCR M5-.8 X 30
88	PS06M	PHLP HD SCR M5-.8 X 20
89	P0742089	TRIGGER SWITCH, HELIN 16A
90	P0742090	LEFT HANDLE
91	PS02M	PHLP HD SCR M4-.7 X 12
92	P0742092	POWER CORD RETAINER
93	P0742093	STRAIN RELIEF
94	PN06M	HEX NUT M5-.8
95	P0742095	RIGHT HANDLE
96	P0742096	POWER CORD 14G 3W 5-15P
97	P0742097	MACHINE ID LABEL
98	P0742098	WARNING LABEL
99	P0742099	COMBO LABEL
100	PLABEL-14A	ELECTRICITY LABEL





WARRANTY CARD

Name _____
 Street _____
 City _____ State _____ Zip _____
 Phone # _____ Email _____
 Model # _____ Order # _____ Serial # _____

The following information is given on a voluntary basis. It will be used for marketing purposes to help us develop better products and services. **Of course, all information is strictly confidential.**

1. How did you learn about us?

<input type="checkbox"/> Advertisement	<input type="checkbox"/> Friend	<input type="checkbox"/> Catalog
<input type="checkbox"/> Card Deck	<input type="checkbox"/> Website	<input type="checkbox"/> Other:

2. Which of the following magazines do you subscribe to?

<input type="checkbox"/> Cabinetmaker & FDM	<input type="checkbox"/> Popular Science	<input type="checkbox"/> Wooden Boat
<input type="checkbox"/> Family Handyman	<input type="checkbox"/> Popular Woodworking	<input type="checkbox"/> Woodshop News
<input type="checkbox"/> Hand Loader	<input type="checkbox"/> Precision Shooter	<input type="checkbox"/> Woodsmith
<input type="checkbox"/> Handy	<input type="checkbox"/> Projects in Metal	<input type="checkbox"/> Woodwork
<input type="checkbox"/> Home Shop Machinist	<input type="checkbox"/> RC Modeler	<input type="checkbox"/> Woodworker West
<input type="checkbox"/> Journal of Light Cont.	<input type="checkbox"/> Rifle	<input type="checkbox"/> Woodworker's Journal
<input type="checkbox"/> Live Steam	<input type="checkbox"/> Shop Notes	<input type="checkbox"/> Other:
<input type="checkbox"/> Model Airplane News	<input type="checkbox"/> Shotgun News	
<input type="checkbox"/> Old House Journal	<input type="checkbox"/> Today's Homeowner	
<input type="checkbox"/> Popular Mechanics	<input type="checkbox"/> Wood	

3. What is your annual household income?

<input type="checkbox"/> \$20,000-\$29,000	<input type="checkbox"/> \$30,000-\$39,000	<input type="checkbox"/> \$40,000-\$49,000
<input type="checkbox"/> \$50,000-\$59,000	<input type="checkbox"/> \$60,000-\$69,000	<input type="checkbox"/> \$70,000+

4. What is your age group?

<input type="checkbox"/> 20-29	<input type="checkbox"/> 30-39	<input type="checkbox"/> 40-49
<input type="checkbox"/> 50-59	<input type="checkbox"/> 60-69	<input type="checkbox"/> 70+

5. How long have you been a woodworker/metalworker?

<input type="checkbox"/> 0-2 Years	<input type="checkbox"/> 2-8 Years	<input type="checkbox"/> 8-20 Years	<input type="checkbox"/> 20+ Years
------------------------------------	------------------------------------	-------------------------------------	------------------------------------

6. How many of your machines or tools are Grizzly?

<input type="checkbox"/> 0-2	<input type="checkbox"/> 3-5	<input type="checkbox"/> 6-9	<input type="checkbox"/> 10+
------------------------------	------------------------------	------------------------------	------------------------------

7. Do you think your machine represents a good value? Yes No

8. Would you recommend Grizzly Industrial to a friend? Yes No

9. Would you allow us to use your name as a reference for Grizzly customers in your area?
Note: We never use names more than 3 times. Yes No

10. Comments: _____

CUT ALONG DOTTED LINE

FOLD ALONG DOTTED LINE



Place Stamp Here



GRIZZLY INDUSTRIAL, INC.
P.O. BOX 2069
BELLINGHAM, WA 98227-2069



FOLD ALONG DOTTED LINE

Send a Grizzly Catalog to a friend:

Name _____
Street _____
City _____ State _____ Zip _____

TAPE ALONG EDGES--PLEASE DO NOT STAPLE

WARRANTY & RETURNS

Grizzly Industrial, Inc. warrants every product it sells for a period of **1 year** to the original purchaser from the date of purchase. This warranty does not apply to defects due directly or indirectly to misuse, abuse, negligence, accidents, repairs or alterations or lack of maintenance. This is Grizzly's sole written warranty and any and all warranties that may be implied by law, including any merchantability or fitness, for any particular purpose, are hereby limited to the duration of this written warranty. We do not warrant or represent that the merchandise complies with the provisions of any law or acts unless the manufacturer so warrants. In no event shall Grizzly's liability under this warranty exceed the purchase price paid for the product and any legal actions brought against Grizzly shall be tried in the State of Washington, County of Whatcom.

We shall in no event be liable for death, injuries to persons or property or for incidental, contingent, special, or consequential damages arising from the use of our products.

To take advantage of this warranty, contact us by mail or phone and give us all the details. We will then issue you a "Return Number," which must be clearly posted on the outside as well as the inside of the carton. We will not accept any item back without this number. Proof of purchase must accompany the merchandise.

The manufacturers reserve the right to change specifications at any time because they constantly strive to achieve better quality equipment. We make every effort to ensure that our products meet high quality and durability standards and we hope you never need to use this warranty.

Please feel free to write or call us if you have any questions about the machine or the manual.

Thank you again for your business and continued support. We hope to serve you again soon.

grizzly.com[®]

TOOL WEBSITE

Buy Direct and Save with Grizzly[®] – Trusted, Proven and a Great Value!
~Since 1983~

*Visit Our Website Today For
Current Specials!*

**ORDER
24 HOURS A DAY!
1-800-523-4777**

