



TOSHIBA



DVD VIDEO PLAYER SD-K740SU

OWNER'S MANUAL

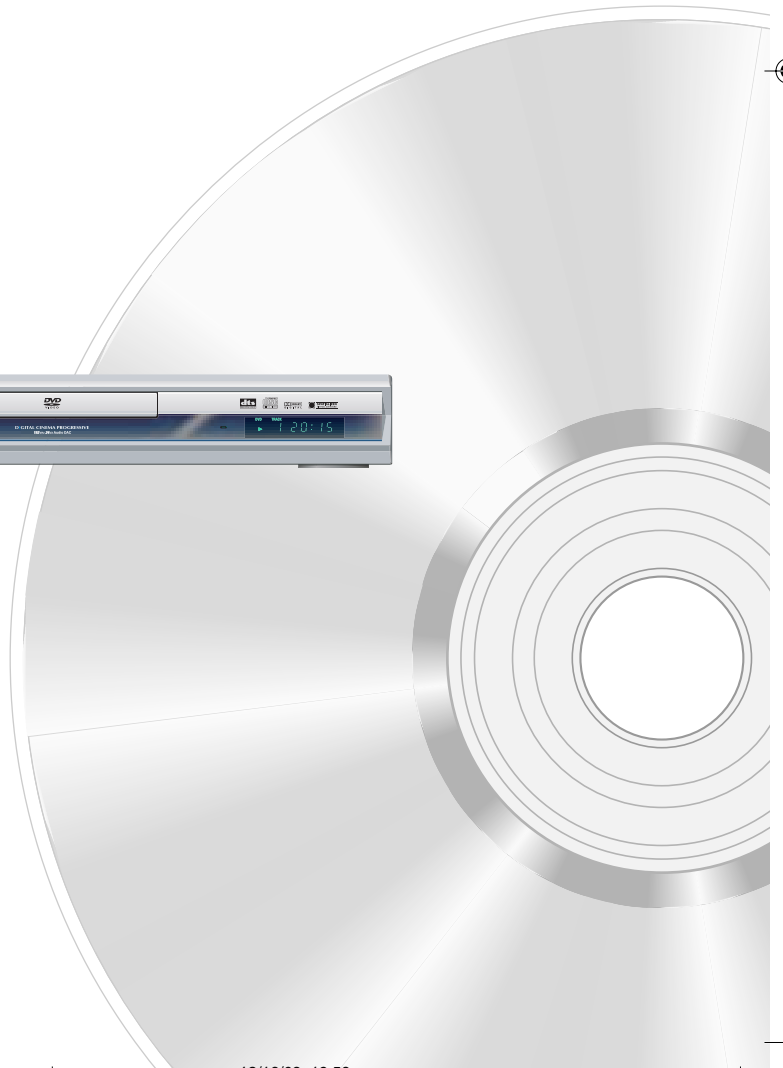

© 2004 Toshiba Corporation



SAFETY PRECAUTIONS

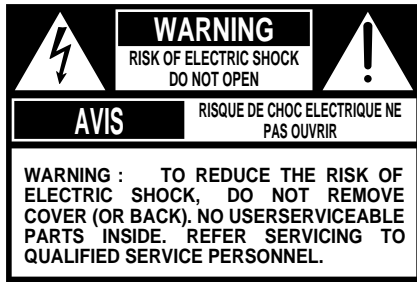

The lightning flash with arrowhead symbol, within an equilateral triangle, is intended to alert the user to the presence of uninsulated "dangerous voltage" within the product's enclosure that may be of sufficient magnitude to constitute a risk of electric shock to persons.



The exclamation point within an equilateral triangle is intended to alert the user to the presence of important operating and maintenance (servicing) instructions in the literature accompanying the appliance.

WARNING: TO REDUCE THE RISK OF FIRE OR ELECTRIC SHOCK, DO NOT EXPOSE THIS APPLIANCE TO RAIN OR MOISTURE. DANGEROUS HIGH VOLTAGES ARE PRESENT INSIDE THE ENCLOSURE. DO NOT OPEN THE CABINET. REFER SERVICING TO QUALIFIED PERSONNEL ONLY.

CAUTION: TO PREVENT ELECTRIC SHOCK, MATCH WIDE BLADE OF PLUG TO WIDE SLOT, FULLY INSERT.

ATTENTION: POUR EVITER LES CHOCS ELECTRIQUES, INTRODUIRE LA LAME LA PLUS LARGE DE LA FICHE DANS LA BORNE CORRESPONDANTE DE LA PRISE ET POUSSER JUSQU'AU FOND.

CAUTION: This Digital Video Disc Player employs a Laser System.
To ensure proper use of this product, please read this owner's manual carefully and retain for future reference. Should the unit require maintenance, contact an authorized service location - see service procedure.

Use of controls or adjustments or performance of procedures other than those specified herein may result in hazardous radiation exposure.

To prevent direct exposure to laser beam, do not try to open the enclosure.
Visible and invisible laser radiation when open and interlocks defeated.
DO NOT STARE INTO BEAM.

FCC NOTICE: This equipment has been tested and found to comply with the limits for a Class B digital device, pursuant to part 15 of the FCC Rule. These limits are designed to provide reasonable protection against harmful interference in a residential installation.

This equipment generates, uses, and can radiate radio frequency energy and, if not installed and used in accordance with the instructions, may cause harmful interference to radio communications. However, there is no guarantee that interference will not occur in a particular installation.

If this equipment does cause harmful interference to radio or television reception, which can be determined by turning the equipment off and on, the user is encouraged to try to correct the interference by one or more of the following measures:

- Reorient or relocate the receiving antenna.
- Increase the separation between the equipment and receiver.
- Connect the equipment into an outlet on a circuit different from that to which the receiver is connected.
- Consult the dealer or an experienced radio/TV technician for help.

WARNING: Changes or modifications made to this equipment, not expressly approved by Toshiba, or parties authorized by Toshiba, could void the user's authority to operate the equipment.

CAUTION: Servicing instructions are for use by qualified service personnel only. To reduce the risk of electric shock do not perform any servicing other than that contained in the operating instructions unless you are qualified to do so.

In the spaces provided below, record the Model and Serial No. located on the rear panel of your DVD video player.

Model No. _____

Serial No. _____

Retain this information for future reference.





IMPORTANT SAFEGUARDS

CAUTION: PLEASE READ AND OBSERVE ALL WARNINGS AND INSTRUCTIONS PROVIDED IN THIS OWNER'S MANUAL AND THOSE MARKED ON THE UNIT. RETAIN THIS BOOKLET FOR FUTURE REFERENCE.

This set has been designed and manufactured to assure personal safety. Improper use can result in electric shock or fire hazard. The safeguards incorporated in this unit will protect you if you observe the following procedures for installation, use and servicing. This unit is fully transistorized and does not contain any parts that can be repaired by the user.

DO NOT REMOVE THE CABINET COVER, OR YOU MAY BE EXPOSED TO DANGEROUS VOLTAGE. REFER SERVICING TO QUALIFIED SERVICE PERSONNEL ONLY.

1. Read these instructions.
2. Keep these instructions.
3. Heed all warnings.
4. Follow all instructions.

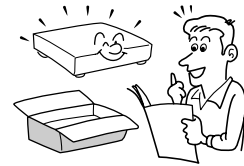

5. Do not use this apparatus near water.

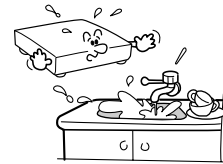

6. Clean only with dry cloth.



7. Do not block any ventilation openings. Install in accordance with the manufacturer's instructions.



8. Do not install near any heat sources such as radiators, heat registers, stoves, or other apparatus (including amplifiers) that produce heat.

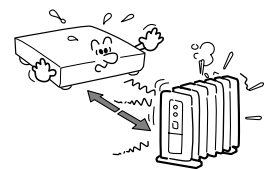

9. Do not defeat the safety purpose of the polarized or grounding-type plug. A polarized plug has two blades with one wider than the other. A grounding type plug has two blades and a third grounding prong. The wide blade or the third prong are provided for your safety. If the provided plug does not fit into your outlet, consult an electrician for replacement of the obsolete outlet.

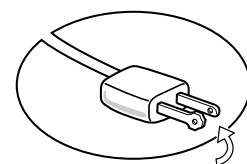



IMPORTANT SAFEGUARDS

(Continued)

10. Protect the power cord from being walked on or pinched particularly at plugs, convenience receptacles, and the point where they exit from the apparatus.



11. Only use attachments/accessories specified by the manufacturer.

12. Use only with the cart, stand, tripod, bracket, or table specified by the manufacturer, or sold with the apparatus. When a cart is used, use caution when moving the cart/apparatus combination to avoid injury from tip-over.



13. Unplug this apparatus during lightning storms or when unused for long periods of time.



14. Refer all servicing to qualified service personnel. Servicing is required when the apparatus has been damaged in any way, such as power-supply cord or plug is damaged, liquid has been spilled or objects have fallen into the apparatus, the apparatus has been exposed to rain or moisture, does not operate normally, or has been dropped.

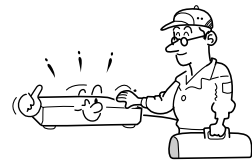

15. When you use headphones on the amplifier, keep the volume at a moderate level. If you use the headphones continuously with high volume sound, it may cause hearing damage.





16. Do not overload wall outlets; extension cords, or integral convenience receptacles as this can result in a risk of fire or electric shock.

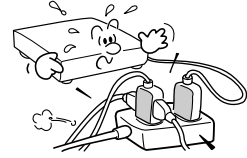

17. Never insert objects of any kind into this apparatus through openings as they may touch dangerous voltage points or short-out parts that could result in a fire or electric shock. Never spill liquid of any kind on the apparatus.



18. Keep your fingers well clear of the disc tray as it is closing. Neglecting to do so may cause serious personal injury.



19. Do not place a heavy object on or step on the apparatus. The object may fall, causing serious personal injury and serious damage to the apparatus.

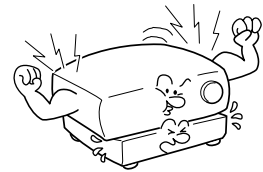

20. Do not use a cracked, deformed, or repaired disc. These discs are easily broken and may cause serious personal injury and apparatus malfunction.

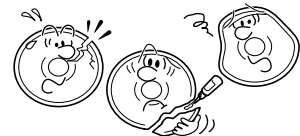

Precautions

Notes on handling

- When shipping the DVD video player, the original shipping carton and packing materials come in handy. For maximum protection, repack the unit as it was originally packed at the factory.
- Do not use volatile liquids, such as insect spray, near the DVD video player. Do not leave rubber or plastic products to contact the DVD video player for prolonged period. They will leave marks on the finish.
- The top and rear panels of the DVD video player may become warm after a long period of use. This is not a malfunction.
- When the DVD video player is not in use, be sure to remove the disc and turn off the power.
- If you do not use the DVD video player for a long period, the unit may not function properly in the future. Turn on and use the DVD video player occasionally.

Notes on locating

- Place the DVD video player on a level surface. Do not use it on a shaky or unstable surface such as a wobbling table or inclined stand. The loaded disc may become dis-aligned and damage the DVD video player.
- When you place this DVD video player near a TV, radio, or VCR, the playback picture may become poor and the sound may be distorted. In this case, place the DVD video player away from the TV, radio, or VCR.

Notes on cleaning

Use a soft, dry cloth for cleaning.

- For stubborn dirt, soak the cloth in a weak detergent solution, wring well and wipe. Use a dry cloth to wipe it dry.
Do not use any type of solvent, such as thinner and benzene, as they may damage the surface of the DVD video player.
- If you use a chemical saturated cloth to clean the unit, follow that product's instructions.

To obtain a clear picture

The DVD video player is a high technology, precision device. If the optical pick-up lens and disc drive parts are dirty or worn down, the picture quality will deteriorate. To obtain a clear picture, we recommend regular inspection and maintenance (cleaning or parts replacement) every 1,000 hours of use depending on the operating environment. For details, contact your nearest dealer.

Notes on moisture condensation

Moisture condensation damages the DVD video player. Please read the following carefully.

Moisture condensation occurs, for example, when you pour a cold drink into a glass on a warm day. Drops of water form on the outside of the glass. In the same way, moisture may condense on the optical pick-up lens inside this unit, one of the most crucial internal parts of the DVD video player.

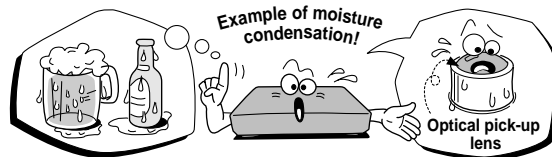

■ **Moisture condensation occurs during the following cases.**

- When you bring the DVD video player directly from a cold place to a warm place.
- When you use the DVD video player in a room where you just turned on the heater, or a place where the cold wind from the air conditioner directly hits the unit.
- In summer, when you use the DVD video player in a hot and humid place just after you move the unit from an air conditioned room.
- When you use the DVD video player in a humid place.

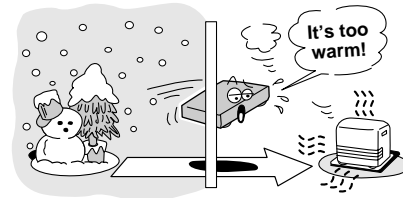

■ **Do not use the DVD video player when moisture condensation may occur.**

If you use the DVD video player in such a situation, it may damage discs and internal parts. Remove the disc, connect the power cord of the DVD video player to the wall outlet, turn on the DVD video player, and leave it for two or three hours. After two or three hours, the DVD video player will have warmed up and evaporated any moisture. Keep the DVD video player connected to the wall outlet and moisture condensation will seldom occur.

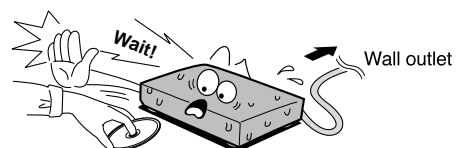



Notes on discs

On handling discs

- Do not touch the playback side of the disc.

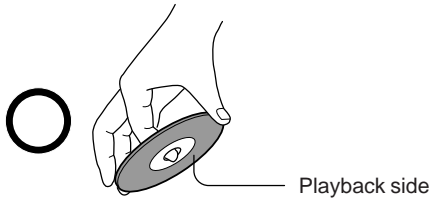

- Do not attach paper or tape to discs.



On cleaning discs

- Fingerprints and dust on the disc cause picture and sound deterioration. Wipe the disc from the center outwards with a soft cloth. Always keep the disc clean.

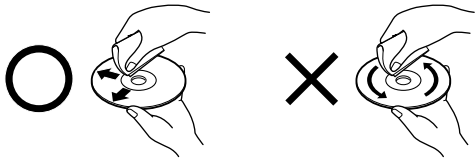

- If you cannot wipe off the dust with a soft cloth, wipe the disc lightly with a slightly moistened soft cloth and finish with a dry cloth.
- Do not use any type of solvent such as thinner, benzene, commercially available cleaners or antistatic spray for vinyl LPs. It may damage the disc.

On storing discs

- Do not store discs in a place subject to direct sunlight or near heat sources.
- Do not store discs in places subject to moisture and dust such as a bathroom or near a humidifier.
- Store discs vertically in a case. Stacking or placing objects on discs outside of their case may cause warping.

Structure of disc contents

Normally, DVD video discs are divided into titles, and the titles are sub-divided into chapters. Video CDs and Audio CDs are divided into tracks.

DVD video disc

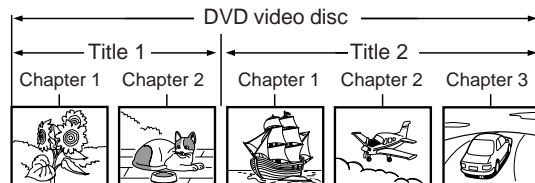

Video CD/Audio CD

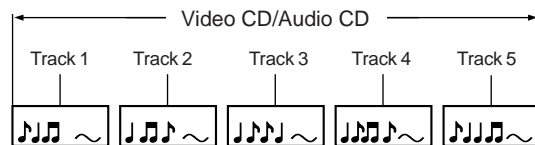

Each title, chapter or track is assigned a number, which is called "title number", "chapter number" or "track number" respectively.

There may be discs that do not have these numbers.

Notes on copyright

It is forbidden by law to copy, broadcast, show, broadcast on cable, play in public, and rent copyrighted material without permission.





DVD video discs are copy protected, and any recordings made from these discs will be distorted.

This product incorporates copyright protection technology that is protected by method claims of certain U.S. patents and other intellectual property rights owned by Macrovision Corporation and other rights owners. Use of this copyright protection technology must be authorized by Macrovision Corporation, and is intended for home and other limited viewing uses only unless otherwise authorized by Macrovision Corporation. Reverse engineering or disassembly is prohibited.



Notes on discs (continued)

About this owner's manual

This owner's manual explains the basic instructions of this DVD video player. Some DVD video discs are produced in a manner that allows specific or limited operation during playback. As such, the DVD may not respond to all operating commands. This is not a defect in the DVD. Refer to instruction notes of discs.

“” may appear on the TV screen during operation. A “” means that the operation is not permitted by the DVD or the disc. For example, sometimes it is unable to stop the playback of copyright message of the disc when the STOP () button is pressed. Alternatively, the “” may also indicate that the feature is not available for the disc.

Notes on region numbers

The region number of this DVD is 1. If region numbers, which stand for their playable area, are printed on your DVD video disc and you do not find  or , disc playback will not be allowed by the player. (In this case, the DVD will display a message on-screen.)

On Video CDs

This DVD supports Video CDs equipped with the PBC (Version 2.0) function. (PBC is the abbreviation of Playback Control.) You can enjoy two playback variations depending on types of discs.

- **Video CD not equipped with PBC function (Version 1.1)**
Sound and movie can be played on this unit in the same way as an audio CD.
- **Video CD equipped with PBC function (Version 2.0)**
In addition to operation of a Video CD not equipped with the PBC function, you can enjoy playback of interactive software with search function by using the menu displayed on the TV screen (Menu Playback). Some of the functions described in this owner's manual may not work with some discs.

Playable discs

This DVD video player can play the following discs.

	Disc Mark	Contents	Disc Size	Maximum playback time
DVD video discs		Audio + Video (moving pictures)	12 cm	Approx. 4 hours (single sided disc) Approx. 8 hours (double sided disc)
			8 cm	Approx. 80 minutes (single sided disc) Approx. 160 minutes (double sided disc)
Video CDs		Audio + Video (moving pictures)	12 cm	Approx. 74 minutes
			8 cm	Approx. 20 minutes
Audio CDs		Audio	12 cm	Approx. 74 minutes
			8 cm (CD single)	Approx. 20 minutes

The following discs are also available.

- DVD-R/RW discs of DVD video format
 - CD-R/CD-RW discs of CD-DA, Video CD, SVCD, MP3, WMA or JPEG format
 - Kodak Picture CD and FUJICOLOR CD format
- Some of these discs may be incompatible.

- You cannot play discs other than those listed above.
- You cannot play discs of DVD-RAM, DVD-ROM, Photo CD, etc., or non standardized discs even if they may be labeled as above.
- Some CD-R/RWs can not be played back depending on the recording conditions.
- This unit uses the NTSC color system, and cannot play DVD video discs recorded in any other color system (PAL, SECAM, etc.).



Table of contents

Introduction

- SAFETY PRECAUTIONS 2
- IMPORTANT SAFEGUARD 3
- Precautions 6
- Notes on discs 7
- Table of contents 9
- Identification of controls 10
 - Front panel 10
 - Rear panel 10
 - FL display 11
 - Remote control 12
 - Loading batteries 13
 - Operating with the remote control 13

Connections

- Connecting to a TV 14
 - Connecting to a TV 14
 - Connecting to an audio system and TV equipped with component video inputs 15
- Connecting to optional equipment 16
 - Connecting to an amplifier equipped with a Dolby Digital decoder 16
 - Connecting to an amplifier equipped with Dolby Pro Logic Surround 16
 - Connecting to an amplifier equipped with a DTS decoder 16
 - Connecting to an amplifier equipped with an MPEG2 audio decoder 17
 - Connecting to an amplifier equipped with a digital audio input 17

Basic playback

- Playing a disc 18
 - Basic playback 18
 - Playing in fast reverse or fast forward directions . 20
 - Playing fram by frame 20
 - Playing in slow-motion 20
 - Locating a chapter or track 20

Advanced playback

- Zooming 21
- Locating desired scene 21
- Marking the scenes 22
- Returning to the scenes 22
- Repeat playback 23
 - A-B Repeat playback 23
- Program playback 24
- Random playback 24
- Changing angles 25
- Title selection 25
- DVD menu 25
- Changing soundtrack language 26
- Setting surround sound 26
- Subtitles 27
- Karaoke playback 27
- Disc status 28
- To turn off the PBC 28
- MP3/WMA/JPEG operation 29
 - MP3/WMA/JPEG information 29
 - MP3/WMA/JPEG playback 30
 - JPEG CD playback 31
 - Slide show playback 31
- Selecting PROGRESSIVE scan 32

Function setup

- Customizing the function settings 33
 - Setting procedure 33
 - Setting details 34
- Temporary disabling of rating level by DVD disc 38
- Language code list 39
- Multi brand remote control 40
 - Setting TV control codes 40
 - Table of TV brand codes 40

Others

- Troubleshooting guide 41
- Specifications 42
- LIMITED WARRANTY DVD VIDEO PLAYER 43



Identification of controls

See the page in for details.

Front panel

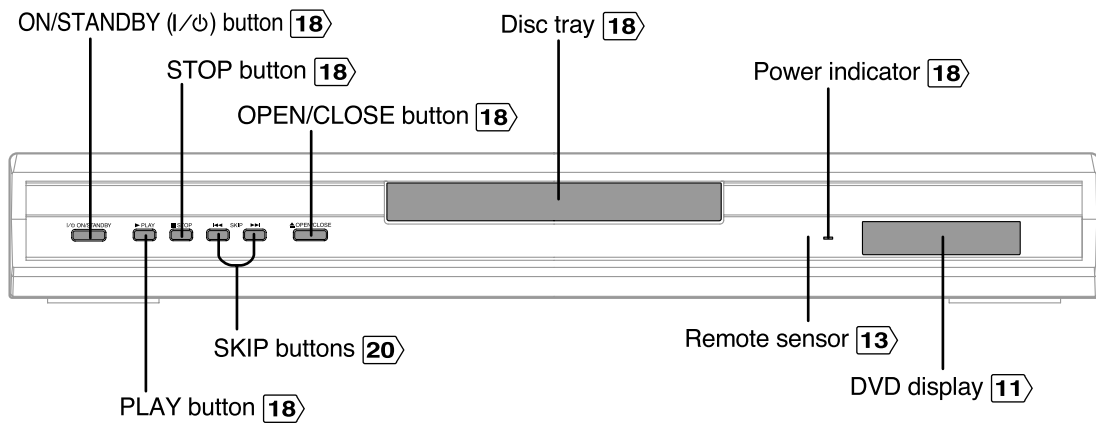

Rear panel

When connecting the optical digital cable, remove the cap and fit the connector into the jack firmly. When not using the jack, keep the cap inserted to protect it from dust intrusion.

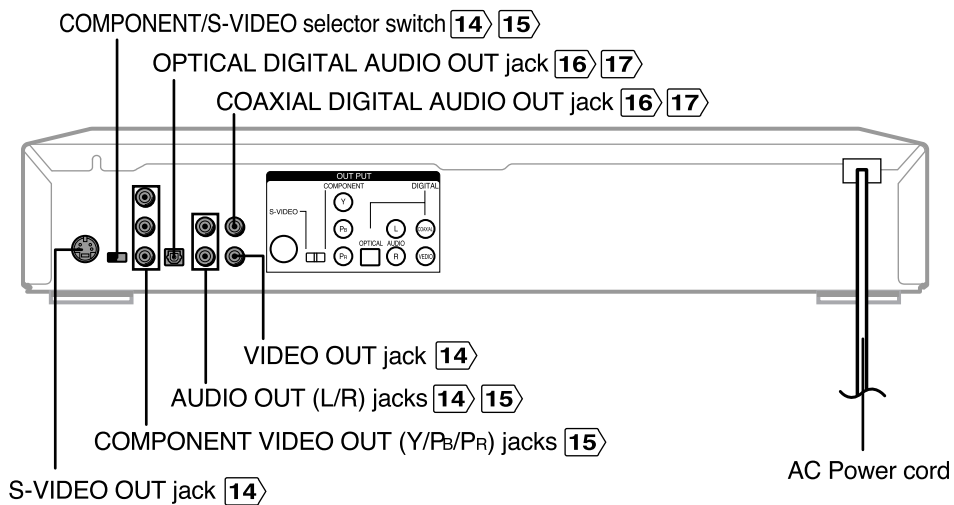
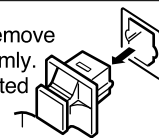



FL display

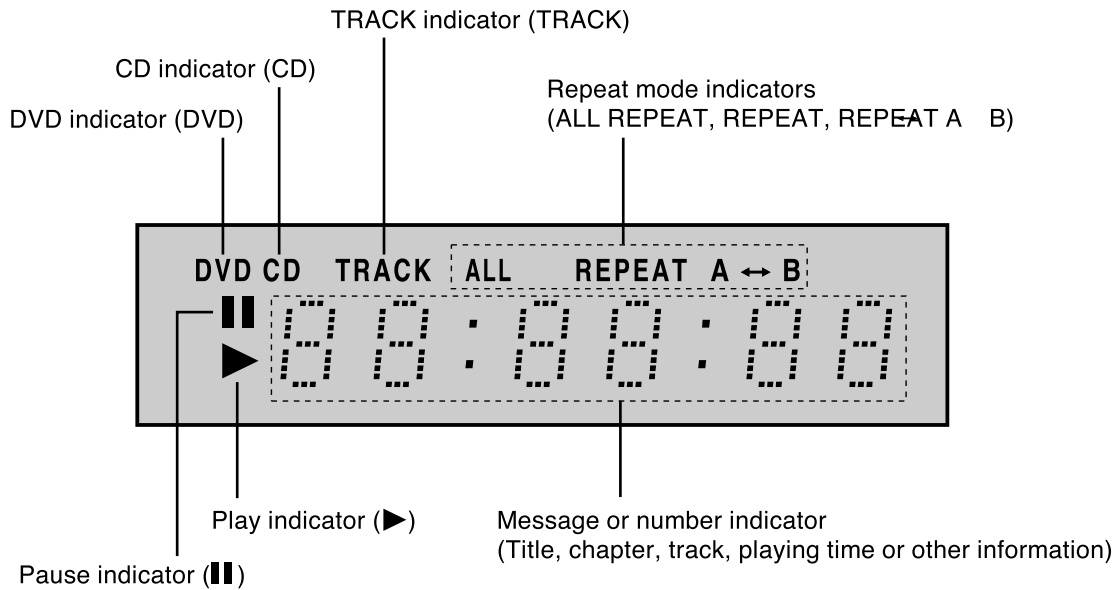

■ Dimmer function

This function will change the brightness of the FL display during Power-on status.

1. Press **FL DIM** once to dim the FL display.
2. Press **FL DIM** twice to turn off the FL display.
3. Press **FL DIM** third times to turn on the FL display.

The display may vary depending on the types of discs you play.

DVD video disc	Video CD	Audio CD
<ul style="list-style-type: none"> • During playback: 	<ul style="list-style-type: none"> • During playback: 	<ul style="list-style-type: none"> • During playback:
<p>Example</p>	<p>Example</p> <p>Playing track 1</p>	<p>Example</p> <p>Playing track 6</p>
<p>Some discs may not display elapsed time.</p>	<p>Some discs may not display track numbers or elapsed time.</p>	<p>Some discs may not display track numbers or elapsed time.</p>



Identification of controls (continued)

The instructions in this manual describe the functions on the remote control. See the page in for details.

Remote control

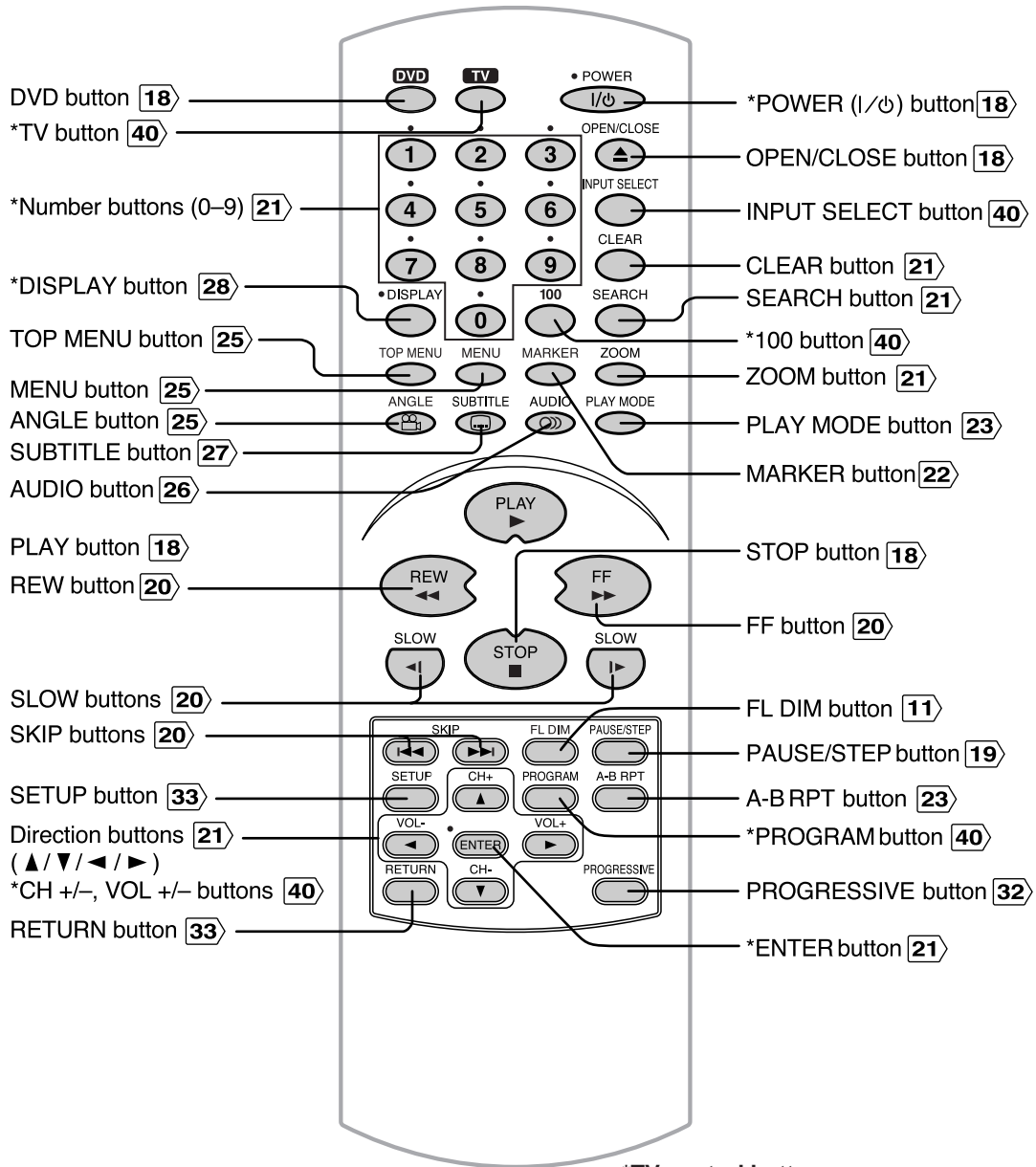

MENU button

Use the MENU button to display the menu included on many DVD video discs. To operate a menu, follow the instructions in "DVD menu." 25

***TV control buttons**

The various brands of TV listed on page 40 can be operated with this remote control. There may be some TV models that cannot be operated with this remote control. If this is the case, use the original remote control supplied with the TV.



Loading batteries

- 1** Slide the battery compartment cover in the direction of the arrow.

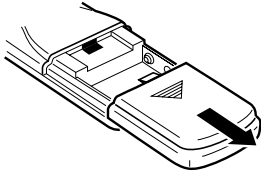

- 2** Install two "AAA" batteries (supplied), paying attention to the polarity diagram in the battery compartment.

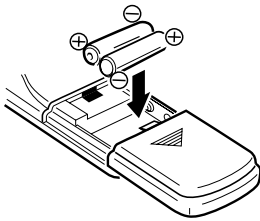

- 3** Replace the compartment cover.

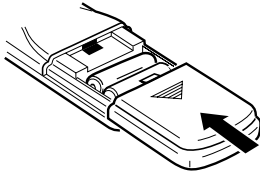

Notes on batteries

Improper use of batteries may cause battery leakage and corrosion. To operate the remote control correctly, follow the instructions below.

- Do not insert batteries into the remote control in the wrong direction.
- Do not charge, heat, open, or short-circuit the batteries. Do not throw batteries into a fire.
- Do not leave dead or exhausted batteries in the remote control.
- Do not use different types of batteries together, or mix old and new batteries.
- If you do not use the remote control for a long period of time, remove the batteries to avoid possible damage from battery corrosion.
- If the remote control does not function correctly or if the operating range becomes reduced, replace all batteries with new ones.
- If battery leakage occurs, wipe the battery liquid from the battery compartment, then insert new batteries.

Operating with the remote control

Point the remote control at the remote sensor and press the buttons.

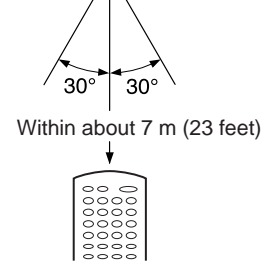
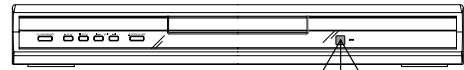

Distance: About 7 m (23 feet) from the front of the remote sensor

Angle: About 30° in each direction of the front of the remote sensor

* Do not expose the remote sensor of the DVD video player to a strong light source such as direct sunlight or other illumination. If you do so, you may not be able to operate the DVD video player via the remote control.

Notes on the remote control

- Direct the remote control at the remote sensor of the DVD video player.
- Do not drop or give the remote control a shock.
- Do not leave the remote control near an extremely hot or humid place.
- Do not spill water or put anything wet on the remote control.
- Do not disassemble the remote control.
- When using the remote control, press the button at intervals of about 1 second to ensure the correct mode of operation.

Connecting to a TV

Connect the DVD video player to your TV.

Connecting to a TV

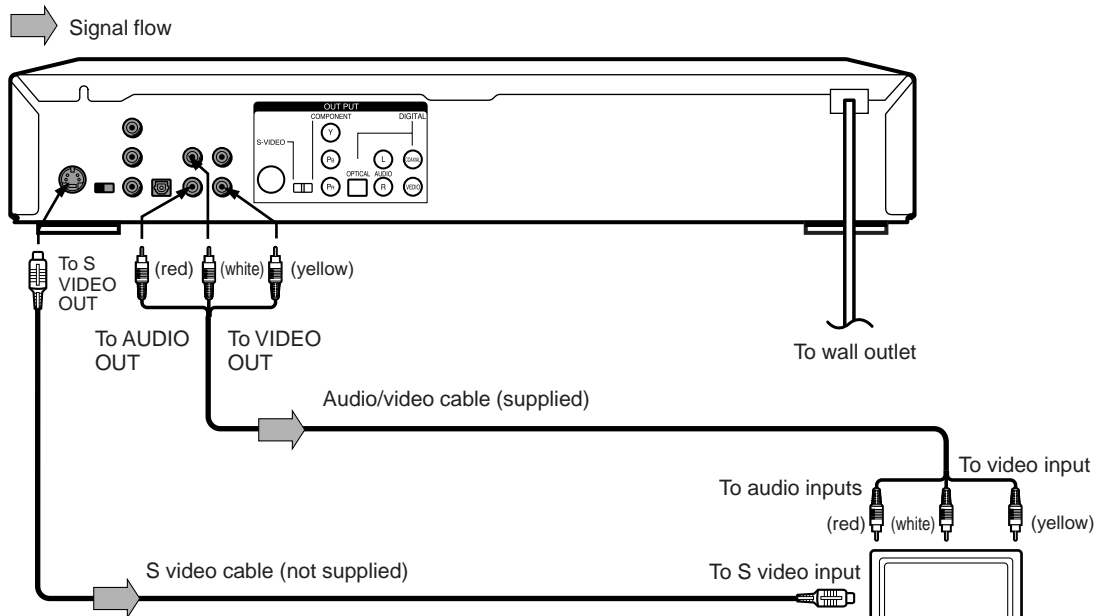

If the TV has an S video input, connect the DVD video player with an S video cable. When using an S video cable, do not connect the yellow video cable. Set the COMPONENT/S-VIDEO selector switch to the S-VIDEO position.

Notes:

- Refer to the owner's manual of the connected TV as well.
- When you connect the DVD video player to your TV, be sure to turn off the power and unplug both units from the wall outlet before making any connections.
- If your television set has one audio input, connect the left and right audio outputs of the DVD video player to a Y cable adapter (not supplied) and then connect to your TV.
- Connect the DVD video player directly to your TV. If you connect the DVD video player to a VCR, TV/VCR combination or video selector, the playback picture may be distorted as DVD video discs are copy protected.



Component video outputs/inputs

■ PROGRESSIVE outputs/inputs

Some TVs or monitors are equipped with component video inputs that are capable of reproducing a progressively scanned video signal. Connecting to these inputs allows you to view the highest quality pictures with less flicker.

■ INTERLACED outputs/inputs

Some TVs or monitors are equipped with component video inputs. Connecting to these inputs allows you to enjoy the highest quality DVD picture playback.

Connecting to an audio system and TV equipped with component video inputs

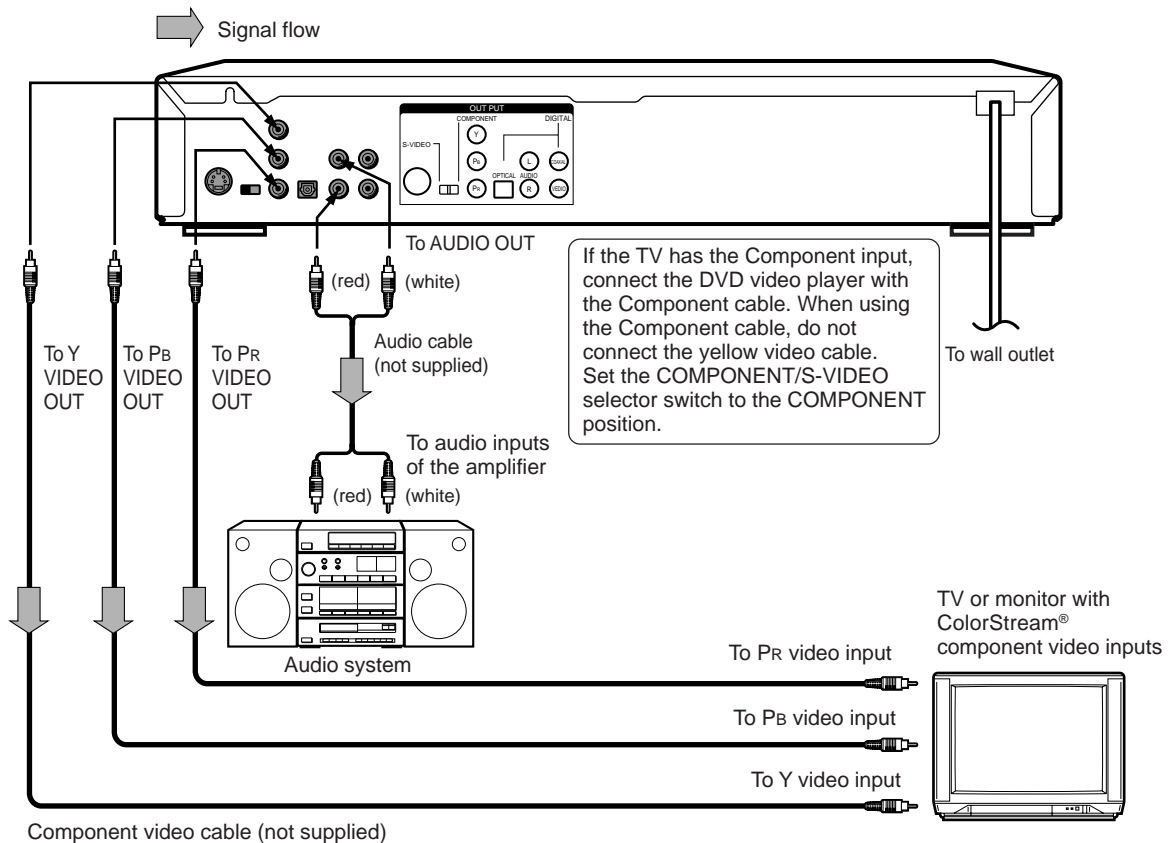

Notes:

- Actual labels for component video inputs may vary depending on the TV manufacturer. (ex. Y, R-Y, B-Y or Y, CB, CR)
- In some TVs or monitors, the color levels of the playback picture may be reduced slightly or the tint may change. In such a case, adjust the TV or monitor for optimum performance.

Notes:

- Refer to the owner's manual of the connected equipment as well.
- When you connect the DVD video player to other equipment, be sure to turn off the power and unplug all of the equipment from the wall outlet before making any connections.
- If you place the DVD video player near a tuner or radio, the radio broadcast sound might be distorted. In this case, place the DVD video player away from the tuner and radio.
- The output sound of the DVD video player has a wide dynamic range. Be sure to adjust the receiver's volume to a moderate listening level. Otherwise, the speakers may be damaged by a sudden high volume sound.
- Turn off the amplifier before you connect or disconnect the DVD video player's power cord. If you leave the amplifier power on, the speakers may be damaged.
- **When connecting to a TV using the Video or S-video jack, do not set the COMPONENT/S-VIDEO selector switch to the COMPONENT position and make the Progressive scan mode On with the PROGRESSIVE button. If you do it, the Video and S-video outputs do not feed the correct signals and you cannot see any picture. To turn off the Progressive scan mode, select PROGRESSIVE scan Off (see page 32).**



Connecting to optional equipment

You can enjoy high quality dynamic sounds by connecting the DVD video player to optional audio equipment.

For connection to your TV, see "Connecting to a TV" 14 15.

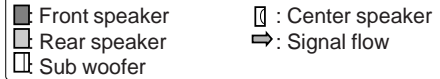

Connecting to an amplifier equipped with a Dolby Digital decoder

Dolby Digital

Dolby Digital is the surround sound technology used in theaters showing the latest movies, and is now available to reproduce this realistic effect in the home. You can enjoy motion picture and live concert DVD video discs with this dynamic realistic sound by connecting the DVD video player to a 6 channel amplifier equipped with a Dolby Digital decoder or Dolby Digital processor. If you have a Dolby Pro Logic Surround decoder, you will obtain the full benefit of Pro Logic from the same DVD movies that provide full 5.1-channel Dolby Digital soundtracks, as well as from titles with the Dolby Surround mark.

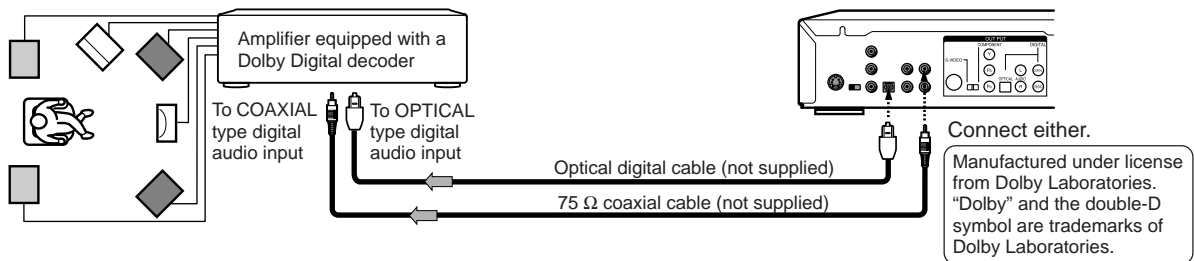

Connecting to an amplifier equipped with Dolby Pro Logic Surround

Dolby Pro Logic Surround

You can enjoy the dynamic realistic sound of Dolby Pro Logic Surround by connecting an amplifier and speaker system (right and left front speakers, a center speaker, and one or two rear speakers).

- With an amplifier equipped with Dolby Digital Connect the equipment the same way as described in "Connecting to an amplifier equipped with a Dolby Digital decoder." Refer to that amplifier's owner's manual and set the amplifier so you can enjoy Dolby Pro Logic Surround sound.
- With an amplifier not equipped with Dolby Digital Connect the equipment as follows.

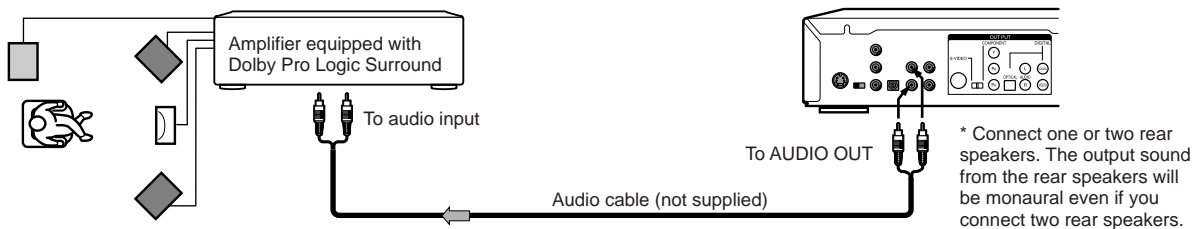

Connecting to an amplifier equipped with a DTS decoder

Digital Theater Systems (DTS)

DTS is a high quality surround technology used in theaters and now available for home use, on DVD video discs or audio CDs. If you have a DTS decoder or processor, you can obtain the full benefit of 5.1 channel DTS encoded sound tracks on DVD video discs or audio CDs.

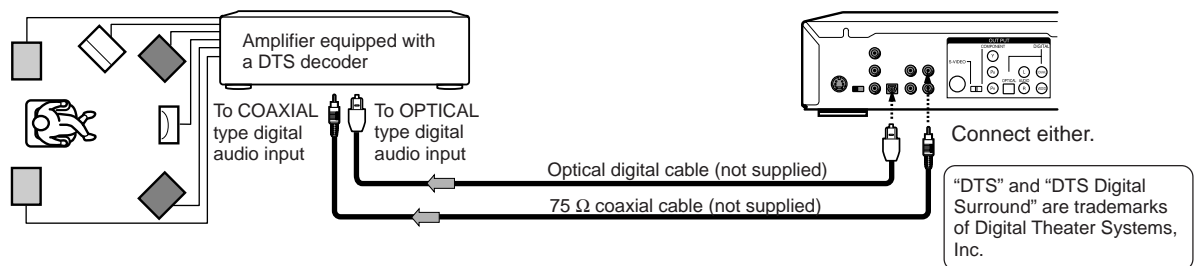



Warning

- When playing DTS-encoded discs (DVD video discs and audio CDs), excessive noise may be output from the analog stereo jacks. To avoid possible damage to the audio system, you should take proper precautions when the AUDIO OUT (L/R) jacks of the DVD video player are connected to an amplification system. (Do not leave the ANALOG AUDIO OUT (L/R) cables dangling.) To enjoy DTS Digital Surround™ playback, an external 5.1 channel DTS Digital Surround™ decoder system must be connected to the OPTICAL DIGITAL AUDIO OUT jack or COAXIAL DIGITAL AUDIO OUT jack of the DVD video player.

Connecting to an amplifier equipped with an MPEG2 audio decoder

MPEG2 sound

You can enjoy motion picture and live concert DVD video discs with dynamic realistic sound by connecting an amplifier equipped with an MPEG2 audio decoder or MPEG2 audio processor.

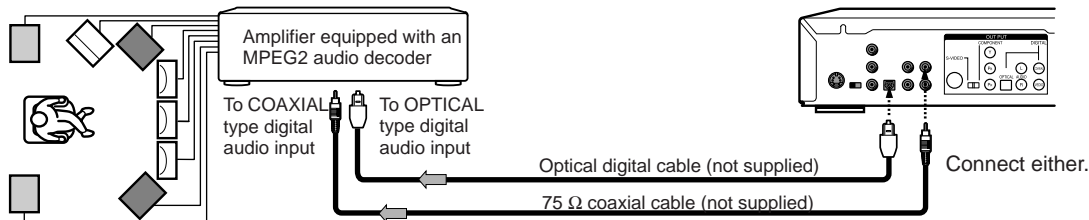

Connecting to an amplifier equipped with a digital audio input

2 channel digital stereo

You can enjoy the dynamic sound of 2 channel digital stereo by connecting an amplifier equipped with a digital audio input and speaker system (right and left front speakers).

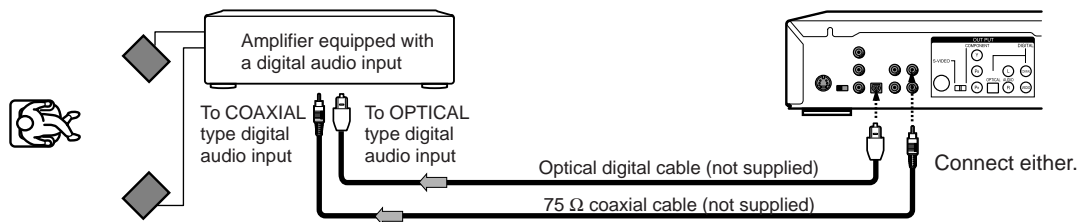

Notes:

- DO NOT connect the OPTICAL DIGITAL AUDIO OUT jack or COAXIAL DIGITAL AUDIO OUT jack of the DVD video player to the AC-3 RF input of a Dolby Digital Receiver. This input on your A/V Receiver is reserved for Laserdisc use only and is incompatible with the OPTICAL DIGITAL AUDIO OUT jack or COAXIAL DIGITAL AUDIO OUT jack of the DVD video player.
- Connect the OPTICAL DIGITAL AUDIO OUT jack or COAXIAL DIGITAL AUDIO OUT jack of the DVD video player to the "OPTICAL" or "COAXIAL" input of a Receiver or Processor.
- Refer to the owner's manual of the connected equipment as well.
- When you connect the DVD video player to other equipment, be sure to turn off the power and unplug all of the equipment from the wall outlet before making any connections.
- The output sound of the DVD video player has a wide dynamic range. Be sure to adjust the receiver's volume to a moderate listening level. Otherwise, the speakers may be damaged by a sudden high volume sound.
- Turn off the amplifier before you connect or disconnect the DVD video player's power cord. If you leave the amplifier power on, the speakers may be damaged.



Playing a disc

This section shows you the basics on how to play a disc.

CAUTION
Keep your fingers well clear of the disc tray as it is closing. Neglecting to do so may cause serious personal injury.

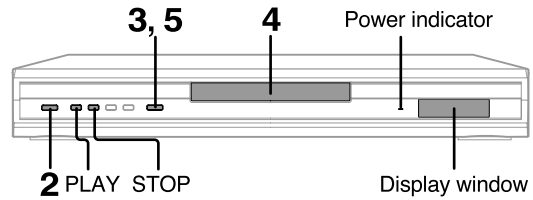

DVD VCD CD Basic playback

Preparations:

- When you want to view a disc, turn on the TV and select the corresponding video input connected to the DVD. This may include S-video or component video inputs which are exclusive to DVD playback.
- When you want to enjoy the sound of discs from the audio system, turn on the audio system and select the input connected to the DVD.

1 Press DVD on the remote control to operate the DVD video player.

2 Press ON/STANDBY (I / ⏻).

 The DVD turns on and the Power indicator lights. "Reading" display will change to "No Disc". (If DVD disc has already loaded, playback will start automatically.)





3 Press OPEN/CLOSE.

 The disc tray opens.

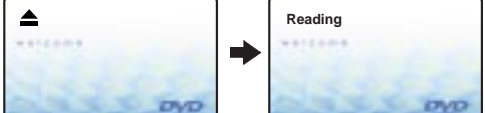

4 Place the disc on the disc tray.

 With the playback side down

- There are two different disc sizes. Place the disc in the correct guide on the disc tray. If the disc is out of the guide, it may damage the disc and cause the DVD to malfunction.
- Do not place a disc which is unplayable in this DVD.

5 Press OPEN/CLOSE or PLAY on the unit.

 OR

 The disc tray closes automatically. On the TV-screen, "▲" changes to "Reading" and then playback commences.

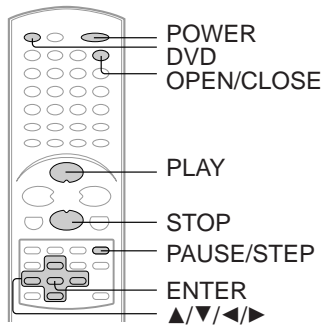
 • A menu screen will appear on the TV screen, if the disc has a menu feature. Press ▲/▼ or ◀/▶ to select title, then press ENTER. Title is selected and play commences.

6 Press STOP to end playback.

■ Resuming facility
 • The unit records the stopped point, depending on the disc. "■" appears on the screen. Press PLAY to resume playback (from the scene point).
 • If you press STOP again or unload the disc ("■" appears on the screen.), the unit will clear the stopped point.

■ To start playback in the stop mode
 Press PLAY.



■ To obtain a higher quality picture

Occasionally, some picture noise not usually visible during a normal broadcast may appear on the TV screen while playing a DVD video disc because the high resolution pictures on these discs include a lot of information. While the amount of noise depends on the TV you use with this unit, you should generally reduce the sharpness adjustment on your TV when viewing DVD video discs.

■ About

The icons on the heading bar show the playable discs for the function described under that heading.

: You can use this function with DVD video discs.

: You can use this function with Video CDs.

: You can use this function with Audio CDs and CD-R/RW CDs.

■ To pause playback (still mode)

Press **PAUSE/STEP** during playback.



To resume normal playback, press **PLAY**.

- The sound is muted during still mode.

■ To remove the disc

Press **OPEN/CLOSE**.

OPEN/CLOSE



Remove the disc after the disc tray opens completely.

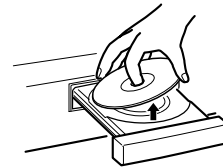

Be sure to press **OPEN/CLOSE** to close the disc tray after you remove the disc.

■ To stop playback

Press **STOP**.



■ Screen saver function

The screen saver operates when you leave the unit in DVD stop mode for approx. five minutes. The screen will repeatedly get dark gradually and back to normal.

Notes:

- If a non-compatible disc is loaded, "Incorrect Disc", "Region Code Error" or "Parental Error" will appear on the TV screen according to the type of loaded disc. In this case, check your disc again (see pages 8 and 37).
- Some discs may take a minute or so to start playback.
- When you set a single-faced disc label downwards (ie. the wrong way up) and press the OPEN/CLOSE button or the PLAY button on the unit, "Reading" will appear on the display for 30 seconds and then "Incorrect Disc" will continue to be displayed.
- Some discs may not work the resuming facility.
- Resuming cannot function when you play a PBC-featured Video CD while the PBC is on. To turn off the PBC, see page 28.
- Some playback operations of DVDs may be intentionally fixed by software producers. Since this unit plays DVDs according to the disc contents the software producers designed, some playback features may not be available. Also refer to the instructions supplied with the DVDs.
- Do not move the unit during playback. Doing so may damage the disc.
- Use the OPEN/CLOSE button to open and close the disc tray. Do not push the disc tray while it is moving. Doing so may cause the unit to malfunction.
- Do not push up on the disc tray or put any objects other than discs on the disc tray. Doing so may cause the unit to malfunction.
- In many instances, a menu screen will appear after playback of a movie is completed. Prolonged display of an on-screen menu may damage your television set, permanently etching that image onto its screen. To avoid this, be sure to press the ON/STANDBY (I / U) button on your remote control once the movie is completed.
- There may be a slight delay between you pressing the button and the function activating.



Playing a disc (continued)

You can play discs at various speeds.

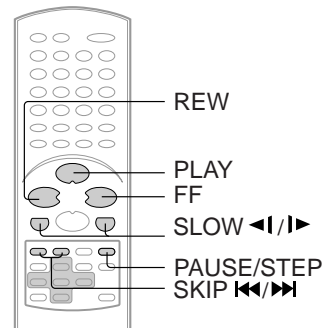

DVD VCD CD Playing in fast reverse or fast forward directions

Press REW or FF during playback.



REW: Fast reverse playback
FF: Fast forward playback

Each time you press the REW or FF button, the playback speed changes.

To resume normal playback

Press **PLAY**.



Notes:

- The DVD video player mutes sound and subtitles during reverse and forward scan of DVD/VCD video discs. However, this unit plays sound during fast forward or fast reverse play of audio CDs.
- The playback speed may differ depending on the disc.

DVD VCD Playing frame by frame

Press PAUSE/STEP during still playback.



Each time you press the PAUSE/STEP button, the picture advances one frame.

To resume normal playback

Press **PLAY**.



Notes:

- The sound is muted during frame by frame playback.

DVD VCD Playing in slow-motion

Press SLOW (right arrow) Forward or SLOW (left arrow) Reverse during playback.

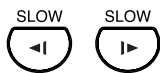

Each time you press the button, the slow-motion speed changes.

To resume normal playback

Press **PLAY**.



Notes:

- The sound is muted during slow-motion playback.
- The Video CD can not play Reverse Slow.

DVD VCD CD Locating a chapter or track

Press SKIP (left arrow) or (right arrow) repeatedly to display the chapter or track number you want.

Playback starts from the selected chapter or track.



To locate succeeding chapters or tracks.



Playback starts from the beginning of the current chapter or track. When you press twice in quick successions, playback starts from the beginning of the preceding chapter or track.

Notes:

- A "Prohibition" symbol (hand with slash) may appear at the upper left of the screen. This symbol means either the feature you tried is not available on the disc, or the DVD can not access the feature at this time. This does not indicate a problem with the DVD.
- The unit is capable of holding a still video image or On screen display image on your television screen indefinitely. If you leave the still video image or On screen display image displayed on your TV for an extended period of time, you risk permanent damage to your television screen. Projection televisions are very susceptible.

Zooming/Locating desired scene

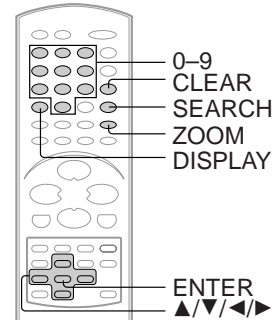

Zooming

This unit will allow you to zoom in on the frame image. You can then make selections by switching the position of the frame.

1 Press ZOOM during playback.

ZOOM

The centre part of the image will be zoomed in. Each press of **ZOOM** will change the ZOOM Q1 (x 1.3), Q2 (x 1.5) and Q3 (x 2.0).

2 Press ▲/▼/◀/▶ to view a different part of the frame.

You may move the frame from the centre position to UP, DOWN, LEFT or RIGHT direction.

3 In the zoom mode press ZOOM repeatedly to return to a 1:1 view (Q Off).

ZOOM

- Notes:**
- You can select the Pause, Slow or Search playback in the zoom mode.
 - Some discs may not respond to zoom feature.

Locating desired scene

Use the title, chapter and time recorded on the disc to locate the desired point to play back. To check the title, chapter and time, press **DISPLAY**.

1 Press SEARCH during playback or stop mode.

SEARCH

3 Press Numbered buttons (0-9) to change the number.

- If you input a wrong number, press **CLEAR**.
- Refer to the package supplied with the disc to check the numbers.

2 Press ▲ or ▼ to select the "Time", "Title" or "Chapter".

4 Press ENTER. Playback starts.

- When you change the title, playback starts from Chapter 1 of the selected title.
- Some discs may not work in the above operation.

Note:
In case of the Video-CD playback with PBC, the SEARCH does not work. To turn off PBC, see page 28.

Marking desired scenes

The unit stores the points that you want to watch again up to 3 points. You can resume playback from each scene.

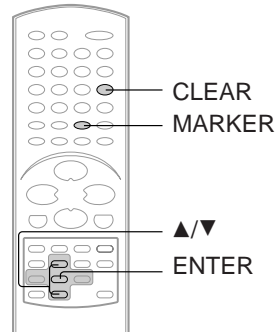

DVD VCD Marking the scenes

- 1 Press MARKER during playback.**

MARKER

Marker 1 : **: **: **
 Marker 2 : **: **: **
 Marker 3 : **: **: **
 ▲▼/Enter/Clear/Marker
- 2 Select the blank Marker using ▲ or ▼. Then press ENTER at the desired scene.**

 - Repeat this procedure to set the other 2 scenes.

Marker 1 : 00 : 27 : 54
 Marker 2 : **: **: **
 Marker 3 : **: **: **
 ▲▼/Enter/Clear/Marker
- 3 Press MARKER to remove this display.**

MARKER

DVD VCD Returning to the scenes

- 1 Press MARKER during playback or stop mode.**

MARKER

Marker 1 : 00 : 27 : 54
 Marker 2 : 01 : 16 : 25
 Marker 3 : 02 : 08 : 31
 ▲▼/Enter/Clear/Marker
- 2 Press ▲ or ▼ to select the Marker 1-3.**

Marker 1 : 00 : 27 : 54
 Marker 2 : 01 : 16 : 25
 Marker 3 : 02 : 08 : 31
 ▲▼/Enter/Clear/Marker
- 3 Press ENTER.**

Playback starts from the marked scene.

■ To cancel the Marker
Follow the above steps 1~2, then press **CLEAR**.

Notes:

- Some discs may not work with the marking operation.
- The marking is canceled when you open the disc tray or turn the power off.
- Some subtitles recorded around the marker may fail to appear.



Repeat playback/A-B Repeat playback

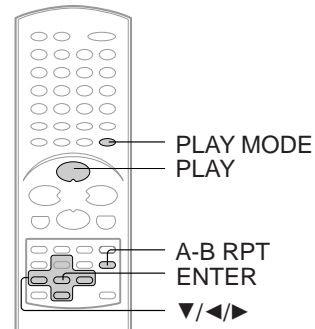

DVD VCD CD Repeat playback

1 Press **PLAY MODE** during playback or stop mode.

PLAY MODE



2 **DVD**
Press **◀▶** or **ENTER** once or twice to select "Chapter" or "Title".

The unit automatically starts repeat playback after finishing the current title or chapter.

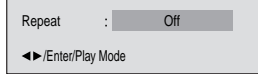
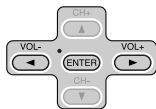

Audio CD, Video CD, MP3/WMA CD

Press **▼** to select "Repeat".

Press **◀▶** or **ENTER** once or twice to select "Track" or "All".

The unit automatically starts repeat playback after finishing the current track.

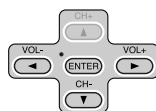

- If you set the repeat mode during stop mode, press **PLAY** to start Repeat playback.

3 Press **PLAY MODE** again to make the screen disappear.

■ To resume normal playback

Select Repeat : "Off" in step 2.

Notes:

- Some discs may not work with the repeat operation.
- In case of Video CD with PBC, repeat functions are prohibited during playback.

DVD VCD CD A-B Repeat playback

A-B repeat playback allows you to repeat material between two selected points.

1 Press **A-B RPT** during playback.

A-B RPT



The start point is selected.

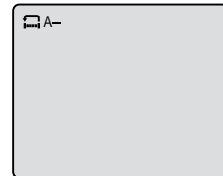

2 Press **A-B RPT** again.

A-B RPT



The end point is selected. Playback starts at the point that you selected. Playback stops at the end point, returns to Point A automatically, then starts again.

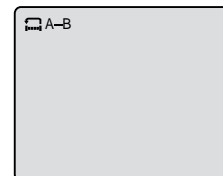

■ To resume normal playback

Press **A-B RPT** again.

A-B RPT



" Off" appears on the screen.

Notes:

- In A-B Repeat mode, subtitles near the A or B locations may not be displayed.
- You can not set the A-B Repeat for the scenes that include multiple angles.
- A-B Repeat playback does not work when Repeat playback is activated.
- You may not be able to set A-B Repeat, during certain scenes of the DVD.
- A-B Repeat does not work with an interactive DVD, MP3/WMA/JPEG CD.
- A-B Repeat is prohibited when PBC is on.

Program playback/Random playback

You can arrange the playback order of tracks or files on the disc. And also the unit selects tracks or files at random and playback them. These feature works for Audio CD, Video CD and MP3/WMA/JPEG CD.

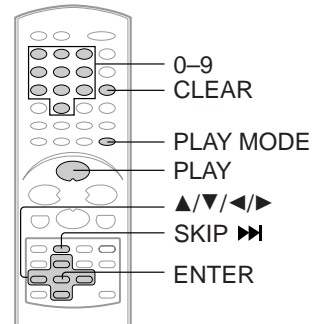

VCD CD Program playback

1 Press **PLAY MODE** during stop mode.

PLAY MODE



Play Mode	: Off
Repeat	: Off
◀▶▲▼/Enter/Play Mode	

2 Press **▲/▼** to select Play Mode, then press **◀/▶** or to select "Program".

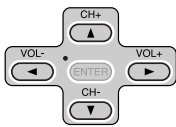

Play Mode	: Program						
Repeat	: Off						
1	---	4	---	7	---	10	---
2	---	5	---	8	---	11	---
3	---	6	---	9	---	12	---
Clear		Program Playback					
◀▶▲▼/Enter/0-9/Clear/Play Mode							

3 Press **▲/▼** or **◀/▶** to select the programming position. Use Numbered buttons (0-9) to input the track or file numbers.

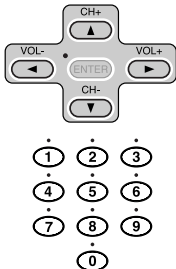

- To program others, repeat step 3.
- If you input a wrong number, press **CLEAR**.

Play Mode	: Program						
Repeat	: Off						
1	9--	4	---	7	---	10	---
2	3--	5	---	8	---	11	---
3	11-	6	---	9	---	12	---
Clear		Program Playback					
◀▶▲▼/Enter/0-9/Clear/Play Mode							

4 Press **▲/▼/◀/▶** to select "Program Playback" and press **ENTER**.

The programs you selected will start to playback in the order.

- In case of JPEG file, press **SKIP ▶▶** to continue the program playback.
- To resume normal playback, select Play Mode: "Off" in step 2.

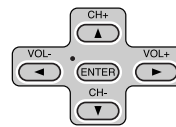

Play Mode	: Program						
Repeat	: Off						
1	7--	4	---	7	---	10	---
2	3--	5	---	8	---	11	---
3	11-	6	---	9	---	12	---
Clear		Program Playback					
◀▶▲▼/Enter/0-9/Clear/Play Mode							

■ **To change the program**

1. In the program mode, press **▲/▼/◀/▶** to select the track number.
2. Press **number buttons (0-9)** to select the track number to be replaced.

■ **To clear the program one by one**

In the program mode, press **▲/▼/◀/▶** to select the track number. Then press **CLEAR**.

■ **To clear all the programs**

In the program mode, press **▲/▼/◀/▶** to select "Clear". Then press **ENTER**.

Notes:

- In playing back the Video CD with PBC, you can not set Program playback.
- The program is cancelled when you open the disc tray or turn the power off.

VCD CD Random Playback

1 Press **PLAY MODE** during playback or stop mode.

PLAY MODE



2 Press **▲/▼** to select Play Mode, then press **◀/▶** or **ENTER** to select "Random".

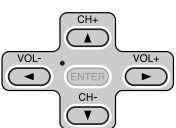

Play Mode	: Random
Repeat	: Off
◀▶▲▼/Enter/Play Mode	

3 Press **PLAY**.



The Random Playback will start.

- If you set "Random" during playback mode, Random playback will begin after the track that is currently being played has ended.
- To resume normal playback, select Play Mode: "Off" in step 2.

Note:

In playing back the Video CD with PBC, you can not set Random playback.



Changing angles/Title selection/DVD menu

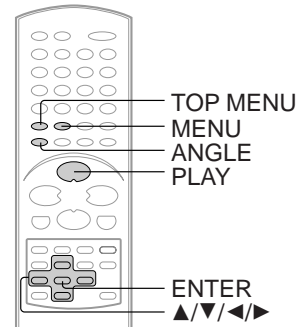

DVD Changing angles

When playing back a disc recorded with multi-angle facility, you can change the angle that you are viewing the scene from.

1 Press ANGLE during playback.
The current angle will appear.

ANGLE 

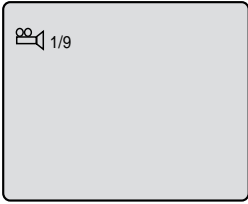

2 Press ANGLE repeatedly until the desired angle is selected.

ANGLE 

Note:
Depending on the DVD, you may not be able to change the angles even if multi-angles are recorded on the DVD.

DVD Title selection

Two or more titles are recorded on some discs. If the title menu is recorded on the disc, you can select the desired title.



1 Press TOP MENU during playback.
TOP MENU Title menu appears on the screen.

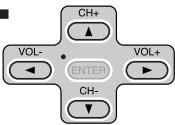

2 Press ▲/▼/◀/▶ to select the desired title.

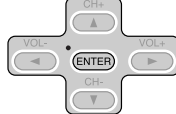

3 Press ENTER or PLAY.
The playback of the selected title will start.





Note:
Depending on the DVD, you may not be able to select the title. Depending on the DVD, a "title menu" may simply be called a "menu" or "title" in the instructions supplied with the disc.

DVD DVD menu

Some DVDs allow you to select the disc contents using the menu. When you play back these DVDs, you can select the subtitle language and sound-track language, etc. using the menu.

1 Press MENU during playback.
MENU The DVD menu appears on the screen.



- Press **MENU** again to resume playback at the scene when you pressed **MENU**.

2 Press ▲/▼/◀/▶ to select the desired item.



3 Press ENTER.
The menu continues to another screen. Repeat steps 2 and 3 to set the item completely.

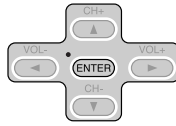

Note:
Depending on the DVD, you may not be able to resume playback from the scene point when you pressed the MENU button.



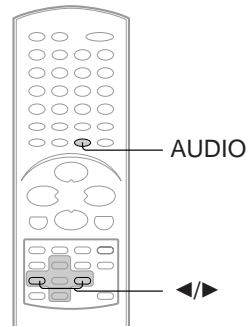

Changing soundtrack language/ Setting surround sound



DVD VCD Changing soundtrack language

You can select the language when you play a multilingual disc.

1 Press AUDIO during playback.
 AUDIO The current soundtrack language will appear.

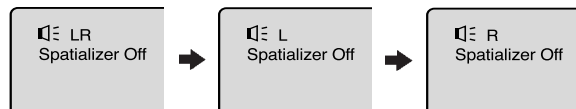

In case of Video CD playback

Audio type changes as follows each time you press **AUDIO**.



Notes:

- If the desired language is not heard after pressing the button several times, the language is not recorded on the disc.
- Changing soundtrack language is cancelled when you open the disc tray. The initial default language or available language will be heard if the disc is played back again.

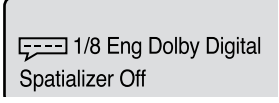
2 Press AUDIO repeatedly until the desired language is selected.
 AUDIO

 • The on screen display will disappear after a few seconds.

DVD VCD CD Setting surround sound

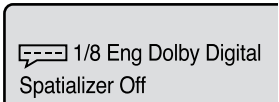
This DVD video player equipped with a "SPATIALIZER VIRTUAL SURROUND". It can produce the effect of being in a cinema or a concert hall.

1 During disc playback press AUDIO.
 AUDIO



To cancel Surround mode:

Follow the left steps 1~2, then press ◀ or ▶ to select the "Off" position.

Note:

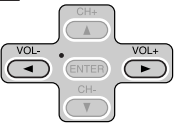
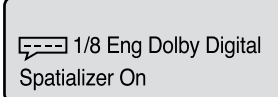
The "SPATIALIZER VIRTUAL SURROUND" is effective only for the sound of disc.

2 Press ◀ or ▶ to select "On".

 • The on screen display will disappear after a few seconds.

Spatializer® 3-Dimensional Sound Processing provided by Desper Products, Inc.

Certain audio features of this product manufactured under a license from Desper Products, Inc., Spatializer® and the circle-in-square device are trademarks owned by Desper Products, Inc.

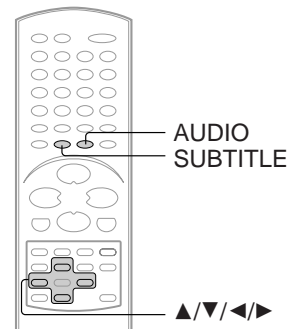

Subtitles/Karaoke playback



Subtitles

When playing back a disc recorded with subtitles, you can select the subtitle language or turn the subtitle off.

- 1 Press **SUBTITLE** repeatedly during playback until your desired language appears.

SUBTITLE



1/8 Eng

- 2 To turn off the subtitle, press **SUBTITLE** until "Off" appears.

SUBTITLE



Off

- The on screen display will disappear after a few seconds.

Notes:

- Depending on the DVD, you may not be able to change subtitles, or to turn subtitles on or off.
- While playing a DVD, the subtitle may change when you open or close the disc tray.
- In some cases, a selected subtitle language may not be changed immediately.

DVD Karaoke playback

You can turn the vocal on or off recorded on the DVD KARAOKE.

- 1 During DVD KARAOKE disc playback, press **AUDIO**.



1/8 Eng Dolby Digital
Spatializer Off

- 2 Press **▲** or **▼** until the **KARAOKE** symbol (🎤) appears.

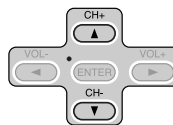

1/8 Eng Dolby Digital
Off

- If you play non-Karaoke disc, the KARAOKE symbol (🎤) does not appear.

- 3 Press **◀** or **▶** to select "On" or "Off".

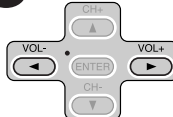

On : The primary vocal is output when it is recorded on the disc.
Off : The primary vocal is not output.

- The on screen display will disappear after a few seconds.

Notes:

- The vocal output feature is used during playback of Dolby Digital (multi-channel) recorded DVD KARAOKE discs. This feature allows you to turn off vocal audio tracks, or restore them for background accompaniment.
- When playing Karaoke, connect appropriate audio equipment such as an amplifier to the DVD video player.

Disc status/To turn off the PBC

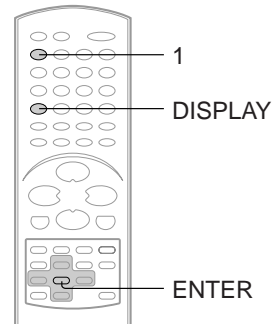

Disc status

With each press of **DISPLAY**, the status of the disc will appear on the screen and change as follows.

- **DISPLAY**



DVD

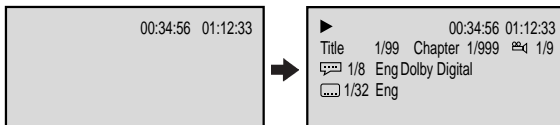

To make status display disappear, press **DISPLAY** again.

Video CD

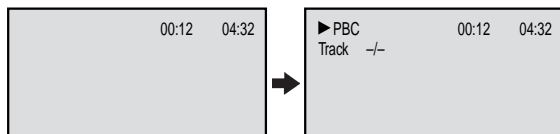

To make status display disappear, press **DISPLAY** again.

Audio CD

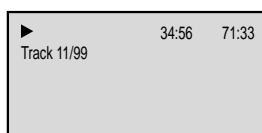

When you playback the CD disc, the status display will appear on the screen and continue displaying.

To turn off the PBC

Press number button **1** in the stop mode, then press **ENTER**.

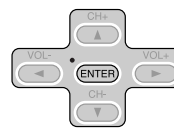



MP3/WMA/JPEG operation

This player can play back the MP3/WMA/JPEG-data which has been recorded on CD-R or CD-RW. To produce the MP3/WMA/JPEG-data, you need a Windows-PC with CD-ROM drive and a MP3/WMA/JPEG-encoding Software (not supplied).
The Apple-HFS-System can not be played.

MP3/WMA/JPEG CD information

Limitations on MP3/WMA/JPEG CD playback

- MP3/WMA/JPEG CD is the disc that is standardized by ISO9660, its file name must include 3-digits extension letters, "mp3", "wma", "jpg".
- MP3/WMA/JPEG CD must be correspond to the ISO standardized files.
- This unit can read 200 files per disc. If one directory has more than 200 files, it reads up to 200 files, the remaining files will be omitted.
- The unit is able to recognize up to a maximum of 50 directories per disc.
- MP3/WMA/JPEG CDs cannot be used for the purpose of recording.
- If the CD has both audio tracks and MP3/WMA/JPEG files, only audio tracks are played.
- It may take more than one minute for this unit to read MP3/WMA/JPEG files depending on its structure.
- Music recorded by "Joliet Recording Specification" can be played back, the file name is displayed (within 16 letters) on the screen. Long file names will be condensed.
- The music files recorded by "Hierarchical File System" (HFS) cannot be played.

Limitations on display

- The maximum number for display is 16 letters.
Available letters for display are the following:
capital or small alphabets of A through Z, numbers of 0 through 9, and _ (under score).
- Other letters than those above are replaced in hyphen.

Notes on MP3/WMA/JPEG files

To play back MP3/WMA/JPEG CD in the recorded order,

1. Use MP3/WMA/JPEG software that records data alphabetically or numerically.
2. Name each file including two-digit or three-digit number (ex. "01" "02" or "001" "002").
3. Refrain from making too many sub-folders.

CAUTION:

- Some MP3/WMA/JPEG CDs can not be played back depending on the recording conditions.
- The CD-R/RW that has no music data or non MP3/WMA/JPEG files can not be played back.

Standard, sampling frequency, and the bit rate:

MP3 CD

MPEG-1 Audio

32kHz, 44.1kHz, 48kHz

32kbps ~ 320kbps (constant bit rate or variable bit rate)

The recommend recording setting for a high-quality sound is 44.1kHz of sampling frequency and 128kbps of constant bit rate.

WMA CD

WMA version 7, and 8

32kHz, 48kbps

44.1kHz, 48kbps ~ 192kbps

48kHz, 128kbps ~ 192kbps

The file recorded by mono, 48kHz, 48 kbps is not available to this unit.

MP3/WMA/JPEG operation (continued)

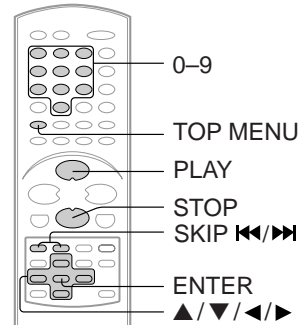

MP3/WMA CD playback

1 Place a disc on which MP3 or WMA files have been recorded onto the disc tray.

2 A file menu screen will appear on the screen. Press **◀▶** or **ENTER** to select folder.

3 Press **▲▼◀▶** or number buttons (0-9) to select the desired file.

- In case the folder includes more than 15 files, press **◀** or **▶** to display next file list.

- When **PLAY** has been pressed after displaying the file menu, or when the disc tray has been closed using **PLAY**, playback begins automatically starting from the first file. In this case, if the first file is an MP3/WMA file, only MP3/WMA files are played back in order. If the first file is a JPEG file, the first JPEG file is played back.

4 Press **ENTER**. The selected file starts playing back.

5 Press **STOP** to end playback.

- The unit records the stopped point. "■" appears on the screen. Press **PLAY** to resume playback (from the scene point).
- If you press **STOP** again or unload the disc, the unit will clear the stopped point.

About file menu

Media type	File number	Operation	Elapsed time
Folder	CD-R	▶	1/94 02:36
Folder	■ Pops		
MP3	1 Japan	8 flower	
MP3	2 Bay Bridge	9 Lies and Truth-	
MP3	3 CLOSE MY EYES	10 winter fall	
MP3	4 DIVE TO BLUE	11 Rain	
MP3	5 Honey	12 Strawberry	
MP3	6 BLUE EYES	13 Welcome party	
MP3	7 Blurry Eyes	14 Thailand	
WMA	15 Mother		
WMA	16 Hold Your Last		

- : Indicates MP3-file
- : Indicates WMA-file
- : Indicates JPEG-file

Notes:

- The picture menu is displayed when the FUJICOLOR CD or the Kodak Picture CD are played. To display the file menu press **TOP MENU**.
- In the case of a CD containing a mixture of MP3, WMA and JPEG files, the files are played back by selecting them from the file menu.
- MP3 or WMA file on the Kodak Picture CD is not recognized on this unit.

Notes:

- During MP3/WMA/JPEG-Playback, you can not use SEARCH, A-B Repeat functions.
- You can use Repeat (Track or All), Random functions and Program playback for MP3/WMA/JPEG CD Playback (see pages 23 and 24).
- In the case of a CD containing a mixture of MP3, WMA and JPEG files, the files are played back by selecting them from the file menu.

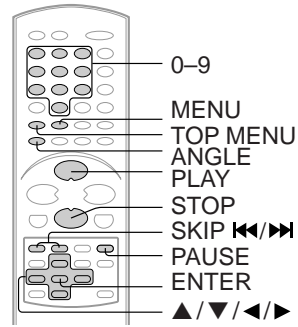

JPEG CD playback

1 Place a disc on which JPEG files have been recorded onto the tray.

2 A file menu screen will appear on the screen. Press **◀▶** to select folder.

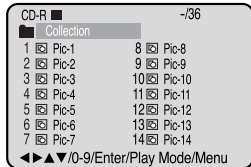
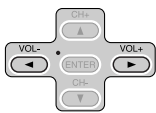

3 Press **▲/▼/◀▶** or number buttons (0-9) to select the desired file.

To display a picture menu, press **MENU**.
(To return to a file menu, press **TOP MENU**.)
Press **◀▶** or **▲/▼** to select the desired file.

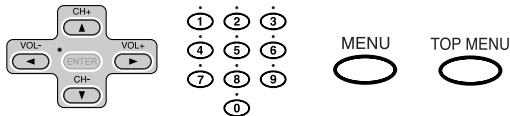

- To display next list, press **SKIP ◀▶▶**.
- When **PLAY** has been pressed after displaying the file menu, or when the disc tray has been closed after pressing **PLAY**, playback begins automatically starting from the first file. In this case, if the first file is a JPEG file, the first JPEG file is played back. If the first file is an MP3/WMA file, only MP3/WMA files are played back in order.

4 Press **ENTER**. The selected picture appears on the screen.

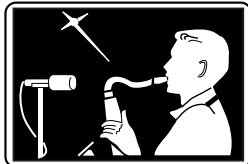
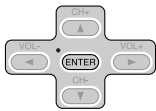

Rotating an image

You can rotate an image by 90 degrees by pressing **ANGLE** during playback of the image.
“”, “”, “” or “” appears briefly on the screen.

5 Press **STOP** to end playback.
The file menu appears on the screen.
If you want to watch the other file, repeat steps 3 ~ 4.



Slide show playback

The slide show enables you to view pictures (files) one after another automatically.

Preparation:

- Set “JPEG Interval” setting to “5 Seconds”, “10 Seconds” or “15 Seconds” (see page 36).

1 Select your desired starting file for the slide show in the step 3 as left.

2 Press **ENTER** to start slide show from the selected file.

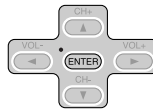

- If you press **PAUSE** during the slide show, the slide show stops temporary. “” appears briefly on the picture.
If the picture appears upside down or sideways, press **ANGLE** repeatedly until it's right side up.
“”, “”, “” or “” appears briefly on the screen.
Press **PLAY** or **SKIP ▶▶** again to resume the slide show.
- When the slide show playback finished the file list appears.
- To stop the slide show, press **STOP**. The file list appears.

Selecting *PROGRESSIVE* scan

The progressive scan capability provides the highest resolution pictures with less flicker and line structure.

If you are using the Component video jacks, but are connecting the DVD video player to a standard (analog) television, set PROGRESSIVE to Off.

If you are using the Component video jacks for connection to a TV or monitor that is compatible with a progressive scan signal, set PROGRESSIVE to On.

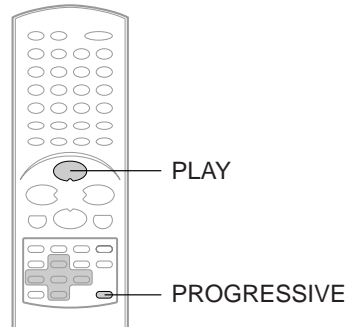

Selecting PROGRESSIVE scan

Preparation:

- Connect to a TV equipped with component jacks.
- Turn ON the TV and set it to the corresponding video input mode.
- Set the COMPONENT/S-VIDEO selector switch on the rear panel to COMPONENT position.

1 Press PROGRESSIVE during stop mode.



“P On” will appear on the screen for approx. 4 seconds.

- The unit recognizes the picture source (film or video) of the current disc according to the disc information.

2 Press PLAY to start playback.



There are two types of source content in pictures recorded in DVD video discs: film content (pictures recorded from films at 24 frames per second) and video content (video signals recorded at 30 frames per second).

When the unit plays back a film source material, uninterlaced progressive output signals are created using the original information. When a video content is played back, the unit interleaves lines between the interlaced lines on each to create the interpolated picture and outputs as the progressive signal.

■ To select PROGRESSIVE scan Off

Press PROGRESSIVE during stop mode.

“P Off” will appear on the screen for approx. 4 seconds.

Notes:

- Some discs may not be played back with the progressive scanning mode correctly because of the disc characteristics or recording condition.
- If your TV does not accept the progressive scan format, the picture will appear scrambled if you select progressive scan output from the unit. In such a case, select PROGRESSIVE scan Off.
- Once PROGRESSIVE scan on, all other video outputs are disabled except component video outputs.
- You cannot make the progressive scanning mode active in following cases.
 - The disc is played back.
 - The COMPONENT/S-VIDEO selector switch is set to S-VIDEO position.



Customizing the function settings

You can change the default settings to customize performance to your preference.

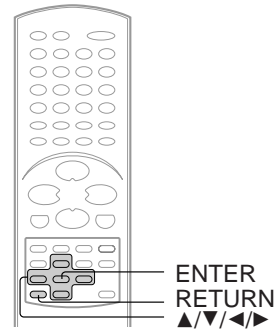

DVD VCD CD Setting procedure

1 Press **SETUP** during stop mode.

SET UP

The following on-screen display appears.

5 To make **SETUP** screen disappear, press **SETUP** or **RETURN**.

SET UP

RETURN

2 Press **◀** or **▶** to select the desired section, then press **▼** or **ENTER**.

3 Press **▲** or **▼** to select the desired option.

4 Change the selection using **▲/▼/◀/▶** or **ENTER**, by referring to the corresponding pages 35~37.

- Repeat step 3 and 4 to change other settings.
- To select another operation, go back to step 2.

Customizing the Function Settings (continued)

Setting details

Section	Option	Details	Page
Language	Menu Subtitle Audio	To select the language of "Menu", "Subtitle" and "Audio" if their languages are recorded onto the disc more than one language.	35
Picture	E.B.L.	To select On or Off for E.B.L. (Enhanced Black Level).	35
	Tv Screen	To select a picture size according to the aspect ratio of your TV.	35
	Display	To turn on or de-activate the operational status display on the screen.	36
	JPEG Interval	To select a preferred setting for the slide show playback.	36
	Select Files	To select a preferred file type for playing back a CD containing a mixture of file types.	36
Sound	Dialogue	To select On or Off for DRC (Dynamic Range Control).	36
Parental	Password	Input 4-digital password to set the parental level.	37
	Parental	To select a preferred parental level for the parental setting.	
Other	OSD language	To select a preferred language for on screen display.	37



Language

Language	Picture	Sound	Parental	Other
Menu		English		
Subtitle		Automatic		
Audio		English		

◀▶▲▼/Enter/Setup/Return

■ Menu, Subtitle, Audio

You can select the language of “Menu”, “Subtitle” and “Audio” if their languages are recorded onto the disc more than one language.

English, Francais, Espanol:

The selected language will be heard or seen.

Other:

Other language can be selected (see the “Language code list” on page 39).

Original: (Audio)

The unit will select the first priority language of each disc.

Automatic: (Subtitle)

- The unit will automatically select the same language in the AUDIO setting.
- When the unit selects the same language as the AUDIO, the subtitles will not appear during playback.
- When you do not use the same language as the AUDIO, the subtitles will appear during playback.

Off: (Subtitle)

Subtitles do not appear.

Note:

If the selected language is not recorded on the disc, the first-priority language is selected.

Picture

Language	Picture	Sound	Parental	Other
E.B.L.		Off		
Tv Screen	4:3	<input type="checkbox"/>		
Display		On		
JPEG Interval		Off		
Select Files		All		

◀▶▲▼/Enter/Setup/Return

■ E.B.L.

To select the black level of playback pictures, set your preference and monitor’s ability.

On: Enhanced grey scale (0 IRE cut off)

Off: Standard grey scale (7.5 IRE cut off)

■ Tv Screen

You have the following screen sizes to choose from:

4:3 Letter box:

Select this mode when connecting to a conventional TV. When playing back a wide screen-DVD disc, it displays the wide picture with black bands at the top and bottom of screen.

4:3 Pan scan:

It displays the wide picture on the whole screen with left and right edges automatically cut off.

16:9 Wide:

Select this mode when connecting to a wide-screen TV. A wide screen picture is displayed full size.

Note:

If the DVD disc is not formatted in the pan & scan style, it displays 4:3 style.



Customizing the Function Settings (continued)

Setting details

■ Display

On screen display can be switched on or off when you press the buttons.

On: On screen displays appear when you press the buttons (factory setting).

Off: On screen displays do not appear when you press any buttons.

■ JPEG Internal

You can continuously play back all JPEG files automatically.

After the setting below, start playing the disc on which JPEG files have been recorded.

Off:

Plays back one file at a time.

5 Seconds:

Plays back images in the form of a slide show at 5 second intervals.

10 Seconds:

Plays back images in the form of a slide show at 10 second intervals.

15 Seconds:

Plays back images in the form of a slide show in 15 second intervals.

■ Select Files

When playing back a CD containing a mixture of MP3, WMA and JPEG files, only MP3/WMA or JPEG files can be displayed on the file menu.

All:

Displays all files.

Music Only:

Displays only MP3/WMA files.

Pictures Only:

Displays only JPEG files.

Sound

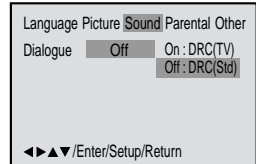

■ Dialogue

DRC (Dynamic Range Control) enables you to control the dynamic range so as to achieve a suitable sound for your equipment.

On: Loud sound such as explosion or the like is toned down slightly when played back. This makes it suitable for when it is connected to a stereo.

Off: It plays back at the recording level on the disc.

Notes:

- This function works only during playback of Dolby Digital recorded discs.
- The level of Dynamic Range Reduction may differ depending on DVD video disc.



Parental

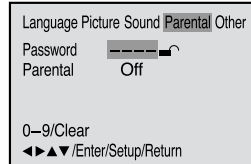

Parental control setting

Some discs are specified not suitable for children. Such discs can be limited not to play back with the unit.

- 1) Press **▲** or **▼** to select "Parental", then press **◀** or **▶** until the level you require appears.
 - Level Off: The parental control setting does not function.
 - Level 8: All DVD software can be played back.
 - Level 1: DVD software for adults cannot be played back.

Select from the level 1 to level 8. The limitation will be more severe as the level number is lower.

- 2) Press **▲** or **▼** to select "Password". Press **number buttons (0-9)** to input a 4-digit password. Be sure to remember this number!
 - If you input a wrong number, press **CLEAR**.
- 3) Press **ENTER** to store the password. Note: Now the rating is locked and the setting can not be changed unless you enter the correct password.

Notes:

- Depending on the discs, the unit cannot limit playback.
- Some discs may not be encoded with specific rating level information though its disc jacket says "adult." For those discs, the age restriction will not work.

To change the parental level

- 1) Press **▲** or **▼** to select "Password".
- 2) Press **number buttons (0-9)** to enter the password you have stored.
- 3) Press **ENTER**.
 - The rating is now unlocked.
- 4) Press **▲** or **▼** to select "Parental", then press **◀** or **▶** to change the parental level.
- 5) Press **▲** or **▼** to select "Password", then press **number buttons (0-9)** to enter the password. Note: You can change the password if you want.
- 6) Press **ENTER**. Now the parental level is changed and locked.

If you forget the password...

1. Press **OPEN/CLOSE** to open the disc tray.
2. Remove the disc.
3. Press **OPEN/CLOSE** again to close the disc tray. "No Disc" appears on the screen.
4. While holding **STOP** down on the front panel, press **7** on the remote control. "PASSWORD CLEAR" appears on the screen.
5. Enter a new password again.

Notes:

- Depending on the discs, the unit may not be able to limit playback.
- Some discs may not be encoded with specific rating level information though its disc jacket says "adult." For those discs, the parental control feature will not work.

Other

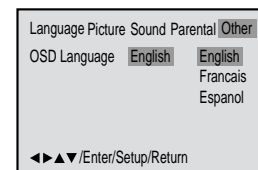

OSD Language

The setup language can be selected.

- English:** To display OSD language is English.
- Francais:** To display OSD language is Francais.
- Espanol:** To display OSD language is Espanol.

Note:

If each setup (pages 35-37) has been completed, the unit can always be worked under the same conditions (especially with DVD discs).

Each setup will be retained in the memory if you turn the power off.

Temporary disabling of rating level by DVD disc

Depending on the DVD disc, the disc may try to temporarily cancel the rating level that you have set. It is up to you to decide whether to cancel the rating level or not.

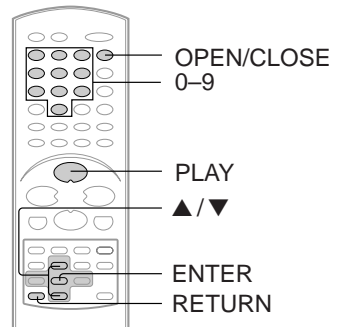

1 Load a DVD disc and press **PLAY** or **OPEN/CLOSE** on the unit (see page 18).

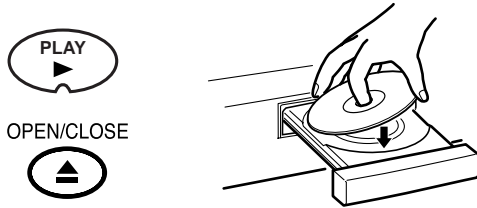

2 If the DVD disc has been designed to temporarily cancel the Rating level, the screen which follows the "Reading" screen will change, depending on which disc is played. If you select "YES" with the **ENTER** key, "Your disc exceeds the parental control level#." screen will then appear.

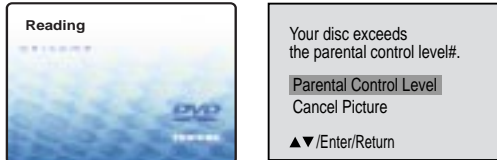

3 If you wish to cancel the set rating level temporarily, select "Parental Control Level" with **▲** or **▼**, then press **ENTER**. If the 4-digit password at step 2 on page 37 has been set, the password entering screen will appear as shown in step 4. Alternatively, if the password has not been set, playback will commence. If you don't know (or have forgotten) the password, select "Cancel Picture". The setting screen will disappear. Press **OPEN/CLOSE** to remove the disc.

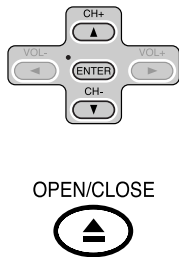

4 Enter the password with number buttons (0-9). Then press **ENTER**.

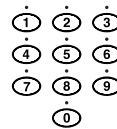

If you interrupt the entering, press **RETURN**.

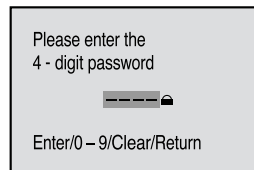
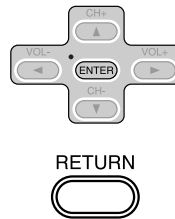

5 Playback will commence if the entered password was correct.

Note:

This temporary cancellation of rating level will be kept until the disc is ejected. When the disc is ejected, the original rating level will be set again automatically.

Language code list

Enter the appropriate code number for the initial settings "Menu", "Subtitle" and/or "Audio" (see pages 35).

Language Name	Code	Language Name	Code	Language Name	Code	Language Name	Code
Abkhazian	1112	Fiji	1620	Lingala	2224	Singhalese	2919
Afar	1111	Finnish	1619	Lithuanian	2230	Slovak	2921
Afrikaans	1116	French	1628	Macedonian	2321	Slovenian	2922
Albanian	2927	Frisian	1635	Malagasy	2317	Somali	2925
Amharic	1123	Galician	1722	Malay	2329	Spanish	1529
Arabic	1128	Georgian	2111	Malayalam	2322	Sundanese	2931
Armenian	1835	German	1415	Maltese	2330	Swahili	2933
Assamese	1129	Greek	1522	Maori	2319	Swedish	2932
Aymara	1135	Greenlandic	2122	Marathi	2328	Tagalog	3022
Azerbaijani	1136	Guarani	1724	Moldavian	2325	Tajik	3017
Bashkir	1211	Gujarati	1731	Mongolian	2324	Tamil	3011
Basque	1531	Hausa	1811	Nauru	2411	Tatar	3030
Bengali; Bangla	1224	Hebrew	1933	Nepali	2415	Telugu	3015
Bhutani	1436	Hindi	1819	Norwegian	2425	Thai	3018
Bihari	1218	Hungarian	1831	Oriya	2528	Tibetan	1225
Breton	1228	Icelandic	1929	Panjabi	2611	Tigrinya	3019
Bulgarian	1217	Indonesian	1924	Pashto, Pushto	2629	Tonga	3025
Burmese	2335	Interlingua	1911	Persian	1611	Turkish	3028
Byelorussian	1215	Irish	1711	Polish	2622	Turkmen	3021
Cambodian	2123	Italian	1930	Portuguese	2630	Twi	3033
Catalan	1311	Japanese	2011	Quechua	2731	Ukrainian	3121
Chinese	3618	Javanese	2033	Rhaeto-Romance	2823	Urdu	3128
Corsican	1325	Kannada	2124	Romanian	2825	Uzbek	3136
Croatian	1828	Kashmiri	2129	Russian	2831	Vietnamese	3219
Czech	1329	Kazakh	2121	Samoan	2923	Volapük	3225
Danish	1411	Kirghiz	2135	Sanskrit	2911	Welsh	1335
Dutch	2422	Korean	2125	Scots Gaelic	1714	Wolof	3325
English	1524	Kurdish	2131	Serbian	2928	Xhosa	3418
Esperanto	1525	Laothian	2225	Serbo-Croatian	2918	Yiddish	2019
Estonian	1530	Latin	2211	Shona	2924	Yoruba	3525
Faroese	1625	Latvian, Lettish	2232	Sindhi	2914	Zulu	3631

Multi brand remote control

The remote control can be compatible with various brands of TV by setting their control codes. The TOSHIBA code has initially been set to control TOSHIBA TVs.

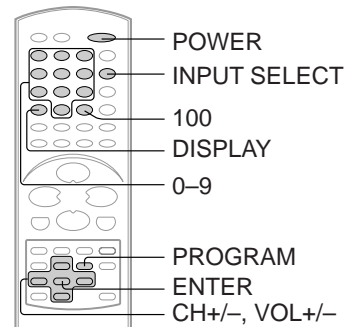

Setting TV control codes

1 Press TV to set the remote control operating your TV.



2 While holding down PROGRAM enter the two digits of your TV's brand code (listed below) using number buttons (0-9), then release PROGRAM.

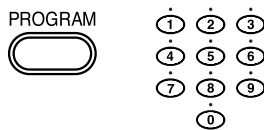

Point the remote control at your TV and use each button listed below to make sure that your TV is operated correctly.

- POWER To turn the TV on or off.
- CH +/- To select TV channels in the upper or lower direction.
- VOL +/- To adjust the sound level.
- INPUT SELECT To select an external source such as a VCR.
- Number buttons (0-9) To select TV channels. When selecting channels 1 to 9, first enter 0 and then desired number.
- 100 To substitute for 100 channel key.
- DISPLAY To turn on or off TV's screen display.
- ENTER To use for the TV's ENTER key.

Important

Some TV's may not respond to all the operations left, or may not be operated at all with this remote control. In this case, operate your TV with its own remote control.

Notes:

- For some brands, several control codes (brand codes) are allocated. Try each of them until the buttons work on your TV.
- If you replace the remote control's batteries, set the brand code again.

Table of TV brand codes

Brand No.	TV Brand	Brand No.	TV Brand	Brand No.	TV Brand
01	TOSHIBA	07	PANASONIC	13	SHARP (old)
02	RCA / GE	08	SHARP (New)	14	ZENITH
03	SONY	09	SANYO (FISHER)	15	PANASONIC
04	MITSUBISHI	10	MAGNAVOX	16	PIONEER
05	JVC	11	GOLDSTAR		
06	HITACHI	12	SAMSUNG		

Troubleshooting guide

Check the following guide for the possible cause of a problem before contacting service.

Symptom	Cause	Correction	Page
No power.	<ul style="list-style-type: none"> The power plug is disconnected. 	<ul style="list-style-type: none"> Connect the power plug securely into the wall outlet. 	14
No picture.	<ul style="list-style-type: none"> The TV is not set to receive DVD signal output. 	<ul style="list-style-type: none"> Select the appropriate video input mode on the TV so the picture from the DVD video player appears on the TV screen. 	—
	<ul style="list-style-type: none"> The video cable is not connected securely. 	<ul style="list-style-type: none"> Connect the video cable securely into the appropriate jacks. 	14, 15
No picture, or the screen is blurred or divided into two parts.	<ul style="list-style-type: none"> The COMPONENT/S-VIDEO selector is not set correctly. 	<ul style="list-style-type: none"> Set the COMPONENT/S-VIDEO selector to the appropriate position. 	14, 15
	<ul style="list-style-type: none"> The PROGRESSIVE scan is On through the unit is connected to a TV via the VIDEO out or the S-VIDEO out jack. 	<ul style="list-style-type: none"> Set the PROGRESSIVE scan Off. 	32
No sound.	<ul style="list-style-type: none"> The equipment connected with the audio cable is not set to receive DVD signal output. 	<ul style="list-style-type: none"> Select the correct input mode of the audio receiver so you can listen to the sound from the DVD video player. 	—
	<ul style="list-style-type: none"> The audio cable is not connected securely. 	<ul style="list-style-type: none"> Connect the audio cable securely into the appropriate jacks. 	14~17
	<ul style="list-style-type: none"> The audio receiver or TV is turned off. 	<ul style="list-style-type: none"> Turn on the equipment connected with the audio cable. 	—
	<ul style="list-style-type: none"> The unit is in the advanced playback mode. 	<ul style="list-style-type: none"> Resume the normal playback. 	21
The playback picture has occasional distortion.	<ul style="list-style-type: none"> The disc is dirty. 	<ul style="list-style-type: none"> Eject the disc and clean it. 	7
	<ul style="list-style-type: none"> It is in fast forward or fast reverse playback. 	<ul style="list-style-type: none"> Sometimes a small amount of picture distortion may appear. This is not a malfunction. 	—
Brightness is unstable or noises are present in the playback pictures.	<ul style="list-style-type: none"> The effect of copy protection. 	<ul style="list-style-type: none"> Connect the DVD video player directly to the TV. Avoid connecting the DVD video player to a VCR or TV/VCR combination. 	14
The DVD video player does not start playback.	<ul style="list-style-type: none"> No disc is inserted. 	<ul style="list-style-type: none"> Insert a disc. 	18
	<ul style="list-style-type: none"> An unplayable disc is inserted. 	<ul style="list-style-type: none"> Insert a playable disc. (Check the disc type and color system.) 	8
	<ul style="list-style-type: none"> The disc is placed upside down. 	<ul style="list-style-type: none"> Place the disc with the playback side down. 	18
	<ul style="list-style-type: none"> The disc is not placed within the guide. 	<ul style="list-style-type: none"> Place the disc correctly inside the guide on the disc tray. 	18
	<ul style="list-style-type: none"> The disc is dirty. 	<ul style="list-style-type: none"> Clean the disc. 	7
	<ul style="list-style-type: none"> The parental lock function is set. 	<ul style="list-style-type: none"> Cancel the parental lock function or change the parental lock level. 	37
	<ul style="list-style-type: none"> ⚡ appears on the screen. 	<ul style="list-style-type: none"> The function is prohibited with the unit or the disc. 	8
Playback does not follow the course of the disc's program.	<ul style="list-style-type: none"> It is in the mode of repeat playback, program playback, etc. 	<ul style="list-style-type: none"> These operations may prevent a proper progress of the contents. 	—
Buttons do not work.	<ul style="list-style-type: none"> Power supply fluctuations or other abnormalities such as static electricity may interrupt correct operations. 	<ul style="list-style-type: none"> Turn the power on or off with ON/STANDBY (I/O). Or disconnect the power plug and insert it into the wall outlet again. 	—
	<ul style="list-style-type: none"> The TV button is pressed. 	<ul style="list-style-type: none"> Press the DVD button to operate the DVD. 	18
The remote control does not work properly.	<ul style="list-style-type: none"> The remote control is not pointed at the remote sensor of the DVD video player. 	<ul style="list-style-type: none"> Point the remote control at the remote sensor of the DVD video player. 	13
	<ul style="list-style-type: none"> The remote control is too far from the DVD video player. 	<ul style="list-style-type: none"> Operate the remote control within about 7 m. 	13
	<ul style="list-style-type: none"> The batteries in the remote control are exhausted. 	<ul style="list-style-type: none"> Replace the batteries with new ones. 	13

Specifications

DVD Video Player

Power supply	120 V AC, 60 Hz
Power consumption	Operation : 10 W Standby : 3 W
Mass	4.4 lbs (2.0 kg)
External dimensions	Width : 16 - 15/16 inches (430mm) Height : 2 - 5/16 inches (59mm) Depth : 8 - 1/8 inches (206mm)
Signal system	Standard NTSC
Pickup	CD : Wavelength: 775 - 815 nm Maximum output power: 0.5 mW DVD : Wavelength: 650 - 666 nm Maximum output power: 2.0 mW
Frequency response	DVD : 4 Hz - 22 kHz CD : 4 Hz - 20 kHz
Harmonic distortion	0.008 %
Wow and flutter	Below measurable level
Operating conditions	Temperature: 5 °C to 40 °C, Operation status: Horizontal

Outputs

Video output	1.0 V (p-p), 75 Ω, negative sync., pin jack × 1
S video output	(Y) 1.0 V (p-p), 75 Ω, negative sync., Mini DIN 4-pin × 1 (C) 0.286 V (p-p), 75 Ω
Component video output	(Y) 1.0 V (p-p), 75 Ω, negative sync., pin jack × 1 (P _B)/(P _R) 0.7 V (p-p), 75 Ω, pin jack × 2
Audio output (BITSTREAM/PCM COAXIAL)	0.5V (p-p), 75 Ω, pin jack × 1
Audio output (BITSTREAM/PCM OPTICAL)	Optical connector × 1
Audio output (ANALOG)	-12 dBm, 1k Ω, pin jacks (L, R) × 1
COMPONENT/S-VIDEO selector	Slide switch × 1

Supplied Accessories

Audio/video cable	1
Remote control (SE-R012)	1
Batteries (AAA)	2

- Designs and specifications are subject to change without notice.



LIMITED WARRANTY DVD VIDEO PLAYER

Toshiba America Consumer Products, L.L.C. ("TACP") and Toshiba Hawaii, Inc. ("THI") make the following limited warranties to original consumers for DVD Players purchased and used in the United States. THESE LIMITED WARRANTIES EXTEND TO THE ORIGINAL CONSUMER PURCHASER OR ANY PERSON RECEIVING THIS DVD PLAYER AS A GIFT FROM THE ORIGINAL CONSUMER PURCHASER AND TO NO OTHER PURCHASER OR TRANSFEREE.

PRODUCTS PURCHASED IN THE U.S.A. AND USED IN CANADA ARE NOT COVERED BY THESE WARRANTIES.

PRODUCTS PURCHASED IN CANADA AND USED IN THE U.S.A. ARE NOT COVERED BY THESE WARRANTIES.

Limited One (1) Year Warranty*

TACP/THI warrants this DVD Player against defects in materials or workmanship for a period of one (1) year after the date of the original retail purchase. DURING THIS PERIOD TACP/THI WILL, AT TACP/THI'S OPTION, REPAIR OR EXCHANGE A DEFECTIVE DVD PLAYER WITH A NEW OR REFURBISHED DVD PLAYER, AT TACP/THI'S OPTION. DURING THE INITIAL NINETY (90) DAYS, THIS REPAIR OR EXCHANGE WILL BE WITHOUT CHARGE TO YOU, EXCEPT YOU MUST PAY FOR ALL TRANSPORTATION AND INSURANCE CHARGES FOR THE DVD PLAYER TO BE SHIPPED TO THE DESIGNATED TACP/THI FACILITY. AFTER THE INITIAL NINETY (90) DAYS AND FOR THE REMAINDER OF THE WARRANTY PERIOD, AN ADDITIONAL HANDLING FEE WILL APPLY. YOU MUST DELIVER THE ENTIRE DVD PLAYER AND ALL ACCESSORIES (SUCH AS POWER CORDS, CABLES, AND THE UNIT'S REMOTE CONTROL DEVICE) TO THE DESIGNATED TACP/THI FACILITY, AS INSTRUCTED BY TACP/THI. TACP/THI IS NOT RESPONSIBLE IF YOUR DVD PLAYER IS LOST OR DAMAGED DURING SHIPMENT.

*Commercial Units

DVD Players sold and used for commercial purposes have a limited ninety (90) day warranty.

Rental Units

The warranty period for rental units begins with the first rental or thirty (30) days from the date of shipment to the rental firm, whichever comes first.

Owner's Manual and Demographic Card

You should read this owner's manual thoroughly before operating this DVD Player. You should complete and mail the enclosed Demographic Card within ten days after you, or the person who has given you this product as a gift, purchased this DVD Player. This is one way to enable TACP/THI to provide you with better customer service and improved products. Failure to return the Demographic Card will not affect your rights under this warranty.

Your Responsibility

THE ABOVE LIMITED WARRANTIES ARE SUBJECT TO THE FOLLOWING CONDITIONS:

- (1) You must provide your bill of sale or other proof of purchase. For rental firms, proof of first rental is also required.
- (2) The limited warranties from TACP and THI are effective only if the DVD Player is purchased and operated in the U.S.A. or Puerto Rico.
- (3) Labor service charges for installation, set up, and adjustment of customer controls are not covered by these limited warranties.
- (4) These limited warranties extend only to defects in materials or workmanship as limited above and do not extend to any DVD Player or accessories which have been lost or discarded by you, or to damage to any DVD Player or accessories caused by misuse, accident, Acts of God (such as lightning), or to fluctuations in electric power, improper installation, improper maintenance or use in violation of instructions furnished by TACP/THI; or to units which have been modified or which have had the serial number removed, altered, defaced or rendered illegible.
- (5) Physically damaged DVD Players are not acceptable for repair or exchange whether in or out of warranty and will be returned as received.

How to Obtain Warranty Services

If, after following all of the operating instructions in this manual and checking the "Troubleshooting" section, you find that service is needed, call one of the following Customer Solutions Centers to obtain further instructions. Have your proof of purchase and your model and serial numbers available when you call.

For DVD Players purchased in the United States, except Hawaii, call TACP, toll free at **1-866-583-7353**.

For DVD Players purchased in Hawaii, call THI. at **808-591-9281**.

For additional updates, visit TACP's web site: www.toshiba.com/tacp.



LIMITATION OF IMPLIED WARRANTIES

ALL WARRANTIES IMPLIED BY THE LAW OF ANY STATE OF THE U.S.A., INCLUDING THE IMPLIED WARRANTIES OF MERCHANTABILITY AND FITNESS FOR A PARTICULAR PURPOSE, ARE EXPRESSLY LIMITED TO THE DURATION OF THE LIMITED WARRANTIES SET FORTH ABOVE.

LIMITATION OF WARRANTY

WITH THE EXCEPTION OF ANY WARRANTIES IMPLIED BY THE LAW OF ANY STATE OF THE U.S.A. AS HEREBY LIMITED, THE FOREGOING LIMITED WARRANTY IS EXCLUSIVE AND IN LIEU OF ALL OTHER WARRANTIES, GUARANTEES, AGREEMENTS AND SIMILAR OBLIGATIONS OF TACP OR THI WITH RESPECT TO YOUR DVD PLAYER.

EXCLUSION OF DAMAGES

IN NO EVENT SHALL TACP OR THI BE LIABLE FOR CONSEQUENTIAL OR INCIDENTAL DAMAGES.

No Change, Modification, or Extension

No person, agent, distributor, dealer or company is authorized to change, modify or extend the terms of these limited warranties in any manner whatsoever.

Time for Taking Action

The time within which action must be commenced to enforce any obligation of TACP or THI arising under this limited warranty or under any law of the United States or of any state thereof is hereby limited to 90 days from the date you discovered, or should have discovered, the defect. This limitation does not apply to implied warranties arising under the law of any state of the U.S.A.

HOW STATE LAW RELATES TO WARRANTY

THIS WARRANTY GIVES YOU SPECIFIC LEGAL RIGHTS, AND YOU MAY ALSO HAVE OTHER RIGHTS WHICH MAY VARY FROM STATE TO STATE IN THE U.S.A.

SOME STATES OF THE U.S.A. DO NOT ALLOW LIMITATIONS ON HOW LONG AN IMPLIED WARRANTY LASTS, WHEN AN ACTION MAY BE BROUGHT, OR THE EXCLUSION OR LIMITATION OF INCIDENTAL OR CONSEQUENTIAL DAMAGES, SO THE ABOVE LIMITATIONS OR EXCLUSIONS MAY NOT APPLY TO YOU UNDER SUCH CIRCUMSTANCES.

IMPORTANT: PACKING AND SHIPPING INSTRUCTION

When you send the product to a Service Station, you must use the original carton box and packing material, then insert the original carton box containing the unit into another carton using more packing material.

TOSHIBA

TOSHIBA AMERICA CONSUMER PRODUCTS, L.L.C.



04/01 U

J2C01501A

Printed in Thailand



REPRODUCTOR DE DVD SD-K740SU

Referencia rápida



PRECAUCIONES DE SEGURIDAD

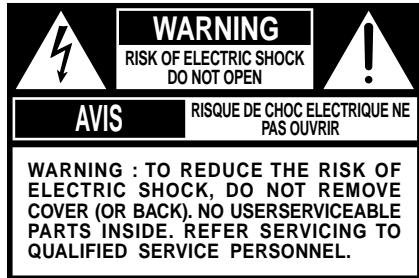

El símbolo de rayo con cabeza de flecha, dentro de un triángulo equilátero, tiene como fin indicar al usuario la presencia de "tensión peligrosa" no aislada dentro de la caja del producto, que puede ser de magnitud suficiente como para constituir un riesgo de electrocución de personas.



El signo de exclamación dentro de un triángulo equilátero tiene como fin indicar al usuario la presencia de instrucciones importantes de operación y mantenimiento (reparación) en la literatura que acompaña al producto.

ADVERTENCIA: PARA REDUCIR EL RIESGO DE INCENDIOS O DE ELECTROCUCIÓN, NO EXPONGA ESTE PRODUCTO A LA LLUVIA NI A LA HUMEDAD. EN EL INTERIOR DE LA CAJA EXISTEN ALTAS TENSIONES PELIGROSAS. NO ABRA LA CAJA. EN CASO DE AVERÍA SOLICITE LOS SERVICIOS DE PERSONAL CUALIFICADO SOLAMENTE.

PRECAUCIÓN: PARA EVITAR DESCARGAS ELÉCTRICAS, HAGA COINCIDIR LA CUCHILLA ANCHA DEL ENCHUFE CON LA RANURA ANCHA DEL TOMACORRIENTE, E INSÉRTELO COMPLETAMENTE.

PRECAUCIÓN: Este reproductor de videodiscos digitales utiliza un sistema de láser. Para asegurar la utilización adecuada de este producto, lea cuidadosamente este manual de instrucciones y consérvelo para futuras referencias. Cuando la unidad requiera mantenimiento, póngase en contacto con un centro de reparaciones autorizado - consulte el procedimiento de servicio.

La utilización de controles, o la realización de ajustes o procedimientos diferentes a los especificados puede resultar en exposición peligrosa a la radiación.

Para evitar la exposición directa al láser, no intente abrir la caja.

Si abre la caja y anula el interbloqueo, quedará expuesto a radiación láser visible e invisible. NO MIRE EL HAZ.

AVISO DE LA FCC: Este equipo ha sido probado y se ha encontrado que cumple con los límites para dispositivos digitales de Clase B, de acuerdo con la parte 15 de las normas de la FCC. Estos límites han sido diseñados para proporcionar una protección razonable contra interferencias perjudiciales en una instalación residencial. Este equipo genera, utiliza, y puede radiar energía de radiofrecuencia y, si no se instala y utiliza de acuerdo con las instrucciones, puede causar interferencias perjudiciales en las radiocomunicaciones. Sin embargo, no existe ninguna garantía de que tales interferencias no se produzcan en una instalación particular. Si este equipo causa interferencias perjudiciales, lo que podrá determinarse desconectando y volviendo a conectar su alimentación, se ruega que el usuario corrija las interferencias tomando una o más de las medidas siguientes:

- Reorientación o reubicación de la antena receptora.
- Aumento de la separación entre el equipo y el receptor.
- Conexión del equipo a un tomacorriente diferente del utilizado por el receptor.
- Solicitud de ayuda al proveedor o a un técnico de radio/televisión experimentado.

ADVERTENCIA: Los cambios o modificaciones realizados en este equipo, no aprobados expresamente por Toshiba, o los concesionarios autorizados por Toshiba, pueden anular la autoridad para utilizar el equipo.





INSTRUCCIONES IMPORTANTES SOBRE SEGURIDAD

PRECAUCIÓN: LEA Y OBSERVE CUIDADOSAMENTE TODAS LAS ADVERTENCIAS E INSTRUCCIONES OFRECIDAS EN ESTE MANUAL DE INSTRUCCIONES, Y LAS MARCADAS EN LA UNIDAD. GUARDE ESTE MANUAL PARA FUTURAS REFERENCIAS.

Este aparato ha sido diseñado y fabricado para asegurar la seguridad personal. La utilización inadecuada podría resultar en descargas eléctricas o en incendios. Las normas de seguridad incorporadas en esta unidad le protegerán si observa los procedimientos siguientes para la instalación, la utilización, y el mantenimiento.

Esta unidad está completamente transistorizada, y no contiene piezas que pueda reparar el usuario.

NO quite la cubierta de la caja, porque podría quedar expuesto a tensiones peligrosas. EN CASO DE AVERÍA, solicite los servicios de personal de reparación cualificado solamente.

1. Lea estas instrucciones.
2. Guarde estas instrucciones.
3. Tenga en cuenta todas las advertencias.
4. Siga todas las instrucciones.
5. No utilice este aparato cerca del agua.
6. Limpiar únicamente con paños secos.
7. No bloquee ninguna de las aberturas de ventilación del aparato. Instálelo de acuerdo con las instrucciones del fabricante.
8. El aparato deberá colocarse alejado de fuentes térmicas, tales como radiadores, salidas de aire cálido, estufas, y demás aparatos (incluyendo amplificadores) que produzcan calor.
9. No anule la finalidad de seguridad del enchufe polarizado o de tipo de puesta a tierra. Un enchufe polarizado tiene dos cuchillas, una cuchilla más ancha que la otra. Un enchufe de tipo de puesta a tierra tiene dos cuchillas y una tercera espiga de puesta a tierra. La cuchilla ancha o la tercera espiga han sido previstas para su seguridad. Si el enchufe proporcionado no se puede insertar completamente en el tomacorriente, póngase en contacto con un electricista para que reemplace su tomacorriente obsoleto.
10. Proteja el cable de alimentación para que no sea pisado o estrujado particularmente en la parte de los tomacorrientes, de los prolongadores de enchufes y en el punto en el que sale del aparato.
11. Utilice solamente las fijaciones/accesorios especificados por el fabricante.
12. Utilice solamente el carrito, estante, trípode, soporte, o mesa recomendado por el fabricante, o vendido con el aparato. Cuando utilice un carrito, tenga cuidado al mover la combinación de aparato y carrito para no volcarlo evitando así daños serios.
13. Desenchufe este aparato durante las tormentas eléctricas o cuando no lo vaya a utilizar durante mucho tiempo.
14. Solicite los servicios de personal de reparación cualificado. Requiera servicio de reparación de cualquier manera que el aparato haya sido dañado, por ejemplo, cuando el cable o el enchufe de alimentación se haya dañado, si se ha vertido líquido sobre el aparato, o si en el interior del mismo han caído objetos, si el aparato ha estado expuesto a la lluvia o al agua, si el aparato no funciona normalmente o si el aparato se ha caído.
15. Cuando utilice auriculares, mantenga el volumen a un nivel moderado. Si utilizase auriculares continuamente a gran volumen, podría dañar sus oídos.
16. No sobrecargue los tomacorrientes, cables prolongadores, ni prolongadores de tomacorrientes, ya que esto podría resultar en el riesgo de incendios o descargas eléctricas.
17. No introduzca nunca ningún tipo de objeto en este aparato a través de las aberturas, porque podría tocar puntos de tensión peligrosa o cortocircuitar piezas, lo que podría resultar en incendios o descargas eléctricas. No vierta nunca ningún tipo de líquido sobre este aparato.
18. Mantenga los dedos alejados de la bandeja del disco cuando cierre ésta. La bandeja podría causar serios daños personales.
19. No coloque objetos pesados sobre el aparato ni se suba en él. El objeto podría caerse, causando daños personales serios y el aparato podría averiarse seriamente.
20. No utilice discos rajados, deformados, ni reparados. Estos discos podrían romperse fácilmente y causar daños personales serios y el mal funcionamiento del aparato.



Conexión a un televisor

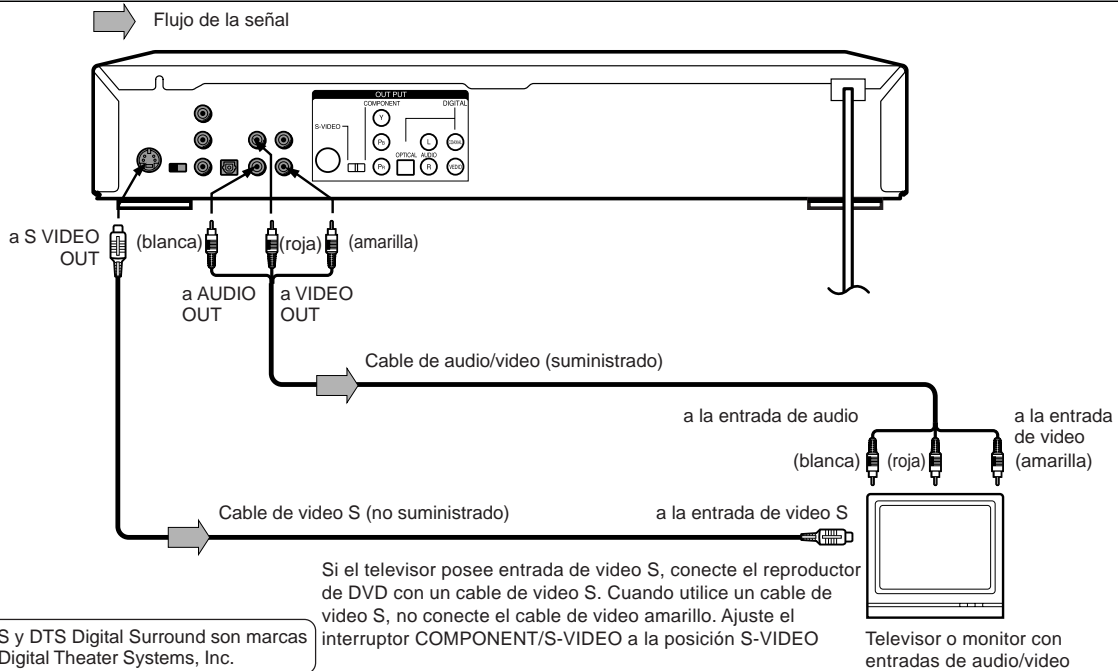

Inserción de las pilas

- **A propósito de las ilustraciones del compartimiento de pilas**
Hay dos tipos de compartimiento de pilas en los controladores remotos proporcionados. (Esto no significa que haya diferencia en el funcionamiento de los mismos.) Vea una u otra ilustración según su controlador remoto actual.

1 Abra la tapa del compartimiento.

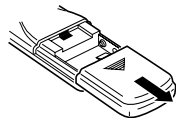

2 Inserte las pilas (tamaño AAA).

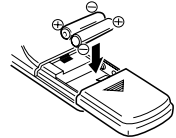

Cerciórese de que + y - de las pilas coincidan con las marcas del interior del compartimiento de las mismas.

3 Cierre la tapa del compartimiento.

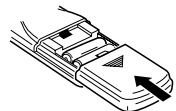

Apunte con el controlador remoto hacia el sensor de control remoto y presione los botones.

Distancia: Unos 7 m (23 feet) de la parte frontal del sensor de control remoto

Ángulo: Unos 30° en cada sentido de la parte frontal del controlador remoto

Reproducción básica

1 Presione el botón de alimentación (POWER).



La alimentación del reproductor de DVD se conectará.

Cuando conecte la alimentación del reproductor de DVD por primera vez, aparecerá un mensaje. Presione ENTER y realice los ajustes apropiados antes de pasar al paso 2 (página siguiente).

2 Presione OPEN/CLOSE.

OPEN/CLOSE



La bandeja del disco se abrirá.

3 Coloque el disco sobre la bandeja del disco.

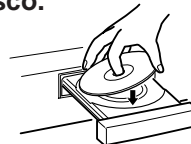

Con la cara de reproducción hacia abajo.

4 Presione OPEN/CLOSE para cerrar la bandeja del disco.

OPEN/CLOSE



La reproducción comenzará.



Reproducción básica (continuación)

■ Selección del idioma OSD

1. Presione SET UP en el modo de parada o no hay disco.
2. Presione ► para seleccionar "Other".
3. Presione ▼ o ENTER. Aparece la pantalla de idioma OSD.
4. Presione ► o ENTER. Aparece el submenú.
5. Presione ▲ o ▼ para seleccionar el idioma deseado.
6. Presione ENTER. El idioma no cambia. (Cambia el idioma de la OSD.)
7. Presione SET UP o RETURN para cerrar la pantalla.

■ Ajuste de la imagen

1. Presione SET UP en el modo de parada o no hay disco.
2. Presione ► para seleccionar "Picture".
3. Presione ▼ o ENTER. Aparece la pantalla de imagen ("Tv Screen" y "Display").
4. Presione ▲ o ▼ para seleccionar "Tv Screen".
5. Presione ► o ENTER.
6. Presione ▲ o ▼ para seleccionar el tipo de pantalla deseado.

4:3 Letterbox:

Cuando haya conectado un televisor de pantalla estándar de 4:3. Las imágenes teatrales se visualizarán con barras de enmascaramiento en la parte superior e inferior de la pantalla.

4:3 Normal:

Cuando haya conectado un televisor de pantalla estándar de 4:3. Las imágenes se visualizarán recortadas para llenar la pantalla del televisor. Se cortarán cualquiera o ambos lados de la imagen.

16:9 Widescreen:

Cuando haya conectado un televisor de pantalla panorámica de 16:9.

7. Presione ENTER.
Se ajusta el tamaño de la pantalla de TV.
8. Presione SET UP o RETURN para cerrar la pantalla.

■ Para realizar una pausa en la reproducción (reproducción de imagen fija)

Presione PAUSE/STEP durante la reproducción.

PAUSE/STEP



Para reanudar la reproducción normal, presione el botón PLAY.

- Durante la reproducción de imagen fija, el sonido estará silenciado.

■ Para parar la reproducción

Presione STOP.



DVD Localización de un título utilizando el menú principal

1 Presione TOP MENU.

En la pantalla del televisor aparecerá el menú principal.

TOP MENU



Ej.

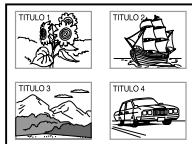

2 Presione ▲/▼/◀/▶ para seleccionar el título deseado.

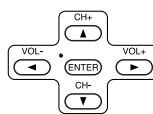

Si los títulos del menú principal tienen asignado un número, usted podrá localizar directamente un título específico introduciendo el número asignado con los botones numéricos.

3 Presione ENTER o PLAY.

La reproducción se iniciará desde el capítulo 1 del título seleccionado.

Reproducción rápida en sentido regresivo o progresivo

Presione REV o FF durante la reproducción.



REW: Reproducción rápida regresiva
FF: Reproducción rápida progresiva
Cada vez que presione el botón REV o FF, la velocidad de reproducción cambiará.

■ Para reanudar la reproducción normal

Presione PLAY.

Reproducción fotograma tras fotograma

Presione PAUSE/STEP durante la reproducción de imagen fija.

PAUSE/STEP



Cada vez que presione el botón PAUSE/STEP, las imágenes avanzarán un fotograma.

■ Para reanudar la reproducción normal

Presione PLAY.

Reproducción a cámara lenta

Presione SLOW ◀| o ▶| durante la reproducción.

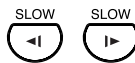

Cada vez que presione el botón SLOW, la velocidad de reproducción a cámara lenta cambiará.

■ Para reanudar la reproducción normal

Presione PLAY.

Localización de un capítulo o pista específico

Presione repetidamente SKIP ◀◀ o ▶▶ para hacer que se visualice el número del capítulo o de la pista que desee.

La reproducción se iniciará desde el capítulo o la pista que haya seleccionado.

SKIP



Para localizar capítulos o pistas posteriores.

SKIP



La reproducción se iniciará desde el comienzo del capítulo o la pista actual. Si presiona el botón dos veces, la reproducción se iniciará desde el comienzo del capítulo o la pista anteriores.

Notas sobre los derechos de autor

La ley prohíbe copiar, difundir, mostrar, emitir por cable, reproducir en público, y alquilar sin permiso material con derechos de autor reservados (copyright).

Los videodiscos DVD están protegidos contra copia y cualquier grabación realizada de estos discos se distorsionará.

Este producto incorpora la tecnología de protección de derechos de autor (Copyright) mediante un método que protege ciertas patentes de EE.UU. y otros derechos de propiedad intelectual pertenecientes a Macrovision Corporation y otros propietarios de derechos. La utilización de esta tecnología de protección deberá ser autorizada por Macrovision Corporation, y tiene como fin la utilización en el hogar y otros usos de contemplación limitados a menos que Macrovision Corporation autorice otra cosa. Está prohibido modificar esta ingeniería y desmontar la unidad.

Fabricado bajo licencia de Dolby Laboratories. "Dolby" y el símbolo de la doble D son marcas comerciales de Dolby Laboratories.