



GO.VIDEO®
DV1130
User's Guide

Safety Precautions



CAUTION
RISK OF ELECTRIC SHOCK
DO NOT OPEN



CAUTION: TO REDUCE THE RISK OF ELECTRIC SHOCK DO NOT REMOVE COVER (OR BACK) NO USER-SERVICEABLE PARTS INSIDE REFER SERVICING TO QUALIFIED SERVICE PERSONNEL.



This lightning flash with arrowhead symbol within an equilateral triangle is intended to alert the user to the presence of uninsulated dangerous voltage within the product's enclosure that may be of sufficient magnitude to constitute a risk of electric shock to persons.



The exclamation point within an equilateral triangle is intended to alert the user to the presence of important operating and maintenance (servicing) instructions in the literature accompanying the product.

WARNING: TO REDUCE THE RISK OF FIRE OR ELECTRIC SHOCK, DO NOT EXPOSE THIS APPARATUS TO RAIN OR MOISTURE.

CAUTION: TO PREVENT ELECTRIC SHOCK, MATCH WIDE BLADE OF PLUG TO WIDE SLOT, FULLY INSERT.

ATTENTION: POUR ÉVITER LES CHOC ÉLECTRIQUES, INTRODUIRE LA LAME LA PLUS LARGE DE LA FICHE DANS LA BORNE CORRESPONDANTE DE LA PRISE ET POUSSER JUSQU'AU FOND.

WARNING: Do not install this equipment in a confined space such as a bookcase or similar unit.

NOTE TO CABLE/TV INSTALLER: This reminder is provided to call the cable TV system installer's attention to Article 820-40 of the National Electric Code (U.S.A.). The code provides guidelines for proper grounding and, in particular, specifies that the cable ground shall be connected to the grounding system of the building, as close to the point of the cable entry as practical.

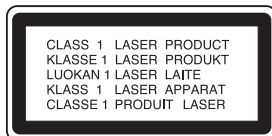

CAUTION:

This DVD+VCR employs a Laser System.

To ensure proper use of this product, please read this owner's manual carefully and retain for future reference. Should the unit require maintenance, contact an authorized service location.

Use of controls, adjustments, or the performance of procedures other than those specified herein may result in hazardous radiation exposure.

To prevent direct exposure to laser beam, do not try to open the enclosure. Visible laser radiation when open.
DO NOT STARE INTO BEAM.

CAUTION: The apparatus should not be exposed to water (dripping or splashing) and no objects filled with liquids, such as vases, should be placed on the apparatus.

FCC WARNING: This equipment may generate or use radio frequency energy. Changes or modifications to this equipment may cause harmful interference unless the modifications are expressly approved in the instruction manual. The user could lose the authority to operate this equipment if an unauthorized change or modification is made.

REGULATORY INFORMATION: FCC Part 15

This product has been tested and found to comply with the limits for a Class B digital device, pursuant to Part 15 of the FCC Rules. These limits are designed to provide reasonable protection against harmful interference when the product is operated in a residential installation. This product generates, uses, and can radiate radio frequency energy and, if not installed and used in accordance with the instruction manual, may cause harmful interference to radio communications. However, there is no guarantee that interference will not occur in a particular installation. If this product does cause harmful interference to radio or television reception, which can be determined by turning the product off and on, the user is encouraged to try to correct the interference by one or more of the following measures:

- Reorient or relocate the receiving antenna.
- Increase the separation between the product and receiver.
- Connect the product into an outlet on a circuit different from that to which the receiver is connected.
- Consult the dealer or an experienced radio/TV technician for help.



NOTES ON COPYRIGHTS:

It is forbidden by law to copy, broadcast, show, broadcast via cable, play in public, or rent copyrighted material without permission.

This product uses copyright protection developed by Macrovision. Copy protection signals are recorded on some discs. When recording and playing the pictures of these discs on a VCR, picture noise will appear.

This product incorporates copyright protection technology that is protected by method claims of certain U.S. patents and other intellectual property rights owned by Macrovision Corporation and other rights owners. Use of this copyright protection technology must be authorized by Macrovision Corporation, and is intended for home and other limited viewing uses only unless otherwise authorized by Macrovision Corporation. Reverse engineering or disassembly is prohibited.

SERIAL NUMBER: The serial number is found on the back of this unit. This number is unique to this unit and not available to others. You should record requested information here and retain this guide as a permanent record of your purchase.

Model No. _____

Serial No. _____

IMPORTANT SAFETY INSTRUCTIONS

CAUTION: PLEASE READ AND OBSERVE ALL WARNINGS AND INSTRUCTIONS IN THIS OWNER'S MANUAL AND MARKED ON THE PRODUCT. RETAIN THIS BOOKLET FOR FUTURE REFERENCE.

This product has been designed and manufactured to assure personal safety. Improper use can result in electric shock or fire hazard. The safeguards incorporated in this product will protect you if you observe the following procedures for installation, use, and servicing. This product does not contain any parts that can be repaired by the user.

DO NOT REMOVE THE CABINET COVER, OR YOU MAY BE EXPOSED TO DANGEROUS VOLTAGE. REFER SERVICING TO QUALIFIED SERVICE PERSONNEL ONLY.

- 1. Read these instructions.** - All these safety and operating instructions should be read before the product is operated.
- 2. Keep these instructions.** - The safety, operating and use instructions should be retained for future reference.
- 3. Heed all warnings.** - All warnings on the product and in the operating instructions should be adhered to.
- 4. Follow all instructions.** - All operating and use instructions should be followed.
- 5. Do not use this product near water.** - For example: near a bath tub, wash bowl, kitchen sink, laundry tub, in a wet basement; or near a swimming pool; and other areas located near water.
- 6. Clean only with dry cloth.** - Unplug this product from the wall outlet before cleaning. Do not use liquid cleaners.
- 7. Do not block any ventilation openings. Install in accordance with the manufacturer's instructions.** - Slots and openings in the cabinet are provided for ventilation and to ensure reliable operation of the product and to protect it from over-heating. The openings should never be blocked by placing the product on a bed, sofa, rug or other similar surface. This product should not be placed in a built-in installation such as a bookcase or rack unless proper ventilation is provided or the manufacturer's instructions have been adhered to.
- 8. Do not install near any heat sources such as radiators, heat registers, stoves, or other apparatus (including amplifiers) that produce heat.**
- 9. Do not defeat the safety purpose of the polarized or grounding-type plug.** A polarized plug has two blades with one wider than the other. A grounding type plug has two blades and a third grounding prong. The wide blade or the third prong are provided for your safety. If the provided plug does not fit into your outlet, consult an electrician for replacement of the obsolete outlet.
- 10. Protect the power cord from being walked on or pinched particularly at plugs, convenience receptacles, and the point where they exit from the product.**
- 11. Only use attachments/accessories specified by the manufacturer.**
- 12. Use only with the cart, stand, tripod, bracket, or table specified by the manufacturer, or sold with apparatus. When a cart is used, use caution when moving the cart/product combination to avoid injury from tip-over.**
- 13. Unplug this product during lightning storms or when unused for long periods of time.**
- 14. Refer all servicing to qualified service personnel. Servicing is required when the product has been damaged in any way, such as power-supply cord or plug is damaged, liquid has been spilled or objects have fallen into the product, the product has been exposed to rain or moisture, does not operate normally, or has been dropped.**



Table of Contents

Introduction

Safety Precautions	2
IMPORTANT SAFETY INSTRUCTIONS	3
Table of Contents	4
Before Use	5-6
Playable Discs	5
Precautions	6
Notes on Discs	6
About Symbols	6
Front Panel Controls	7
Front Panel Display	8
Remote Control	9
Connections Panel	10

Preparation

Connections	11-14
Connecting Antenna/Cable TV to DVD+VCR	11
Basic TV Connections	12
Optional, Preferred TV Connections	13-14
VCR Operation Setup	15-17
On-Screen Display (OSD)	15
Setting the On-Screen Display	15
VCR Setup Menu Options	16
Channel Selection	16
Setting the Clock	17
DVD Operation Setup	18-21
General Explanation	18
On-Screen Display	18
Initial Settings	19-21
• General Operation	19
• Language	19
• Picture	19
• Progressive Scan	19
• Sound	20
• Others	20
• Parental Control	21

Operation

VCR Operation	22-27
Normal Playback	22
Special Effect Playbacks	22
• Search	22
• Still Picture and Frame-by-Frame Playback	22
• Slow Motion	22
• Commercial Skip	22
Normal Recording	23
Timer Recording	23-24
Instant Timer Recording	25
Dubbing and Editing	25
Copying from DVD to VCR	25
VHS Hi-Fi Stereo System/MTS Broadcast	26
Tape Counter Memory Feature	27
Additional Information	27
DVD Operation	28-30
Playing DVD	28
General Features	28
• Moving to another TITLE	28
• Moving to another CHAPTER	28
• Slow Motion	28
• Still Picture and Frame-by-Frame Playback	29
• Search	29
• Random	29
• Repeat	29
• Repeat A-B	29
• Time Search	29

• 3D Surround	29
• Zoom	29
• Marker Search	30
• Changing Video Mode	30
Special DVD Features	30
• Checking the contents of DVD Video discs: Menus	30
• Title Menu	30
• Disc Menu	30
• Camera Angle	30
• Changing the Audio Language	30
• Subtitle	30
Audio CD Operation	31
Playing an Audio CD	31
• Pause	31
• Moving to another Track	31
• Repeat Track/ All/ Off	31
• Search	31
• Random	31
• Repeat A-B	31
• 3D Surround	31
• Changing the Audio Channel	31
MP3 Disc Operation	32
Playing MP3 Discs	32
• Pause	32
• Moving to another Track	32
• Repeat Track/All/Off	32
• Notes on MP3 Discs	32
JPEG Disc Operation	33
Viewing JPEG Files on a Disc	33
• Moving to another File	33
• Repeat All/ Off	33
• Notes on JPEG Files	33
WMA Disc Operation	34
Playing WMA Discs	34
• Pause	34
• Moving to another Track	34
• Repeat Track/ All/ Off	34
Programmed Playback	35
Programmed Playback with Audio CD, MP3 JPEG and WMA Discs	35
• Repeat Programmed Tracks/All/Off	35
• Repeat Programmed All/Off	35
• Erasing a Track/File from Program List	35
• Erasing the Complete Program List	35
Reference	
Troubleshooting	36-37
Language Code List	38
Country Code List	39
Specifications	40
Notes	41-43
Warranty	Back Cover

About the symbols for instructions



 Indicates hazards likely to cause harm to the unit itself or other material damage.

 Indicates special operating features of this unit.

 Indicates tips and hints for making the task easier.

Before Use

Playable Discs

	DVD (8 cm/12 cm disc)
	Audio CD (8 cm/12 cm disc)

In addition, this unit can play CD-Rs or CD-RWs that contain audio titles, MP3, JPEG, or WMA files.

Notes

- Depending on the conditions of the recording equipment or the CD-R/RW disc itself, some CD-R/RW discs cannot be played on the unit.
- The unit cannot play discs that contain data other than MP3 and CD-DA data.
- Do not attach any seal or label to either side (the labeled side or the recorded side) of a disc.
- Do not use irregularly shaped CDs (e.g., heart-shaped or octagonal). The unit may malfunction.

Notes on DVDs

Some playback operations of DVDs may be intentionally fixed by software manufacturers. As this unit plays DVDs according to disc content designed by the software manufacturer, some playback features of the unit may not be available or other functions may be added. Refer also to the instructions supplied with the DVDs. Some DVDs made for business purposes may not be played on the unit.

Regional code of this DVD+VCR and DVDs

This DVD+VCR is designed and manufactured for playback of Region 1 encoded DVD software.  The region code on the labels of some DVD discs indicate which type of DVD+VCR can play those discs. This unit can play only DVD discs labeled 1 or ALL. If you try to play any other discs, the message "Check Regional Code" will appear on the TV screen. Some DVD discs may not have a region code label even though their playback is prohibited by area limits.

Note on DTS-encoded CDs

When playing DTS-encoded CDs, excessive noise may be heard from the analog stereo output. To avoid possible damage to the audio system, turn down the volume before playing back such discs, adjust the volume gradually, and keep the volume level low. To enjoy DTS Digital Surround™ playback, an external 5.1 channel Digital Surround™ decoder system must be connected to the digital output of the unit.

Disc-related Terms

Title (DVD only)

The main film content or accompanying feature content or music album.

Each title is assigned a title reference number enabling you to locate it easily.

Chapter (DVD only)

Sections of a picture or a musical piece that are smaller than titles. A title is composed of one or several chapters. Each chapter is assigned a chapter number to enable you to locate the chapter you want. Depending on the disc, the DVD may not be divided into chapters.

Track (Audio CD only)

Sections of a musical piece on an audio CD. Each track is assigned a track number, enabling you to locate the track you want.

Remote Control Battery Installation

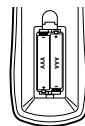

Detach the battery cover on the rear of the remote control, and insert two AAA batteries with \oplus and \ominus aligned correctly.

Caution

Do not mix old and new batteries. Never mix different types of batteries (standard, alkaline, etc.).

Remote Control Operating Range

Point the remote control at the remote sensor and press the buttons.

- **Distance:** About 23 ft (7 m) from the front of the remote sensor
- **Angle:** About 30° in each direction of the front of the remote sensor

IMPORTANT NOTE:

SPENT OR DISCHARGED BATTERIES MUST BE RECYCLED OR DISPOSED OF IN A SAFE MANNER IN COMPLIANCE WITH ALL APPLICABLE LAWS. FOR DETAILED INFORMATION, CONTACT YOUR LOCAL COUNTY SOLID WASTE AUTHORITY.

Manufactured under license from Dolby Laboratories. Dolby and the double-D symbol are trademarks of Dolby Laboratories. Confidential unpublished works. Copyright 1992-1997 Dolby Laboratories. All rights reserved.

DTS and DTS Digital Out are trademarks of Digital Theater Systems, Inc.

Before Use (Continued)

Precautions

Handling the unit

When shipping the unit

The original shipping carton and packing materials come in handy. For maximum protection, re-pack the unit as it was originally packaged at the factory.

When setting up the unit

The picture and sound of a nearby TV, VCR, or radio may be distorted during playback. In this case, position the unit away from the TV, VCR, or radio, or turn off the unit after removing the disc.

To keep the surface clean

Do not use volatile liquids, such as insecticide spray, near the unit. Do not leave rubber or plastic products in contact with the unit for a long period of time. They will leave marks on the surface.

Cleaning the unit

To clean the cabinet

Use a soft, dry cloth. If the surfaces are extremely dirty, use a soft cloth lightly moistened with a mild detergent solution. Do not use strong solvents such as alcohol, benzene, or thinner, as these might damage the surface of the unit.

To obtain a clear picture

The DVD+VCR is a high-tech, precision device. If the optical pick-up lens and disc drive parts are dirty or worn, the picture quality will be poor. Regular inspection and maintenance are recommended after every 1,000 hours of use. (This depends on the operating environment.) For details, please contact your nearest dealer.

Notes on Discs

Handling discs

Do not touch the playback side of the disc. Hold the disc by the edges so that fingerprints will not get on the surface. Do not stick paper or tape on the disc.

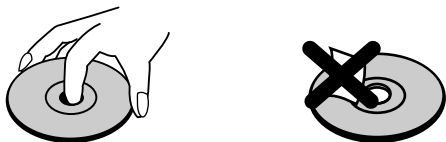

Storing discs

After playing, store the disc in its case. Do not expose the disc to direct sunlight or sources of heat, or leave it in a parked car exposed to direct sunlight, as there may be a considerable temperature increase inside the car.

Cleaning discs

Fingerprints and dust on the disc can cause poor picture quality and sound distortion. Before playing, clean the disc with a clean cloth. Wipe the disc from the center out.

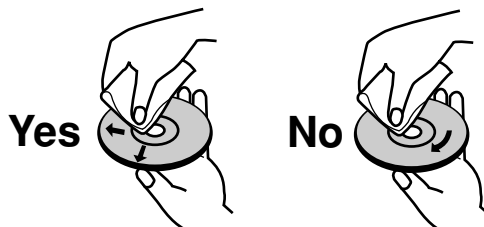

Do not use strong solvents such as alcohol, benzene, thinner, commercially available cleaners, or anti-static spray intended for older vinyl records.



About Symbols

About the symbol display

“” may appear on the TV screen during operation. This icon means the function explained in this owner's manual is not available on that specific DVD video disc.

About the disc symbols for instructions

A section whose title has one of the following symbols are applicable only to those discs represented by the symbol.

-  DVDs.
-  Audio CDs.
-  MP3 Discs.
-  JPEG Discs.
-  WMA Discs.

Selecting the Viewing Source

You must select one of your output sources (DVD or VCR) to view on the TV screen.

- **If you want to view the DVD deck:**
Press DVD on the remote control or DVD/VCR on the front panel until the DVD indicator on the front panel display lights and output from the DVD deck is viewed on the TV screen.
- **If you want to view the VCR deck:**
Press VCR on the remote control or DVD/VCR on the front panel until the VCR indicator on the front panel display lights and output from the VCR deck is viewed on the TV screen.

otes

- If you insert a disc while the DVD+VCR is in VCR mode, the DVD+VCR will switch to DVD mode automatically.
- If you insert a cassette tape without a record safety tab while the DVD+VCR is in DVD mode, the DVD+VCR will switch to VCR mode automatically.

Front Panel Controls

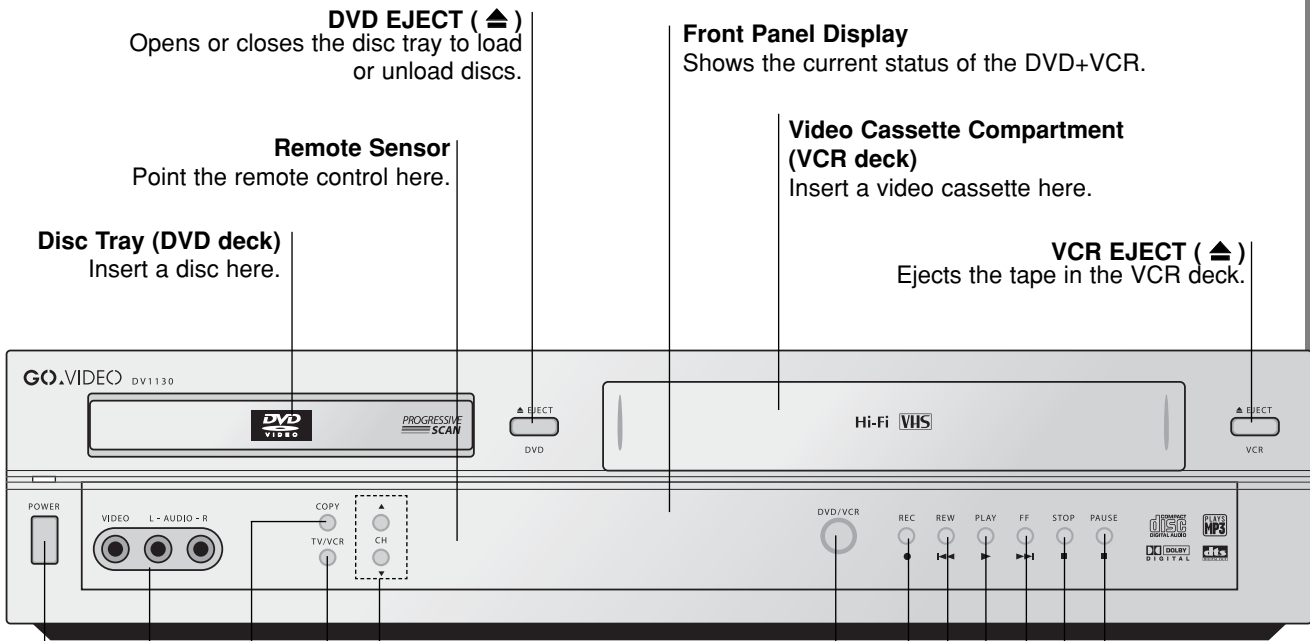

DVD EJECT (▲)
Opens or closes the disc tray to load or unload discs.

Remote Sensor
Point the remote control here.

Disc Tray (DVD deck)
Insert a disc here.

Front Panel Display
Shows the current status of the DVD+VCR.

Video Cassette Compartment (VCR deck)
Insert a video cassette here.

VCR EJECT (▲)
Ejects the tape in the VCR deck.

POWER

VIDEO L - AUDIO - R

COPY
TV/VCR

CH
▲
▼

DVD/VCR

REC

REW

PLAY

FF

STOP

PAUSE

MP3
DIGITAL
DOLBY
DIGITAL

DVD/VCR
Switches control between the DVD deck and the VCR deck.

CH (▲/▼)
Scans up or down through memorized channels.

REC
To record normally or to activate One-Touch Recording.

PAUSE (||)
Pauses playback or recording temporarily. Press repeatedly for frame-by-frame playback.

STOP (■)
Stops playback.

TV/VCR
Switches between your TV tuner and the DVD+VCR tuner.

COPY
Copies a DVD in the DVD deck to a VHS tape in the VCR deck.

REW (◀◀)
DVD: Skips to start of current chapter/track or to previous chapter/track. Press and hold for fast reverse search.
VCR: Rewinds the tape during Stop mode or scans backward in Play mode.

FF (▶▶)
DVD: Skips to NEXT chapter/track. Press and hold for fast-forward search.
VCR: Fast forwards the tape during Stop mode or scans forward in Play mode.

VIDEO IN/AUDIO IN (Left/Right)
Connects to the audio/video output of an external source (audio system, TV/monitor, another VCR).

PLAY
Plays back a recorded tape or disc.

POWER
Turns the DVD+VCR ON and OFF.

Child Lock

The Child Lock feature disables the front panel buttons to prevent children from tampering with the DVD+VCR. Simply press CHILD LOCK on the remote control to toggle this feature on and off.

Front Panel Display

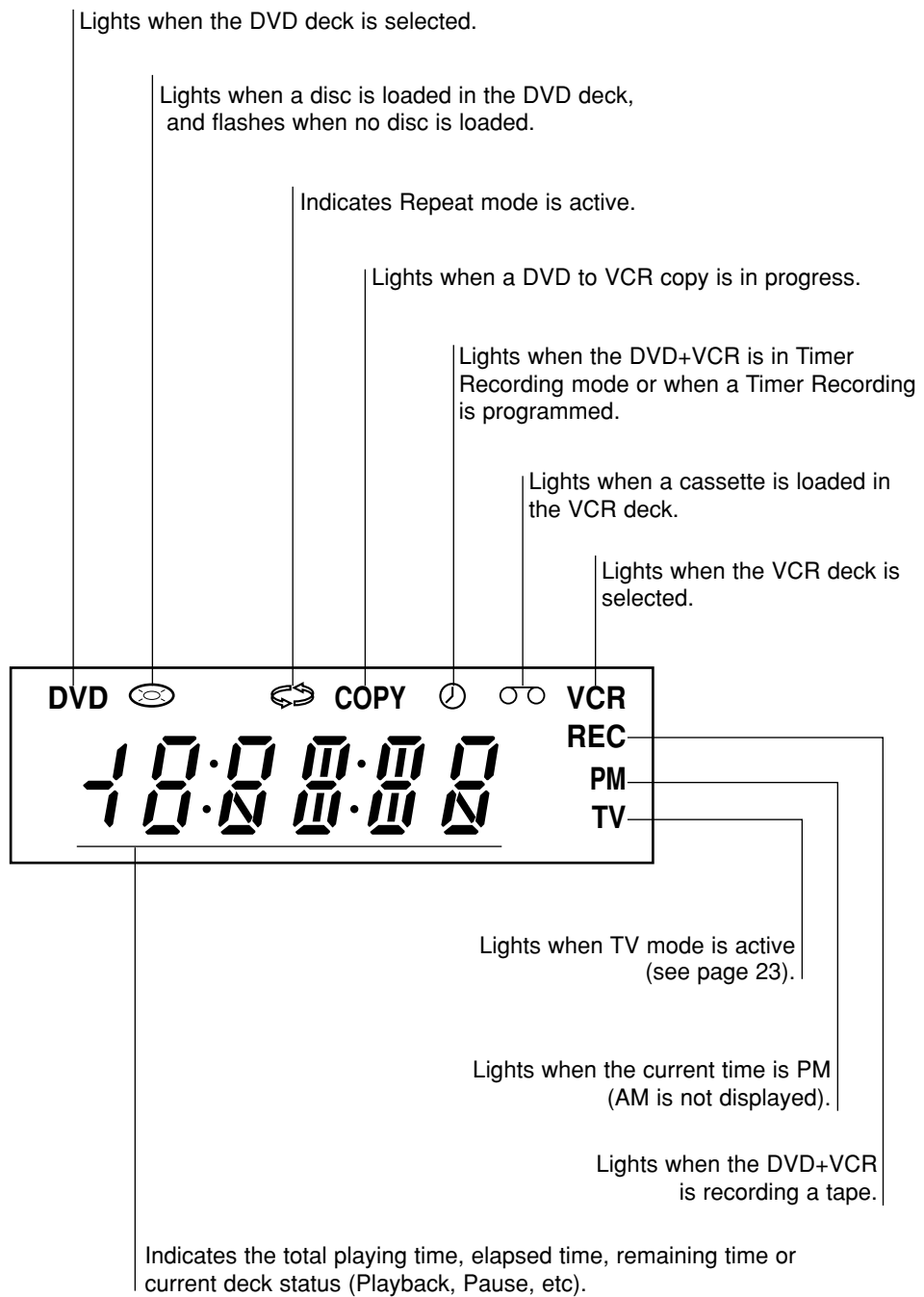

Remote Control

DVD & VCR select buttons
Sets the remote control to operate either the DVD deck or the VCR deck.

POWER
Turns the DVD+VCR ON and OFF.

TV/VCR
Switches between your TV tuner and the DVD+VCR tuner.

DISPLAY
Accesses the on-screen display.
Switches among the clock, tape counter and tape remaining modes on the display.

◀▶ ▲ ▼ (left/right/up/down)
- Selects menu items
- **CH(▲/▼)**: Selects channels on the VCR.
- **TRK(+/-)**: Manually adjusts tracking.

SETUP/MENU
Opens or exits DVD setup menu and VCR menu.

TITLE ●
Displays the disc's Title, if available.

PAUSE/STEP (||) ●
Pauses playback or recording temporarily. Press repeatedly for frame-by-frame playback.

STOP (■) ●
Stops playback.

REC ●
Records normally or activates Instant Timer Recording.

0-9 number buttons
Selects channels or menu items.

AUDIO ●
Selects DVD audio languages or CD audio channels (Stereo/Left/Right).

SUBTITLE ●
Selects available subtitle languages.

REPEAT ●
Repeats chapters, tracks, titles or all.

CHILD LOCK ●
Disables front panel buttons.

RANDOM/SKIP ●
- Plays tracks in random order.
- Scans ahead 30 during VHS playback.

A-B/SP/EP ●
- Repeats playback between two points.
- Selects recording speed

SEARCH ●
Displays MARK SEARCH menu.

EJECT
- Opens and closes the disc tray.
- Ejects the tape in the VCR deck.

INPUT
Selects the VCR deck's source (Tuner, LINE 1, or LINE 2).

ENTER
- Confirms menu selections.
- Displays functions on the TV screen.

DISC MENU
Opens menu on a DVD disc.

RETURN
Exits the setup menu.

● FF (▶▶) ()
DVD: Skips to NEXT chapter/track. Press and hold for fast-forward search.
VCR: Fast forwards the tape during Stop mode or scans forward in Play mode.

● PLAY (▶) ()
Starts playback.

● REW (◀◀) ()
DVD: Skips to start of current chapter/track or to previous chapter/track. Press and hold for fast reverse search.
VCR: Rewinds the tape during Stop mode or scans backward in Play mode.

PROG.PLAY
Selects or exits Program menu.

CLEAR
Removes a track number on the Program menu or a mark on the MARK SEARCH menu. Also clears VCR tape counter settings.

● ANGLE
Selects a DVD camera angle if available.

● ZOOM
Magnifies video image.

● MARK
Marks any point during playback.

● LAST CH
Displays last channel viewed.

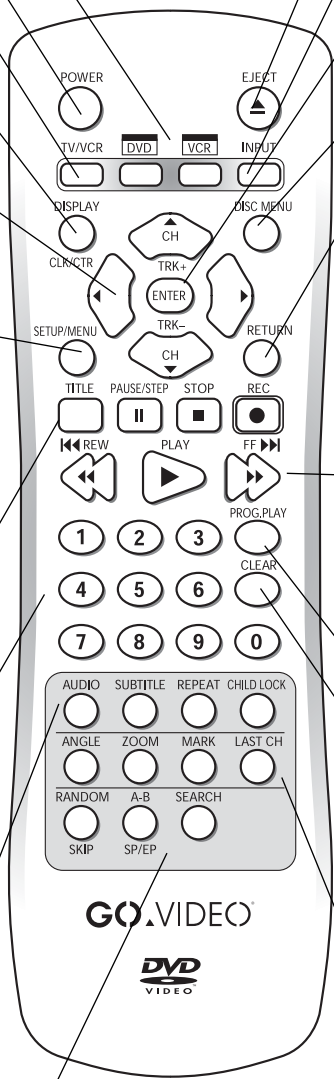

Note

The remote control uses one set of playback buttons to operate both decks:
To use the VCR, first press the VCR button.
To use the DVD, first press the DVD button.

Connections Panel

DVD/VCR OUT (VIDEO/AUDIO (Left/Right))
Connects to a TV with video and audio inputs.

COMPONENT/PROGRESSIVE SCAN VIDEO OUT (Y Pb Pr) (DVD OUT) Connects to a TV with Y Pb Pr inputs.

VCR IN LINE 1 (VIDEO IN/AUDIO IN (Left/Right))
Connects to the audio/video output of an external source (audio system, TV/monitor, another VCR).

AUDIO OUT (Left/Right) (DVD OUT)
Connects to a TV, amplifier, receiver, or stereo system.

S-VIDEO OUT (DVD OUT)
Connects to an S-Video Input on your TV.

AC Power Cord
Plugs into a power source.

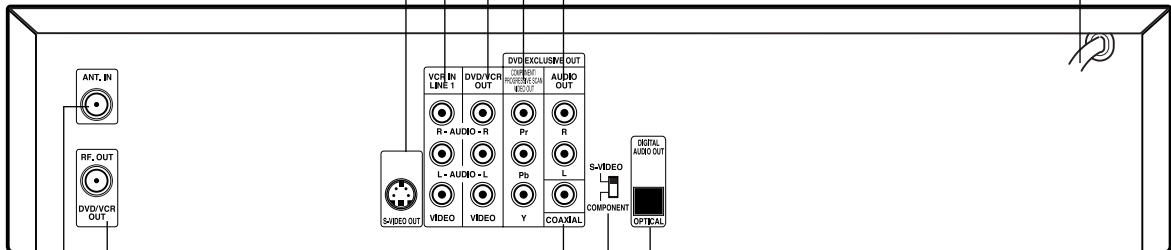

RF OUT(DVD/VCR OUT)
Connects to an RF coaxial input on your TV.

DIGITAL AUDIO OUT (OPTICAL) (DVD OUT)
Connects to digital (optical) audio equipment.

Video Output Select Switch
Selects either S-VIDEO OUT or COMPONENT VIDEO OUT, depending on how you have connected the DVD+VCR to your TV.

DIGITAL AUDIO OUT (COAXIAL) (DVD OUT)
Connects to digital (coaxial) audio equipment.

ANTENNA INPUT
Connects to a VHF/UHF/CATV antenna.



Do not touch the inner pins on the rear panel jacks. Electrostatic discharge may cause permanent damage to the unit.

Connections

Tips

- For instructions on the various ways to connect the DVD+VCR to your TV and other equipment, please refer to pages 11-14.
- Please refer to the manuals of your TV, VCR, stereo system or other devices as necessary to make the best connections.
- For better sound reproduction, connect the DVD+VCR's DVD/VCR AUDIO OUT jack to the audio in jacks of your amplifier, receiver, stereo or audio/video equipment. See *Optional, Preferred TV Connections* on pages 13-14.

Caution

- Make sure the DVD+VCR is connected directly to the TV. Tune the TV to the correct video input channel.
- Do not connect the DVD+VCR's DVD/VCR AUDIO OUT jack to the phono in jack (record deck) of your audio system.
- Do not connect your DVD+VCR via your VCR. The DVD image could be distorted by the copy protection system.

Connecting Antenna/Cable TV to DVD+VCR

- 1 Disconnect the antenna leads from the rear of your TV.
- 2 Identify the type of cable from your antenna. If it is a round cable as illustrated, it is a 75 ohm coaxial antenna cable. This cable will connect directly to the jack marked ANT.IN on your DVD+VCR.

Tip

If your antenna lead wire is a flat type antenna cable, connect it to a 300-ohm to 75-ohm Antenna Adapter (not supplied), and slip the Adapter onto the ANT.IN jack. The Adapter does not screw on to the DVD+VCR, it just slips over the jack.

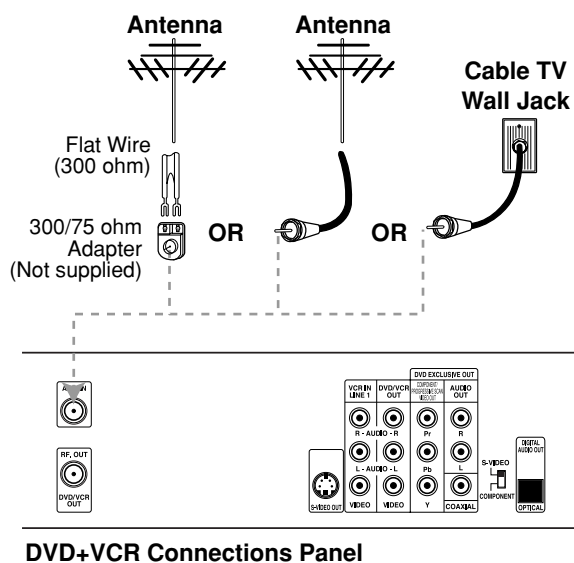

Without Cable Box

If your cable wire is connected to your TV without a converter or descrambler box, unscrew the wire from your TV and attach it to the ANT.IN jack on the DVD+VCR. Use the supplied coaxial cable to connect between the DVD+VCR's RF.OUT jack and the 75 ohm antenna input jack on the TV. With this connection, you can receive all midband, super band, and hyperband channels.

With Cable Box

If a cable box is required in your cable system, follow the instruction below:
The cable hookup permits both TV and DVD+VCR operation.

To view or record CATV channels

- 1 Tune the TV to the DVD+VCR output channel (CH 3 or 4).
- 2 Set the DVD+VCR channel selector to the output channel of the cable box by using the CH/TRK (▲/▼) or number (0-9) of your DVD+VCR. (Example: CH3)
- 3 Select the channel to view at the cable box.

Notes

- With this connection, you CANNOT record one program while viewing another.
- If you are using a cable box to tune channels, it is not necessary to do Auto Channel Programming as indicated on page 16.

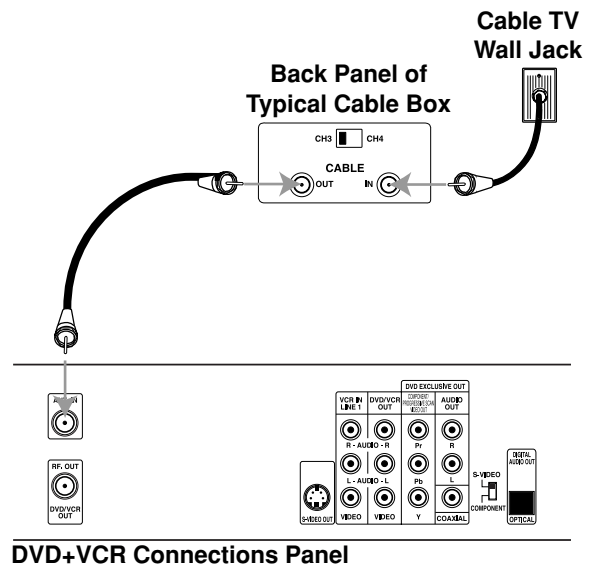

Connections (Continued)

Basic TV Connections

- Make one of the following connections, depending on the capabilities of your existing equipment.

RF coaxial connection

Connect the RF.OUT jack on the DVD+VCR to the antenna in jack on your TV using the supplied 75-ohm coaxial cable (**R**).

Note

If you use this connection, tune the TV to the DVD+VCR's RF output channel (CH 3 or 4).

How to set the DVD+VCR's RF output channel

1. While the DVD+VCR is turned off, press and hold CH (▲/▼) on the front panel for about five seconds. The unit will turn itself on and "RF 03" or "RF 04" appears on the front panel display.
2. Use CH (▲/▼) on the front panel or CH/TRK (▲/▼) on the remote control to change the RF output channel (CH 03 or CH 04).
3. Turn the DVD+VCR off and then on.
4. Set the TV to channel 3 or 4 depending on the RF output channel you selected. Now you can watch the DVD+VCR playback on CH3 or CH4 of your TV.

Audio/Video connection

- 1 Connect the DVD/VCR VIDEO OUT jack on the DVD+VCR to the video in jack on your TV using the supplied video cable (**V**).
- 2 Connect the Left and Right DVD/VCR AUDIO OUT jacks on the DVD+VCR to the audio left/right in jacks on your TV (**A1**) using the supplied audio cables.

Note

If you use this connection, set the TV's source selector to VIDEO (sometimes referred to as Line, Aux, Input, etc.).

TV Connections Panel

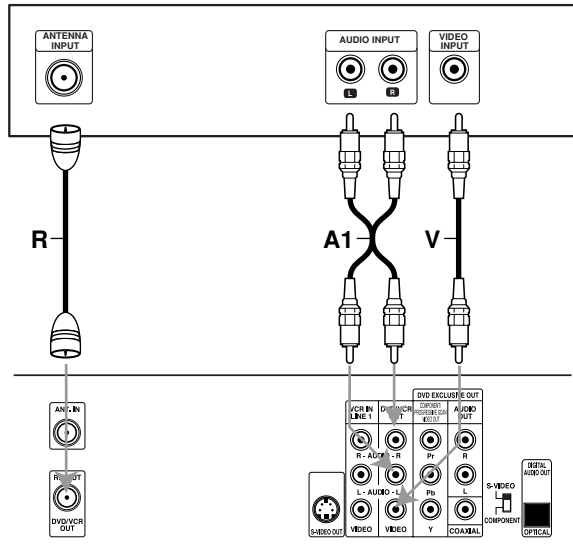

DVD+VCR Connections Panel

Connections (Continued)

Optional, Preferred TV Connections

Notes

- The connections described below are for DVD playback ONLY.
- When using the COMPONENT/PROGRESSIVE SCAN VIDEO OUT jacks, set the video output select switch to COMPONENT. When using the S-VIDEO OUT jack, set the video output select switch to S-VIDEO.

S-Video connection

1 Connect the S-VIDEO OUT jack on the DVD+VCR to the S-Video in jack on your TV using the optional S-Video cable (S).

2 Connect the Left and Right AUDIO OUT jacks of the DVD+VCR to the audio left/right in jacks on your TV using the supplied audio cables (A2).

Component Video (Color Stream®) connection

1 Connect the COMPONENT/PROGRESSIVE SCAN VIDEO OUT jacks on the DVD+VCR Player to the corresponding in jacks on your TV using an optional Y Pb Pr cable (C).

2 Connect the Left and Right AUDIO OUT jacks of the DVD+VCR to the audio left/right in jacks on your TV (A2) using the supplied audio cables.

Progressive Scan (ColorStream® pro) connection

- If your television is a high-definition or “digital ready” television, you may take advantage of the DVD+VCR’s progressive scan output for the highest video resolution possible.
- If your TV does not accept the Progressive Scan format, the picture will appear scrambled if you select Progressive Scan output from the DVD+VCR.

1 Connect the COMPONENT/PROGRESSIVE SCAN VIDEO OUT jacks on the DVD+VCR to the corresponding in jacks on your TV using an optional Y Pb Pr cable (C).

2 Connect the Left and Right AUDIO OUT jacks of the DVD+VCR to the audio left/right in jacks on your TV (A2) using the supplied audio cables.

Notes

- Set Progressive to “On” in the Setup menu, see page 19.
- Progressive scan does not function simultaneously with the analog video connections (yellow VIDEO OUT jack).

TV Connections Panel

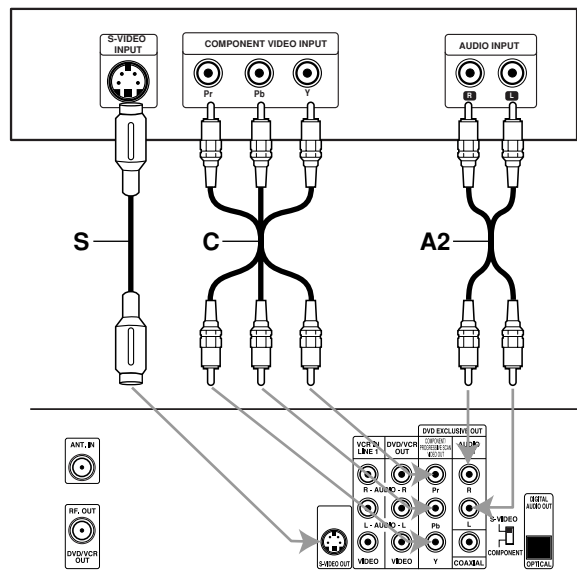

DVD+VCR Connections Panel

Note

If your TV has an S-video input, connect the DVD+VCR with an S-video cable. When using an S-video cable, do not connect the yellow video cable.

Connections (Continued)

Optional, Preferred TV Connections

Note

You can ONLY listen to DVD playback using the COAXIAL (X), OPTICAL (O) and AUDIO OUT (A2) connections. The tuner and VCR will still be heard through the RF.OUT (R) or DVD/VCR AUDIO OUT (A1) jack. (See page 12.)

Connecting to an Amplifier Equipped with 2-Channel Analog Stereo or Dolby Surround

Connect the Left and Right AUDIO OUT (or DVD/VCR AUDIO OUT) jacks on the DVD+VCR to the audio left and right in jacks on your amplifier, receiver, or stereo system using the audio cables (for A1 or A2 connection) supplied.

Connecting to an Amplifier Equipped with 2-Channel Digital Stereo (PCM) or to an Audio/Video Receiver Equipped with Multi-channel Decoder (Dolby Digital™, MPEG 2, or DTS)

1 Connect one of the DVD+VCR's DIGITAL AUDIO OUT jacks (COAXIAL X or OPTICAL O) to the corresponding in jack on your amplifier. Use an optional digital (COAXIAL X or OPTICAL O) audio cable.

2 You will need to activate the DVD+VCR's digital output. (See "Digital Audio Output" on page 20).

Digital Multi-channel Sound

A digital multi-channel connection provides the best sound quality. For this you need a multi-channel Audio/Video receiver that supports one or more of the audio formats supported by your DVD+VCR (MPEG 2, Dolby Digital and/or DTS). Check the receiver manual and the logos on the front of the receiver.

Caution:

Due to the DTS Licensing agreement, the digital output will be in DTS digital out when DTS audio stream is selected.

Notes

- If the audio format of the digital output does not match the capabilities of your receiver, the receiver will produce a strong, distorted sound or no sound at all.
- 6-channel digital surround sound via the digital connection can only be obtained if your receiver is equipped with a digital multi-channel decoder.
- To see the audio format of the current DVD in the on-screen display, press AUDIO.

DVD+VCR Connections Panel

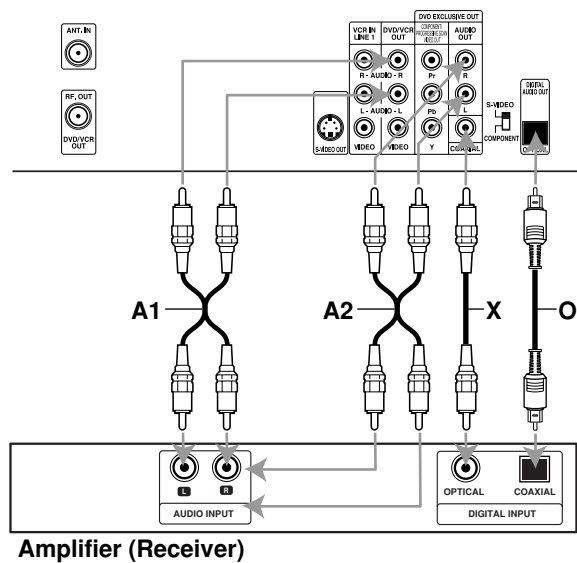

Accessory Audio/Video (A/V) Connections to DVD+VCR

Connect the VCR IN LINE 1 or LINE 2 jacks on the DVD+VCR to the audio/video out jacks on your accessory component, using the optional audio/video cables.

Accessory Component:
VCR, Camcorder,
Video Camera,
Satellite Receiver,
Laser Disc Player, etc.

Accessory Device Jack Panel

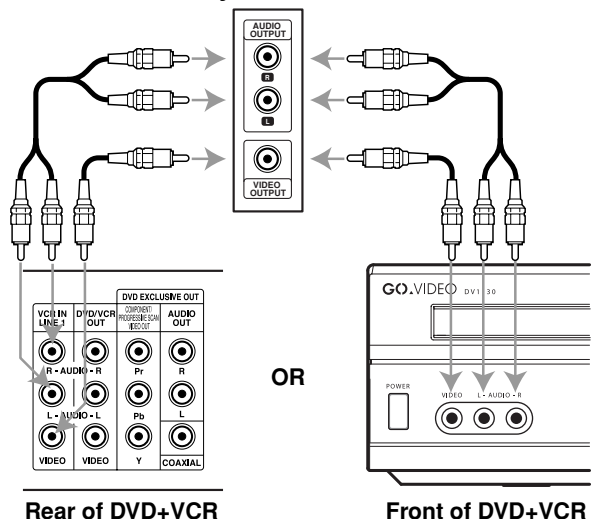

VCR Operation Setup

On-Screen Display (OSD)

The OSD provides feedback during VCR operation.

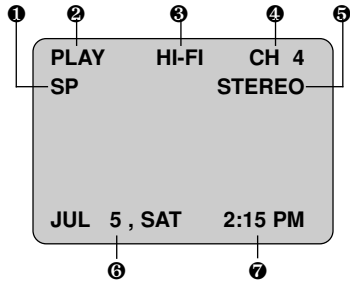

- ❶ **TAPE SPEED DISPLAY**
Shows the current tape speed.
- ❷ **FUNCTION DISPLAY**
Indicates the function in progress.
- ❸ **HI-FI DISPLAY**
Indicates the unit is playing back tape recorded in Hi-Fi.
- ❹ **CHANNEL DISPLAY**
Indicates the selected channel (or LINE1, LINE2).
- ❺ **STEREO/SAP DISPLAY (MONO is not displayed)**
Shows the type of audio signal received by the VCR tuner.
- ❻ **DATE DISPLAY**
Shows the current date (month/date/day of the week).
- ❼ **CLOCK/COUNTER/REMAIN DISPLAY**
Shows the current time, the tape counter and remaining time on the tape.

Each press of the **ENTER** button changes the on-screen display in the following sequence:

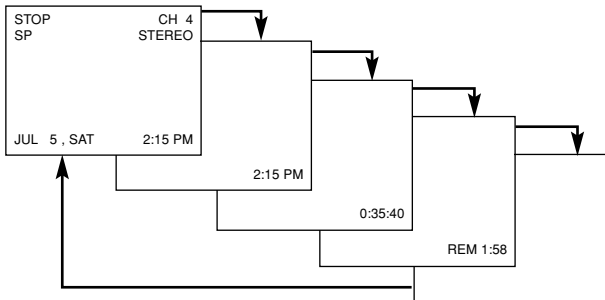

Notes

- On-screen displays appear for ~5 seconds.
- The clock, tape counter, and tape remaining modes will remain on-screen until you press **ENTER**.
- The tape counter and the remaining tape length indicator appear only when a cassette is inserted. Also, the remaining tape length indicator appears after any tape operation.

EASY INFORMATION

If Extended Data Service (XDS) signals are provided along with the normal TV signal in your area or during playback of a tape recorded with XDS signals, the station ID, program title, and program details are shown on the TV screen.

When viewing a channel with XDS signals, press **ENTER** and the station ID will appear on the TV screen. Press **ENTER** again and the program details will appear on the TV screen.

When viewing a tape recorded with XDS signals, press **ENTER** twice and the program title and program details will appear on the TV screen.

PROGRAM DETAILS

LENGTH: Indicates the run length of a program.

TIME REMAINING: Indicates the remaining time of a program.

RATING: Indicates the rating of the current program (N/A, G, PG, PG-13, R, NC-17, X and Not Rated). The rating N/A means that the motion picture ratings are not applicable to this program.

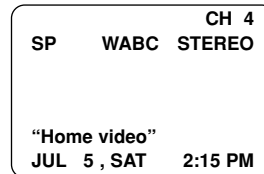

Easy Information Screen (Station ID)

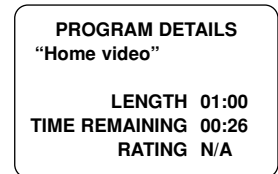

Easy Information Screen (Program details)

On-Screen Menus Setup

The DVD+VCR on-screen menu system provides convenient access to Clock, Program, Tuning, and Setup options.

Menu Selection

Your VCR allows remote control adjustment of several features.

1 Press **MENU** to display the **MAIN** menu.

2 Select the desired menu with the **▲/▼** buttons and then press **ENTER**.

Note

Menus remain on-screen for 3 minutes.

MAIN MENU

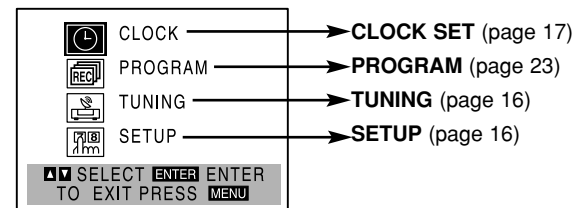

3 Press **MENU** when finished.

VCR Operation Setup (Continued)

VCR Setup Menu Options

- 1 Press **MENU** to display the **MAIN** menu.
- 2 Use **▲/▼** to select the **SETUP** menu, then press **ENTER**.
The **SETUP** menu will appear.

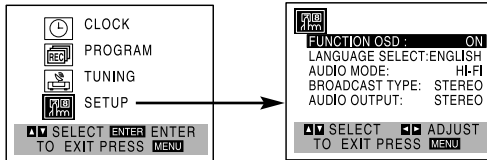

- 3 Use **▲/▼** to choose the desired option on the **SETUP** menu, then use **◀/▶** to choose the desired setting.

FUNCTION OSD

The DVD+VCR on-screen displays can be turned on or off.

- Press **◀/▶** to set **FUNCTION OSD** to **ON** or **OFF**.

LANGUAGE SELECT

The DVD+VCR on-screen menus can be displayed in English, Spanish, or French.

- Press **◀/▶** to set **LANGUAGE SELECT** to **ENGLISH**, **SPANISH** or **FRENCH**.

AUDIO MODE

The DVD+VCR has two separate audio playback systems: 1) High-quality VHS Hi-Fi system, and 2) NORMAL mono system. The same audio is generally recorded on both systems. The VHS Hi-Fi system plays on separate (left and right) channels, and the NORMAL system plays monaural sound. The normal track is always played so the cassette can be played on a DVD+VCR that does not have VHS Hi-Fi.

- Press **◀/▶** to set **AUDIO MODE** to **HI-FI** or **NORMAL**.

BROADCAST TYPE (STEREO/SAP/MONO)

Multichannel Television Sound (MTS) carries stereo and/or Second Audio Program (SAP) bilingual signals. Set this display to the desired position when both MTS stereo and SAP signals are received. When only one of the MTS signals is received, the DVD+VCR automatically selects the corresponding receiving mode (Stereo or SAP) regardless of the selected position. For normal operation, the display should be in the **STEREO** position. The DVD+VCR will then record a **STEREO** program when available, and record a **mono** program IF the program is **NOT IN STEREO**. For weak **STEREO** and/or **SAP** broadcasts, changing the display to **mono** may give clearer sound.

- Press **◀/▶** to set **BROADCAST TYPE** to **STEREO**, **SAP**, or **MONO**.

AUDIO OUTPUT (STEREO/LEFT/RIGHT)

Used during playback [when **AUDIO MODE** (**HI-FI**/**NORMAL**) is in **HI-FI** position] for selecting the audio output signals from the **AUDIO OUT** terminals (**L ch** and **R ch**), and **RF.OUT**.

This display setting should normally be left in the **stereo** position, so that when a stereo tape is played, the stereo sound will be heard through the left and right channels. If a mono tape is played and the audio output is set to **stereo**, the same mono sound will be heard from both left and right channels.

- Press **◀/▶** to set **AUDIO OUTPUT** to **STEREO**, **LEFT**, or **RIGHT**.

- 4 Press **MENU** when finished.

Channel Selection

This DVD+VCR is equipped with a frequency synthesized tuner capable of receiving up to 181 channels. These include VHF channels 2-13, UHF channels 14-69 and CATV channels 1-125.

Preparation:

- Connect the DVD+VCR to the desired type of antenna or cable TV system, as shown in "Connecting Antenna/Cable TV to DVD+VCR" on page 11.

AUTO CHANNEL PROGRAMMING

- 1 Press **MENU** to display the **MAIN** menu.
- 2 Use **▲/▼** to select the **TUNING** menu, then press **ENTER**.
The **TUNING** menu will appear.

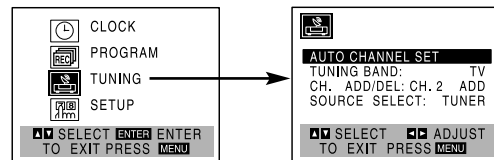

- 3 Press **▼** to choose the **SOURCE SELECT** option, then use **◀/▶** to select **TUNER**.
Press **◀/▶** repeatedly to select **TUNER**, **LINE1** or **LINE2**.
- 4 Use **▲/▼** to choose the **AUTO CHANNEL SET** option, then use **◀/▶** to search for channels.
The tuner will automatically scan for all available channels in your area and place them in the tuner's memory.
- 5 When **AUTO CHANNEL SET** is complete, make sure **TUNING BAND** is set appropriately (**TV** or **CATV**) in the **TUNING** menu.
Remember, **TV** is for over-the-air antenna reception, and **CATV** is for cable or wireless connection.
- 6 Press **MENU** to return to the **TV** screen.
- 7 Use **CH/TRK (▲/▼)** or **CH (▲/▼)** on the front panel to cycle the DVD+VCR through the channels in memory.

TO ADD OR ERASE CHANNELS FROM MEMORY

This feature allows you to add or erase channels in memory manually.

- 1 Use **▼** to choose the **CH. ADD/DEL** option on the **TUNING** menu. Use **◀/▶** to select a channel to add or erase.
- 2 Use **ENTER** to add or erase the channel.
Repeat steps 1 and 2 to add or erase channels.
- 3 Press **MENU** to return to the **TV** screen.

VCR Operation Setup (Continued)

Setting the Clock

The DVD+VCR gives you two ways to set the time and date: 1) Auto Clock Set, or 2) Manual Clock Set. The Auto Clock Set feature enables the DVD+VCR to set the clock while the DVD+VCR is turned off.

Things to know before starting

- The clock uses the 12-hour system. Be sure to set AM and PM correctly (AM does not appear on the front panel display). The initial Clock Setting is **JANUARY 1, 2003, 12:00 AM**.

Auto Clock Set

The Auto Clock Set feature is set to ON at the factory. In the ON setting, the DVD+VCR searches for a channel carrying XDS (Extended Data Services) information. The Auto Clock feature enables the DVD+VCR to set the clock while the DVD+VCR is turned off.

- 1 Press **MENU** to display the **MAIN** menu.
- 2 Use **▲/▼** to choose the **CLOCK** menu.
Press **ENTER** and the **CLOCK** menu will appear.

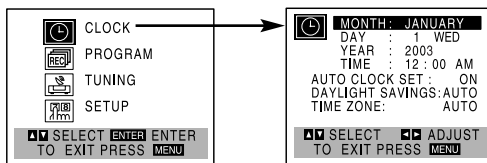

- 3 Use **▼** to choose the **AUTO CLOCK SET** option.
Use **◀/▶** to choose **ON**.
The Auto Clock Set feature is set to ON at the factory. In the ON setting, the DVD+VCR looks for a channel carrying XDS (Extended Data Services) information. XDS updates the clock using the Coordinated Universal Time.
- 4 Use **▼** to choose the **DAYLIGHT SAVINGS** option.
Use **◀** or **▶** to choose **AUTO, ON, or OFF**.
If you choose AUTO, the VCR sets the clock using the DST information broadcast in the signal (channel).
If you choose ON, the VCR adjusts the clock for Daylight Saving Time automatically.
- 5 Use **▼** to choose the **TIME ZONE** option.
Use **◀** or **▶** to choose the correct time zone (**AUTO, EASTERN, CENTRAL, MOUNTAIN, PACIFIC, ALASKA or HAWAII**).
If "AUTO" is selected as the time zone, the VCR sets the clock using the first Coordinated Universal Time information it finds in a broadcast signal.
- 6 Press **MENU** when finished.
- 7 Turn off the DVD+VCR and the auto clock set feature sets the time.

Note

There are cases where the TV station does not send or sends wrong date and/or time information and the DVD+VCR sets the incorrect time.

If this happens we recommend that you set the clock manually.

Manual Clock Set

- 1 Press **MENU** to display the **MAIN** menu.
- 2 Use **▲/▼** to choose the **CLOCK** menu.
Press **ENTER** and the **CLOCK** menu will appear.

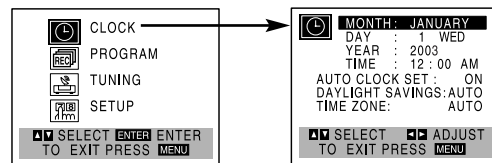

- 3 Use **◀/▶** to choose the **MONTH** option.
- 4 Use **▼** to choose the **DAY** option.
Use **◀/▶** to choose the date.
The day of the week will display automatically.
- 5 Use **▼** to choose the **YEAR** option.
Use **◀/▶** to choose the year.
- 6 Use **▼** to choose the **TIME** option.
Use **◀/▶** to choose the time.
Press and hold **◀/▶** to advance the clock continuously.
- 7 Use **▼** to choose the **DAYLIGHT SAVINGS** option.
Use **◀** or **▶** to choose **AUTO, ON, or OFF**.
If you choose AUTO, the VCR sets the clock using the DST information broadcast in the signal (channel).
If you choose ON, the VCR adjusts the clock for Daylight Saving Time automatically.

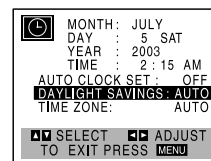

- 8 Press **MENU** when finished.

Note

If setting the clock manually, "AUTO CLOCK SET" must be set to "OFF". If it is set to "ON", an incorrect date and/or time will be entered again when the DVD+VCR is turned off.

DVD Operation Setup

General Explanation

This manual provides general instructions for operating the DVD+VCR. Some DVDs have special requirements or allow only limited operations during playback. When this occurs, the  symbol appears on the TV screen, indicating that the operation is not permitted by the DVD+VCR or is not available on the disc.







On-Screen Display

The On-Screen Display gives feedback on the status of the DVD+VCR, and provides a shortcut to change various playback options.

On-screen display operation

- 1** Press **DISPLAY** during playback.
- 2** Use **▲/▼** to select an option.
The selected option will be highlighted.
- 3** Use **◀/▶** to change the setting of an option.
The number buttons can be also be used for setting numbers (e.g., title number). For some functions, press **ENTER** to execute the setting.







Temporary Feedback Field Icons

-  Repeat Title (DVD)
-  Repeat Chapter (DVD)
-  Repeat A-B
-  Repeat Off
-  Resume play from this point
-  Action prohibited or not available

Notes

- Some discs may not provide all the features in the example below.
- If no button is pressed for 10 seconds, the on-screen display disappears.

DVD

Options		Function (Use ▲/▼ to select the desired option)	Selection Method
Title Number	 1/3	Shows the current Title number and total number of Titles, and skips to the desired title number.	◀/▶, or Numeric, ENTER
Chapter Number	 1/12	Shows the current Chapter number and total number of Chapters, and skips to the desired Chapter number.	◀/▶, or Numeric, ENTER
Time search	 0:16:57	Shows the elapsed playing Time, and searches for a specific elapsed time.	Numeric, ENTER
Audio Language and Digital Audio Output mode	 1 ENG D D D 5.1CH	Shows the current Audio soundtrack language, encoding method, and channel number, and changes the setting.	◀/▶, AUDIO
Subtitle Language	 OFF	Shows the current Subtitle language, and changes the setting.	◀/▶, SUBTITLE
Angle	 1/1	Shows the current Angle number and total number of Angles, and changes the Angle number.	◀/▶, ANGLE
Sound	 NORM.	Shows the current Sound mode, and changes the setting.	◀/▶

DVD Operation Setup (Continued)

Initial Settings

You can set your personal preferences for DVD+VCR operation.

General Operation

- 1 Press SETUP.**
The setup menu appears.



- 2 Use ▲/▼ to select the desired option.**
The screen will show the current setting for the selected option, as well as alternate setting(s).
- 3 While the desired option is selected, press ►, then use ▲/▼ to select the desired setting.**
- 4 Press ENTER to confirm your selection.**
Some options require additional steps.
- 5 Press SETUP, RETURN, or PLAY (►) to exit the setup menu.**

Language

Disc Language **DVD**

Select your preferred language for Disc Menus, Audio soundtracks, and Subtitles.

Original: The original language set for the disc is selected.

Other: To select another language, use the number buttons to enter the corresponding 4-digit number according to the language code list on page 38. If you enter the wrong language code, press CLEAR.

Note

Disc language selections may not be available on some DVDs.



Menu Language

Select a language for the DVD Setup menu. This is the menu you see when you press SETUP in DVD mode.

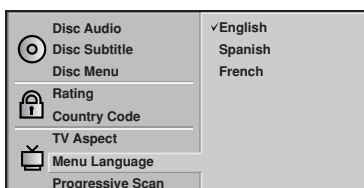

Picture

TV Aspect **DVD**

4:3 Letterbox: Select when a standard 4:3 TV is connected. Displays theatrical images with masking bars above and below the picture.

4:3 Panscan: Select when a standard 4:3 TV is connected. Displays pictures cropped to fill your TV screen. Both sides of the picture are cut off.

16:9 Wide: Select when a 16:9 wide TV is connected.

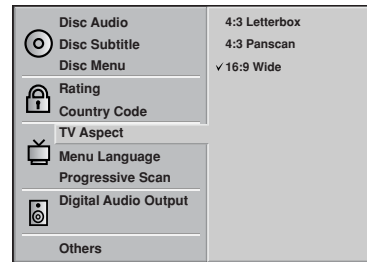

Progressive Scan **DVD**

Progressive Scan video provides the highest resolution picture with less flicker and greater line clarity. If you are using the COMPONENT/PROGRESSIVE SCAN VIDEO OUT jacks, but are connecting the DVD+VCR to a standard (analog) television, set Progressive Scan to Off.

If you are using the Component Video jacks for connection to a TV or monitor that is compatible with a Progressive Scan signal, set Progressive Scan to On.



Notes

- Progressive Scan is available only when the VIDEO OUTPUT switch on the rear panel is set to COMPONENT.

Caution

Once the setting for Progressive Scan output is entered, an image will only be visible on a Progressive Scan compatible TV or monitor. If you set Progressive Scan to On in error, you must reset the unit. Pointing the remote at the player, press the STOP (■) button to stop any disc that is playing. Next, press the STOP (■) button again and hold it for five seconds before releasing it. The video output will be restored to the standard setting, and a picture will once again be visible on a conventional analog TV or monitor.

DVD Operation Setup (Continued)

Sound

Digital Audio Output

Each DVD disc has a variety of audio output options. Set the DVD+VCR's Digital Audio Output according to the type of audio system you use.

DOLBY DIGITAL/PCM: Select DOLBY DIGITAL/PCM if you have connected the DVD+VCR's DIGITAL AUDIO OUT jack to a Dolby Digital decoder (or an amplifier or other equipment with a Dolby Digital decoder).

Stream/PCM: Select Stream/PCM if you have connected the DVD+VCR's DIGITAL AUDIO OUT jack to an amplifier or other equipment with a DTS decoder, Dolby Digital decoder or MPEG decoder.

PCM: Select when connected to a 2-channel digital stereo amplifier. The DVD+VCR outputs sounds in the PCM 2-channel format when you play a DVD video disc recorded with a Dolby Digital, MPEG1, or MPEG2 recording system.

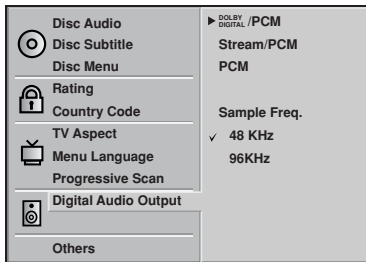

Sample Frequency

To change the Sample Frequency setting, first select the desired Digital Audio Output as indicated above. If your receiver or amplifier is NOT capable of handling 96KHz signals, select 48KHz. When this choice is made, the unit will automatically convert any 96KHz signals to 48KHz so your system can decode them. If your receiver or amplifier is capable of handling 96KHz signals, select 96KHz. When this choice is made, the unit will pass each type of signal through without any further processing.

Others

The Dynamic Range Control (DRC) and Vocal settings can also be changed.

- Use ▲/▼ to select the desired option and then press ENTER repeatedly to select On or Off.

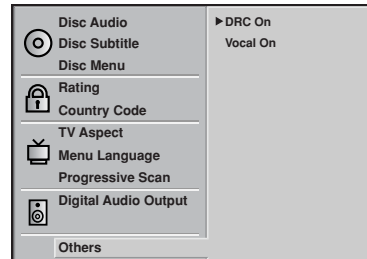

Dynamic Range Control (DRC)

With the DVD format, you can hear a program's soundtrack in the most accurate and realistic presentation possible, thanks to digital audio technology. However, you may wish to compress the dynamic range of the audio output (the difference between the loudest and quietest scenes), e.g., when watching a movie late at night. With DRC set to ON, you can listen to a movie at a lower volume without losing sound clarity.

Vocal

Set Vocal to On only when a multi-channel karaoke DVD is playing. The karaoke channels on the disc will mix into normal stereo sound.

DVD Operation Setup (Continued)

Parental Control

Rating **DVD**

Movies on DVDs may contain scenes not suitable for children. Therefore, discs may contain Parental Control information that applies to the complete disc or to certain scenes on the disc. These scenes are rated from 1 to 8, and alternatively, more suitable scenes are available for selection on some discs. Ratings are country-dependent. The Parental Control feature allows you to prevent discs from being played by your children or to have certain discs played with alternate scenes.

Disc Audio	8
Disc Subtitle	7
Disc Menu	6
Rating	5
Country Code	4
TV Aspect	3
Menu Language	2
Progressive Scan	1
Digital Audio Output	►Unlock Change
Others	

1 Select **Rating** on the Setup menu using the ▲/▼ buttons.

2 While **Rating** is selected, press ►.

3 If you have not yet entered a password:
Enter a 4-digit security password using the number buttons, then press ENTER. Enter the 4-digit password again and press ENTER to verify.

If you have already entered a password:
Enter your 4-digit security password using the number buttons, then press ENTER.

If you make a mistake before pressing ENTER, press CLEAR and enter your 4-digit security password again.

4 Select a rating from 1 to 8 using the ▲/▼ buttons. **One (1) has the least playback restrictions. Eight (8) has the most playback restrictions.**

Unlock: If you select **Unlock**, Parental Control is not active. The disc will play in full.

Ratings 1 to 8: Some discs contain scenes not suitable for children. If you set a rating for the DVD+VCR, all disc scenes with the same rating or lower will be played. Higher rated scenes will not be played unless an alternate scene is available on the disc. The alternate must have the same rating or a lower one. If no suitable alternate scene is available, playback will stop. You must enter the 4-digit password or change the rating level in order to play the disc.

5 Press ENTER to confirm your rating selection, then press SETUP to exit the menu.

Country Code **DVD**

Enter the code of the country whose standards were used to rate the DVD video disc, referring to the "Country Code List" on page 39.

Disc Audio	Code Set
Disc Subtitle	U S
Disc Menu	
Rating	
Country Code	
TV Aspect	
Menu Language	
Progressive Scan	
Digital Audio Output	
Others	

1 Select the **Country Code** option using the ▲/▼ buttons on the setup menu.

2 While **Country Code** is selected, press ►.

3 Follow step 3 under "Rating" at left.

4 Select the first character using the ▲/▼ buttons.

5 Press ► to shift to the second character and select it using the ▲/▼ buttons.

6 Press ENTER to confirm your Country Code selection, then press SETUP to exit the menu.

Note

Confirmation of the 4-digit password is necessary when the password is changed (see "Changing the 4-digit password" below).

Changing the 4-digit password

- 1 Follow Steps 1-2 as shown above under "Rating" at left.
- 2 Enter the old password, then press ENTER.
- 3 Select Change using the ▲/▼ buttons then press ENTER.
- 4 Enter the new 4-digit password, then press ENTER.
- 5 Enter exactly the same password a second time and verify by pressing ENTER.
- 6 Press SETUP to exit the menu.

If you forget your 4-digit password

If you forget your password, you can clear the current password by following the procedure below.

- 1 Press SETUP to display the Setup menu.
- 2 Enter the 6-digit number 210499 and then press ENTER.
The 4-digit password is cleared.
- 3 Enter a new password as shown under "Rating" at left.

VCR Operation

Normal Playback

Preparation:

- Turn on the TV.
- Tune the TV to the DVD+VCR output channel (CH 3 or 4) or set the TV's source selector to VIDEO.
- If a direct VIDEO/AUDIO connection is made between the DVD+VCR and the TV, set the TV's source selector to VIDEO.
- Set the DVD+VCR source to VCR as shown in "Selecting the Viewing Source" on page 6.

1 Insert a prerecorded video cassette.

The  indicator will light and the DVD+VCR will power-up automatically.

- Make sure that the  indicator in the display window is not lighted. If it is, press **POWER** once.
- If a tape without a record safety tab is inserted, the unit will start playback automatically.

2 Press **PLAY** () once.

PLAY appears on the TV screen .

- It is not necessary to select the tape speed for playback. It will be automatically selected by the DVD+VCR.
- During playback, the **TV/VCR** selector switches to VCR mode automatically.

3 Press **STOP** () to stop playback.

STOP appears on the TV screen.

- If the tape reaches the end before **STOP** () is pressed, the DVD+VCR will automatically stop, rewind, eject the tape, and power off.





Tracking Control

Auto Tracking

The automatic tracking function adjusts the picture to remove snow or streaks during playback. The AUTO TRACKING function works in the following cases:

- When a tape is played back for the first time.
- When the tape speed (SP, LP, EP) changes.
- When streaks or snow appear due to scratches on the tape.

Manual Tracking

If noise appears on the screen during playback, press either **CH/TRK** / on the remote control or **CH** (/) on the front panel until the noise on the screen is reduced.

- If vertical jitter is present, adjust tracking controls very carefully.
- Tracking is automatically reset to normal when the tape is ejected or the power cord is unplugged for more than 3 seconds.

Special Effects Playback

Special effects playback notes

- Horizontal lines (noise bars) will appear on the TV screen. This is normal.
- The audio is automatically muted during special effects, so there is no sound during search.
- During high-speed picture search, a short period is needed to stabilize tape speed when re-entering Play mode. Slight interference may be observed during this period.

Search

The Search function allows you to visually scan forward or backward during playback.



1 Press **REW** () or **FF** () during playback to activate Search mode.

- If the DVD+VCR is left in Search mode for more than 3 minutes, the DVD+VCR will automatically enter Play mode to protect the tape and video heads.

2 To return to normal playback, press **PLAY** () .

Still Picture and Frame-by-Frame Playback

1 Press **PAUSE/STEP** () during playback to pause the picture on the TV screen.

- If a still picture vibrates vertically, stabilize it using / on the remote control.
- If the DVD+VCR is left in Still mode for more than 5 minutes, the DVD+VCR will automatically enter Stop mode to protect the tape and video heads.



2 Press **PAUSE/STEP** () repeatedly to advance the video picture one frame at a time.

3 To return to normal playback, press **PLAY** () .

Slow Motion

1 While in Still mode, press **FF** () .

The tape will be played back in slow motion (1/19 normal speed).

- During slow motion playback, use / on the remote control to minimize noise bands.
- If slow motion playback continues for more than 3 minutes, the DVD+VCR will automatically change to normal Play mode.

2 To return to normal playback, press **PLAY** () .

Commercial Skip

This feature is useful for skipping commercials or short program segments.

1 Press **SKIP** during playback.

The tape will fast forward picture search through 30 seconds of recording.

- Skipping time can be extended by pressing **SKIP** repeatedly.
- Subsequent presses result in advancing the fast forward picture search time in 30-second increments (up to a maximum of 3 minutes).

2 When the search is complete, the DVD+VCR will return to normal playback mode automatically.

VCR Operation (Continued)

Normal Recording

Preparation:

- Turn on the power on both the DVD+VCR and TV.
- Tune the TV to the DVD+VCR output channel (CH 3 or 4) or set the TV's source selector to VIDEO.
- If a direct VIDEO/AUDIO connection is made between the DVD+VCR and the TV, set the TV's source selector to VIDEO.

1 Insert a video cassette with the record safety tab intact.

2 Select the desired channel with ▲▼.

- If you are recording from an external source via the audio/video input jacks (on the Rear or Front panel), select LINE1 or LINE2 by pressing the INPUT button.

3 Set the desired recording speed (SP or EP) with the SP/EP button.

- This DVD+VCR is not designed to record in LP mode.

4 Set the MTS mode as desired (see pages 16, 26).

5 Press REC (●) once.

Recording will start. (The REC indicator will light on the front panel display.)

- The REC indicator appears only when the output source is set to VCR.
- If a cassette with no record safety tab is loaded, the cassette will be ejected automatically.

6 Press STOP (■) to stop recording.

If the tape reaches the end before STOP (■) is pressed, the DVD+VCR will automatically stop, rewind, eject the tape, and power off.

To pause recording

1 Press PAUSE/STEP (||) to pause the tape during recording.

The REC indicator will flash on the front panel display.

2 When you want to continue recording, press PAUSE/STEP (||) or REC (●).

- After 5 minutes in Pause mode, the tape will be stopped automatically to protect the tape and the video heads.

To record one TV program while watching another

1 Use TV/VCR to select TV mode during recording. The TV indicator appears.

2 Using your TV's remote control, select the channel to be viewed.

Tips

For best results, always use PAUSE/STEP (||) when making changes during recording.

For example: To change channels during recording, first press PAUSE/STEP (||) to put the unit in Pause mode. Select the desired channel on the DVD+VCR, then press PAUSE/STEP (||) again to resume recording.

Timer Recording

The DVD+VCR can be programmed to record up to 8 programs within a period of 1 year. To set a timer recording, simply enter the channel to be recorded and the starting and ending times.

Things to know before starting

- If you try to set the program timer before setting the clock, PLEASE SET THE CLOCK appears for a moment and then the CLOCK menu appears on the TV screen. Set the time and date before proceeding.
- Make sure a tape is in the DVD+VCR and the record safety tab is in place or the tape will be automatically ejected.

Preparation:

- Turn on the power on both the DVD+VCR and the TV.
- Be sure the TV is set to the DVD+VCR output channel (3 or 4).
- Make sure the TUNING BAND in the TUNING menu is set appropriately (TV or CATV).

1 Press MENU to display the MAIN menu.

2 Use ▲▼ to choose the PROGRAM menu.

3 Press ENTER to go to the PROGRAM menu. The PROGRAM menu will appear.

- If all 8 programs have been entered, the message FULLY PROGRAMMED will appear for a moment and then PROGRAM 1 will appear on the TV screen.

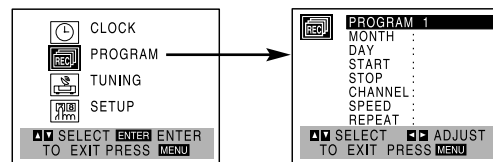

4 Use ◀▶ to choose the PROGRAM No. (1-8).

5 Use ▼ to choose the MONTH option.

Use ◀▶ to choose the desired month.

6 Use ▼ to choose the DAY option.

Use ◀▶ to choose the desired day.

7 Use ▼ to choose the START option.

Use ◀▶ to choose the desired start time.

8 Use ▼ to choose the STOP option.

Use ◀▶ to choose the desired stop time.

9 Use ▼ to choose the CHANNEL option.

Use ◀▶ to choose the desired channel (Channel, LINE1 or LINE2).

Cable Users: If you have CABLE TV and used Cable Box in Connecting Antenna/Cable TV to DVD+VCR (page 11), using a cable box converter, you must set the channel in this step to match the cable box output channel (usually CH 3 or 4). Change channels on the cable box instead of on the DVD+VCR.

VCR Operation (Continued)

- 10** Use **▼** to choose the **SPEED** option.
Use **◀▶** to choose the desired recording speed (**AUTO**, **SP** or **EP**).
- **AUTO** mode determines how much tape is left and automatically switches from **SP** to **EP**, if necessary, to complete recording of the program. There will be some picture and sound distortion at the point of the speed change.

- 11** Use **▼** to choose the **REPEAT** option.
Use **◀▶** to choose the desired repeat (**ONCE**, **WEEKLY** or **DAILY**).
- ONCE event....**for recording a single event.
WEEKLY event....for recording an event on a certain day every week.
DAILY event....for recording an event at the same time Monday through Friday.

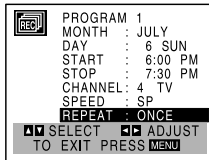

Tip
If the input data is wrong, use **▲** to select the data and correct it using **◀▶**.

12 Press **MENU**. The program will be memorized by the DVD+VCR.

- The  indicator lights on the front panel display.
- If the program time has past, the **PAST TIME PROGRAMMED** message will appear on the TV screen. Return to the incorrect program and program it with the correct time.
- If you have entered a past date, the timer recording will be performed on that date of the next year.
- Additional programs may be entered by repeating steps **1-12**.

Cable Users: If your cable hookup is via a TV converter box, you can program multiple recordings only on the converter box output channel. This is because the converter determines what channel you view through your DVD+VCR.



Tip
If you are finished programming and you want to set the DVD+VCR to record the programs you have entered, **MAKE SURE YOU HAVE INSERTED A TAPE INTO THE DVD+VCR**. The DVD+VCR is now set to record the preset programs.

Notes

If the power fails or the DVD+VCR is unplugged from the AC outlet, the correct clock time and timer settings are kept in memory for approximately 3 seconds. After 3 seconds, the clock and program timer must be reset when power is restored. Reset the clock according to the instructions.

After setting up a timer recording, recording will start if no other timer recordings are scheduled to occur at the same time (see "Program Priority" at right).

Checking (Erasing) Timer Record Programming

Programming can be checked whenever the DVD+VCR is turned on.

- 1 Press **MENU** to display the **MAIN** menu.
- 2 Use **▲▼** to choose the **PROGRAM** menu.
Press **ENTER** and the **PROGRAM** menu will appear.

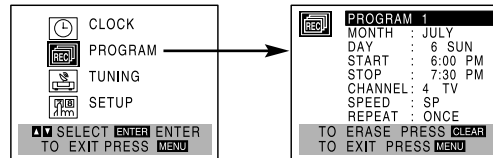

- 3 Use **◀▶** to select a program you want to check or erase. If you want to erase the program, press **CLEAR**.
- 4 Press **MENU** to return to the TV screen.

Program Priority

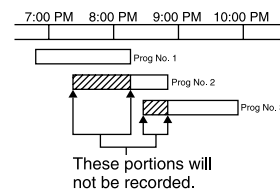

If the starting and ending times of two or more timer recordings overlap on the same day, priority is given to the earliest recording. For example, in the diagram at left Program number 2 will not be recorded until

Program number 1 is finished. The first part of Program number 2 will not be recorded. Likewise, Program number 3 will not be recorded until Program number 2 is finished, and so on.

VCR Operation (Continued)

Instant Timer Recording

Instant Timer Recording allows you to easily make a recording of a preset length without using the programmable timer.

Preparation:

- Turn on the power on both the DVD+VCR and the TV.
- Be sure the TV is tuned to the DVD+VCR output channel (3 or 4).
- If a direct VIDEO/AUDIO connection is made between the DVD+VCR and the TV, set the TV's source selector to VIDEO.

- 1 Insert a video cassette with the record safety tab intact.**
- 2 Select the desired channel with ▲/▼ or the number (0-9) buttons.**

The channel number appears on the TV screen.

 - If you are recording from another source via the audio/video input jacks (on the Rear or Front panel), select LINE1 or LINE2.
- 3 Select the desired recording speed (SP or EP) with the SP/EP button.**

The tape speed will appear on the TV screen.
- 4 Press REC (●) twice.**

The "Instant Timer Record" will appear on the TV screen.

 - Recording will start. (The Ⓛ indicator will light)
- 5 Press REC (●) repeatedly to select the recording time length.**

At the end of the recording, the DVD+VCR will stop recording and shut off.

 - During Instant Timer Recording, you cannot change the channel on the DVD+VCR.
 - You can stop the recording by pressing STOP (■).

INSTANT TIMER RECORD MENU

INSTANT TIMER RECORD	
CHANNEL	2
SPEED	SP
START LENGTH	NOW 0H30M

0H30M 9H00M → 0H00M
↑
Length Display
(each additional press of
REC (●) increases recording
time 30 minutes)

Checking the Recording Time

Press REC (●) once to check the recording time. The DVD+VCR will display the time on screen for ~6 seconds and then return to the recording in progress.

To Extend the Recording Time

Recording time can be extended anytime by pressing REC (●).

Subsequent presses result in increasing the recording time in 30-minute increments.

Notes

- If you press PAUSE/STEP (||) during instant timer recording, the DVD+VCR will enter Record/Pause mode. Instant Timer Recording is cancelled.
- If the DVD+VCR is set to "0H00M", the DVD+VCR goes to normal Recording mode.

Dubbing and Editing

You can easily edit or dub camcorder/VCR recordings to the DVD+VCR via the front/rear panel audio/video jacks. These direct A/V jacks provide better picture results than using the RF jack on the rear panel.

- 1 Connect the camcorder (or secondary VCR) to the A/V inputs of the DVD+VCR as shown on page 14.**
- 2 Set the input channel to "LINE2". (Press INPUT to select LINE2.)**
 - If you have connected your DVD+VCR to the A/V input jacks on the rear of the DVD+VCR, you should select LINE1 by pressing INPUT twice.
- 3 Play the tape in the camcorder (or another VCR). If you have a TV attached to your DVD+VCR, you can see the video playing.**
- 4 When you are ready to begin recording, press REC (●) once to start.**

Note

Before recording, please confirm the recording start position.

Copying from DVD to VCR

This unit is capable of copying the contents of a DVD to a VHS tape.

Note

If the DVD you are attempting to copy is copy protected, you will not be able to copy the disc. It is not permitted to copy Macrovision-encoded DVDs. "Lock" is displayed on the front panel display.

- 1 Insert Disc**

Insert the disc you wish to copy in the DVD deck and close the disc tray.
- 2 Insert VHS Tape**

Insert a blank VHS video tape into the VCR deck.
- 3 Press PLAY (▶) on the DVD deck.**

The DVD will go into Play mode

 - If the DVD disc menu appears, you may need to press PLAY (▶) manually to begin copying.
- 4 Press COPY on the front panel.**
 - The DVD+VCR will go into Record mode.
 - The "COPY" indicator will light.

5 Stop the Copy Process

When the DVD is finished playing, press the VCR button on the remote control and then press STOP (■) to stop recording.

You must stop the Copy process manually when the DVD movie ends, or the unit may replay and record over and over again.

Note

When you stop DVD playback during copying, the VCR Recording mode also stops automatically.

VCR Operation (Continued)

VHS Hi-Fi Stereo System/ MTS Broadcast

The DVD+VCR is equipped with a VHS Hi-Fi audio sound system for recording and playback. The information below gives a brief description of Hi-Fi audio and how to record and play tapes in Hi-Fi audio mode.

Playback with Hi-Fi Stereo Audio Sound

A stereo TV with AUDIO/VIDEO input jacks or a stereo audio system is required for true stereo playback. To experience the full and rich stereo sound available with Hi-Fi recorded tapes, we recommend the connection of this unit to a home stereo audio system.

1 Set AUDIO MODE to HI-FI in the SETUP menu .

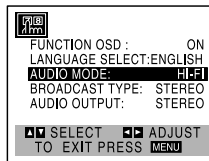

2 Set AUDIO OUTPUT to STEREO.

STEREO: The left channel sound (L) is heard from the left speaker and the right channel sound (R) is heard from the right speaker.

LEFT: The left channel sound (L) is heard from both speakers.

RIGHT: The right channel sound (R) is heard from both speakers.

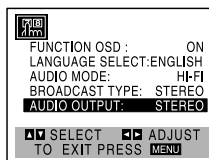

3 Press MENU.

4 Insert a cassette and press PLAY (▶). Adjust the volume on your stereo system.

MTS (Multi-Channel TV Sound)

The DVD+VCR will decode MTS stereo and bilingual (SAP) off-the-air broadcast sound signals. It also decodes stereo TV sound from local cable companies, as long as they operate on assigned cable frequencies and use the EIA-recommended MTS stereo/bilingual TV sound system.

Multichannel TV Sound Indicator (MTS)

MTS information is shown on screen when **ENTER** is pressed.

- One or both of the indicators will light, depending on the MTS broadcast.

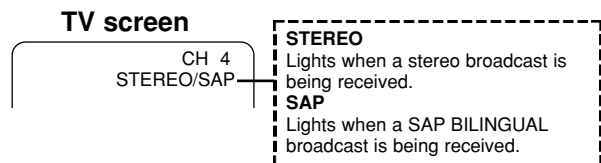

If only STEREO appears on the TV screen:

The DVD+VCR can record in stereo onto the VHS Hi-Fi audio tracks when the BROADCAST TYPE option is set to STEREO. The DVD+VCR will also record mono audio onto the mono audio track.

If only SAP appears on the TV screen:

Set the BROADCAST TYPE option to SAP.

If STEREO/SAP appears on the TV screen:

Use the BROADCAST TYPE option to select the desired Recording mode (STEREO or SAP).

SAP (Second Audio Program) Recording

Some stations transmit a Second Audio Program, which is used for a second language or additional information. When the station broadcasts a Second Audio Program, follow the procedure below to record the SAP.

1 Insert a video cassette with the record safety tab intact.

2 Set BROADCAST TYPE to SAP in the SETUP menu.

Do this only if SAP appears on the TV screen or you know the program will use SAP.

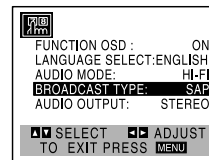

3 Press MENU.

4 Select the desired recording speed (SP or EP) with the SP/EP button.

5 Select the desired channel. SAP should appear on the TV screen.

6 Press REC (●) once

You are now recording the program you see and hear on the TV.

7 Press STOP (■) to stop recording.

VCR Operation (Continued)

Tape Counter Memory Feature

Real-Time Counter

The tape counter shows length of tape in hours, minutes, and seconds. Press **CLK/CTR** to select the real-time counter display.

Every press of **CLK/CTR** changes the TV screen as shown below.

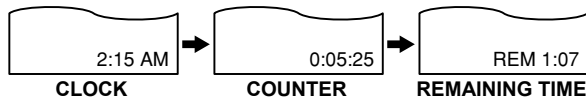

- The counter changes to “0:00:00” when the cassette is ejected.
- The real-time counter does not operate if nothing is recorded on the tape.
- The real-time counter will not work unless a tape is inserted.

Counter Memory Feature

This is useful if there is a section of tape you want to view immediately after recording or if you want to return to the same point several times.

- 1** Begin recording or playing a tape.
- 2** Press **CLK/CTR** repeatedly to display the real-time counter on the TV screen.
- 3** At the point you want to locate later, reset the real-time counter to “0:00:00” by pressing **CLEAR**.
- 4** Continue to play or record.
- 5** Press **STOP** (■) when recording or playback finishes.
- 6** Press **REW** (⏮).
The tape automatically stops when the tape counter returns to “0:00:00”.

Tape Remaining

This function shows the time remaining on the tape during recording or playback.

Press **CLK/CTR** repeatedly until the **REM** indicator appears on the TV screen during recording or playback.

Note

The remaining tape length indicator may not be displayed correctly depending on the condition of the tape and the kind of the tape (T-140, T-160, T-210, etc.)

Additional Information

- During Recording, Timer Recording, Instant Timer Recording, Play, or Fast Forward modes, the DVD+VCR automatically starts rewinding the tape at the end of the tape. The cassette will stop at the beginning of the tape and be ejected, and the DVD+VCR will turn itself off.
- After you have finished using the DVD+VCR, rewind, eject, and remove the cassette. Place the cassette in its protective sleeve to protect it from dust. It is not necessary to rewind the cassette before removing it, but if you do, it will be ready to play or record the next time you use it.
- Be sure the DVD+VCR Channel Selector is on the correct channel you wish to record. The channel that is being recorded can always be checked by tuning the television to the DVD+VCR channel (3 or 4) and pressing the **TV/VCR** selector to turn the DVD+VCR's TV indicator off.
- Do not attempt to hook up more than one television set to the DVD+VCR for either recording or playback.

Auto Play System

The DVD+VCR features automatic playback when you load a cassette with the record safety tab removed.

- The output source is changed to VCR mode automatically.
- The power turns on automatically and playback begins.
- At the end of the tape, the DVD+VCR stops and rewinds the tape.
- The cassette is ejected after rewinding and the VCR turns itself off automatically.

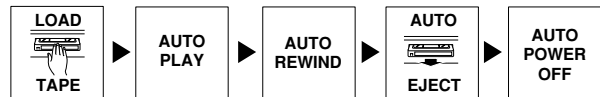

Note

Auto power off does not function during regular DVD Play mode. (The DVD+VCR power stays on.)

S-VHS Quasi Playback (SQPB)

- This DVD+VCR can play back S-VHS recorded tapes, however, it cannot make recordings using S-VHS format tapes.
- SQPB is an abbreviation for S-VHS Quasi Playback.

DVD Operation

Playing DVDs

Playback Setup **DVD**

- Turn on the TV and select the video input source connected to the DVD+VCR.
- Audio system: Turn on the audio system and select the input source connected to the DVD+VCR.
- Set the DVD+VCR output source to DVD as shown in "Selecting the Viewing Source" on page 6.

1 Press EJECT () to open the disc tray.

2 Load the disc in the tray with the label facing up.

When a double-sided DVD is inserted, make sure the side you want to play is facing down.

3 Press EJECT () to close the tray.





"LOAD" appears on the front panel display, and playback starts automatically. If playback does not start, press PLAY ().

In some cases, the disc menu may appear instead.

If a menu screen is displayed

If the DVD has a disc menu, it may be displayed when the disc is loaded.

DVD

Use the , , ,  buttons to select the title/chapter you want to view, then press ENTER to start playback.

Press TITLE or DISC MENU to return to the menu screen.

Notes

- If Parental Control is set and the disc is not within the Rating settings (not authorized), the 4-digit password must be entered and/or the disc must be authorized (see Parental Control, on page 21).
- DVDs may have a Region Code. Your DVD+VCR will not play discs that have a Region Code different from your DVD+VCR. The Region Code for this DVD+VCR is 1 (one).
- Do not keep a fixed image displayed on the screen for a long time.

Screen Saver



The screen saver picture appears when you leave the DVD+VCR in Stop mode for about five minutes.

General Features

Note

Unless otherwise stated, all operations described below use the remote control. Some features may also be available in the Setup menu.

Moving to another TITLE **DVD**







When a disc has more than one title, you can move to another title as follows:

- Press DISPLAY in Stop mode, then press the appropriate number buttons (0-9) and press ENTER to select the desired title number.















Moving to another CHAPTER



When a title on a disc has more than one chapter or a disc has more than one track, you can move to another chapter as follows:

- Press REW () or FF () briefly during playback to return to the beginning of the current chapter or to select the next chapter.
- Press REW () twice briefly to step back to the previous chapter.
- To go directly to any chapter during playback, press DISPLAY. Use   to select C (chapter). Then, enter the chapter number with the number buttons (0-9). Then, press ENTER.

Slow Motion **DVD**

- 1 Press PAUSE/STEP () during playback. The DVD+VCR will go into Pause mode.
- 2 Press REW () or FF () during Pause mode. The DVD+VCR will enter Slow mode.
- 3 Use REW () or FF () to select the desired speed:  1/16,  1/8,  1/4,  1/2 (backward), or  1/16,  1/8,  1/4,  1/2 (forward).
- 4 To return to normal playback, press PLAY ().

DVD Operation (Continued)

General Features (Continued)

Still Picture and Frame-by-Frame Playback

DVD

- 1 Press PAUSE/STEP (II) during playback. The DVD+VCR will go into Pause mode.
- 2 With a DVD, you can advance the picture frame by frame by pressing PAUSE/STEP (II) repeatedly on the remote control.
- 3 To return to normal playback, press PLAY (▶).

Search DVD

- 1 Press and hold REW (◀◀) or FF (▶▶) for about two seconds during playback. The DVD+VCR will go into SEARCH mode.
- 2 Press and hold REW (◀◀) or FF (▶▶) repeatedly to select the desired speed: ◀◀X2, ◀◀X4, ◀◀X16, ◀◀X100 (backward) or ▶▶X2, ▶▶X4, ▶▶X16, ▶▶X100 (forward).
- 3 To return to normal playback, press PLAY (▶).

Random Karaoke DVD

- 1 Press RANDOM during playback or Stop mode. The unit automatically begins Random Playback and "RANDOM" appears on the TV screen.
- 2 To return to normal playback, press RANDOM until "NORMAL" appears on the TV screen.

Tips

By pressing REW (◀◀) or FF (▶▶) during Random playback, the unit selects another title (track) and resumes Random playback.

Note

This function only works with DVD Karaoke discs.

Repeat DVD



DVD Video Discs - Repeat Chapter/Title/Off

- 1 To repeat the currently playing chapter, press REPEAT. The Repeat Chapter icon appears on the TV screen.
- 2 To repeat the title currently playing, press REPEAT a second time. The Repeat Title icon appears on the TV screen.
- 3 To exit Repeat mode, press REPEAT a third time. The Repeat Off icon appears on the TV screen.

Repeat A-B DVD



To repeat a sequence in a title:

- 1 Press A-B at your chosen start point. A- appears briefly on the TV screen.
- 2 Press A-B again at your chosen end point. A-B appears briefly on the TV screen, and the repeat sequence begins.
- 3 To cancel the sequence, press A-B again.

Time Search DVD



The Time Search function allows you to start playing at any chosen time on the disc.

- 1 Press DISPLAY during playback. The on-screen display appears on the screen. The Time Search box shows the elapsed playing time of the current disc.
- 2 Within 10 seconds, use ▲/▼ to select the Time Search icon in the on-screen display. The "--:--:--" appears in the Time Search box.
- 3 Within 10 seconds, use the number buttons to enter the desired start time. Enter hours, minutes and seconds from left to right in the box. If you enter the wrong numbers, press CLEAR to remove the numbers you entered. Then enter the correct numbers.
- 4 Within 10 seconds, press ENTER. Playback starts from the selected time on the disc. If you enter an invalid time, playback will continue from the current point.

3D Surround DVD



The DVD+VCR can produce a 3D Surround effect, which simulates multi-channel audio playback from two conventional stereo speakers (instead of the five or more speakers normally required to listen to multi-channel audio from a home theater system).

- 1 Press DISPLAY during playback.
- 2 Use ▲/▼ to select the Sound icon. The sound option will be highlighted.
- 3 Use ◀/▶ to select "3D SUR". To turn off the 3D Surround effect, select "NORM."

Zoom DVD

The Zoom function allows you to magnify the video image and move around the enlarged image.

- 1 Press ZOOM during playback or still playback to activate the Zoom function. If you press ZOOM repeatedly, the magnification level increases up to six steps.
- 2 Use the ◀/▶/▲/▼ buttons to move around the zoomed picture.
- 3 Press CLEAR to resume normal playback or return to the paused image.

Notes

- The Zoom function may not work on some DVDs.
- The Zoom function may not work on multi-angle scenes.

DVD Operation (Continued)

General Features (Continued)

Marker Search **DVD**



You can start playback from a bookmarked point on your disc. Up to nine points can be memorized. To enter a mark, follow these steps.

- 1 During disc playback, press MARK when playback reaches the point you want to bookmark. The Marker icon appears briefly on the TV screen.
- 2 Repeat step 1 to enter up to nine Marker points on a disc.

To Recall a Marked Scene

- 1 During disc playback, press SEARCH. The Marker Search menu will appear on the screen.
- 2 Within 10 seconds, use the ◀▶ or number buttons to select the Marker number you want to recall.
- 3 Press ENTER. Playback will start from the Marked scene.
- 4 To exit the MARKER SEARCH menu, press SEARCH.

To Clear a Marked Scene

- 1 During disc playback, press SEARCH. The Marker Search menu will appear on the screen.
 - 2 Within 10 seconds, use the ◀▶ or number buttons to select the Marker number you want to erase.
 - 3 Press CLEAR. The Marker number will be erased from the list.
 - 4 Repeat steps 2 and 3 to erase additional Marker numbers.
 - 5 To exit the MARKER SEARCH menu, press SEARCH.
- All markers are erased when the disc is ejected.

Changing Video Mode **DVD**

- With certain DVDs, the picture may flicker or “dot crawl” may be visible on straight lines. This may be due to the vertical interpolation or de-interlace not being perfectly matched with the disc. If so, the picture quality may be improved by changing the Video Mode.
- To change the Video Mode, press and hold DISPLAY for about 3 seconds during disc playback. The new Video Mode number selected is displayed on the TV screen. Check whether the video quality has improved. If not, repeat the above procedure until picture quality is improved.
- Video Mode change sequence:
MODE1 → MODE2 → MODE3 → MODE4 → MODE5 → MODE1, etc.
- If you turn off the power, the Video Mode will revert to MODE1.

Special DVD Features

Checking the contents of DVD Video discs: Menus

DVDs may contain menus that allow you to access special features. To use the disc menu, press DISC MENU. Then, press the appropriate number button to select the desired option. You can also use the ◀/▶/▲/▼ buttons to highlight your selection, then press ENTER.

Title Menu **DVD**

- 1 Press TITLE. If the current title has a menu, the menu will appear on the screen. Otherwise, the disc menu may appear.
- 2 The Title menu may list camera angles, audio languages, subtitle options, chapters, etc.
- 3 To remove the title menu, press TITLE again.

Disc Menu **DVD**

- 1 Press DISC MENU. The disc menu is displayed.
- 2 To exit the disc menu, press DISC MENU again.

Camera Angle **DVD**



If the disc contains sequences recorded from different camera angles, the angle icon blinks on the TV screen. You can then change the camera angle if you wish.

- Press ANGLE repeatedly during playback to select the desired angle. The number of the current angle appears on the display.

Changing the Audio Language **DVD**



Press AUDIO repeatedly during playback to hear a different audio language or audio track.

Subtitles **DVD**



Press SUBTITLE repeatedly during playback to see the different subtitle languages.

Note

If Ⓞ appears, the feature is not available on the disc.

Audio CD Operation

Playing an Audio CD

- 1 **Insert an Audio CD and close the tray.**
The Audio CD menu appears on the TV screen.

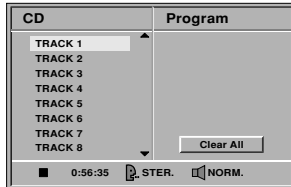

Audio CD Menu

- 2 Use ▲/▼ to select a track then press PLAY(▶) or ENTER to start playback.
During playback, the current track's elapsed playing time will appear on the front panel display. Playback will stop at the end of the disc.

- 3 To stop playback at any other time, press STOP(■).

Pause **CD**

- 1 Press PAUSE/STEP (⏸) during playback.
- 2 To return to normal playback, press PLAY (▶) or press PAUSE/STEP (⏸) again.



Moving to another Track **CD**

- Press REW (⏮) or FF (⏭) briefly during playback to go to the next track or to return to the beginning of the current track.
- Press REW (⏮) twice briefly to step back to the previous track.
- To jump directly to any track while listening to an audio CD, enter the track number using the number buttons (0-9).

Repeat Track/All/Off **CD**

- 1 To repeat the track currently playing, press REPEAT. The Repeat Track icon appears on the menu screen.
- 2 To repeat all tracks on a disc, press REPEAT a second time. The Repeat All icon appears on the menu screen.
- 3 To cancel Repeat mode, press REPEAT a third time. The Repeat Off icon appears on the menu screen.

Note

The REPEAT button is not available when the  mark appears. Press PROG. PLAY to remove the  mark.

Search **CD**

- 1 Press and hold REW (⏮) or FF (⏭) for about two seconds during playback. The player will go into Search mode.
- 2 Press and hold REW (⏮) or FF (⏭) repeatedly to select the desired speed: ⏮X2, ⏮X4, ⏮X8 (backward) or ⏭X2, ⏭X4, ⏭X8 (forward).
- 3 Search speed and direction are indicated on the menu screen.
- 4 To exit Search mode, press PLAY(▶).

Random **CD**

- 1 Press RANDOM during playback or when playback is stopped. The unit automatically begins Random Playback and "RAND." appears on the menu screen.
- 2 To return to normal playback, press RANDOM repeatedly until "RAND." disappears from the menu screen.

Repeat A-B **CD**

To repeat a sequence.

- 1 During disc playback, press A-B at your chosen start point. The Repeat icon and "A -" appears on the menu screen.
- 2 Press A-B again at your chosen end point. The Repeat icon and "A B" appears on the menu screen, and the sequence begins to play repeatedly.
- 3 To exit the sequence and return to normal play, press A-B again. The Repeat icon and "OFF" appear on the menu screen.

3D Surround **CD**

This unit can produce a 3D Surround effect, which simulates multi-channel audio playback from two conventional stereo speakers (instead of the five or more speakers normally required to listen to multi-channel audio from a home theater system).

- 1 Press DISPLAY or AUDIO during playback.
- 2 Use ◀▶ to select the sound icon  . The Sound icon will be highlighted.
- 3 Use ▲/▼ to select "3D SUR". To turn off the 3D Surround effect, select "NORM.".

Changing the Audio Channel **CD**

Press AUDIO repeatedly during playback to hear a different audio channel (STER., LEFT, or RIGHT).

MP3 Disc Operation

Playing MP3 Discs **MP3**

The DVD Player can play MP3 formatted recordings on CD-ROM, CD-R or CD-RW discs.

Before playing MP3 recordings, read the "Notes on MP3 Discs" at right.

1 Insert an MP3 disc and close the tray.

The MP3/JPEG/WMA selection menu appears on the TV screen.



2 Use ▲/▼ to select the MP3 option then press ENTER.

The MP3 menu appears on the TV screen.

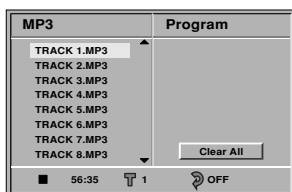

MP3 Menu

3 Use ▲/▼ to select a track then press PLAY (▶) or ENTER to start playback.

During playback, the current track's elapsed playing time will appear on the display.

Playback will stop at the end of the disc.

4 To stop playback at any other time, press STOP (■).

Press RETURN to go to the MP3/JPEG/WMA selection menu.

Pause **MP3**

1 Press PAUSE/STEP (⏸) during playback.

2 To return to normal playback, press PLAY (▶) or press PAUSE/STEP (⏸) again.

Moving to another Track **MP3**

• Press REW (⏮) or FF (⏭) during playback to advance to the next track or to return to the beginning of the current track.

• Press REW (⏮) twice to step back to the previous track.

Repeat Track/All/Off **MP3**

1 To repeat the track currently playing, press REPEAT.

The Repeat Track icon appears on the menu screen.

2 To repeat all tracks on a disc, press REPEAT twice.

The Repeat All icon appears on the menu screen.

3 To cancel Repeat mode, press REPEAT until the Repeat Off icon appears on the menu screen.

Note

- The REPEAT button is not available when the mark appears. Press PROG. PLAY to clear the mark.

Notes on MP3 Discs

About MP3

- An MP3 file is audio data compressed using the MPEG1, audio layer 3 file-coding scheme. Files with the .mp3 file extension are called MP3 files.
- The DVD+VCR cannot read an MP3 file that has a file extension other than .mp3.
- The DVD+VCR cannot read a fake MP3 file that has a file extension .mp3.

MP3 disc compatibility with this DVD+VCR is limited as follows:

1. Sampling Frequency: 44.1kHz only
2. Bit rate: 32 - 320kbps.
3. CD-R physical format should be ISO 9660.
4. If you record MP3 files using software which cannot create a FILE SYSTEM, for example Direct-CD etc., it is impossible to play back MP3 files. It is therefore recommended that you use Easy-CD Creator, which creates an ISO9660 file system.
5. A single session disc requires MP3 files in the first track. If there is no MP3 file in the first track, the unit cannot play back MP3 files. If you wish to play back MP3 files, format all the data on the disc or use a new one.
This player can play CD-DA Multi-session discs. But, playability cannot be guaranteed for all other Multi-session discs.
6. File names should be named using 8 or fewer letters and must incorporate the .mp3 extension e.g. "*****.mp3".
7. Do not use special characters, such as "_?!><+*}{[@] ; , . " etc.
8. The total number of files on the disc should be 200 or less.
If a disc contains more than 200 files, the files numbered 201 or above cannot be displayed or played back.
9. Use 74 minute CD-R discs (650M). Do not use 80 minute CD-R (700M) software.

The DVD+VCR requires discs/recordings to meet certain technical standards in order to achieve optimal playback quality. Pre-recorded DVDs are automatically set to these standards. There are many different types of recordable disc formats (including CD-Rs containing MP3 files).

Customers should also note that permission is required in order to download MP3 files and music from the Internet. Our company has no right to grant such permission. Permission should always be sought from the copyright owner.

JPEG Disc Operation

Viewing JPEG Files on a Disc **JPEG**

The DVD+VCR can play discs with JPEG files. Make sure the resolution of the JPEG files is less than 2 megapixels (2M).

Notes

- Depending upon the size and number of the JPEG files, it could take a long time for the DVD player to read the disc's contents. If you don't see an on-screen display after several minutes, some of the files may be too big — reduce the resolution of the JPEG files to less than 2 megapixels and burn another disc.
- The total number of files on the disc should be less than 200.
- Some discs/files may be incompatible due to different recording formats or the condition of the discs/files.

1 Insert a disc and close the tray.

The MP3/JPEG/WMA selection menu appears on the TV screen.



2 Use ▲/▼ to select the JPEG option, then press ENTER.

The JPEG menu appears on the TV screen. Press RETURN to move to the previous menu (MP3/JPEG/WMA selection menu).

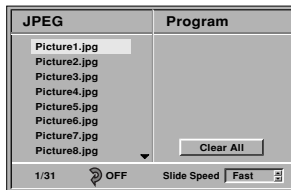

JPEG Menu

3 If you want to view a particular file, use ▲/▼ to highlight the file and press ENTER or PLAY(▶).

While viewing the file, press DISPLAY or RETURN to move to the previous menu (JPEG menu).

Tip

There are three Slide Speed options: Fast, Normal, and Slow. Use ◀/▶ to highlight the Slide Speed option, then use ▲/▼ to select the speed you want to use and press ENTER.

4 To stop viewing at any other time, press STOP (■).

The JPEG menu appears. Press RETURN to move to the MP3/JPEG/WMA selection menu.

Moving to another File

- Press REW (◀◀) or FF (▶▶) once during viewing to advance to the next or previous file.

Repeat All/Off

- 1 To repeat all files on a disc, press REPEAT when the JPEG menu appears.

The Repeat All icon appears on the menu screen.

- 2 Press PLAY(▶) or ENTER to start repeat playback.

- 3 To cancel Repeat mode, first press STOP (■) to stop playback then press REPEAT when the JPEG menu appears.

The Repeat Off icon appears on the menu screen.

Note

The REPEAT button is not available when the [E] mark appears. Press PROG. PLAY to clear the [E] mark.

Notes on JPEG Files

- When you are using software such as “Easy CD Creator” to burn the JPEG files on the CD-R, ensure that all the selected files have the “.jpg” extension when copying into a CD layout.
- If the files have “.jpe” or “.jpeg” extensions, please rename them as “.jpg” files.
- File names without the “.jpg” extension will not be able to be read by this DVD+VCR; even though the files are shown as JPEG image files in Windows Explorer.

WMA Disc Operation

Playing WMA Discs **WMA**

The DVD Player can play WMA formatted recordings on CD-ROM, CD-R, or CD-RW discs.

1 Insert a disc and close the tray.

The MP3/JPEG/WMA selection menu appears on the TV screen.



2 Use ▲/▼ to select WMA, then press ENTER.

The WMA menu appears on the TV screen.

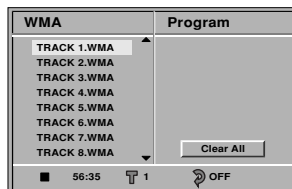

WMA Menu

3 Use ▲/▼ to select a track then press PLAY (▶) or ENTER to start playback.

During playback, the current track's elapsed playing time will appear on the display. Playback will stop at the end of the disc.

4 To stop playback at any other time, press STOP (■).

Press RETURN to move to the MP3/JPEG/WMA selection menu.

Pause **WMA**

- 1 Press PAUSE/STEP (⏸) during playback.
- 2 To return to normal playback, press PLAY (▶) or press PAUSE/STEP (⏸) again.



Moving to another Track **WMA**

- Press REW (⏮) or FF (⏭) during playback to advance to the next track or to return to the beginning of the current track.
- Press REW (⏮) twice to step back to the previous track.

Repeat Track/All/Off **WMA**

- 1 To repeat the track currently playing, press REPEAT. The Repeat Track icon appears on the menu screen.
- 2 To repeat all tracks on a disc, press REPEAT twice. The Repeat All icon appears on the menu screen.
- 3 To cancel Repeat mode, press REPEAT until the Repeat Off icon appears on the menu screen.

Note

- The REPEAT button is not available when the  mark appears. Press PROG. PLAY to clear the  mark.

WMA Disc compatibility with this player is limited as follows:

1. Sampling Frequency: 32 - 44kHz.
2. Bit rate: 48 - 80kbps.

Programmed Playback **CD** **MP3** **JPEG** **WMA**

Programmed Playback with Audio CD, MP3, JPEG and WMA

Discs **CD** **MP3** **JPEG** **WMA**

Program allows you to store your favorite tracks (or files) for a particular disc in the player memory. A program can contain up to 32 tracks (Audio CD) or 60 tracks (MP3/JPEG/WMA disc).

1 Insert a disc and close the tray.

- The Audio CD menu appears.
- If an MP3, JPEG, or WMA disc is inserted, the MP3/JPEG/WMA selection menu appears on the TV screen.
Use ▲/▼ to select MP3, JPEG, or WMA then press ENTER. The MP3, JPEG, or WMA menu appears on the TV screen. Press RETURN to move to the previous menu (MP3/JPEG/WMA selection menu).

2 Press PROG. PLAY in Stop mode or during playback (Audio CD, MP3 and WMA only) to enter Program Edit mode.

The  mark will appear to the right of the word Program on the right side of the menu screen.

Note

Press PROG. PLAY to exit Program Edit mode; the  mark will disappear.

3 Use ▲/▼ to select a track/file then press ENTER to place the selected track/file on the Program list.

4 Repeat step 3 to place additional tracks/files in the Program list.

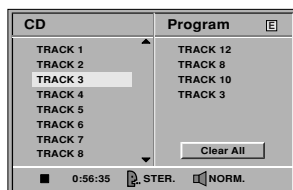

For example: Audio CD menu

5 Press ►.

The programmed track/file you selected last is highlighted on the program list.

6 Use ▲/▼ to select the track/file you want to start playing.

7 Press ENTER or PLAY (►) to start.

Playback begins in the order in which you programmed the tracks/files and "PROG." appears on the front panel display. Playback stops after playing the last programmed track/file on the program list.

Note

The programmed tracks/files are cleared when the power is turned off or the disc is removed.

Repeat Programmed Tracks/All/Off



CD **MP3** **WMA**

- 1 To repeat the track currently playing, press REPEAT. The Repeat Track icon appears on the menu screen.
- 2 To repeat all tracks on the program list, press REPEAT twice. The Repeat All icon appears on the menu screen.
- 3 To cancel Repeat mode, press REPEAT until the Repeat Off icon appears on the menu screen.

Repeat Programmed All/Off **JPEG**

- 1 To repeat all files on the program list, press REPEAT when the JPEG menu appears. The Repeat All icon appears on the menu screen.
- 2 Press PLAY (►) or ENTER to start repeat playback.
- 3 To cancel Repeat mode, first press STOP (■) to stop playback then press REPEAT when the JPEG menu appears.

Note

The REPEAT button is not available when the  mark appears. Press PROG. PLAY to clear the  mark.

Erasing a Track/File from the Program List

- 1 Press PROG. PLAY during playback or in Stop mode to enter Program Edit mode. The  mark will appear.

Note

JPEG files can be programmed only in Stop mode (when the menu screen is displayed.)

- 2 Press ► to move to the Program list.
- 3 Use ▲/▼ to select the track/file you wish to erase from the Program list.
- 4 Press CLEAR. The track/file will be erased from the Program list.

Erasing the Complete Program List

- 1 Follow steps 1-2 of "Erasing a Track/File from the Program List" as above.
- 2 Use ▲/▼ to select "Clear All", then press ENTER. The complete Program for the disc will be erased. The programs are also cleared when the disc is removed.

Troubleshooting

Check the following guide for the possible cause of a problem before contacting service.

Symptom	Cause	Correction
No power.	<ul style="list-style-type: none"> The power cord is disconnected. 	<ul style="list-style-type: none"> Plug the power cord securely into the wall outlet.
The power is on, but the DVD+VCR does not work.	<ul style="list-style-type: none"> No disc is inserted. No tape is inserted. 	<ul style="list-style-type: none"> Insert a disc or tape. (Check that the disc or tape indicator is lit on the front panel display.)
No picture.	<ul style="list-style-type: none"> The TV is not set to receive DVD+VCR signal output. 	<ul style="list-style-type: none"> Select the appropriate video input on the TV so the picture from the DVD+VCR appears on the TV screen.
	<ul style="list-style-type: none"> TV/VCR mode for DVD+VCR is set to TV. 	<ul style="list-style-type: none"> Press the TV/VCR button on the remote control repeatedly to choose VCR mode. The TV indicator will disappear on the front panel display.
	<ul style="list-style-type: none"> The video cable is not connected securely. 	<ul style="list-style-type: none"> Connect the video cable securely.
	<ul style="list-style-type: none"> The connected TV power is turned off. 	<ul style="list-style-type: none"> Turn on the TV.
No sound.	<ul style="list-style-type: none"> The equipment connected with the audio cable is not set to receive DVD+VCR signal output. 	<ul style="list-style-type: none"> Select the correct input on the audio receiver so you can listen to the sound from the DVD+VCR.
	<ul style="list-style-type: none"> The audio cables are not connected securely. 	<ul style="list-style-type: none"> Connect the audio cables securely.
	<ul style="list-style-type: none"> The power of the equipment connected with the audio cables is turned off. 	<ul style="list-style-type: none"> Turn on the equipment connected with the audio cables.
	<ul style="list-style-type: none"> The Digital Audio Output is set to the wrong position. 	<ul style="list-style-type: none"> Set the Digital Audio Output to the correct position, then turn on the DVD+VCR again by pressing POWER.
The playback picture is poor.	<ul style="list-style-type: none"> The disc is dirty. 	<ul style="list-style-type: none"> Clean the disc.
	<ul style="list-style-type: none"> Tape heads are dirty. 	<ul style="list-style-type: none"> Clean video heads.
	<ul style="list-style-type: none"> Tape is a rental or was recorded on another VCR. 	<ul style="list-style-type: none"> Use CH/TRK (▲/▼) for manual tracking adjustment while tape is playing.
The DVD+VCR does not start playback.	<ul style="list-style-type: none"> No disc is inserted. No tape is inserted. 	<ul style="list-style-type: none"> Insert a disc or tape. (Check that the disc or tape indicator is lit on the front panel display.)
	<ul style="list-style-type: none"> An unplayable disc is inserted. 	<ul style="list-style-type: none"> Insert a playable disc. (Check the disc type, color system, and Regional code.)
	<ul style="list-style-type: none"> The disc is placed upside down. 	<ul style="list-style-type: none"> Place the disc with the playback side down.
	<ul style="list-style-type: none"> The disc is not placed within the guide. 	<ul style="list-style-type: none"> Place the disc on the disc tray correctly inside the guide.
	<ul style="list-style-type: none"> The disc is dirty. 	<ul style="list-style-type: none"> Clean the disc.
	<ul style="list-style-type: none"> The Rating level is set. 	<ul style="list-style-type: none"> Cancel the Rating function or change the rating level.
The remote control does not work properly.	<ul style="list-style-type: none"> The remote control is not pointed at the remote sensor on the DVD+VCR. 	<ul style="list-style-type: none"> Point the remote control at the remote sensor on the DVD+VCR.
	<ul style="list-style-type: none"> The remote control is too far from the DVD+VCR. 	<ul style="list-style-type: none"> Operate the remote control within 23 ft (7 m).
	<ul style="list-style-type: none"> There is an obstacle in the path of the remote control and the DVD+VCR. 	<ul style="list-style-type: none"> Remove the obstacle.
	<ul style="list-style-type: none"> The batteries in the remote control are dead. 	<ul style="list-style-type: none"> Replace the batteries with new ones.
	<ul style="list-style-type: none"> This remote control uses the same buttons for VCR and DVD functions (ex. PLAY). 	<ul style="list-style-type: none"> When using the VCR deck, first press the VCR button. When using the DVD deck, first press the DVD button.

Troubleshooting (Continued)

Symptom	Cause	Correction
Some channels are skipped over when using CH/TRK (▲/▼)	<ul style="list-style-type: none"> The skipped channels were deleted with the CH. ADD/DEL option. 	<ul style="list-style-type: none"> Use CH. ADD/DEL. to restore channels. See "Channel Selection" on page 16.
Picture and sound of broadcasting channel are weak or missing.	<ul style="list-style-type: none"> Antenna or cables are loose. 	<ul style="list-style-type: none"> Tighten connections or replace cable.
	<ul style="list-style-type: none"> Wrong TUNING BAND option is being used. 	<ul style="list-style-type: none"> Try all TUNING BAND options. See "Channel Selection" on page 16 for details.
Camcorder image is not shown.	<ul style="list-style-type: none"> Camcorder is off. 	<ul style="list-style-type: none"> Turn camcorder on and operate properly.
Camcorder image via A/V input to DVD+VCR is not shown on TV screen.	<ul style="list-style-type: none"> DVD+VCR SOURCE SELECT is not set to LINE1 or LINE2. 	<ul style="list-style-type: none"> Press INPUT to select LINE input channel (LINE1 or LINE2).
Timer recording is not possible.	<ul style="list-style-type: none"> Clock in DVD+VCR is not set to correct time. 	<ul style="list-style-type: none"> Set clock to correct time. See "Setting the Clock" on page 17.
	<ul style="list-style-type: none"> Timer has been programmed incorrectly. 	<ul style="list-style-type: none"> Reprogram Timer. See "Timer Recording" on pages 23 and 24.
	<ul style="list-style-type: none"> ⌚ indicator does not appear after programming timer. 	<ul style="list-style-type: none"> Reprogram Timer.
⌚ indicator appears after DVD+VCR is turned off.	<ul style="list-style-type: none"> DVD+VCR is in Timer Recording mode. 	<ul style="list-style-type: none"> This is the normal indication that the DVD+VCR is in Timer mode.
Stereo Audio Record and/or Playback is not present.	<ul style="list-style-type: none"> TV is not Stereo-compatible. 	<ul style="list-style-type: none"> No action is possible.
	<ul style="list-style-type: none"> Broadcast program is not in stereo format. 	<ul style="list-style-type: none"> No action is possible.
	<ul style="list-style-type: none"> DVD+VCR A/V Out jacks are not connected to TV A/V In jacks. 	<ul style="list-style-type: none"> Make A/V connections. Stereo is available only via A/V output from DVD+VCR.
	<ul style="list-style-type: none"> DVD+VCR Audio/Video Out is not selected for viewing at the TV. 	<ul style="list-style-type: none"> Select AUX or A/V source as TV input.
	<ul style="list-style-type: none"> DVD+VCR BROADCAST TYPE mode is set to SAP or MONO. 	<ul style="list-style-type: none"> Set BROADCAST TYPE mode to STEREO. See "Setting the VCR Setup Menu" on page 16.

Moisture Condensation

Moisture condensation can occur:	In locations where moisture condensation may occur:
<ul style="list-style-type: none"> When the DVD+VCR is moved from a cold place to a warm place. Under extremely humid conditions. 	<ul style="list-style-type: none"> Keep the DVD+VCR plugged into an AC power outlet with POWER On. This will help prevent condensation. When condensation has occurred, wait a few hours for the DVD+VCR to dry before using it.

Language Code List

Enter the appropriate code number for the “Disc Audio”, “Disc Subtitle” and/or “Disc Menu” settings (see page 19).

Language	Code	Language	Code	Language	Code	Language	Code
Abkhazian	6566	Fiji	7074	Lingala	7678	Singhalese	8373
Afar	6565	Finnish	7073	Lithuanian	7684	Slovak	8375
Afrikaans	6570	French	7082	Macedonian	7775	Slovenian	8376
Albanian	8381	Frisian	7089	Malagasy	7771	Somali	8379
Amharic	6577	Galician	7176	Malay	7783	Spanish	6983
Arabic	6582	Georgian	7565	Malayalam	7776	Sudanese	8385
Armenian	7289	German	6869	Maltese	7784	Swahili	8387
Assamese	6583	Greek	6976	Maori	7773	Swedish	8386
Aymara	6588	Greenlandic	7576	Marathi	7782	Tagalog	8476
Azerbaijani	6590	Guarani	7178	Moldavian	7779	Tajik	8471
Bashkir	6665	Gujarati	7185	Mongolian	7778	Tamil	8465
Basque	6985	Hausa	7265	Nauru	7865	Tatar	8484
Bengali; Bangla	6678	Hebrew	7387	Nepali	7869	Telugu	8469
Bhutani	6890	Hindi	7273	Norwegian	7879	Thai	8472
Bihari	6672	Hungarian	7285	Oriya	7982	Tibetan	6679
Breton	6682	Icelandic	7383	Panjabi	8065	Tigrinya	8473
Bulgarian	6671	Indonesian	7378	Pashto, Pushto	8083	Tonga	8479
Burmese	7789	Interlingua	7365	Persian	7065	Turkish	8482
Byelorussian	6669	Irish	7165	Polish	8076	Turkmen	8475
Cambodian	7577	Italian	7384	Portuguese	8084	Twi	8487
Catalan	6765	Japanese	7465	Quechua	8185	Ukrainian	8575
Chinese	9072	Javanese	7487	Rhaeto-Romance	8277	Urdu	8582
Corsican	6779	Kannada	7578	Romanian	8279	Uzbek	8590
Croatian	7282	Kashmiri	7583	Russian	8285	Vietnamese	8673
Czech	6783	Kazakh	7575	Samoaan	8377	Volapük	8679
Danish	6865	Kirghiz	7589	Sanskrit	8365	Welsh	6789
Dutch	7876	Korean	7579	Scots Gaelic	7168	Wolof	8779
English	6978	Kurdish	7585	Serbian	8382	Xhosa	8872
Esperanto	6979	Laothian	7679	Serbo-Croatian	8372	Yiddish	7473
Estonian	6984	Latin	7665	Shona	8378	Yoruba	8979
Faeroese	7079	Latvian, Lettish	7686	Sindhi	8368	Zulu	9085

Country Code List

Enter the appropriate code number for the "Country Code" setting (see page 21).

Code	Country	Code	Country	Code	Country	Code	Country
AD	Andorra	ER	Eritrea	LC	Saint Lucia	SC	Seychelles
AE	United Arab Emirates	ES	Spain	LI	Liechtenstein	SD	Sudan
AF	Afghanistan	ET	Ethiopia	LK	Sri Lanka	SE	Sweden
AG	Antigua and Barbuda	FI	Finland	LR	Liberia	SG	Singapore
AI	Anguilla	FJ	Fiji	LS	Lesotho	SH	Saint Helena
AL	Albania	FK	Falkland Islands	LT	Lithuania	SI	Slovenia
AM	Armenia	FM	Micronesia	LU	Luxembourg	SJ	Svalbard and Jan Mayen Islands
AN	Netherlands Antilles	FO	Faroe Islands	LV	Latvia	SK	Slovak Republic
AO	Angola	FR	France	LY	Libya	SL	Sierra Leone
AQ	Antarctica	FX	France (European Territory)	MA	Morocco	SM	San Marino
AR	Argentina	GA	Gabon	MC	Monaco	SN	Senegal
AS	American Samoa	GB	Great Britain	MD	Moldavia	SO	Somalia
AT	Austria	GD	Grenada	MG	Madagascar	SR	Suriname
AU	Australia	GE	Georgia	MH	Marshall Islands	ST	Saint Tome and Principe
AW	Aruba	GF	French Guyana	MK	Macedonia	SU	Former USSR
AZ	Azerbaijan	GH	Ghana	ML	Mali	SV	El Salvador
BA	Bosnia-Herzegovina	GI	Gibraltar	MM	Myanmar	SY	Syria
BB	Barbados	GL	Greenland	MN	Mongolia	SZ	Swaziland
BD	Bangladesh	GM	Gambia	MO	Macau	TC	Turks and Caicos Islands
BE	Belgium	GN	Guinea	MP	Northern Mariana Islands	TD	Chad
BF	Burkina Faso	GP	Guadeloupe (French)	MQ	Martinique (French)	TF	French Southern Territories
BG	Bulgaria	GQ	Equatorial Guinea	MR	Mauritania	TG	Togo
BH	Bahrain	GR	Greece	MS	Montserrat	TH	Thailand
BI	Burundi	GS	S. Georgia & S. Sandwich Isls.	MT	Malta	TJ	Tadjikistan
BJ	Benin	GT	Guatemala	MU	Mauritius	TK	Tokelau
BM	Bermuda	GU	Guam (USA)	MV	Maldives	TM	Turkmenistan
BN	Brunei Darussalam	GW	Guinea Bissau	MW	Malawi	TN	Tunisia
BO	Bolivia	GY	Guyana	MX	Mexico	TO	Tonga
BR	Brazil	HK	Hong Kong	MY	Malaysia	TP	East Timor
BS	Bahamas	HM	Heard and McDonald Islands	MZ	Mozambique	TR	Turkey
BT	Bhutan	HN	Honduras	NA	Namibia	TT	Trinidad and Tobago
BV	Bouvet Island	HR	Croatia	NC	New Caledonia (French)	TV	Tuvalu
BW	Botswana	HT	Haiti	NE	Niger	TW	Taiwan
BY	Belarus	HU	Hungary	NF	Norfolk Island	TZ	Tanzania
BZ	Belize	ID	Indonesia	NG	Nigeria	UA	Ukraine
CA	Canada	IE	Ireland	NI	Nicaragua	UG	Uganda
CC	Cocos (Keeling) Islands	IL	Israel	NL	Netherlands	UK	United Kingdom
CF	Central African Republic	IN	India	NO	Norway	UM	USA Minor Outlying Islands
CG	Congo	IO	British Indian Ocean Territory	NP	Nepal	US	United States
CH	Switzerland	IQ	Iraq	NR	Nauru	UY	Uruguay
CI	Ivory Coast	IR	Iran	NU	Niue	UZ	Uzbekistan
CK	Cook Islands	IS	Iceland	NZ	New Zealand	VA	Vatican City State
CL	Chile	IT	Italy	OM	Oman	VC	Saint Vincent & Grenadines
CM	Cameroon	JM	Jamaica	PA	Panama	VE	Venezuela
CN	China	JO	Jordan	PE	Peru	VG	Virgin Islands (British)
CO	Colombia	JP	Japan	PF	Polynesia (French)	VI	Virgin Islands (USA)
CR	Costa Rica	KE	Kenya	PG	Papua New Guinea	VN	Vietnam
CS	Former Czechoslovakia	KG	Kyrgyzstan	PH	Philippines	VU	Vanuatu
CU	Cuba	KH	Cambodia	PK	Pakistan	WF	Wallis and Futuna Islands
CV	Cape Verde	KI	Kiribati	PL	Poland	WS	Samoa
CX	Christmas Island	KM	Comoros	PM	Saint Pierre and Miquelon	YE	Yemen
CY	Cyprus	KN	Saint Kitts & Nevis Anguilla	PN	Pitcairn Island	YT	Mayotte
CZ	Czech Republic	KP	North Korea	PR	Puerto Rico	YU	Yugoslavia
DE	Germany	KR	South Korea	PT	Portugal	ZA	South Africa
DJ	Djibouti	KW	Kuwait	PW	Palau	ZM	Zambia
DK	Denmark	KY	Cayman Islands	PY	Paraguay	ZR	Zaire
DM	Dominica	KZ	Kazakhstan	QA	Qatar	ZW	Zimbabwe
DO	Dominican Republic	LA	Laos	RE	Reunion (French)		
DZ	Algeria	LB	Lebanon	RO	Romania		
EC	Ecuador			RU	Russian Federation		
EE	Estonia			RW	Rwanda		
EG	Egypt			SA	Saudi Arabia		
EH	Western Sahara			SB	Solomon Islands		

Specifications

General

Power requirements	AC 120V, 60 Hz
Power consumption	23W
Dimensions (approx.)	430 X 97.5 X 293 mm (16.9 x 3.9 x 11.5 inches) (w x h x d)
Weight (approx.)	4.8 kg (10.58 lbs)
Operating temperature	5°C to 40°C (41°F to 104°F)
Operating humidity	5% to 90%
Signal system	NTSC

Inputs

ANTENNA IN	Antenna or CATV input, 75 ohms
VHS VIDEO IN(LINE1, 2)	1 Vp-p 75 ohms, sync negative, RCA jack x 2
VHS AUDIO IN(LINE1, 2)	-6.0 dBm more than 47 ohms, RCA jack (L, R) x 2

Outputs

VIDEO OUT	1 Vp-p 75 ohms, sync negative
S-VIDEO OUT	(Y) 1.0 V (p-p), 75 ohms, negative sync, Mini DIN 4-pin x 1 (C) 0.3 V (p-p) 75 ohms
COMPONENT VIDEO OUT (PROGRESSIVE SCAN)	(Y) 1.0 V (p-p), 75 ohms, negative sync, RCA jack x 1 (Pb)/(Pr) 0.7 V (p-p), 75 ohms, RCA jack x 2
Audio output (digital audio)	0.5 V (p-p), 75 ohms, RCA jack x 1
Audio output (optical audio)	5 V (p-p), 75 Ω, Optical connector x 1
Audio output (analog audio)	2.0 Vrms (1 KHz, 0 dB), 330 ohms, RCA jack (L, R) x 1
RF OUT	Channel 3 or 4

VCR Specifications

Head system	Four head helical scan azimuth system
Timer	12-hour display type with AM, PM
Tape speed	SP: 33.35 mm/sec, LP: 16.67 mm/sec, EP: 11.12 mm/sec
Tape width	12.7 mm
Maximum recording time	SP: 2 HOURS (T-120), EP: 6 HOURS (T-120)/8 HOURS (T-160)
Rewind time	About 3 minutes (T-120)
Antenna	75 ohms (VHF/UHF)
VHF output signal	Channel 3 or 4 (Switchable)
Channel coverage	VHF: 2-13, UHF: 14-69, CATV: 1-125 (4A, A-W, W+1 - W+84, A-5 - A-1)
Frequency range	20Hz to 20kHz
Signal-to-noise ratio	More than 43dB
Dynamic range	More than 88 dB
Channel separation	More than 60 dB

DVD Specifications

Laser system	Semiconductor laser, wavelength 650 nm
Frequency response	DVD (PCM 96 kHz): 8 Hz to 44 kHz, DVD (PCM 48 kHz): 8 Hz to 22 kHz CD: 8 Hz to 20 kHz
Signal-to-noise ratio	More than 100dB (ANALOG OUT jacks only)
Harmonic distortion	Less than 0.008%
Dynamic range	More than 95 dB (DVD/CD)

Accessories:

Video cable x 1, Audio cable x 1, RF 75-ohm Coaxial Cable x 1, Remote control x 1, Batteries (AAA) x 2

- Design and specifications are subject to change without prior notice.

Notes

REFERENCE

Notes

Notes

REFERENCE

LIMITED WARRANTY

GOVIDEO DVD+VCR LIMITED WARRANTY

Who Provides the Limited Warranty

During the warranty period, the GoVideo Warranty Administrator will honor DVD+VCR service for 90 days labor, 1 year parts from the original date of consumer purchase. See below for Commercial, Industrial or Educational use coverage. The DVD+VCR remote control is warranted for 90 days from the date of purchase.



Who is Protected

This warranty protects the original consumer owner of this GoVideo product.

What is Covered and How Long

This warranty covers internal operating parts and service/labor to repair or replace covered parts in this GoVideo product for 90 days labor, 1 year parts, from the date of purchase, defined as follows: (1) Original Consumer Retail Purchase; (2) First Rental Purchase Agreement; or (3) First Lease Purchase Agreement (the "Warranty Period"). Labor and replacement parts supplied during the Warranty Period are covered only for the remaining portion of the original Warranty Period. The GoVideo Warranty Administrator shall have no liability for service under this warranty if non-OEM (Original Equipment Manufacturer) replacement parts are used in the repair of your GoVideo product.

What the Owner Must Do If Service is Required

If service under this warranty is required, log onto "www.govideo.com" to determine the nearest authorized GoVideo service center.

Other Warranty Coverage

Commercial, Industrial or Educational use has the same warranty coverage as stated in this warranty.

What are the Exceptions

This warranty does not cover: (1) Normal maintenance service, such as video head cleaning. (2) Damage from misuse, abuse, neglect or accident, natural disasters or Acts of God. (3) Cabinetry, decorative parts, A/C adapters, knobs or buttons. (4) The foreign country use of this product. (5) GoVideo product which has been electronically or mechanically modified in any way or incorporated into other products. (6) Installation and setup service adjustments. (7) Owner instruction. Your Owner's Guide provides information regarding operating instructions and user controls. For additional information, contact your authorized GoVideo dealer.

Go Video is not responsible for any shipping, handling or insurance charges.

This Exclusive Limited Warranty excludes all incidental and consequential damages. Some states do not allow the exclusion of incidental and consequential damages, so the above exclusion may not apply to you.

ALL IMPLIED WARRANTIES, INCLUDING IMPLIED WARRANTIES OF MERCHANTABILITY AND FITNESS FOR A PARTICULAR PURPOSE ARE LIMITED IN DURATION TO THE DURATION OF THIS WARRANTY PERIOD. Some states do not allow limitations on how long an implied warranty lasts, so the above limitation may not apply to you.

This Exclusive Limited Warranty gives you specific legal rights and you may also have other rights which vary from state to state.

GoVideo WARRANTY ADMINISTRATOR

7835 East McClain Drive • Scottsdale, Arizona 85260-1732