

C41029G C41029V

Range Cooker

User Instructions

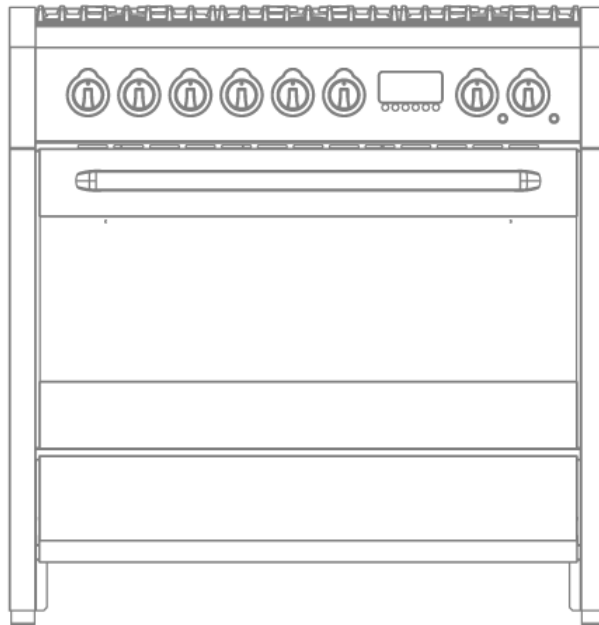



Thank you for choosing our product. From now on, cooking will always be pleasantly creative with your new cooker.

We recommend carefully reading all the instructions in this manual, which includes detailed information about the most suitable conditions for using the cooker correctly and safely. These instructions also help you to become familiar with each component.

Useful advice is given for using recipients, utensils, positions of guides and control settings.

The correct cleaning operations contained in this manual allow you to maintain the cooker's performance unchanged over time.

The individual sections are set out in order to allow you to become familiar with all the functions in the cooker. The text is easy to comprehend and is accompanied with detailed images and simple pictograms.

Reading this manual thoroughly will provide you with the answer to any question that may arise regarding the correct use of your new cooker.



INSTRUCTIONS FOR THE USER: include suggestions, the description of the controls and the correct cleaning and maintenance operations for the appliance.



INSTRUCTIONS FOR THE INSTALLER: for the **qualified technician** who is in charge of adequately checking the gas system, installing, commissioning and testing the appliance.

1. Warnings for safety and use	5
2. General information	6
2.1 Technical service	6
3. Description of controls	7
3.1 The front panel	7
4. Using the cooking hob	12
4.1 Switching on the burners	12
4.2 Switching off the burners	12
5. Using the ceramic hob	13
5.1 General warnings	13
5.2 Switching on	13
5.3 Switching off	13
6. Using the electric oven	14
6.1 General warnings	14
6.2 Switching on the oven for the first time	14
6.3 Traditional cooking	14
6.4 Convection cooking	14
6.5 Cooking with the ventilated grill	14
6.6 Cooking with the grill + spit	15
6.7 Cooking with the spit	15
6.8 Defrosting	15
6.9 Switching off the oven	15
6.10 Storage Drawer	15
7. Cooking suggestions	16
7.1 Suggestions for using the hob burners correctly	16
7.2 Suggestions for using the ceramic hob correctly	16
7.3 Suggestions for using the oven correctly	16
8. Cleaning and maintenance	19
8.1 Cleaning stainless steel surfaces	19
8.2 Cleaning enamelled surfaces	19
8.3 Cleaning the knobs and the control panel	19
8.4 Cleaning the grids and burners	19
8.5 Cleaning the igniter plugs and thermocouples	20
8.6 Cleaning the ceramic hob	20
8.7 Cleaning the oven	20
9. Special maintenance	21
9.1 Removing the oven door	21
9.2 Replacing the oven light bulb	21
10. Service and Spare Parts	22
10.1 Customer Care	22

11. Guarantee Conditions	23
11.1 Standard guarantee conditions	23
11.2 Exclusions	23
11.3 European Guarantee	23
12. Installation	24
12.1 General warnings	24
12.2 Electric connection	24
12.3 Power consumption of the ceramic hob	26
12.4 Ventilation requirements	26
12.5 Gas connection	27
12.6 Stability chain	28
12.7 Gas regulations	29
12.8 Connecting to LPG	29
13. Final operations	30
13.1 Positioning and levelling the cooker	30

CLASSES OF APPLIANCES

The cooking appliances described in this operating manual belong to the following installation classes:

- **Class 1: non-flush-mounted** cooking appliance;

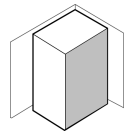

- **Class 2 – subclass 1:** cooking appliance **flush-mounted between two units**, made up of a single unit, but which can also be installed so that the side walls are accessible.

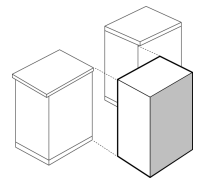

1. Warnings for safety and use

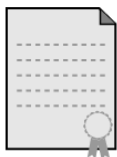

THIS MANUAL IS AN INTEGRAL PART OF THE APPLIANCE. IT SHOULD BE KEPT IN GOOD CONDITION AND CLOSE TO THE APPLIANCE FOR THE WHOLE LIFECYCLE OF THE COOKER. WE RECOMMEND READING THIS MANUAL VERY CAREFULLY BEFORE USING THE COOKER. ALSO KEEP THE SET OF NOZZLES PROVIDED. **THE INSTALLATION MUST BE CARRIED OUT BY QUALIFIED PERSONNEL AND IN COMPLIANCE WITH CURRENT STANDARDS.** THIS APPLIANCE IS FOR DOMESTIC USE AND CONFORMS TO THE **EEC DIRECTIVES** CURRENTLY IN FORCE. THE APPLIANCE IS BUILT FOR CARRYING OUT THE FOLLOWING FUNCTION: **COOKING AND HEATING FOOD**; ANY OTHER USE IS TO BE CONSIDERED IMPROPER. **THE MANUFACTURER DECLINES ANY RESPONSIBILITY SHOULD THE APPLIANCE BE USED FOR PURPOSES OTHER THAN THOSE INDICATED.**

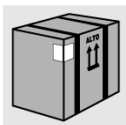

DO NOT LEAVE ANY PIECES OF THE PACKING UNATTENDED IN THE HOME. SEPARATE THE VARIOUS PACKING MATERIALS AND DELIVER THEM TO THE NEAREST RECYCLING CENTRE.

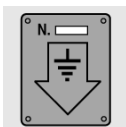

THE EARTH CONNECTION MUST CONFORM WITH THE RELEVANT IEE REGULATIONS IN FORCE.

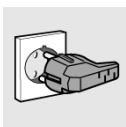

THE PLUG TO BE CONNECTED TO THE POWER SUPPLY CABLE AND THE RELATIVE SOCKET MUST BE THE SAME TYPE AND MUST COMPLY WITH CURRENT STANDARDS. **DO NOT PULL OUT THE PLUG BY PULLING THE CABLE.**



SHOULD THE GAS TAPS BE DIFFICULT TO ROTATE, CONTACT YOUR LOCAL SERVICE FORCE CENTRE.



IMMEDIATELY AFTER INSTALLATION, TEST THE APPLIANCE BRIEFLY BY FOLLOWING THE INSTRUCTIONS SHOWN BELOW. IN THE EVENT OF A MALFUNCTION, DISCONNECT THE APPLIANCE FROM THE MAINS AND CONTACT YOUR NEAREST SERVICE FORCE CENTRE. **DO NOT ATTEMPT TO REPAIR THE APPLIANCE.**



EACH TIME YOU FINISH USING THE COOKING HOB, ALWAYS CHECK THAT THE CONTROL KNOBS ARE IN "ZERO" POSITION (OFF).



NEVER PUT INFLAMMABLE OBJECTS INTO THE OVEN: SHOULD IT BE ACCIDENTALLY SWITCHED ON, A FIRE MAY BREAK OUT. **IN THE EVENT OF A FIRE: TURN OFF THE MAIN GAS SUPPLY AND DISCONNECT FROM THE MAINS SUPPLY.** DO NOT THROW WATER ON BURNING OR FRYING OIL. DO NOT STORE INFLAMMABLE OBJECTS OR AEROSOL CANS NEAR THE APPLIANCE AND DO NOT SPRAY NEAR THE BURNERS WHEN SWITCHED ON.



DO NOT USE SAUCEPANS THAT DO NOT HAVE A PERFECTLY SMOOTH, EVEN BASE ON THE HOB.

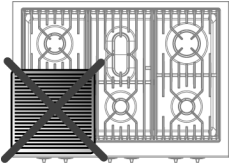

DO NOT USE ANY PAN OR ACCESSORY THAT EXCEEDS THE OUTER PERIMETER OF THE HOB.

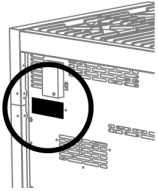

THE RATING PLATE WITH THE TECHNICAL DATA, SERIAL NUMBER AND THE BRAND IS CLEARLY VISIBLE ON THE BACK OF THE APPLIANCE.
THE PLATE MUST NEVER BE REMOVED.



THE APPLIANCE SHOULD ONLY BE USED BY ADULTS. DO NOT ALLOW CHILDREN TO APPROACH OR PLAY WITH THE APPLIANCE. DO NOT KEEP OBJECTS ON THE APPLIANCE THAT MAY ATTRACT CHILDREN'S ATTENTION. KEEP CHILDREN AWAY FROM THE APPLIANCE; DO NOT FORGET THAT SOME PARTS OF THE APPLIANCE OR THE PANS USED BECOME VERY HOT AND DANGEROUS DURING USE AND, AFTER SWITCHING OFF, WHILE THE APPLIANCE IS COOLING. BE CAREFUL WITH PAN HANDLES: KEEP THEM TURNED INWARDS SO THAT CHILDREN CANNOT OVERTURN THE PANS.



WHEN THE APPLIANCE IS DECOMMISSIONED, IT MUST BE DISPOSED OF IN A SUITABLE RECYCLING CENTRE.



The manufacturer declines any responsibility for damage incurred by persons or objects that is caused by not following the above guidelines or by tampering with any part of the appliance or by using non-original spare parts.

2. General information

This product conforms to the requirements of the following European directives:

- **73/23/EEC** for "Low Voltage".
- **89/336/EEC** for "Electromagnetic Disturbance".
- **90/396/EEC** for "Gas Appliances".
- **89/109/EEC** for "Material in contact with Food".

The above mentioned directives also conform to **Machine directive 98/37/EC**.

2.1 Technical service



Before leaving the factory, this appliance has been tested and set up by qualified, specialist personnel, so as to guarantee the best operating results. Each repair or adjustment that may subsequently be necessary must be carried out with the utmost care and attention. We therefore recommend always contacting the Dealer where the appliance was purchased or your nearest Service Centre, specifying the type of problem and the appliance model.



3. Description of controls

3.1 The front panel

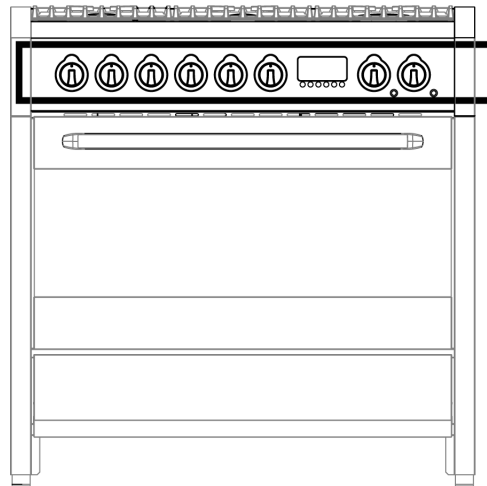

All the commands and controls for the cooking hob and oven are on the front panel.

THE CONTROL PANEL



DESCRIPTION OF HOB CONTROL KNOB

The flame is ignited by simultaneously pressing and turning the knob anticlockwise to the low flame symbol .

To regulate the size of the flame, turn the knob to between the maximum  and minimum  settings. Turn off the burner by returning the knob to position .



LAYOUT OF BURNERS – Description of symbols



REAR LEFT



CENTRE FRONT



FRONT LEFT



REAR RIGHT



CENTRE REAR



FRONT RIGHT



DESCRIPTION OF CERAMIC HOB CONTROL KNOBS

Besides the normal knobs that regulate the energy, the ceramic hob is equipped with knobs for **differentiated heating**. Settings from 1 to 11 control the heating of the internal element, setting the knob to the symbol ● the outer element also operates.

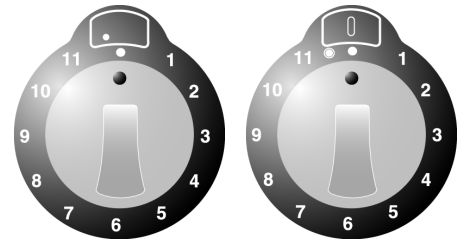

LAYOUT OF CERAMIC HEATING ELEMENTS - Description of symbols



REAR LEFT



FRONT LEFT



CENTRAL



REAR RIGHT



FRONT RIGHT

DESCRIPTION OF ELECTRIC OVEN KNOBS

The electric oven is controlled by two knobs: **function switch knob** and **thermostat knob**. They allow you to choose the most suitable type of heating for different cooking requirements, by switching on the heating elements appropriately and setting the required temperature from **50°C** to **MAX (250°C)**.

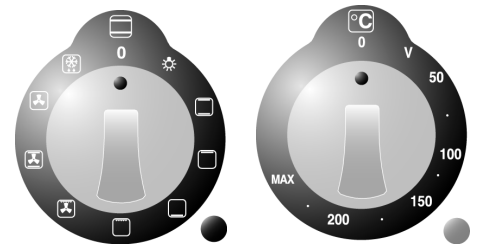

The **V** setting on the thermostat knob operates the oven fan.

Below the oven knobs there are two warning lights: the **red light** signals the oven is working; the **orange light** indicates that the preset temperature has been reached. The **orange light** switches on and off to indicate when the thermostat switches on to maintain the temperature inside the oven at the level set on the thermostat knob.

The oven has an **internal light**. The light is always on while the oven is working: it can be switched on while the oven is off, for cleaning purposes, by turning the function switch knob to the symbol ☀

DESCRIPTION OF SYMBOLS ON THE FUNCTION SWITCH KNOB



SWITCHES ON THE OVEN LIGHT



UPPER AND LOWER HEATING ELEMENTS



UPPER HEATING ELEMENT



LOWER HEATING ELEMENT



GRILL ELEMENT



GRILL-FAN ELEMENT



UPPER AND LOWER HEATING ELEMENTS – FAN



HEATING ELEMENT-CONVECTION



DEFROST



THE ELECTRONIC TIMER

KEY

A	COOK TIME
B	END TIME
C	COUNTDOWN
D	TIME
E	DECREASE CONTROL
F	SELECTOR CONTROL
G	INCREASE CONTROL

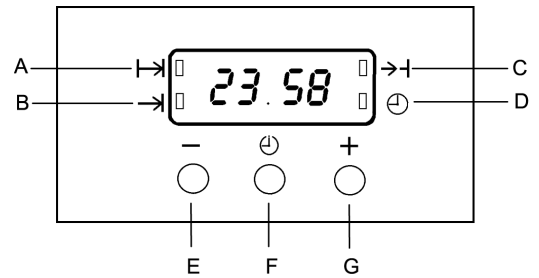

The time of day must be set before the main oven will operate manually.

SET THE TIME OF DAY

The oven has a 24 hour clock.

When the electricity supply is first switched ON, the display will show 12.00 and the 'Time' (⌚) indicator neon will flash as Fig. 1.

To set the correct time press the increase control button (+) and if necessary, the decrease control button (-) until the correct time on the 24 hour clock is reached, e.g. 10.00 a.m. as Fig. 2. The 'Time' indicator (⌚) neon will flash for 5 seconds and then go out.

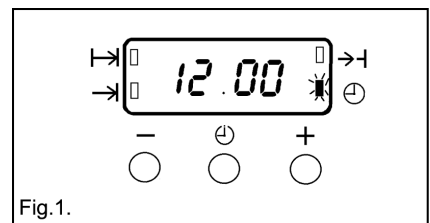

The increase and decrease control buttons operate slowly at first, and then more rapidly. They should be pressed separately.

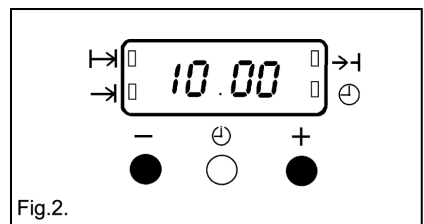

HOW TO SET THE COUNTDOWN

The 'Countdown' gives an audible reminder at the end of any period of cooking. This cooking period may be up to 2 hrs 30 mins. It is not part of the automatic control.

To set, press the Selector Control button (⌚) until the 'Countdown' indicator is illuminated (→) the display reads 0.00 as Fig. 3.

To set the correct time duration depress the increase control (+) until the display indicates the interval to be timed, e.g. 1hr 45 mins as Fig. 4. If necessary depress the decrease control (-) to achieve the correct time interval.

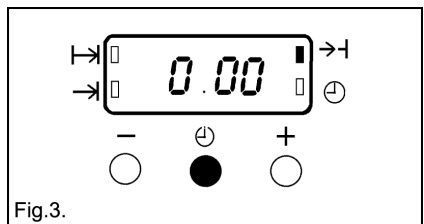

This must be completed within 5 seconds of first pressing the Selector Control button.

During the operation of the 'Countdown', the remaining time period will be shown in the display. The 'Countdown' will sound intermittently for up to 2 minutes at the end of the timed period. The sound can be stopped by pressing any button.

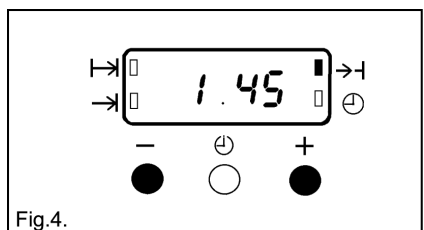



TO CANCEL THE COUNTDOWN

If you change your mind and want to cancel the 'Countdown', press the Selector Control button until the 'Countdown' indicator (→|) flashes and then the decrease control (-) until 0.00 shows in the display as Fig. 5. The 'Countdown' indicator (→|) will continue to flash for a few seconds and then return to the time of day.

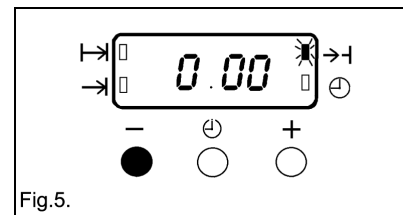

Fig.5.

SETTING THE OVEN TIMER CONTROL

The main oven can be automatically timed.

When using the timer control for the very first time, it is advisable to let it operate while you are at home. The displays can be checked to show that it is operating correctly and you will feel confident to leave a meal to cook automatically in the future.

A) TO SET THE TIMER TO SWITCH ON AND OFF AUTOMATICALLY

- i) Ensure the electricity supply is switched ON and that the correct time of day is displayed, e.g. 9 a.m. as Fig. 6.
- ii) Place food in oven.
- iii) To set the length of cooking time, press the Selector control button (⊖) until the 'Cook Time' indicator is illuminated (|→). Press the increase control (+) until the required length of cooking time is displayed, e.g. 2 hrs 15 mins as Fig. 7. If necessary depress the decrease control (-) until the correct time interval is achieved.

The maximum cooking time is 10 hours.

- iv) Release the buttons. The 'Cook Time' indicator (|→) will be illuminated.

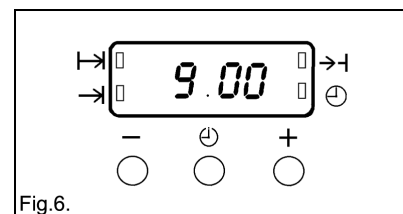

Fig.6.

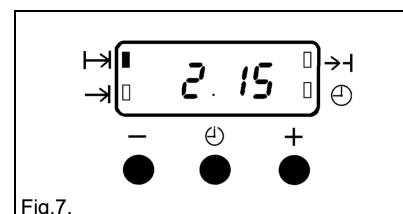

Fig.7.



Remember, this must be completed within 5 seconds of first pressing the Selector Control button.

- v) To set the 'End Time'. Press the Selector Control button until the 'End Time' (→|) flashes. Press the increase control (+) until the required stop time is displayed, e.g. 12.15 p.m. as Fig. 8. If necessary depress the decrease control (-) until the correct time interval is achieved.

- vi) Release the buttons. The time of day will be displayed after 5 seconds. The 'Cook Time' (|→) and 'End Time' (→|) indicators will be illuminated.

The 'End Time' must not be more than 23 hours 59 minutes from the time of day. For example, if the time of day is 09.00 a.m., the latest 'End Time' would be 08.59 a.m. the next day.

- vii) Set the main oven control to the required temperature. The oven indicator neon should be OFF.

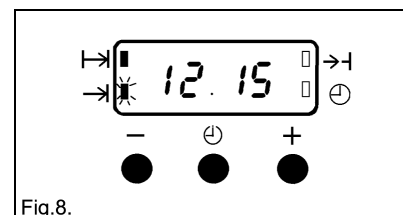

Fig.8.



When the automatic timed period starts, the oven indicator neon will turn ON and OFF periodically during cooking, showing that the temperature is being maintained.



B) TO SET THE TIMER TO SWITCH OFF ONLY

- i) Ensure the electricity supply is switched ON and that the correct time of day is displayed, e.g. 10.00 a.m. as Fig. 9.
- ii) Place food in oven.
- iii) To set the length of cooking time, press the Selector Control button until the 'Cook Time' (I→) indicator is illuminated. Press the increase control (+) until the required length of cooking time is displayed, e.g. 2 hrs 15 mins as Fig. 10. Depress the decrease control (-) if necessary.
- iv) Release the buttons. The 'Cook Time' indicator (I→) will illuminate and the time of day will be displayed after 5 seconds.
- v) Set the oven temperature. The oven indicator neon should be ON.
- vi) To check the 'End Time' during the cooking period, simply press the Selector Control button once and the remaining time will be displayed, as Fig. 11.

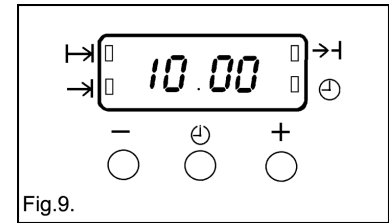

Fig.9.

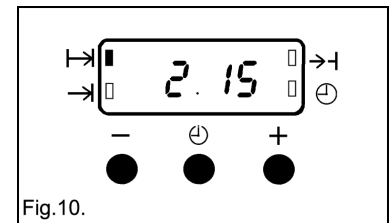

Fig.10.

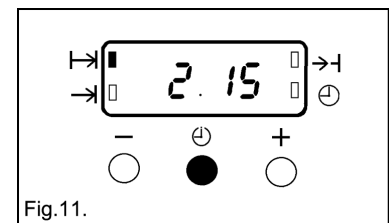

Fig.11.

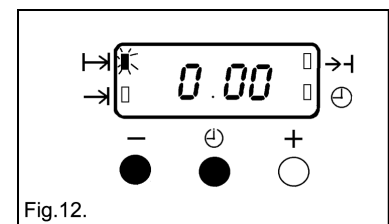

Fig.12.

TO CANCEL AN AUTOMATIC PROGRAMME

- i) To cancel an automatic programme press the Selector Control button until the 'Cook Time' indicator (I→) neon flashes. Press the decrease control (-) until the display reads 0.00 as Fig. 12.
- ii) Release the buttons. The 'Cook Time' indicator (I→) will flash and after 5 seconds return to the time of day.
- iii) Turn off oven control.

TO RETURN THE APPLIANCE TO MANUAL

At the end of a timed cooking period, the indicator neon will flash and an alarm will sound for up to 2 minutes.

- i) To stop the sound press any of the three buttons, as Fig. 13.
- ii) The display will return to the time of day.
- iii) Turn off the oven controls.

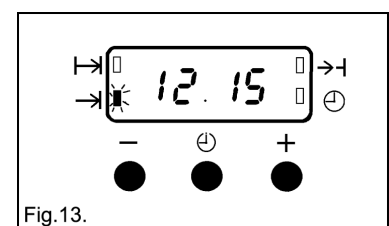

Fig.13.

THINGS TO NOTE

In the event of an interruption of the electricity supply, the timer will reset itself to zero, and all programming will be cancelled.

AUTOMATIC COOKING

It is advisable to leave food in the oven for as short a time as possible before automatic cooking. Always ensure commercially prepared food is well within its use by date and that home prepared food is fresh and of good quality.

When cooking is complete, **do not** leave food to stand in the oven, but remove and cool it quickly if the food is not to be consumed immediately.

Always ensure food in the oven has been covered before cooking if it is not possible to remove food immediately after cooking.



4. Using the cooking hob



Make sure that the flame caps, the burner caps and the pan supports are fitted correctly.



During normal operations, the appliance heats up considerably. Caution should therefore be used. **Do not allow children to approach the appliance.** Do not leave the cooking hob unattended while it is on.

4.1 Switching on the burners



All the hob burner knobs have the following symbols:

- OFF
- 🔥 high flame
- 🔥 low flame

The low flame setting is found by turning the knob anticlockwise all the way. All intermediate settings must be selected between the high flame and low flame, **never between high flame and closed**.

4.1.1 One-touch lighting

The hob burners are equipped with a "one-touch" lighting system. To switch on one of the burners, press the knob corresponding to the required burner and turn it anticlockwise to the low setting 🔥. Hold down the knob to activate the automatic "one-touch" lighting system. When the burner is on, hold down the knob for approximately **10 seconds**, to allow the safety valve to open. In the event of a power cut, the burner can also be lit with a match (see section "4.1.2 Manual lighting").



Should the burner switch off accidentally, the safety thermocouple blocks the gas flow, even when the tap is open.

4.1.2 Manual lighting

To light one of the burners, move a lit match towards the burner, press the corresponding knob and turn it anticlockwise to the minimum setting 🔥. Release the knob.

4.2 Switching off the burners

At the end of the cooking, return the knob to position ●.



5. Using the ceramic hob



During normal operations, the appliance heats up considerably. Caution should therefore be used. **Do not allow children to approach the appliance. Do not leave the ceramic hob unattended while it is on.**

5.1 General warnings

The first time it is heated, the ceramic hob may develop an acrid or burnt smell caused by oily residue from manufacturing, which disappears completely after repeated use.

The ceramic hob is fitted with a cooking area with various diameters and power (see section “12.3 Power consumption of the ceramic hob”). Their position is clearly indicated with circles and the heat is delimited within the diameters marked on the glass.

5.2 Switching on

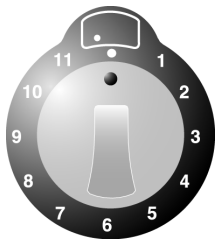

Position the pan or pot with the food to be cooked inside it on the required heating element. Turn the energy regulator knob to the required setting. After a few moments, the **residual heat indicator** corresponding to the selected heating element switches on.

If the ceramic hob is used to boil water, once it has boiled, turn the energy regulator knob to a lower setting to prevent the liquid in the pot from boiling over and soiling the surface.

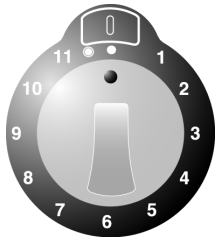

Some knobs are fitted with a **supplementary heating setting (griddle with dual heating element)**. To activate it, turn the energy regulator knob to position ●.

5.3 Switching off

After cooking, return the knob to position ●.

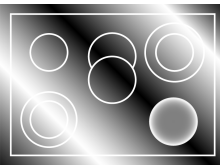

The ceramic hob features a **residual heat indicator** which reproduces in reduced scale the position of the heating diameters. This light indicates that the surface area is still hot.



Do not clean or touch the surface until the residual heat indicator has switched off.



6. Using the electric oven



When the oven or grill is operating, the outer surface and oven door can become very hot. **Keep children away from the appliance. Do not allow children to sit on the oven door or play with it. Do not use the door as a stool.**

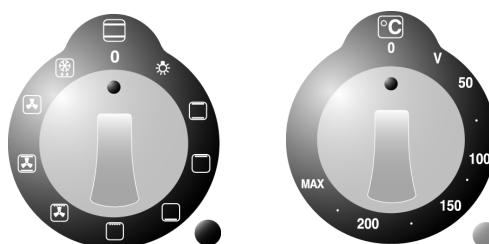

6.1 General warnings

Do not cook food on the bottom of the oven.

When using the oven for the first time, or after a power cut, the display flashes regularly indicating **0:00**. To set the display, refer to section "SET THE TIME OF DAY" on page 9.

Do not attempt to remove the oven door without consulting the relative instructions carefully (refer to section "9.1 Removing the oven door"): **the hinges on the oven door may cause an injury.**

6.2 Switching on the oven for the first time

The first time it is used, the oven may smoke or give off an acrid smell caused by oily residue from manufacturing that may give unpleasant odours or flavours to food. **Before putting food in the oven, heat to the maximum temperature for 30-40 minutes with the door closed and wait until the smoke or odour has stopped.**





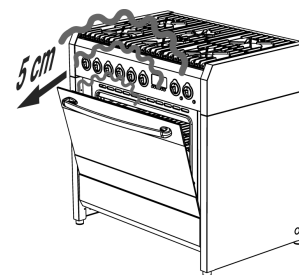

To prevent any steam in the oven from scalding, proceed as follows: turn the function switch knob to "0", or to function ; open the door in two stages: hold it partly open (**approx. 5 cm**) for 4-5 seconds, then open it completely.

Should you need to adjust the food, leave the door open for as short a time as possible to prevent the temperature inside the oven from lowering to such an extent as to affect cooking.



6.3 Traditional cooking

Turn the function switch knob to position  and the thermostat knob to the required temperature. To finish cooking the dish, turn the selector switch to position  (top heat) or  (bottom heat) if necessary. For more uniform heating throughout the oven, turn the function switch knob to position .

6.4 Convection cooking

Turn the function switch knob to position ; turn the thermostat knob in correspondence with the required temperature value.

6.5 Cooking with the ventilated grill

Turn the function switch knob to position ; turn the thermostat knob to set maximum temperature value (**MAX**).



6.6 Cooking with the grill + spit

Turn the function switch knob to position ; turn the thermostat knob to the maximum temperature (**MAX**). The grill and spit operate at the same time.

6.7 Cooking with the spit

Proceed as follows:

- insert the spit supports **A** into the appropriate holes **B** on the sides on the dripping pan, taking care that the support including the rod **C** is on the left hand side of the dripping pan;
- screw the handle **D** onto the spit rod;
- slide the meat to be cooked on to the spit rod using the appropriate adjustable forks to secure it;
- slide the spit rod into the hole **E** on the left hand support;
- remove the handle **D** from the spit rod and position the dripping pan in the first position from the bottom;
- before closing the oven door, make sure that the rod **C** is properly inserted in the hole **F** (while inserting it, turn the spit rod slightly clockwise and anticlockwise);
- start the spit by turning the function switch knob to position .

In addition to the adjustable forks, the spit is also provided with 3 disks **G** that, correctly fitted on the rod **H**, will accommodate up to 8 kebabs **I**. Remove the kebabs from the disk by simply rotating the eyelet **L**, which holds the kebabs, by 90°.

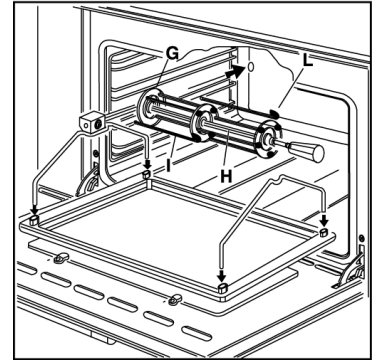
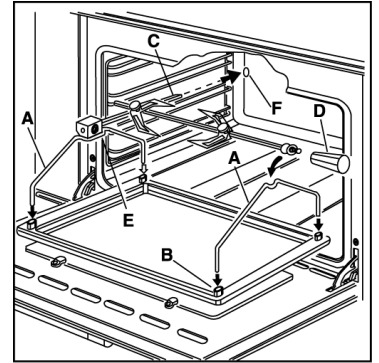

6.8 Defrosting

Turn the function switch knob to position , turn the thermostat knob to position "0": in this way the motor fan is activated, which circulates the air inside the oven and assists frozen food to defrost.

6.9 Switching off the oven

The oven is switched off by returning the thermostat knob to position "0".

6.10 Storage Drawer

The cookers are fitted with a storage drawer below the oven. Only store the cooker's metallic accessories in the storage drawer.

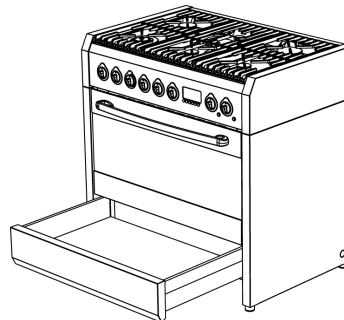

Do not store inflammable material such as cloths, paper or similar in the storage drawer.



7. Cooking suggestions

7.1 Suggestions for using the hob burners correctly

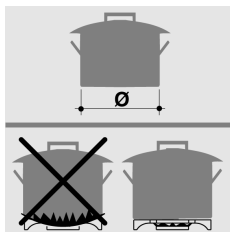

The diameter of the base of cooking utensils should fit the diameter of the burner used (see adjacent table). The burner flame must never be wider than the diameter of the utensils. Use utensils with a flat base. Where possible use pots with a lid, as this allows less power to be used. To reduce cooking times for vegetables, potatoes, etc., use a small amount of water.

Burner	Utensil diameter (in cm)
Rapid	from 24 to 26
Semi rapid	from 16 to 22
Auxiliary	from 8 to 14
Triple-ring	from 24 to 26
Fish kettle	from 16 to 35

7.2 Suggestions for using the ceramic hob correctly

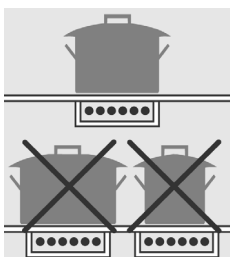

In order to obtain maximum efficiency and efficient consumption, it is essential to use only utensils that are suitable for use on a ceramic hob. The diameter of the base of the utensil must be the same as the diameter of the outline of the cooking area. Energy is wasted if they are not the same. The base of the utensil must be very thick and perfectly flat. It should also be clean and dry, as should the glass on the hob.

Do not use cast iron pots or pots with a rough base, as they may scratch the surface.

7.3 Suggestions for using the oven correctly



The oven is multifunction. It is possible to cook traditionally, with convection and with the grill.

The oven door should be completely closed for all types of cooking including grilling.

7.3.1 Traditional cooking

With this type of cooking, the heat comes from the top and the bottom. It is therefore preferable to use the central guides. If the cooking requires a hotter temperature from the bottom or from the top, use the lower or upper guides. Traditional cooking is recommended for all food that requires high cooking temperatures, or long braising times. This system is also recommended when cooking with **dishes** made of terracotta, porcelain and similar materials.

7.3.2 Convection cooking

With this type of cooking, the food is heated by preheated air that is circulated in the oven thanks to a fan located on the rear wall of the oven. Heat rapidly and evenly reaches all parts of the oven, thus enabling different food to be cooked at the same time on different shelves. Humidity is eliminated from the air and the drier area prevents odours and flavours from being spread and mixed. The possibility of cooking on more than one shelf allows you to cook many different dishes at the same time. Biscuits and mini pizzas can be cooked in three different baking tins. The oven, however, can also be used for cooking on a single shelf. The lower shelves can be used so that it is easier to monitor cooking.

Convection cooking is particularly convenient for bringing frozen food rapidly back to room temperature, for sterilising preserves or home-made fruit in syrup and, finally, for drying mushrooms or fruit.



7.3.3 Cooking with the grill

The heat comes from the top. Almost all meat can be grilled, with the exception of lean game and dishes such as meat-loaf. Meat and fish to be grilled should be lightly drizzled with oil and placed on the grid bars, which should be placed in the guides closest to or **furthest** away from the grill element, depending on the thickness of the meat, so as to avoid burning the surface and cooking too little inside.

Suitable for: relatively thin meat; toasted sandwiches.



*Pour 1 or 2 glasses of water into the dripping pan to avoid smoke forming due to **splashes** of juice or fat.*

While cooking with the grill, the dripping pan should always be positioned in the 1st guide from the bottom.

7.3.4 Cooking with the ventilated grill

Using the combination of grill and fan .

This type of cooking allows the heat to penetrate gradually inside the food, even though the surface is directly exposed to the grill.

Suitable for: thicker meat; game-birds.

7.3.5 Cooking meat and fish

Meat to be cooked in the oven should weigh at least **1 kg**. Very tender red meat to be cooked rare (roast beef, fillet, etc.), or which should be well cooked on the outside and preserve all its juices on the inside, require cooking on high temperatures for a short time (**200-250°C**). White meat, game-birds and fish require cooking on low temperatures (**150-175°C**).

The ingredients for the sauce should only be placed in the baking tin if the cooking time is short, otherwise, they should be added in the last half hour. Meat can be placed on an ovenproof plate or directly on the grid bars, below which the dripping pan should be placed to collect the juice. Press the meat with a spoon to check if it is done. If it is firm, it is cooked.

At the end of the cooking, wait at least **15 minutes** before cutting the meat so as not to lose the juices. Before serving, plates can be warmed in the oven at minimum temperature.

7.3.6 Baking

Beaten mixtures must adhere to the spoon because excess fluidity would prolong the cooking time. Sweets require moderate temperatures (generally between **150-200°C**) and require preheating (**approximately 10 minutes**). The oven door must not be opened until at least $\frac{3}{4}$ of the way through the cooking time.



7.3.7 Recommended cooking tables

Cooking times vary according to the nature, type and quantity of the food. We recommend monitoring your first attempts and checking the results, as similar results are obtained by cooking the same dishes in the same conditions. The following three tables (I, II and III) provide guidelines.

TABLE OF CONVECTION AND TRADITIONAL COOKING TIMES (I)

TYPE OF COOKING	QUANTITY KG.	POSITION OF GUIDE FROM BOTTOM		TEMPERATURE °C		TIME IN MINUTES
		CONVECTION 	TRADITIONAL 	CONVECTION 	TRADITIONAL 	
BAKING						
WITH BEATEN MIXTURE, IN A TIN	1	1-3	2	175	200	60
WITH BEATEN MIXTURE, ON THE DRIPPING PAN	1	1-3	2	175	200	50
SHORT PASTRY, PIE BASE	0.5	1-3	3	175	200	30
SHORT PASTRY WITH MOIST FILLING	1.5	1-3	2	175	200	70
SHORT PASTRY WITH DRY FILLING	1	1-3	2	175	200	45
MIXTURE WITH NATURAL LEAVENING	1	1-3	1	175	200	50
SMALL CAKES	0.5	1-3	3	160	175	30
MEAT						
VEAL	1	2	2	180	200	60
BEEF	1	2	2	180	200	70
ENGLISH STYLE ROAST BEEF	1	2	2	220	220	50
PORK	1	2	2	180	200	70
CHICKEN	1-1.5	2	2	200	200	70
STEWES						
BEEF STEW	1	1	2	175	200	120
VEAL STEW	1	1	2	175	200	110
FISH						
FILLET, STEAK, COD, HAKE, SOLE	1	1-3	2	180	180	30
MACKEREL, TURBOT, SALMON	1	1-3	2	180	180	45
OYSTERS	1	1-3	2	180	180	20
TIMBALE						
PASTA TIMBALE	2	1-3	2	185	200	60
VEGETABLE TIMBALE	2	1-3	2	185	200	50
SWEET AND SAVOURY SOUFFLÉS	0.75	1-3	2	180	200	50
PIZZA AND CALZONE	0.5	1-3	2	200	220	30

- The times refer to cooking on one shelf only; for more than one shelf increase the time by **5-10'**.
- The cooking times do not include preheating which takes **approximately 15'**.
- When cooking on more than one shelf, the guides are given in the preferential position.
- For beef, veal, pork and turkey roasts, either with bone or rolled, increase the time by **20'**.

TABLE OF COOKING TIMES WITH GRILL AND VENTILATED GRILL (II)

TRADITIONAL GRILLING				
TYPE OF COOKING	QUANTITY KG.	POSITION OF GUIDE FROM BOTTOM	TEMPERATURE °C	TIME IN MINUTES
CHICKEN	1-1.5	3	MAX	30 PER SIDE
TOASTED SANDWICHES	0.5	4	MAX	5 PER SIDE
SAUSAGES	0.5	4	MAX	10 PER SIDE
PORK CHOPS	0.5	4	MAX	8 PER SIDE
FISH	0.5	4	MAX	8 PER SIDE
GRILLING WITH VENTILATED GRILL				
TYPE OF COOKING	QUANTITY KG.	POSITION OF GUIDE FROM BOTTOM	TEMPERATURE °C	TIME IN MINUTES
ROAST PORK	1.5	2	170	180
ROAST BEEF	1.5	3	220	60
CHICKEN	1.2	2	190	90

- The dripping pan for collecting cooking juices should always be positioned in the **1st guide from the bottom**.

TABLE OF DEFROSTING TIMES (III)

DEFROSTING			
TYPE OF FOOD	QUANTITY KG.	POSITION OF GUIDE FROM BOTTOM	TIME IN MINUTES
READY-TO-EAT DISHES	1	2	45
MEAT	0.5	2	50
MEAT	0.75	2	70
MEAT	1	2	110

- Defrosting at room temperature has the advantage of not modifying the flavour and appearance of food.



8. Cleaning and maintenance



Before cleaning or carrying out maintenance, switch off the power supply to the appliance and close the gas tap.



Do not clean the surfaces of the appliance when they are still hot.

8.1 Cleaning stainless steel surfaces



To clean and preserve the stainless steel surfaces and remove the toughest stains, always use specific products, provided **they do not contain chlorine-based abrasives or acid substances**, or a little warm vinegar.

Pour the product onto a damp cloth and wipe the steel surface. Rinse carefully and dry with a soft cloth or a piece of deerskin.

Do not under any circumstances use metallic sponges or sharp scrapers that may damage the surfaces. Only use non-scratch, non-abrasive sponges and, if necessary, wooden or plastic utensils.

8.2 Cleaning enamelled surfaces

Clean with a non-scratch, **non-abrasive** sponge dampened with soap and water. Grease stains can easily be eliminated with hot water or a product specifically made for cleaning enamel. Rinse carefully and dry with a soft cloth or a piece of deerskin.

Do not use products containing abrasives, scouring pads, steel wool or acid, which may spoil the surfaces. Do not leave acid or alkaline substances on the enamel (lemon juice, vinegar, salt, etc.).

8.3 Cleaning the knobs and the control panel

Clean the knobs and the control panel with a damp cloth.

8.4 Cleaning the grids and burners

To clean the grids and hob burners, remove them from their housing by lifting them upwards as shown in the figure, and immerse them in a solution of warm water and **non-abrasive** detergent for about ten minutes. Rinse and dry carefully.

Always check that none of the burner openings is clogged.

Be sure to refit the burner correctly, checking the flame is uniform.

We recommend carrying out this operation at least once a week and each time it is necessary.

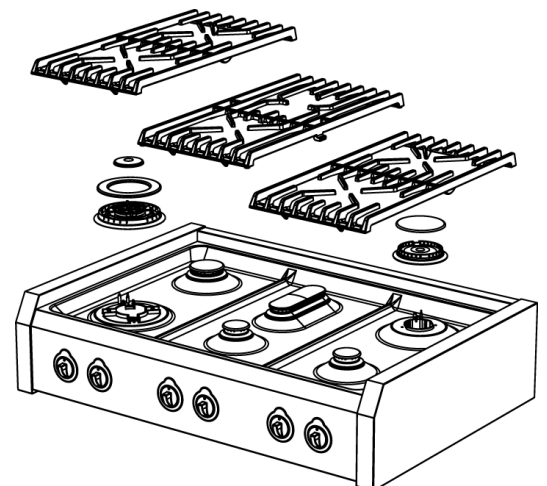



8.5 Cleaning the igniter plugs and thermocouples

In order for the igniter plugs and thermocouples to operate correctly, they must be kept clean at all times. Check them frequently and, if necessary, clean them with a damp cloth. Any dry residue should be removed with a toothpick or needle, **taking care not to damage the insulating ceramic part.**

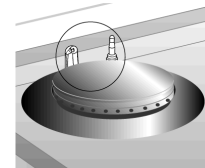

8.6 Cleaning the ceramic hob

The ceramic hob must be cleaned regularly, each time it is used if possible, when the latent heat lights are off.

Any light-coloured marks caused by aluminium-based pans can be removed with a damp cloth dipped in vinegar.

Any burnt residue left after cooking can be removed with a wooden spatula. Rinse with water and dry well with a clean cloth.

Do not under any circumstances use **abrasive or corrosive** detergents (e.g. powder products, oven sprays, stain-removers or metallic sponges).

Any grease deposits on the ceramic hob can be removed more easily by heating it for approximately **20-30 minutes** (knob in position 11). Afterwards, this residue can be cleaned off with a wooden spatula. Allow the surface to cool, rinse with water and dry well with a clean cloth.

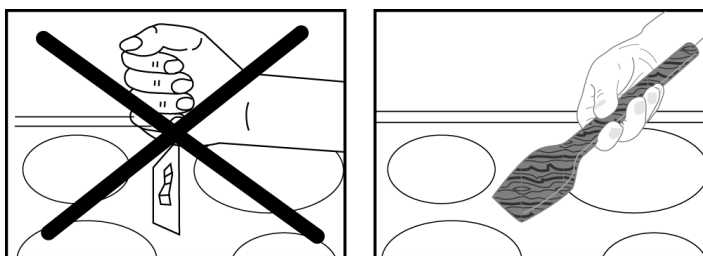

*The cooking surface of the ceramic hob is extremely resistant. It is not however unbreakable and may be damaged, above all by pointed or hard objects if dropped onto it with a certain force. **Do not use the ceramic hob if the surface is broken, cracked or split! Contact your local Service Force Centre immediately.***

8.7 Cleaning the oven

Clean the oven regularly, each time it is used if possible, **after leaving it to cool**: in this way it is possible to remove any residue more easily, preventing it from burning the next time the oven is used.

Clean the stainless steel parts and enamelled parts as described in the corresponding sections "8.1 Cleaning stainless steel surfaces" and "8.2 Cleaning enamelled surfaces".

Take out all the removable parts and wash them separately. Rinse and dry thoroughly with a clean cloth.

8.7.1 Cleaning the oven door

We recommend always keeping the oven door clean. Use kitchen roll and on tougher dirt use a damp cloth and household detergent.



Spray products for cleaning the oven must not be used to clean the fan and the thermostat sensor inside the oven compartment.



9. Special maintenance

Periodically, it is necessary to maintain or replace some parts that are subject to wear and tear. Specific instructions are given below for each type of maintenance.



Before carrying out maintenance, switch off the power supply to the appliance and close the gas tap.

9.1 Removing the oven door

In order to clean the oven door more thoroughly, we recommend removing it as follows:

- open the door completely;
- hook the rings **A** onto the appropriate seats in the hinges (**Fig. A**);
- lift the door slightly and remove it (**Fig. B**);
- place the door on a horizontal surface;
- unscrew the screw **B** using a screwdriver and remove the tab **C** (**Fig. C**);
- clean the glass **D** (**Fig. C**) and door components as described in section “8.7.1 Cleaning the oven door”;
- afterwards, follow the removal instructions in reverse order.

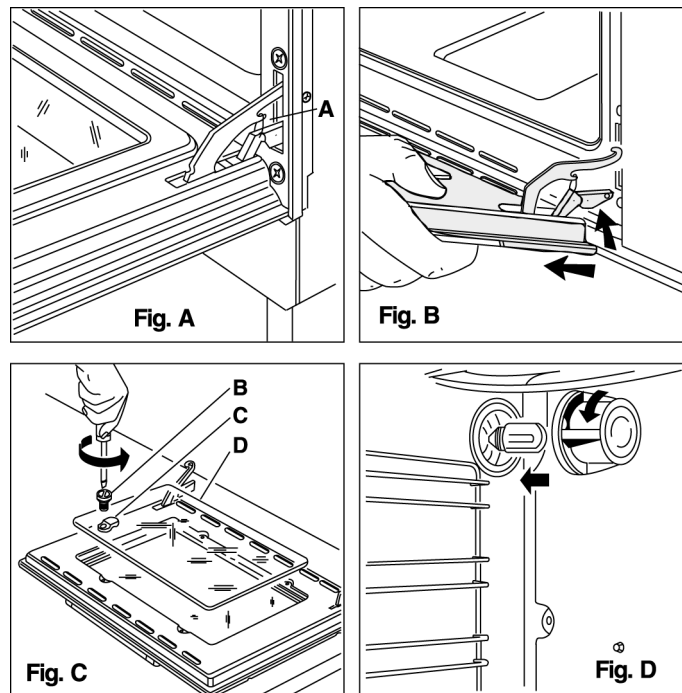

9.2 Replacing the oven light bulb

Proceed as follows:

- open the oven door;
- unscrew the glass safety cap anticlockwise (**Fig. D**); unscrew the bulb and replace it with another one for **high temperatures (300°C)** with the following characteristics:

Voltage: 230 V / 50 Hz

Power: 15 W

Attachment: E 14

- Refit the glass cap and switch on the power. It is possible to check that the oven light is working even when the door is closed by turning the function switch knob to position ☼.



10. Service and Spare Parts

If you wish to purchase spare parts or require an engineer, contact your local AEG Service Force Centre by telephoning:

08705 929 929

Your telephone call will be automatically routed to the Service Force Centre covering your post code area.

For the address of your local Service Force Centre and further information about Service Force, please visit the website at **www.serviceforce.co.uk**

When you contact the Service Centre they will need the following information:

1. Your name & address, including post code.
2. Your telephone number.
3. Clear and concise details of the fault.
4. The model and serial number of the appliance (found on the rating plate).
5. The purchase date.

Please note that a valid purchase receipt or guarantee documentation is required for in-guarantee service calls.

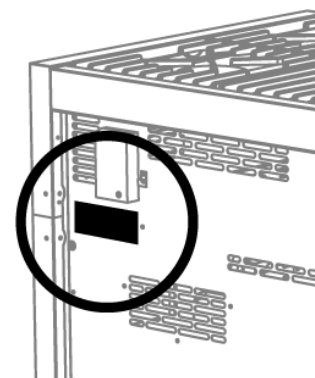

10.1 Customer Care

For general enquiries concerning your AEG appliance or for further information on AEG products please contact our Customer Care Department by letter or telephone at the address below or visit our website at **www.aeg.co.uk**.

Customer Care Department
AEG Domestic Appliances
55-77 High Street
Slough
Berkshire, SL1 1DZ
Tel. 08705 350350 (*)

(*) Calls may be recorded for training purposes.



11. Guarantee Conditions

11.1 Standard guarantee conditions

We, AEG, undertake that if within 12 months of the date of the purchase this AEG appliance or any part thereof is proved to be defective by reason only of faulty workmanship or materials, we will, at our discretion repair or replace the same FREE OF CHARGE for labour, materials or carriage on condition that:

- The appliance has been correctly installed and used only on the electricity or gas supply stated on the rating plate.
- The appliance has been used for normal domestic purposes only, and in accordance with the manufacturer's operating and maintenance instructions.
- The appliance has not been serviced, maintained, repaired, taken apart or tampered with by any person not authorised by us.
- All service work under this guarantee must be undertaken by a Service Force Centre. Any appliance or defective part replaced shall become the Company's property.
- This guarantee is in addition to your statutory and other legal rights.
- Home visits are made between 8.30am and 5.30pm Monday to Friday. Visits may be available outside these hours in which case a premium will be charged.

11.2 Exclusions

This guarantee does not cover:

- Damage or calls resulting from transportation, improper use or neglect, the replacement of any light bulbs or removable parts of glass or plastic.
- Costs incurred for calls to put right an appliance which is improperly installed or calls to appliances outside the United Kingdom.
- Appliances found to be in use within a commercial environment, plus those which are subject to rental agreements.
- Products of AEG manufacture which are not marketed by AEG.

11.3 European Guarantee

If you should move to another country within Europe then your guarantee moves with you to your new home subject to the following qualifications:

- The guarantee starts from the date you first purchased your product.
- The guarantee is for the same period and to the same extent for labour and parts as exists in the new country of use for this brand or range of products.
- This guarantee relates to you and cannot be transferred to another user.
- Your new home is within the European Community (EC) or European Free Trade Area.
- The product is installed and used in accordance with our instructions and is only used domestically, i.e. a normal household.
- The product is installed taking into account regulations in your new country.

Before you move please contact your nearest Customer Care centre, listed below, to give them details of your new home. They will then ensure that the local Service Organisation is aware of your move and able to look after you and your appliances.

France	Senlis	+33 (0) 3 44 62 29 29
Germany	Nürnberg	+49 (0) 800 234 7378
Italy	Pordenone	+39 (0) 800 117511
Sweden	Stockholm	+46 (0) 8 672 5360
UK	Slough	+44 (0) 1753 219899



12. Installation

DIMENSIONS OF THE COOKERS

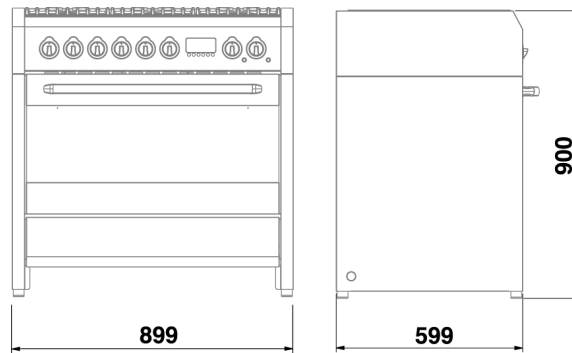

12.1 General warnings



It is the law that a competent person installs all gas appliances. In the UK Corgi gas installers are approved to work to safe and satisfactory standards. The cooker must be installed in accordance with BS 6172. Failure to install the cooker correctly could invalidate the warranty liability claims could and could lead to prosecution.

The manufacturer declines any responsibility for damage incurred by persons, animals or objects that is caused by not following the above guidelines (chapter “1. Warnings for safety and use”).

The technical data is indicated on the plate located on the back of the appliance. The adjustment conditions are shown on a label applied to the packing and the appliance.

Do not use the oven door handle for handling the appliance, or for removing the appliance from the packing.

12.2 Electric connection

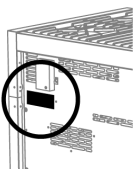

Make sure that the voltage and the current capacity of the mains corresponds to the specifications shown on the rating plate located on the back of the appliance.

The rating plate must never be removed.

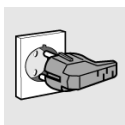

The plug at the end of the power supply cable and the wall socket must be the same type and must comply with current electric standards. Check that the mains is adequately earthed. The power supply cable should conform to BS6004.



Prepare a double pole isolating device on the power supply line of the appliance with a contact opening distance equal to or more than **3 mm**, located in a convenient position near the appliance.

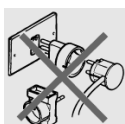

Do not use adapters or extension cables.



Before making the electric connection, make sure of the safety of the earth.

Make sure that the fuse and the home wiring system are able to withstand the appliance load.

The yellow/green earth cable must not be interrupted at any point.

The electric cable must not come into contact with parts whose temperature is more than **50°C** higher than room temperature.

The cooker should be installed in accordance with the latest edition of the IEE regulations.

12.2.1 Electric power cable section

According to the type of power supply, use a cable that conforms to the following diagram.

The end to be connected to the appliance must have the earth wire (**yellow-green**) at least **20 mm** longer.

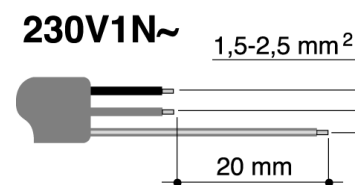

12.2.2 Type of power supply

It is possible to obtain different connections according to the mains voltage by connecting the mains cable to the terminal board as shown in the following diagram.

MODEL	POWER kW
VITROCERAMIC HOB	9,7
COOKER 6 BURNERS (1 OVEN)	2,9

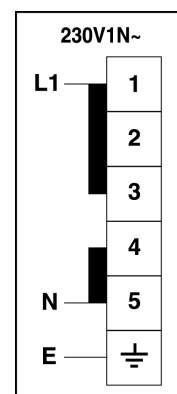

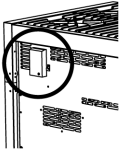

12.2.3 Replacing the electric cable

To replace the electric cable, it is necessary to access the terminal board. It is located on the back of the appliance, at the top left, as shown in the figure.

To replace the cable, proceed as follows:

- open the terminal board box;
- unscrew the screw **A** that locks the cable;
- loosen the screw contacts and replace the cable with one of the same length that corresponds to the specifications in the table in section "12.2.1 Electric power cable section";
- the "yellow-green" earth wire must be connected to the terminal \oplus and must be approximately **20 mm** longer than the line cables;
- the neutral "blue" wire must be connected to the terminal marked with the letter **N**;
- the live "brown" must be connected to the terminal marked with the letter **L**.

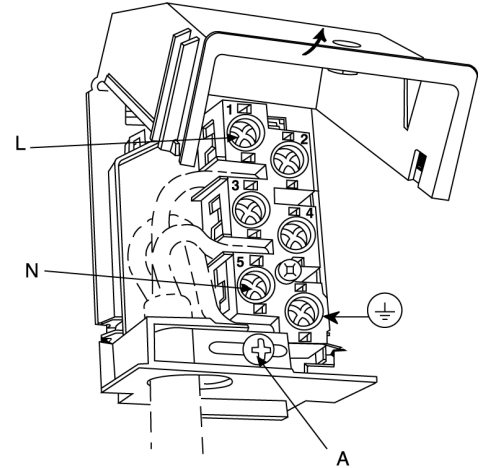

12.3 Power consumption of the ceramic hob

The ceramic hob has different power consumptions depending on the type of heating element used. The diagram shows the values of the power consumed.

In the envisaged cases, the first numeric value refers to the total power, whereas the value that follows the symbol "/" refers to the inside diameter, with the exception of the central heating element, whose value that follows "/" refers to the outer diameter.

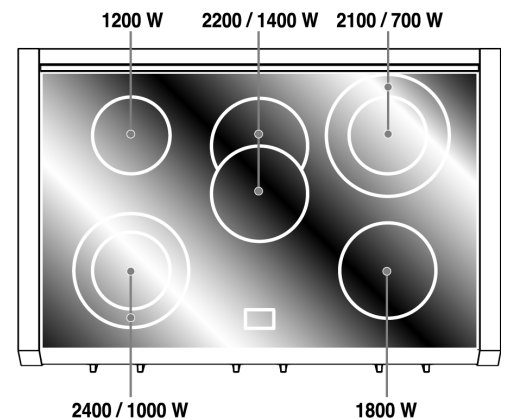

12.4 Ventilation requirements

The room containing the appliances should have an air supply in accordance with B.S. 5440 part 2.

1. All rooms require an opening window or equivalent, and some rooms will require a permanent vent as well.
2. For room volumes up to 5m³ an air vent of 100cm² is required.
3. If the room has a door that opens directly to the outside, and the room exceeds 1m³ no air vent is required.
4. For room volumes between 5m³ and 10m³ an air vent of 50cm² is required.
5. If there are other fuel burning appliances in the same room B.S. 5440 part 2 should be consulted to determine the air vent requirements.
6. The appliance must not be installed in a bed sitting room of less than 20m or in a bathroom or shower room.



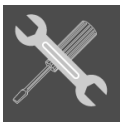

Windows and permanent vents should therefore not be blocked or removed without first consulting a Corgi gas installer.

Failure to install appliances correctly is dangerous and could lead to prosecution.



L.P.G. cookers *MUST NOT* be installed below ground level i.e. in a basement or aboard any boat, yacht or other vessel.

12.5 Gas connection

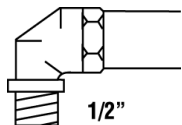

We recommend checking that the appliance is properly set up for the type of gas distributed. The threaded 1/2" gas connection pipe is located at the rear on the right hand side of the appliance.

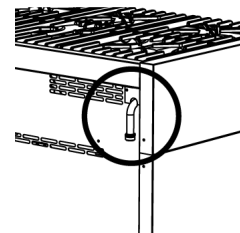

The cooker is designed to match the depth of standard 600mm worktops. A bayonet connector should, therefore, be fitted within the shaded area shown to allow the cooker to be pushed in fully and secured to the wall with a stability chain.

Connection to the cooker should be made with an approved appliance flexible connection to BS 669. A length of 0.9 to 1.25m is recommended. The length of hose chosen should be such that when the cooker is in position, the hose does not touch the floor.

The temperature rise of areas at the rear of the cooker that are likely to come in contact with the flexible hose do not exceed 70°C.

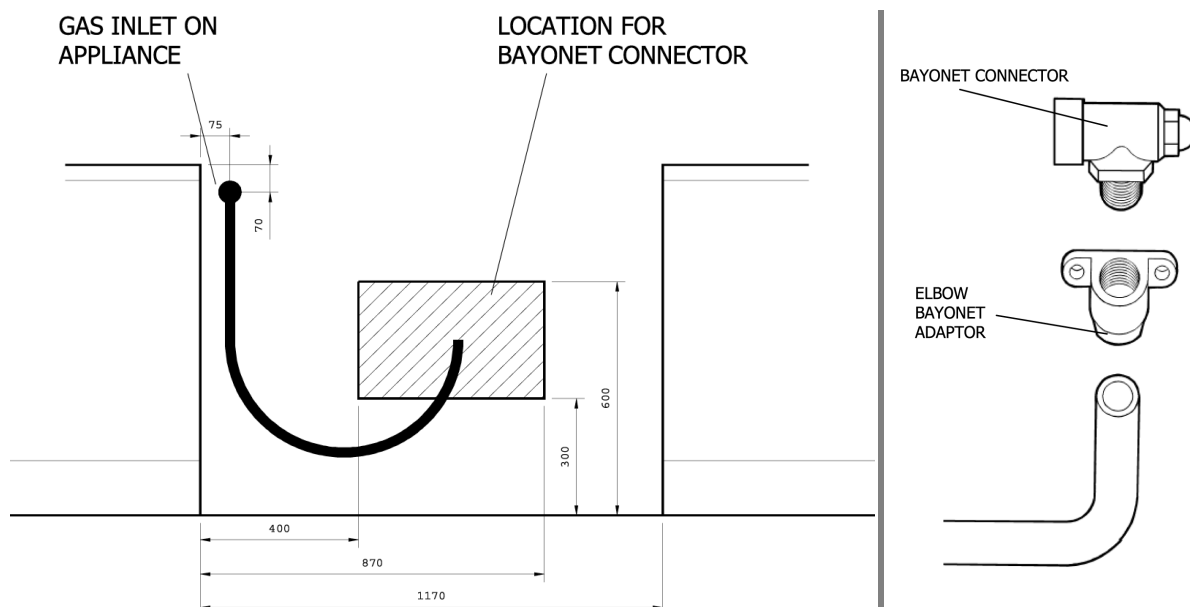



12.6 Stability chain

The cooker is fitted with a stability device such as a proprietary stability chain as shown and firmly secured to the fabric of the building.

Whatever the position, remember to leave enough room for the cooker to be pulled out for cleaning and service.

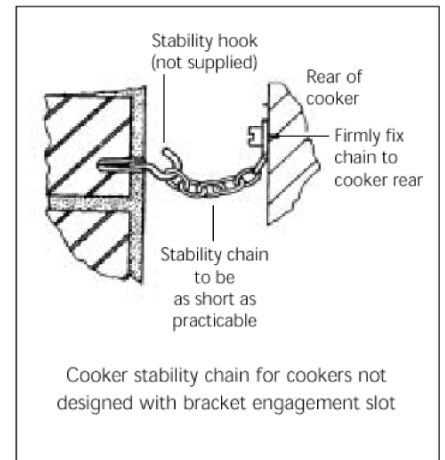

The wall behind the cooker between the hotplate and 450mm above, and across the width of the cooker, must be an incombustible material such as ceramic wall tiles.

This appliance is designed not to project in front of standard 600mm worktops (excluding handles). To achieve the best fit the cooker must be pushed against the wall.

As this appliance is very heavy it should be situated on a suitably hard surface as to ensure servicing and installation is made possible with minimal impact on the floor surface.

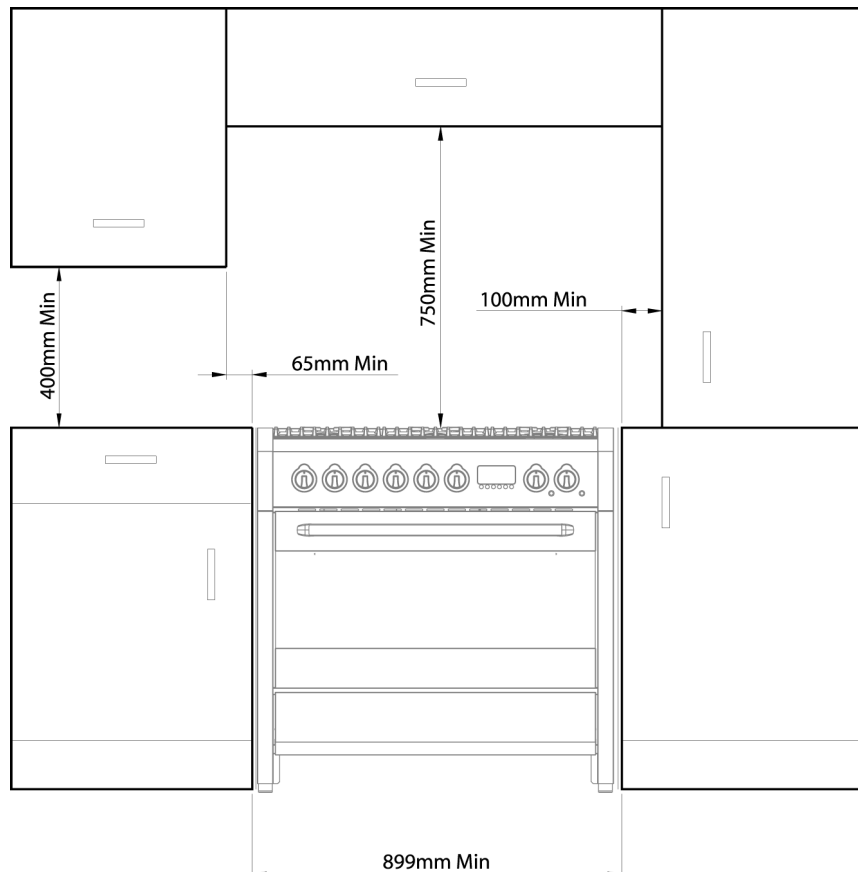



12.7 Gas regulations

If the cooking appliance is set up for a **different** type of gas than that available, its injectors must be replaced, the minimum flow regulated. In order to replace the injectors in the cooking hob, it is necessary to carry out the following operations:

- remove the pan supports;
- remove the burners and burner caps (**Fig. A**);
- take out the injector (**Fig. B**) and replace it with one suitable for the new type of gas (see "**GENERAL INJECTORS TABLE**");
- refit all parts by following the disassembly instructions in reverse order and taking care to position the burner cap correctly on the burner.

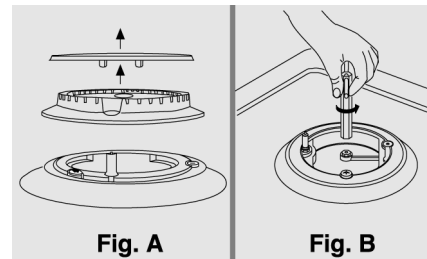

12.7.1 Minimum flow of valved cooking hob taps

- Switch on the burner and turn the control knob towards the minimum flow position ϕ ;
- remove the knob;
- using a screwdriver, adjust the internal screw **Z** until the correct low flame is obtained;
- refit the knob.

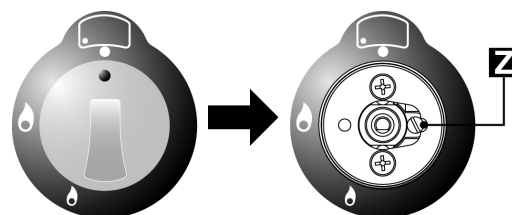

12.7.2 Minimum flow of non-valved cooking hob taps

- Switch on the burner and turn the control knob towards the minimum flow position ϕ ;
- remove the knob;
- insert a small screwdriver into the rod of the tap and adjust the internal screw **Z** until the correct low flame is obtained;
- refit the knob.

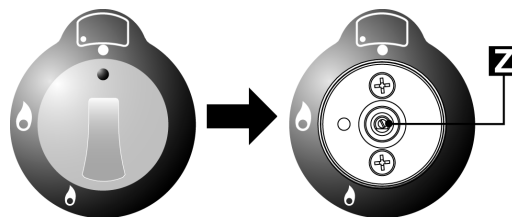

- *Unscrew the adjustment screw **Z** to increase the flow, or tighten it to reduce the flow.*
- *The adjustment is correct when the low flame measures approximately 3 or 4 mm.*
- *When changing quickly from maximum to minimum flow and vice versa **make sure that the flame does not go out.***

GENERAL INJECTORS TABLE

TYPE OF GAS	Mbar	NOZZLE NO.	BURNERS POSITION TYPE	POWER Watt		CONSUMPTION
				MAX.	MIN.	MAX.
NATURAL GAS	20	115	RAPID	3000	750	286 l/h
		97	SEMI RAPID	1750	480	167 l/h
		72	AUXILIARY	1000	330	95 l/h
		128	TRIPLE-RING	3300	1300	298 l/h
		94	FISH KETTLE	1900	750	181 l/h
LPG BUTANE PROPANE	30 28 37	85	RAPID	3000	750	219 g/h
		65	SEMI RAPID	1750	480	128 g/h
		50	AUXILIARY	1000	330	73 g/h
		93	TRIPLE-RING	3300	1300	241 g/h
		68	FISH KETTLE	1900	750	138 g/h

12.8 Connecting to LPG

Use a pressure regulator and connect to the cylinder in compliance with the guidelines set out in standards regulations in force.

Note: L.P.G. cookers **MUST NOT** be installed below ground level i.e. in a basement or aboard any boat, yacht or other vessel.

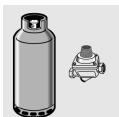



13. Final operations



Make sure that the gas pipes and electric cables are not crushed or obstructed.

13.1 Positioning and levelling the cooker

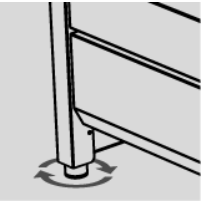

After connecting the gas pipes and electric cables, level the cooker using the four adjustable feet.

 **From the Electrolux Group. The world's No. 1 choice.**

The Electrolux Group is the world's largest producer of powered appliances for kitchen, cleaning and outdoor use. More than 55 million Electrolux Group products (such as refrigerators, cookers, washing machines, vacuum cleaners, chain saws and lawn mowers) are sold each year to a value of approx. USD 14 billion in more than 150 countries around the world.