

Pocket PC Phone

Quick Start Guide

www.htc.com



Contents

1. What's in the Box?	3
2. The Pocket PC Phone	4
3. Getting Ready.....	8
4. Making a Call	13
5. Synchronizing Outlook Information	14
6. Setting Up E-mail Accounts	16
7. Sending a Message	18
8. Browsing the Internet	19
9. Using the Camera	20
10. Using Pictures & Videos	21
11. Music Entertainment	23
12. Entering Information	28
13. Status Indicators	29
14. Customizing Your Pocket PC Phone.....	32
15. Securing Your Pocket PC Phone	33
16. More Information	34

1. What's in the Box?



2. The Pocket PC Phone

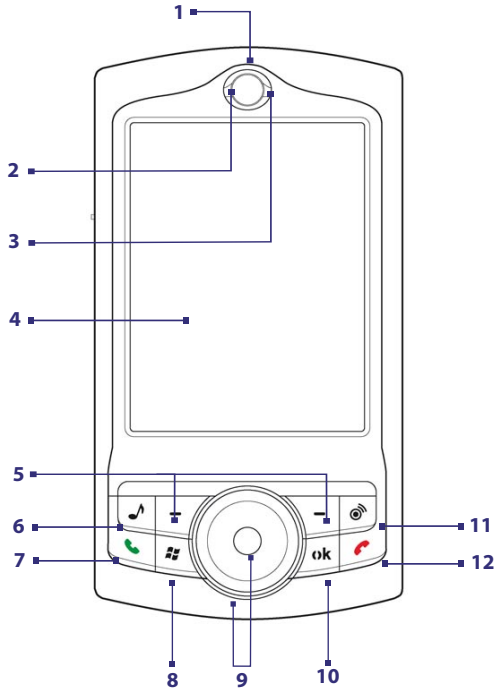

No.	Item	Function
1	Earpiece	Listen to phone call from here.
2	Notification LED 1	This LED shows the following: <ul style="list-style-type: none"> • A blinking Blue light for Bluetooth system notification of powered-up and ready to transmit Bluetooth signal. • A blinking Green light for Wi-Fi status. • When both Bluetooth and Wi-Fi are enabled, their lights blink alternately.
3	Notification LED 2	This LED shows Green and Amber lights for GSM/GPRS/EDGE standby, message, and network status as well as for notification and battery charging status.
4	Touch Screen	Tap the screen with the stylus to write, draw, or make a selection.
5	Left and Right SOFT KEYS	Press to execute the command shown in the label above the button.
6	MEDIA HUB Button	Press to open Media Hub, a program launcher that gives you quick access to multimedia programs on your device.
7	TALK Button	Press to answer an incoming call or dial a number.
8	START Button	Press to open the Start menu.
9	HTC RollR™	HTC RollR™ is a proprietary device control that integrates the use of the Track Wheel and Trackball. Use it for scrolling, web browsing, camera zoom control and shutter release, and for mouse movement when in mouse mode. <p>Track Wheel</p> <ul style="list-style-type: none"> • Turn clockwise or counterclockwise to move through items on the screen or in a menu. • When using the Camera, use it for zooming. <p>Trackball</p> <ul style="list-style-type: none"> • Roll up, down, left, or right to move through menus and program instructions; carry out the selection by pressing the Trackball. • When using the Camera, use it as the shutter release.
10	OK Button	Press to confirm your data entries, or to exit the program in use.
11	COMM MANAGER Button	Press to launch Comm Manager. Comm Manager lets you easily turn on/off your device's connections (such as Bluetooth and Wi-Fi), ringer, phone, etc.
12	END Button	Press to end a call or to return to the Today screen.

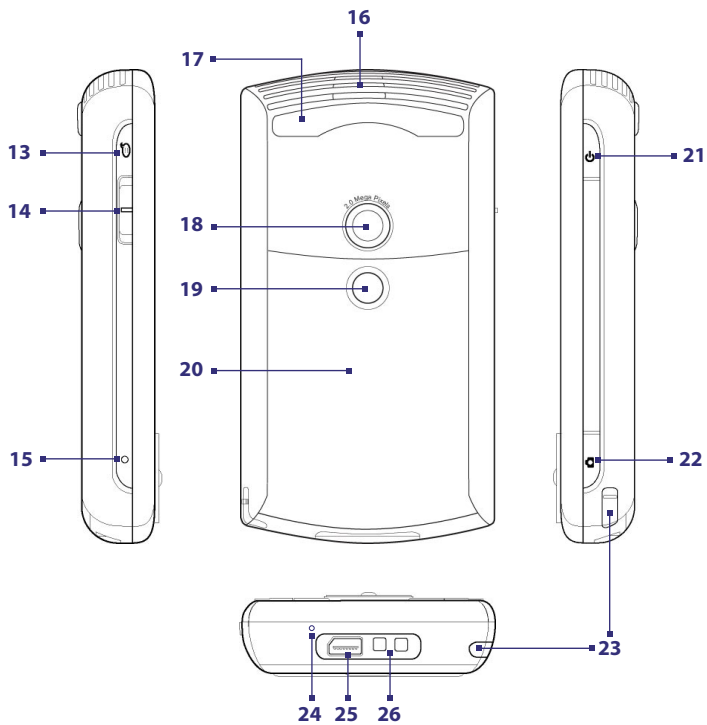

No.	Item	Function
13	VOICE COMMAND Button	Press to start Voice Speed Dial; press and hold to record a voice note.
14	Volume Slider	<ul style="list-style-type: none">• Slide up or down to adjust the speaker volume.• During a call, slide up or down to adjust the earpiece volume.
15	RESET Button	With the stylus, press the RESET button to soft-reset your device.
16	Speaker	Listen to media from here.
17	Car Antenna Connector	Connect your device to the car antenna while in a car to have better reception quality.
18	Camera	Use the camera to take still photos and record video clips.
19	Self-Portrait Mirror	Turn the back side of your device to face yourself so that your image reflects on the mirror when taking self-portrait shots.
20	Battery Cover	Slide out to access the battery compartment.
21	POWER Button	<ul style="list-style-type: none">• Press and hold to turn on the device.• Press to turn off the display temporarily. This switches your device to Sleep mode. You can still receive calls and messages when your device is in Sleep mode.• Press and hold (for about 5 seconds) to turn off the power completely. All functions including the phone will be unavailable for use.
22	CAMERA Button	Press to launch the Camera; press again to take a photo or video clip, depending on the specified capture mode.
23	Stylus	Use the stylus to write, draw, or select items on the touch screen.
24	Microphone	Speak into the microphone when receiving or making a phone call or voice recording.
25	Sync Connector/ Earphone Jack	Use this connector to synchronize data by connecting the provided USB Sync cable or to recharge the battery via the provided AC adapter. You can also connect the provided USB stereo headset for hands-free conversation or for listening to FM radio and audio media. FM radio uses the stereo headset as an antenna.
26	Strap Holder	Attach a strap for carrying your device.

No.	Accessory	Function
1	AC adapter	Recharges the battery.
2	USB Sync cable	Connects your device to a PC and synchronizes data.
3	Stereo headset	<ul style="list-style-type: none">• Provides a volume control slider and a Send/End button. Press the Send/End button to pick up a call or put a call on hold; press and hold the button to end the call.• Make sure you connect this headset when using the FM Radio since it uses the headset as an antenna.

3. Getting Ready

Before you start using your device, you must install a SIM card and a charged battery. The SIM card contains your phone number and service details, and it stores phonebook entries and your messages.

If you need more storage for your device, you can also insert a microSD™ card inside the battery compartment. Insert the microSD™ card first before the SIM card, since the storage card slot is located underneath the SIM card slot.

Install the storage card and SIM card

1. Make sure your device is turned off.
2. Slide out the battery cover. If the battery is inside, remove by lifting it up from the upper right side of the battery slot using your finger.
3. Slide the SIM card holder downward to unlock it, then lightly flip it open.
4. Pry open the storage card holder.
5. Insert the microSD™ card and the SIM card into the respective card holders, with their gold contacts facing down. (The cut-off corner of the SIM card should match the cut-off corner in the SIM card slot).

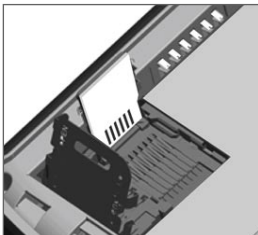

Inserting the microSD™ card

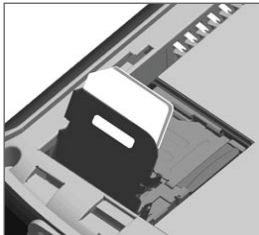

Inserting the SIM card

6. Press down the storage card holder to close and lock it in place.
7. Close the SIM card holder, then slide it upward to lock it in place.
8. Replace the battery (see instructions in the next section).
9. Replace the battery cover.

Install and charge the battery

New batteries are partially charged. Before you start using your device, it is recommended that you install and charge the battery.





To install the battery, remove the battery cover first, and then insert the battery by aligning the exposed copper part of the battery pack with the protruding copper conductor which is on the left side of the battery slot. Insert the left side of the battery first, then gently push the battery into place, and replace the battery cover.

Some batteries perform best after several full charge/discharge cycles. You can charge the battery in two ways:

- Connect your device directly to an electrical outlet using the AC adapter.
- Plug the sync cable to the USB port on your PC and to the sync connector on your device.



When your device is turned off, charging is indicated by a solid amber light on the LED indicator. When your device is turned on, charging is indicated by a solid amber light on the LED indicator as well as a charging icon () on the Quick Launcher.

After the battery has been fully charged, the LED indicator becomes green and a full battery icon () appears on the Quick Launcher.

Check the battery power

- Tap the battery level icon () on the Quick Launcher. The Power Settings screen will then open where you can see the current battery power level.

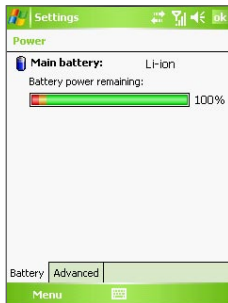

Battery power indicator

When the battery power gets very low, a warning message will be displayed. When you see this, immediately save your data by synchronizing with your PC, or save your data on a secondary storage card, and then turn off your device. Do not attempt to restart your device until you have connected it with the power adapter.

Turn on your Pocket PC Phone

Press and hold the POWER button to turn on your device. When you turn on your device for the first time, a Quick Start Wizard will guide you through the screen calibration process and the setup of regional settings, date and time, password, Outlook e-mail, and POP3/IMAP4 e-mail accounts.

To turn off your device, press and hold the POWER button for a few seconds. A message will then be displayed, prompting you whether or not to turn off the device completely.

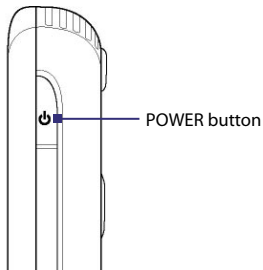

Switch your device to Sleep mode

Quickly pressing the POWER button turns off the display temporarily and switches your device to **Sleep mode**. Sleep mode suspends your device to a low power state while the display is off in order to save battery power. Your device also automatically goes into Sleep mode when you leave the device idle after a certain amount of time.

You will still be able to receive messages and calls while your device is in Sleep mode. Pressing the POWER button again or new incoming calls/messages will wake up your device.

4. Making a Call

Like a standard mobile phone, you can use your device to make, receive, and keep track of phone calls and send SMS messages.

The Phone screen

From the Phone screen, you can access Call History, Speed Dial, and Phone settings. To open the Phone screen, do one of the following:

- Use the stylus to tap **Start > Phone**.
- Press TALK on the device.

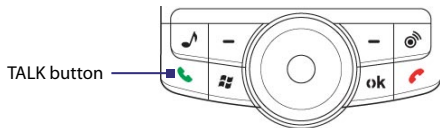

Make a voice call

- On the Phone screen, tap the phone number you want to call, then tap  or press the TALK button.

5. Synchronizing Outlook Information

Using Microsoft® ActiveSync®, you can synchronize information on your device with information on your PC, such as Outlook content. ActiveSync is already installed on your device, but you need to install it on your PC if you don't already have it. Insert the **Getting Started Disc** into the CD drive of your PC. Follow the instructions on the installation wizard screen to install ActiveSync. Once installation is completed, connect the sync cable to your device and plug it into your PC's USB port.

To set up a partnership between your device and the PC, turn on your device. When the PC detects a USB connection, it starts the **ActiveSync Synchronization Setup Wizard**. Follow the instructions on the screen and select the Outlook items you want to synchronize.

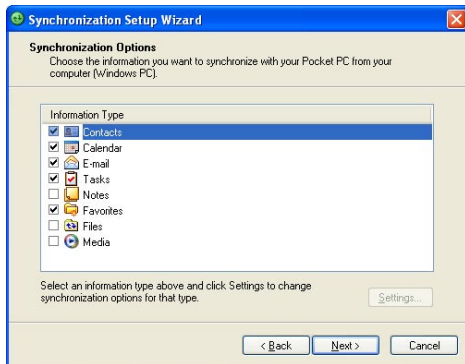

Synchronization Setup Wizard
(Synchronization Options)

PC requirement to run ActiveSync 4.x

To connect your device to the PC, you must have the Microsoft® ActiveSync® program installed on your PC. ActiveSync 4.x is included in the **Getting Started Disc**, which is compatible with the following operating systems and applications:

- Microsoft® Windows® 2000 Service Pack 4
- Microsoft® Windows® Server 2003 Service Pack 1
- Microsoft® Windows® Server 2003 IA64 Edition Service Pack 1
- Microsoft® Windows® Server 2003 x64 Edition Service Pack 1
- Microsoft® Windows® XP Professional Service Packs 1 and 2
- Microsoft® Windows® XP Home Service Packs 1 and 2
- Microsoft® Windows® XP Tablet PC Edition 2005
- Microsoft® Windows® XP Media Center Edition 2005
- Microsoft® Windows® XP Professional x64 Edition
- Microsoft® Outlook® 98, Microsoft® Outlook® 2000 and Microsoft® Outlook® XP, and Microsoft® Outlook® 2003 messaging and collaboration clients
- Microsoft® Office 97, excluding Outlook
- Microsoft® Office 2000
- Microsoft® Office XP
- Microsoft® Office 2003
- Microsoft® Internet Explorer 4.01 or later (required)
- Microsoft® Systems Management Server 2.0

6. Setting Up E-mail Accounts

The E-mail Setup Wizard makes it easy and simple to set up your Outlook e-mail and POP3/IMAP4 accounts on your device.

Set up e-mail accounts using E-mail Setup Wizard

1. Tap **Start > Messaging**.
2. Tap **Menu > Tools > New Account** to access the E-mail Setup Wizard.
3. The E-mail Setup Wizard guides you step-by-step through the setup process.

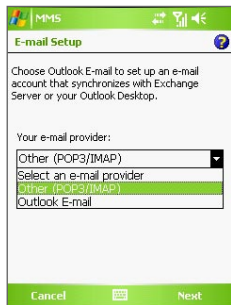

Set up Outlook e-mail

To be able to send and receive Outlook e-mail on your device, you must set up ActiveSync synchronization with your computer or the Exchange Server. For information about setting up ActiveSync synchronization, refer to the user manual.

Set up a POP3/IMAP4 e-mail account

Set up a POP3 or IMAP4 e-mail account on your device if you have an e-mail account with an Internet service provider (ISP) or an account that you access using a VPN server connection (typically a work account).

1. Tap **Start > Messaging**.
2. Tap **Menu > Tools > New Account**.
3. On the first E-mail Setup screen, select **Other (POP3/IMAP)** from the **Your e-mail provider** list, then tap **Next**.
4. On the next screen, enter your e-mail address, and tap **Next**.



Auto configuration will help you download necessary e-mail server settings.

5. Once Auto configuration has finished, tap **Next**.
6. Enter your name (the name you want displayed when you send e-mail) and your password.

Tip Select the **Save password** check box if you want to save your password so that you do not need to enter it again.

7. Sending a Message

Your device is capable of sending and receiving E-mail, SMS, and MMS messages as long as it is connected to the network. Although you can send text messages (SMS) to only mobile phone numbers, MMS messages can be sent to both mobile phone numbers and e-mail addresses.

Compose and send a message

1. In the message list, tap **Menu > Go To** and select an account.
2. Tap **New**.
3. Enter the e-mail address or mobile phone number of one or more recipients, separating them with a semicolon. To access addresses and phone numbers from Contacts, tap **To**.
4. Enter your message.
 - To quickly add common messages, tap **Menu > My Text** and tap a desired message.
 - To check the spelling, tap **Menu > Spell Check**.
5. Tap **Send**.

Note SMS and MMS can only be sent if your device is connected to a GSM/EDGE network. E-mail messages can be sent only if your device has Internet access (e.g. via GSM/EDGE/GPRS, USB/Bluetooth connection to computer, etc).



Composing Outlook e-mail message

8. Browsing the Internet

You can set up connections to the Internet or to a corporate network to browse the Internet. The pre-loaded browser, **Internet Explorer Mobile**, is a full-featured Internet browser, and optimized for use on your device.

Use Internet Explorer Mobile

1. Tap **Start > Internet Explorer**.
2. To go to a web site, enter the URL address of the desired web site in the address bar that appears at the top of the screen. Tap the down arrow (▼) to choose one web site from previously entered addresses.
3. Tap the **Go** icon (🔄) to go to the web address you entered.
4. Tap **Back** to go back to the previous page.
5. Tap **Menu > Refresh** to refresh the web page on the screen.
6. Tap **Menu > Home** to go back to the Home page.
7. Tap **Menu > Favorites**, and then select the favorite web site you want to visit. To add a favorite link while browsing the Internet, go to the page you want to add. Then, tap **Menu > Add to Favorites**, or tap and hold on the page to select **Add to Favorites** from the shortcut menu.



Internet Explorer Mobile

9. Using the Camera

Taking photos and recording video clips along with audio is easy with your device's built-in camera.

Launch the camera

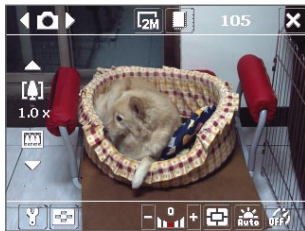

- Tap **Start > Programs > Camera**.
- Tap **Start > Programs > Pictures & Videos**, then tap the **Camera** icon.
- Press the CAMERA button on your device.

To exit the camera, tap the **Exit** icon (**X**) on the screen.





Camera screen

Capture a still image

1. After launching the camera, tap  or  at the upper left side of the screen or roll the Trackball left or right to select the **Photo** capture mode.
2. Press the CAMERA button or the Trackball to capture a still image.

Capture a video clip

1. After launching the camera, tap  or  at the upper left side of the screen or roll the Trackball left or right to select the **Video** capture mode.
2. Press the CAMERA button or the Trackball to start recording a video clip. To stop recording, press the CAMERA button or the Trackball again.

10. Using Pictures & Videos

The **Pictures & Videos** program collects, organizes, and sorts all of your captured images and video clips on your device.

You can use this program to view/play pictures, GIF animation, and video clips. You can even view pictures as a slide show, beam them, send them via e-mail, edit them, or set them as the background on the Today screen.

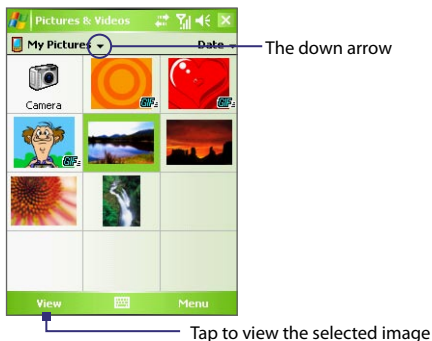

View pictures

1. Tap **Start > Programs > Pictures & Videos**. The files in the My Pictures folder appear as thumbnails by default.
2. Select a picture and tap **View**.

Play GIF animation files

1. Tap **Start > Programs > Pictures & Videos**.
2. Select a GIF animation file and tap **View**. The GIF Animation program then opens and plays the animation.

Play videos

1. Tap **Start > Programs > Pictures & Videos**. By default, the contents of the My Pictures folder will be shown.
2. To find the video clips that you captured, tap the down arrow (▼) next to the My Pictures folder and tap My Documents. Next, tap My Videos. Video clips are displayed as thumbnails by default, which appear with a media icon (🎬).



The media icon

3. Tap the desired thumbnail to play it with the built-in Windows Media Player.

11. Music Entertainment

Open **Media Hub** on your device for music entertainment and easy access to multimedia programs. Media Hub is a program launcher that gives you quick access to programs such as FM Radio, Audio Manager, and more.

Open Media Hub

Do one of the following:

- Press the MEDIA HUB button on your device.
- Tap **Start > Programs > Media Hub**.

You will find the following multimedia programs in Media Hub:



No.	Icon name	Multimedia program
1	FM Radio	Launches FM Radio where you can listen to your favorite FM stations.
2	Audio Manager	Launches Audio Manager where you can create playlists and play back music.
3	My Photo	Launches Pictures & Videos and displays the contents of the My Pictures folder.
4	My Video	Launches Pictures & Videos and displays the contents of the My Videos folder.
5	Audio Booster	Launches Audio Booster where you can adjust audio settings such as 3D sound, equalizer, etc. for a more dynamic sound experience.





To launch a multimedia program, do one of the following:

- On the Media Hub screen, tap the icon of the desired program.
- Use the Trackball or Track Wheel to scroll to the icon of a desired program then press the Trackball.

FM Radio

FM Radio allows you to listen to FM radio stations on your device. Since FM Radio uses the provided stereo wired headset as an antenna, you must plug in the headset first onto the earphone jack of your device before you open the program. The first time FM Radio is opened, it will automatically scan for available FM channels in your area, save them as presets, then play the first FM station found.

To tune in to an FM radio station

- Tap  or  to fine tune an FM radio station signal by decreasing or increasing the radio frequency by 0.1MHz.
- Tap  or  to tune in to the next lower or higher FM channel that the device can pick up.

To save your favorite FM stations to the preset buttons

For easy access to your favorite radio stations, you can save up to 6 FM stations to the preset buttons on the FM Radio screen.

1. Tune in to the desired FM station.
2. Tap the number on an empty preset button.

Tap here



Audio Manager

Audio Manager is a music browser and player in one. It gives you access to all the music files on your device, and allows you to easily browse for the music that you want to play by organizing music into categories such as title, artist, album, etc. You can also create playlists of your favorite songs and use the integrated **Music Player** to play them back.

Note Music files are categorized under **Artists**, **Album**, **Genre**, etc. if such metadata are found in the files. Music files that are protected by Digital Rights Management (DRM) will also be listed under the **Protected** category.



To browse and select songs

- Tap **All Songs** to see a complete list of music files that are stored in the device memory, built-in hard disk, and storage card.
- Tap a category. You will see more submenus which may have deeper levels of menus. For example, when you tap the **Artists** category, another level of submenus will be listed showing artist names. When you tap an artist name, more submenus showing album names will be displayed. Just keep opening the submenus until you reach the level where song titles can be selected for playback.

Music Player

Music Player is integrated within Audio Manager, and it lets you play back music files. When you select a song in the Library, Music Player opens and automatically plays it.

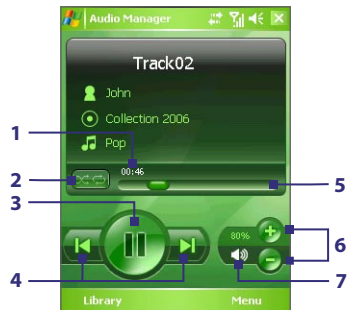

This control	Does this
1	Shows the playback time. Tap Menu > Time Display to choose the time display format.
2	Shuffle/Loop songs.
3	Play/Pause the song.
4	Go to the previous/next song.
5	Drag the slider to move forward or backward in a song.
6	Increase/Decrease the volume.
7	Mute/Unmute.

Set music as ring tone

Audio Manager allows you to select your favorite music and set it as a ring tone for your device.

1. Use the Trackball or Track Wheel to select a song in the Library, or tap a song to play it in Music Player.
2. Tap **Menu > Set as Ring Tone**.
3. If the selected song is in MP3 format, you can trim it first to make it shorter. Tap **Trim** to open the MP3 Trimmer and trim the song. See “MP3 Trimmer” for more information.

4. Tap **Set as Default Ring Tone**.

5. A confirmation message is then displayed. Tap **OK**.

MP3 Trimmer

Before setting an MP3 file as a ring tone for your device, you can edit the song first to shorten the duration and make the file size smaller. Use **MP3 Trimmer** to cut the song shorter.

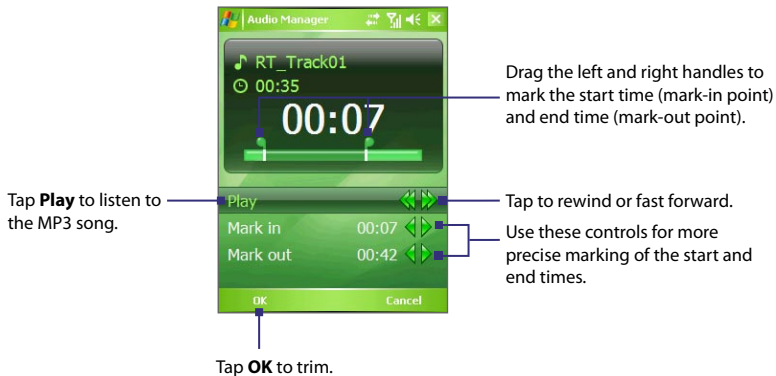



12. Entering Information

When you start a program or select a field that requires text or numbers, the **Input Panel** icon becomes available on the menu bar.

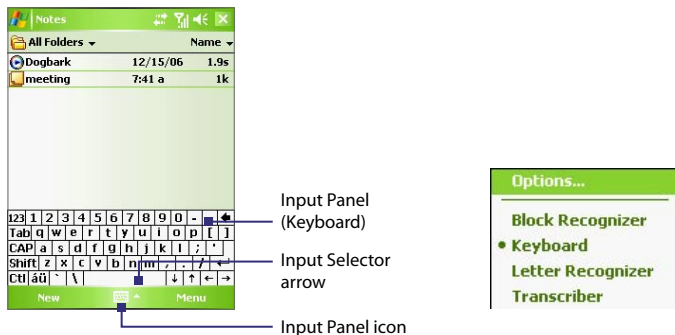
Tap the **Input Selector** arrow (that appears next to the **Input Panel** icon) to open a menu where you can select a text input method and customize input options. After selecting a text input method, the corresponding **Input Panel** is then displayed and you can use it to enter text. To toggle between showing and hiding the Input Panel, simply tap the **Input Panel** icon.

































Icon	Input method
	On-screen Keyboard
	Letter Recognizer or Block Recognizer
	Transcriber















Note Some text input methods may not be available in certain language versions of the device.

13. Status Indicators

The Today screen displays important information, such as upcoming appointments and status indicators. Following are some of the status icons that you may see on your device:

Icon	Description
	New e-mail or text messages; SMS notification of voice mail
	New multimedia (MMS) message
	New MSN message
	There are more notifications. Tap the icon to view all.
	Speakerphone on
	Dialing while no SIM card is inserted
	Voice call in progress
	Calls are forwarded
	Call on hold
	Missed call
	Maximum signal strength
	No signal
	Phone is turned off
	No phone service

Icon	Description
	Searching for phone service
	GPRS available
	GPRS connecting
	GPRS in use
	EDGE available
	EDGE connecting
	EDGE in use
	Roaming
	Connection is active
	Connection is not active
	Synchronization in progress
	Synchronization error
	ActiveSync notification
	Wi-Fi function enabled, but device not connected to a wireless network yet
	Wireless network(s) detected
	Connecting to wireless network (arrows moving); Connected to wireless network

Icon	Description
	Synchronizing via Wi-Fi
	Vibration mode
	Sound on
	Sound off
	Alarm
	No SIM card inserted
	Battery is fully charged
	Battery power is very low
	Battery charging
	Device is locked
	Device is unlocked
	Bluetooth headset detected
	GPRS Monitor currently active
	Sprite Backup notification
	Serial USB connection active

Note The USB to PC () icon appears on the Today Screen when your device is connected to your computer and you enable a serial USB connection between them. For more information about USB to PC, refer to the user manual.

14. Customizing Your Pocket PC Phone

You can customize the look and feel of your device and set the time and date according to the current time zone.

Customize the Today screen

1. Tap **Start > Settings > Personal tab > Today**.
2. On the **Appearance** tab, select the desired theme for the background of the Today screen.
3. On the **Items** tab, select the items you want to appear on the Today screen.

Customize the Start Menu

1. Tap **Start > Settings > Personal tab > Menu**.
2. Select the check boxes of the items you want to appear in the Start menu. You can select up to seven items.

Set the time and date

1. Tap **Start > Settings > System tab > Clock & Alarms**.
2. Select the correct time zone and change the date or time.

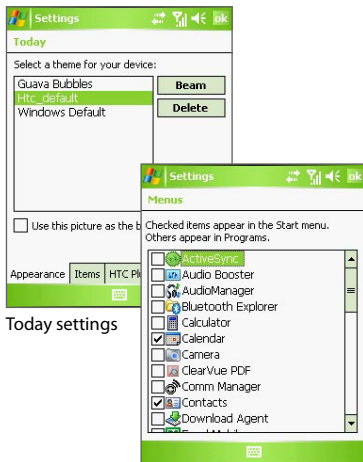

Today settings

Menu settings

15. Securing Your Pocket PC Phone

There are two kinds of security on your device. You can protect your SIM card from unauthorized use by assigning a **PIN** (Personal Identification Number). Additionally, you can prevent unauthorized access to any part of the device by using password protection.

Protect your SIM card with a PIN

1. Tap **Start > Phone**.
2. On the Phone screen, tap **Menu > Options > Phone** tab.
3. Tap **Require PIN when phone is used**. To change the PIN at any time, tap **Change PIN**.

Protect your device with a password

1. Tap **Start > Settings > Personal tab > Lock**.
2. Select the **Prompt if device unused for** check box, and in the box to the right, select how long your device must be idle before a password is required. In the **Password type** box, select the type of password you would like to use. Enter the password and confirm it.
3. On the **Hint** tab, enter a phrase that will help you remember your password, but doesn't allow others to guess your password. The hint will be displayed after the wrong password is entered four times.
4. Tap **OK**. The next time your device is turned on, you will be prompted to enter your password.

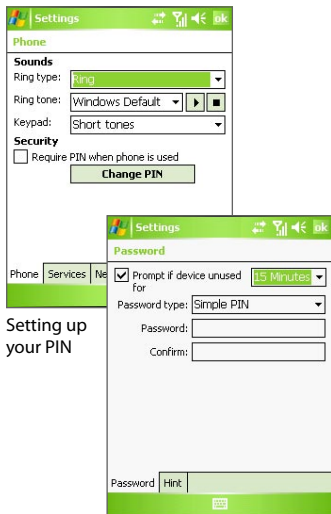

Setting up your PIN

Setting up password

16. More Information

For more instructions, refer to the User Manual or contact your local dealer for assistance.