

PYLE®

PLD43MU

OWNER'S MANUAL Mobile Video System

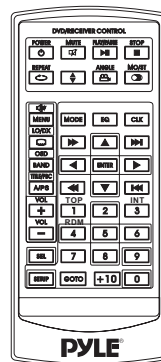
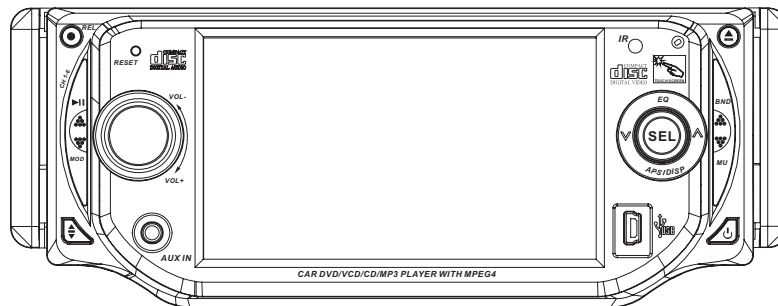

- Motorized Slide Down And Detachable Panel
- 4.3 Inch Wide Color Touch Screen Monitor
- CAR DVD/VCD/CD/MP3 Player
- AM/FM Digital PLL Tuning Radio
- MPEG4 Player
- USB Connect

Contents

Preautions	2	Setup	26
Safety Information	3	General Setup	26
Disc Notes	4	Speaker Setup	28
Installation	5	Dolby Digital Setup	28
Detaching the control panel	7	Preferences Setup	29
Changing the control panel	8	Defaults Table	30
Electric Connection	9	Other Main Operations	31
Remote Control	10	USB Operations	31
Control Panel	12	AUX Operations	31
Touch Panel.....	12	MP3/WMA/JPEG Play	32
Unit Keys	13	MPEG4 Play	32
Basic Operations	16	Specifications	33
TFT Monitor Adjustment	17	Trouble Shooting	34
Rear View Camera	17		
Audio Quality Adjustments	17		
Setting Audio Mode	18		
Scroll Caption Adjustments	18		
Alternate Audio/video Source	18		
Radio Operations	19		
Listening to the radio	19		
Storing stations in memory	19		
Listening to a preset station	20		
DISC Operations	21		
Basic Operations	21		
Select Playback Mode	22		
On-Screen Disc Operations	24		
DISC Special Functions	25		
Selecting audio languages	25		
Selecting Subtitles	25		
Selecting multi-angle views	25		
Title menu function	25		

Precautions

THANK YOU FOR PURCHASING THIS CAR DVD PLAYER .

Before operating the unit, read this manual thoroughly and keep it handy for future reference .

To avoid injury or accident , read the following precautions before installing and operating the unit .

ON INSTALLATION

- DO NOT install any receiver in locations where;
 - it may obstruct the steering wheel and gearshift lever operations, as this may result in a traffic accident.
 - it may obstruct the operation of safety devices such as air bags, as this may result in a fatal accident.
 - it may obstruct visibility.
- DO NOT operate any receiver while manipulating the steering wheel, as this may result in a traffic accident.
- The driver must not watch the monitor while driving.
- IF THE DRIVER watches the monitor while driving, it may lead to carelessness and cause an accident.
- IF YOU NEED to operate the receive while driving, be sure to look ahead carefully or you may be involved in a traffic accident.
- IF THE PARKING BRAKE is not engaged. " ParkingBrake" flashes on the monitor, and no playback picture will be shown.
 - This warning appears only when the parking brake wire is connected to the parking brake system built in the car (refer to the electric connection)

ABOUT THE LIQUID CRYSTAL DISPLAY (LCD) PANEL

Do not press on the LCD panel on the unit as doing so can distort the picture or cause a malfunction . The picture may become unclear , or the LCD panel may be damaged .

NOTES ON CLEANING

- Clean the LCD panel with a slightly damp soft cloth.
 - Do not use solvents such as benzine, thinner, commercially available cleaners or antistatic spray .
 - Do not use alcohol to clean the screen .
- If your car was parked in a cold or hot place, the picture may not be clear . The monitor is not damaged . The picture will become clear the temperature in your car becomes normal .

Safety Information

CAUTION:

THIS DVD PLAYER IS A CLASS I LASER PRODUCT. HOWEVER THIS DVD PLAYER USES A VISIBLE/INVISIBLE LASER BEAM WHICH COULD CAUSE . HAZARDOUS RADIATION EXPOSURE IF DIRECTED. BE SURE TO OPERATE THE DVD PLAYER CORRECTLY AS INSTRUCTED.

USE OF CONTROLS OR ADJUSTMENTS OR PERFORMANCE OF PROCEDURES OTHER THAN THOSE SPECIFIED HEREIN MAY RESULT IN HAZARDOUS RADIATION EXPOSURE. DO NOT OPEN COVERS AND DO NOT REPAIR YOURSELF. REFER SERVICING TO QUALIFIED PERSONNEL.

WARNING:

TO REDUCE THE RISK OF FIRE OR ELECTRIC SHOCK, DO NOT EXPOSE THIS EQUIPMENT TO RAIN OR MOISTURE.

TO REDUCE THE RISK OF FIRE OR ELECTRIC SHOCK, AND ANNOYING INTERFERENCE, USE ONLY THE RECOMMENDED ACCESSORIES.

THIS DEVICE IS INTENDED FOR CONTINUOUS OPERATION.

This product incorporates copyright protection technology that is protected by method claims of certain U.S. Patents and other intellectual property rights owned by Macrovision Corporation and other rights owners. Use of this copyright protection technology must be authorized by Macro vision Corporation, and is intended for home and other limited viewing uses only unless otherwise authorized by Macrovision Corporation. Reverse engineering or disassembly is prohibited.

REGION MANAGEMENT INFORMATION:

This DVD Player is designed and manufactured to respond to the Region Management Information that is recorded on a DVD disc. If the Region number described on the DVD disc does not correspond to the Region number of this DVD Player, this DVD Player cannot play this disc.

Disc Notes

Disc formats supported by this player

DVD		Audio and Video Disc size 12 cm
VCD		Audio and Video Disc size 12 cm
CD		Audio Disc size 12 cm
MP3		Audio Disc size 12 cm

Discs which cannot be played with this player

- DVD-ROM
- DVD-R/DVD-RAM
- CDV
- CD-G

Handling and Cleaning

- Dirt, dust, scratches and warping disc will cause misoperation.
- Do not place stickers or make scratches on discs.
- Do not warp discs.
- A disc should always be kept in its case when not in use to prevent from damaging.
- Do not place discs in the following places:
 1. Direct sunlight
 2. Dirty, dusty and damp areas
 3. Near car heaters
 4. On the seats or dashboard

Disc Cleaning

Use a dry soft cloth to wipe the surface. If the disc is quite dirty, use a soft cloth slightly moistured with isopropyl (rubbing) alcohol. Never use solvents such as benzine, thinner or conventional record cleaners as they may mar the surface of the disc.

Note:

A disc may become somewhat scratched (although not enough to make it

unusable) depending on your handle it and conditions in the usage environment. Note these scratches are not an indication of any problem with the player.

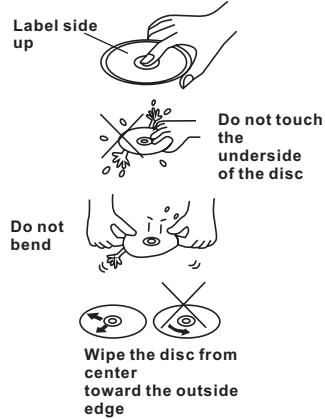

Preparing New Discs with Rough Spots

A new disc may have rough edges on its inside and outside edges. If a disc with rough edges is used, the proper setting will not be performed and the player will not play the disc. Therefore, remove the rough edges in advance by using a ball point pen or pencil as shown on the right. To remove the rough edges, press the side of the pen or pencil against the inside and outside edges of the disc.

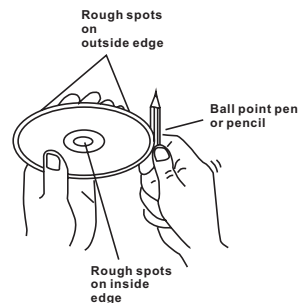

Installation

NOTES:

Choose the mounting location where the unit will not interfere with the normal driving function of the driver.

Before finally installing the unit, connect the wiring temporarily and make sure it is all connected up properly and the unit and the system work properly.

Use only the parts included with the unit to ensure proper installation. The use of unauthorized parts can cause malfunctions.

Consult with your nearest dealer if installation requires the drilling of holes or other modifications of the vehicle.

Install the unit where it does not get in the driver's way and cannot injure the passenger if there is a sudden stop, like an emergency stop.

If installation angle exceeds 30 from horizontal, the unit might not give its optimum performance.

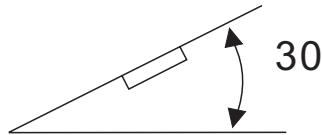

Avoid installing the unit where it would be subject to high temperature, such as from direct sunlight, or from hot air, from the heater, or where it would be subject to dust, dirt or excessive vibration.

DIN FRONT/REAR-MOUNT

This unit can be properly installed either from "Front"(conventional DIN Front-mount) or "Rear"(DIN Rear-mount installation, utilizing threaded screw holes at the sides of the unit chassis). For details, refer to the following illustrated installation methods.

Installation

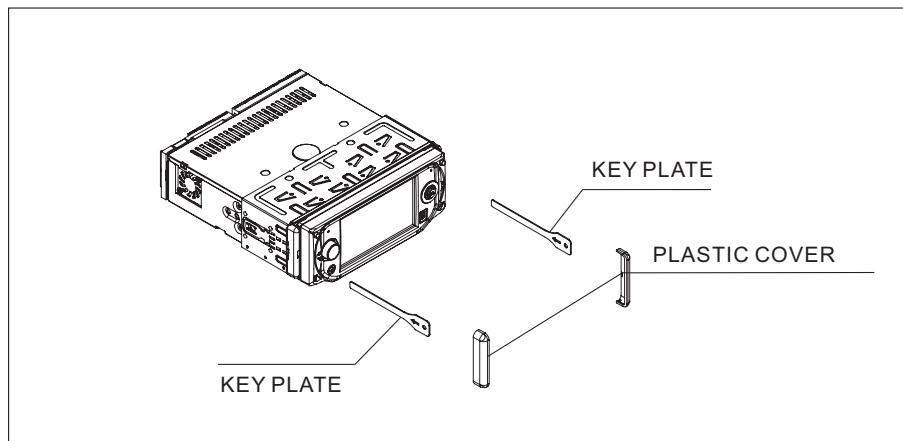
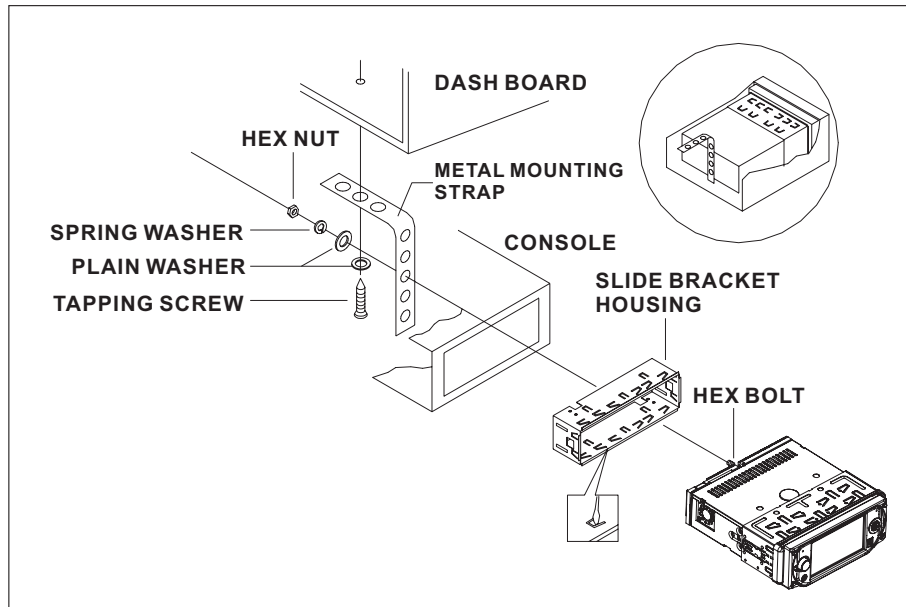

If you want to take CHASSIS out of the SLIDE BRACKET HOUSING, first remove the PLASTIC COVER of the both sides away, then insert the two KEY PLATE into left and right side of chassis as above illustration.

Installation

How To Remove And Install The Front Panel

When detaching or attaching the control panel, be careful not to damage the connectors on the back of the control panel and on the panel holder.

Detaching The Front Panel

Before detaching the control panel, be sure to turn off the power.

- 1). Press the release button and the left hand side of the front panel will release. (FIG. 1)
- 2). Pull-off the front panel (FIG. 2) and keep the front panel into the case (FIG. 3)

Attaching The Front Panel

- 1). First insert the right hand side of the front panel into the hollow of the unit .
- 2). Gently push the left hand side of the front panel until you feel a "Click". and then press the PWR button (2) briefly to switch the device ON.

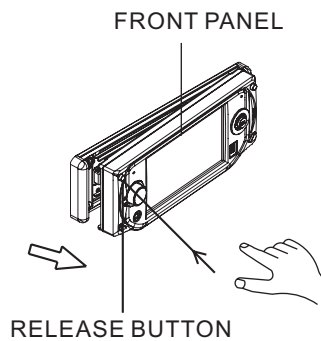

FIG.1

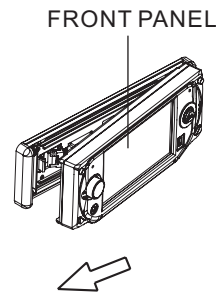

FIG.2

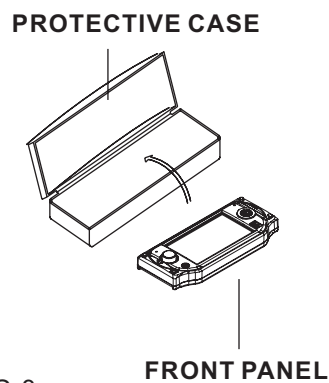

FIG.3

Attaching The Front Panel

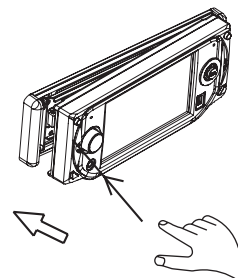

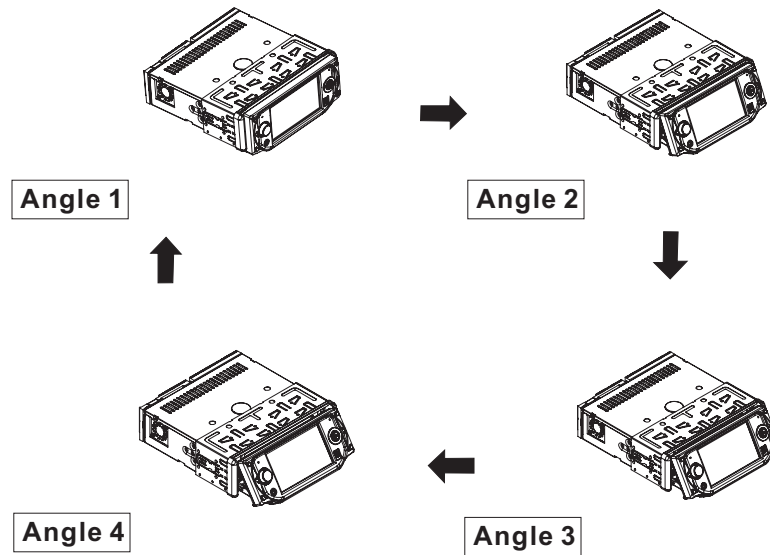

FIG.4

Panel Angle Adjustment

CHANGING THE CONTROL PANEL ANGLE

When you want to change the viewing angle of the operating unit to play, you can touch the  section on touch screen (or press the  button on the front panel) repeatedly to select the desired angle as follows:



Caution:

Do not insert your finger behind the control panel.

Electric Connection

WIRING CONNECTION

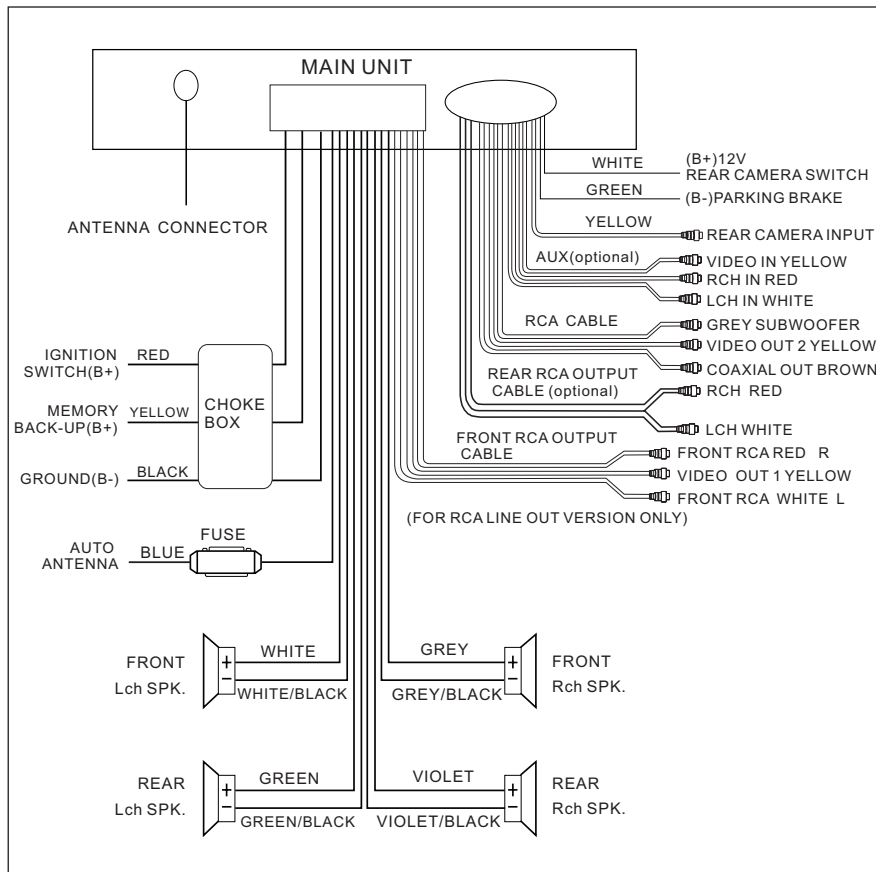

Note:
the earth connection cable (parking brake B-) must be connected in order for DVD pictures to be played back to the monitor. If the cable has not been correctly connected, the message "PARKING BRAKE" appears on the monitor.

Remote Control

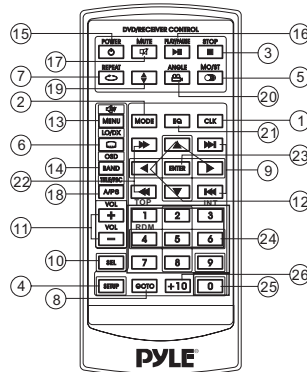

- | | |
|--|--|
| <p>1. CLK</p> <p>2. MODE</p> <p>3. STOP</p> <p>4. SETUP</p> <p>5. MO/ST(AUDIO)</p> <p>6. SUBTITLE
LO/DX</p> <p>7. REPEAT</p> <p>8. GOTO</p> <p>9. ◀ / ▶</p> <p>10. SEL</p> <p>11. VOL+/VOL-</p> <p>12. ▲ / ▼ / ▶ / ◀</p> <p>13. MENU</p> <p>14. SUB WOOFER</p> <p>15. POWER</p> <p>16. PLAY/PAUSE</p> <p>17. MUTE</p> <p>18. TITLE/PBC
(A/P)</p> <p>19. ◀</p> <p>20. ANGLE</p> <p>21. EQ</p> <p>22. ◀ / ▶</p> <p>23. ENTER</p> <p>24. Radio Preset</p> <p>25. 0-9</p> <p>26. +10</p> | <p>Press it briefly to show/hide the clock, press longer to set the time.</p> <p>Press it to change between RADIO ,DISC and AUX IN mode.</p> <p>Press it to stop playback. Press PLAY/PUASE to resume playback .</p> <p>Press it to open the SETUP menu.</p> <p>In radio mode, press it to select STEREO or MONO mode (In disc mode,press it to changing of the AUDIO soundtrack on multi-audio soundtrack DVD disc. Changing of the sound mode of the VCD/CD disc)</p> <p>Changing of the SUBTITLE language on multi-subtitle language DVD disc. In radio mode, .Press this button for distance reception when you are located at weak signal location, depress it for stronger signal.</p> <p>Switch the Repeat mode of DVD/VCD/CD/MP3 disc.</p> <p>Disc search button, cooperatively used with numeric buttons</p> <p>Press ▶ to skip to the next track & press ◀ to skip back one track. (Note: In DVD mode, press continually the ◀ twice to skip back one)</p> <p>Press it repeatedly to change mode through volume ,bass, treble, balance, fader ,color, bright, contrast and tint modes.</p> <p>Press it to adjust volume level</p> <p>In case of the SETUP MENU mode, ▲ / ▼ / ▶ / ◀ buttons served as cursor buttons to select item left/right, ahead/back.</p> <p>Press it briefly to display the main menu of the DVD/VCD. Press it long to switch the SUBWOOFER ON and OFF.</p> <p>Display statistical disc information during playback (To change the band in radio stations)</p> <p>Press it to turn on the unit ,press it again to turn off.</p> <p>In DISC mode, starting playback, stopping picture/track.</p> <p>Press it to mute down sound.</p> <p>Display the TITLE menu that is stored in DVD disc changing between PBC ON and PBC OFF on the VCD disc. (Auto store and preset scan function in radio stations .)</p> <p>Press it to change the view angle of the front panel .</p> <p>Changing of the view angle on multi-angle DVD disc.</p> <p>Press it to turn to equalization function.</p> <p>Press ▶ to start forward rapidly & ◀ to reverse rapidly.</p> <p>Confirm the Track/Chapter selected with the number key or selected with the cursor buttons on TV screen.</p> <p>Six preset memory buttons.</p> <p>Numeric buttons.</p> <p>Tens digit select button, cooperatively used with numeric buttons.</p> |
|--|--|

Remote Control

Preparing the Remote Control

Installing The Lithium Coin Battery

1. First push to inside as the direction indicated by the arrow (See ①) And then Remove the battery holder as the direction indicated by the arrow (See ②).
2. Replace the battery Set a new battery property with (+)side up as illustrated (See ③).
3. Insert the battery holder. Push in the holder to the original position(See ④).

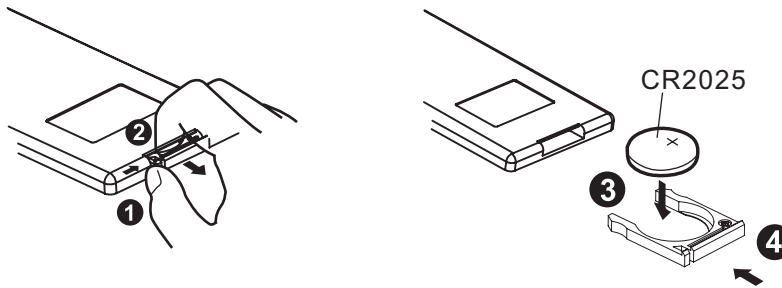

Using the Remote Control

Face the remote control towards the player front face IR mark (remote control signal receiver), make sure there is no obstacle in between .

Operation angle: About ± 30 degree in each the direction of the front of the IR mark.

Warning :

Do not install any battery other than CR2025 or its equivalent;
otherwise , it may explode .

Store the battery in a place where children cannot reach to avoid risk
of accident .

Control Panel

Key Functions

Touch Panel

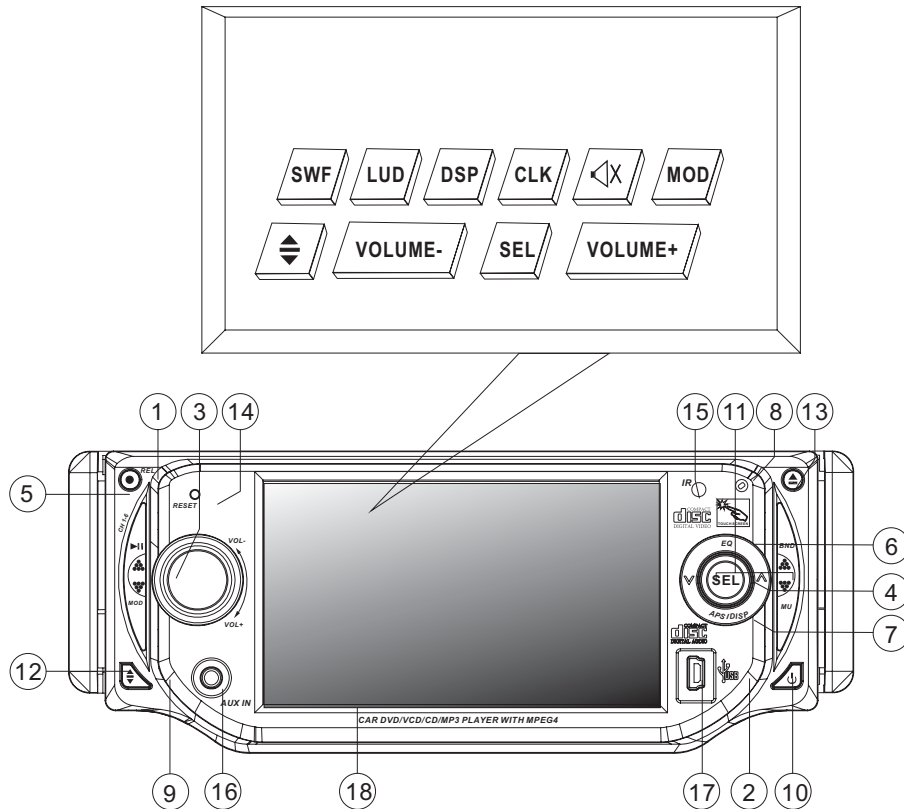

Touch Screen Key :

- 1. **SWF** : subwoofer function
- 2. **LUD** : loud function
- 3. **DSP** : EQ function (pop/classic/jazz/rock/flat)
- 4. **CLK** : clock function
- 5. **⊘X** : mute function
- 6. **MOD**: select input mode
- 7. **VOLUME+** : volume adjustment (+)
- 8. **SEL** : select the menu of the Sound/Picture
- 9. **VOLUME-** : volume adjustment (-)
- 10. **⇄** : panel angle adjustment

Control Panel

Unit Keys :

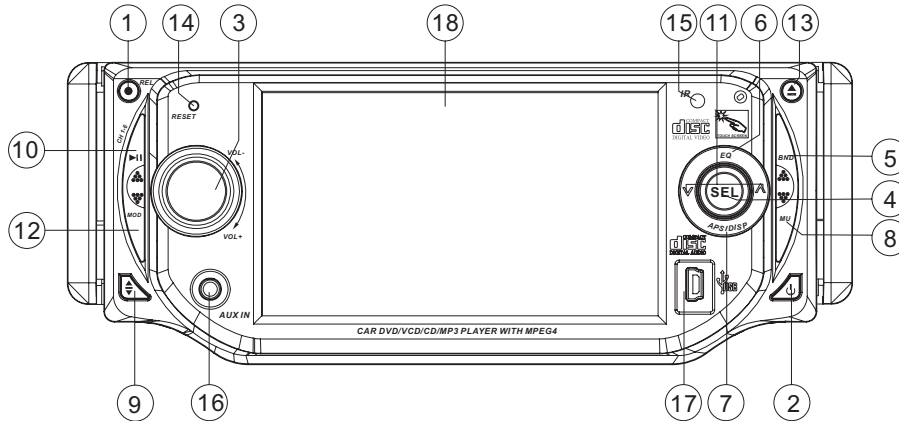

1. REL BUTTON

Press this button to release the front panel for removal . Refer to see page 6.

2. ⏻ (POWER On/Off) BUTTON

Press this button to switch the device on. WELCOME appears in the display. Press it again to switch the device off. SEE YOU appears in the display.

3. VOL+ / VOL- knob

In normal mode, this knob is used to increase or decrease the volume. It is also used as an UP/DOWN knob when audio or video settings are being adjusted when accessed using the SELECT button.

4. SELECT KNOB

To access the available adjustment settings for audio and video, press this knob repeatedly to cycle through and select them:

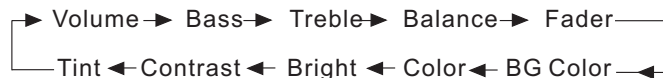

5. BAND BUTTON

In Radio mode, press this button repeatedly (or the BAND button on the remote control) to cycle through and select the desired radio band:

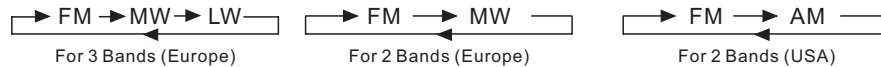

6. EQ BUTTON

Swing the SEL knob briefly in the EQ direction to turn to equalization function and to select desired audio mode. There are five kinds of mode as below:

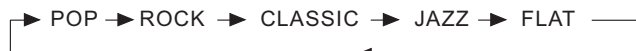

Control Panel

7. APS, DISPLAY FUNCTIONS (using the SELECT knob)

Scan Function

In Radio mode, swing the SEL knob briefly in the APS/DISP direction , the radio briefly plays all the preset stations of the frequency band .

Automatic Preset Setup

In Radio mode, swing the SEL knob in direction of the APS/DISP for approximately 2 seconds to active automatic station storage. The radio searches within the current frequency band, e.g. Fm1, for the stronger signal level until the search cycle has finished . The six strongest stations are then allocated to the corresponding storage locations . Then the station of the first storage location is set .

Display ON/OFF Function:

In Disc mode, swing the SEL knob briefly in the direction of APS/DISP to turn off the display image (the monitor on the unit only) , the sound will stay on. (Swing it again to resume the playback picture mode.) You can press SEL knob briefly to select the "BG COLOR" by repeatedly pressing the SEL knob, then rotate the VOL+/- to select the background color among of the "AUTO, BG COLOR: 01.....BG COLOR: 11", in "AUTO" mode, the monitor of unit will change the background color automatically.

8. MU (MUTE) BUTTON

Press this button briefly to turn off the audio. Press again to restore the volume to prior level. You can also disable the MUTE function by turning the VOL +/- knob.

9. ANGLE (Screen position)

This button allows you to change the angle of the screen module in four steps. Press this button repeatedly to cycle through the different positions.

10. ► / CH 1-6 (RADIO PRESET)BUTTON

a). In Disc Playback Mode

Press this button to pause playback, press it again to resume playback.

b). In Radio Mode

Press this button repeatedly to preset station. With this system a total of 30 stations can be stored in the memory .

The operation as below:

- store in memory

press and hold the desired memory location for several seconds, the current listening station will be stored into the number location.

- retrieve a preset station

press it button repeatedly to retrieve a station which had been stored in the memory in advance the chosen number is shown on display.

11. ▼ / ▲ BUTTONS (TUNE, SEEK, TRACK, SKIP UP/DOWN)

a) In DISC, USB mode:

if you wish to jump forwards or backwards press the SEL button (4) briefly in the ▲ or ▼ direction. (Note: in DVD mode, press the SEL button continually twice in ▼ direction to skip back one track during playback.)

To wind through the tracks keep the SEL button pressed in the ▲ or ▼ direction for about 2 seconds. FF X2 appears in the display. Operating the SEL button again,

Control Panel

the speed of rapid forward/reverse changes according to the disc as follow:

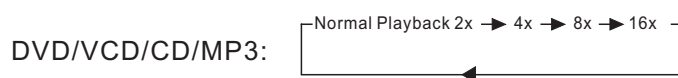

b) In Radio Mode:

Move the SEL button in the direction of ▲ or ▼ in order to set a radio station manually. Keep the SEL taste pressed down in the ▲ or ▼ direction in order to start the search for a radio station automatically.

12. MODE BUTTON

Use this button to select an input mode by pressing repeatedly until the proper one is found: AUX IN > RADIO > DISC

If you are in USB Playback mode and want to select DISC mode, press the STOP button and then the GO TO button.

13. ▲ (EJECT) button

To insert a disc, press this button. The panel will swing downward, exposing the slot. Insert the disc, label side facing up, until the mechanism senses its presence and draws the disc in. The panel will automatically return to its previous position.

14. RESET button

Press this button can return to the original setup .

15. IR sensor

16. AUX INPUT JACK

For information about connecting a AUX device, please see page 31 .

17. USB PORT

For information about connecting a USB device, please see page 31.

18. TFT Display (liquid crystal display)

The operation of the TFT, please see page 17.

Basic Operation

Power ON/OFF



Press it button on front panel or on the remote to switch the device ON or OFF .

VOLUME-



Touch the screen the VOLUME- section to decrease volume level .

Ejecting The Disc



Use your finger touch the “▲” range on touch screen , the control panel of the unit will swing downwards .Then you can insert the disc or eject the disc .

(You can also press the “▲” button on the front panel to eject the disc or insert the disc to start play .)

Mute Function



Use your finger touch the “⏏” section , it will mute the sound but the disc continues playing. Touch it again to resume .

Select Sources

MOD



Touch repeatedly the “MOD” section on screen the signals will display in the screen as follow :

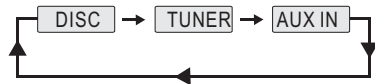

Setting The Clock



Touch the CLK section on the screen and hold for about 2 seconds the hour will flash , rotate the VOL+/- to adjust .

Touch it again, the minute will flash, then use the VOL+/- to adjust .

Volume Adjusting

Volume button



Revolve : clockwise to increase /
Anticlockwise to decrease .



Press the VOL+/- on remote control ,
to change the volume level .

Setting The Buzzer ON/OFF



Touch the SEL section on the touch screen to select the BUZZER item, and then touch the VOL+/- (or rotate the vol+ /vol-) to switch the BUZZER ON/OFF .

Touch screen

VOLUME+



Touch the screen the VOLUME+ section to increase volume level .

Adjusting the panel angle



Touch the “◀▶” section on the touch screen repeatedly to change the viewing angle of the operating unit .

(You can also press the ◀▶ button on the front panel to change the angle . Refer to see page 8 .)

Basic Operation

TFT Monitor Adjustment



During DISC playback, use your finger touch briefly the SEL section on the screen (or press SEL knob on the front panel)

to across the Picture mode selection menu, by repeatedly touch the SEL section, and then touch the VOL +/- (or rotate the VOL +/-) to adjust the selected mode .
(The corresponding value will show on the monitor)

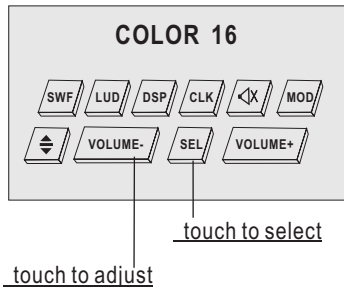
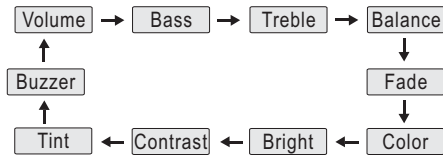

ADJUSTABLE ITEMS:

COLOR: 0 to 32

Adjust the color fo the picture-lighter or darker.

BRIGHT: 0 to 32

Adjust if the picture is too bright or too dark.

CONTRAST: 0 to 32

Adjust the contrast of the bright and dark portion.

TINT: 0 to 32

Adjust the tint if the human skin color is unnatural.

-Adjustable when "NTSC " is selected for "NTSC/PAL " .

Rear View Camera

When connecting the rear view camera. the mirror image of the rear view through the rear view camera is automatically displayed on the monitor when you change the gear to the back position. (The monitor on the unit only.)

Audio Quality Adjustment



During DISC playback, use your finger touch briefly the SEL section on the screen (or press SEL knob on the front panel)

to across the Sound mode selection menu, by repeatedly touch the SEL section, and then touch the vol +/- (or rotate the vol +/-) to adjust the selected mode . (The corresponding value will show on the monitor)

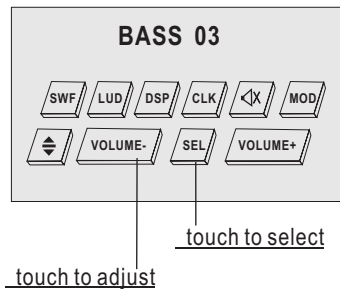
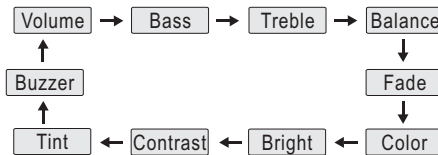

(It's depend on your habit to setup the data .)

ADJUSTABLE ITEMS:

Volume: 0 to 32

Adjust volume level by using VOL + / - .

Bass: -14 to +14

Adjust bass level by using VOL + / - .

Treble: -14 to +14

Adjust treble level by using VOL + / - .

Basic Operation

Balance: R10 to L10

Adjust sound balance between left and right speakers by using VOL + / - .

Fader: F10 to R10

Adjust sound balance between front and rear speakers by using VOL + / VOL - .

front panel to ahead/back (proceed/cancel) , and then press the SETUP button briefly to confirm .
(Press it button longer again to renew .)

Setting Audio Modes



Touch the screen the DSP range (or press the EQ button on the front panel) to select one of the preset sound modes

(Rock/Pop/Jazz/Classic/Flat) .
The information will display in the monitor as follow :

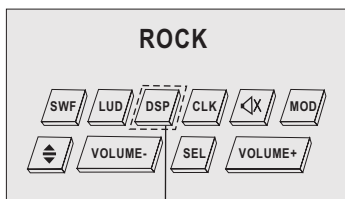
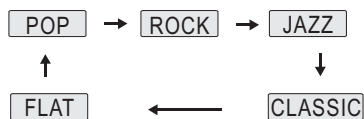

touch to select

It's depend on your habit to select the Audio mode .

Scroll Caption Adjustment

In Radio mode:

You can adjust your desired scroll caption , the method of the operation as follow:

- Press and hold the SETUP button (for about 2 seconds) on the remote control, the adjustment scroll bar will display on the screen .
- Use the VOL+/- to select among of the "A, B, CX, Y, Z, and blank ", and use the ∇ / ▲ button on the

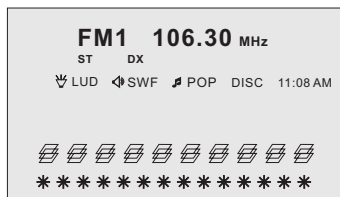

Alternate Audio/video Source

Following the diagram below, to connect analogue replay devices. Use this jack to replay sound of other replay equipment such as DVD players, computers, etc. Via the loudspeakers.

- Please connect the external device with stereo jack(black end) plug the Aux in socket of the unit .
- Press the MOD button to select the AUX IN connection.
- With the buttons on the external device to operate the item of the playing.

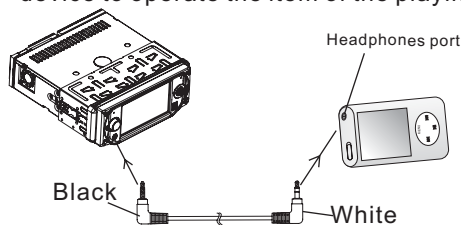

(connect cable)

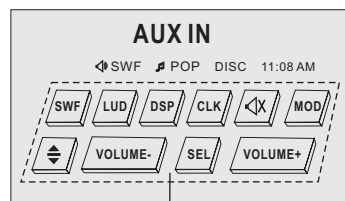

touch to select

Radio Operation

Listening to the Radio

Switching To Radio Mode



Repeatedly Touch the MOD section on the touch screen to select the RADIO mode. (You can press the MOD button on front panel to select the Radio mode .)

the following information will appears on the monitor :

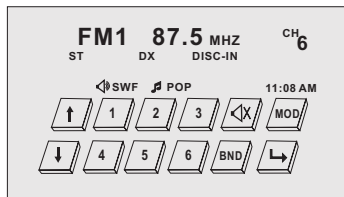

Selecting The Frequency Band

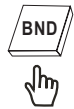

Touch the BND section on the touch screen repeatedly to select the band , screen band will show in turn :

(You can also press the BND on front panel repeatedly to select the band .)

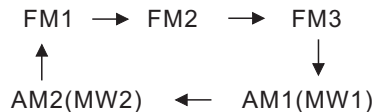

Start Searching For a Station

Manual Search

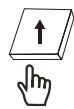

Touch briefly the “ ↑ ” section on the screen (or swing briefly the SEL knob in ^ direction) to increase frequency by one step of channel spacing .

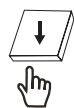

Touch briefly the “ ↓ ” section on the screen (or swing briefly the SEL knob in v direction) to decrease frequency by one step of channel spacing .

Automatic Search

During Radio mode, swing and hold (for about 2 seconds)the SELknob in v / ^ direction (or touch the ↑ / ↓ section long) to start search for a radio station automatically .

Storing Stations In Memory

Setting Memory

Press the ►/CH 1-6 button repeatedly on the front panel to preset stations at radio mode . (Or touch the screen the 1 / 2 / 3 / 4 / 5 / 6 sections)

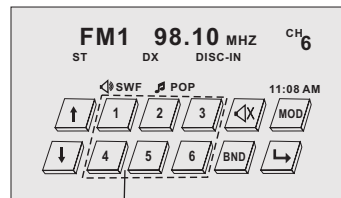

Touch to preset station

With this system, a total of 30 stations can be stored in the memory of six preset buttons. Each band stores up to six preset stations. The stations might be FM1, FM2, FM3, AM1(MW1), and AM2(MW2) band.

The operation is as below :

-Store in Memory

Touch and keep the 1-6 sections (or press and hold the ►/CH 1-6) for about 2 seconds, the current listening station will be stored in the number location .

-Retrieve a preset station

Touch the 1-6 sections briefly (or press the ►/CH1-6 button repeatedly) to retrieve a station which had been stored in the memory in advance the chose number is shown on display .

Radio Operation

Automatic Memory Storing & Program Scanning

Automatic Preset Setup

 In Radio Mode, Touch the APS section and keep on the touch screen (or swing the SEL knob in direction of the APS/DISP) for about 2 seconds to active automatic station storage. The radio searches within the current frequency band, e.g. FM1, for the stronger signal level until the search cycle has finished. The six strongest stations are then allocated to the corresponding storage locations. Then the station of the first storage location is set.

Scan Function

 In Radio mode, touch the APS section or swing the SEL knob briefly in the APS/DISP direction, the radio briefly plays all the preset stations of the frequency band.

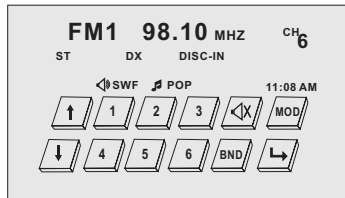

 Touch it to select the other item.

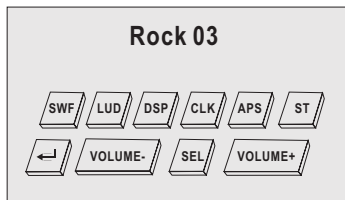

Mono/Stereo Function

 In Radio mode, touch the ST section on screen (or press MO/ST button on remote) to select mono or stereo mode. you can sometimes improve reception of distant stations by selecting mono operation.

Loud Function

 Touch the LUD section on the touch screen to switch the LOUD ON or OFF.

EQ Function

 Touch the DSP section repeatedly on the touch screen to select the EQ (pop/rock/jazz/classic/flat)

Select Audio Mode

 Touch the SEL section repeatedly on the touch screen to select the desired item (volume/bass/treble/balance/fader)

Select BG Color Function

 Touch the SEL section briefly on the touch screen to select the "BG Color" by touching repeatedly the SEL knob, then touch the VOL +/- (or rotate the VOL +/- on the front panel) to select your desired Background Color.

Mute Function

 Use your finger touch the "MUTE" section, it will mute the sound but the disc continues playing. Touch it again to resume.

Buzzer Function

 Touch the SEL section on touch screen repeatedly to switch the Buzzer ON or OFF by using the VOL +/-.

DISC Operation

Basic Operation

During the DISC playback, use the finger touch the touch screen , it display will following :

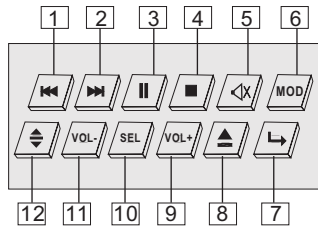

- | | |
|------------|-----------------------|
| 1.previous | 7.To next page |
| 2.next | 8.eject |
| 3.pause | 9.vol+(adjustment +) |
| 4.stop | 10.select |
| 5.mute | 11.vol-(adjustment -) |
| 6.mode | 12.panel angle change |

Switching the DVD mode

Touch the MOD section on the touch screen (or press MOD button) to select the DISC mode, it display like following :

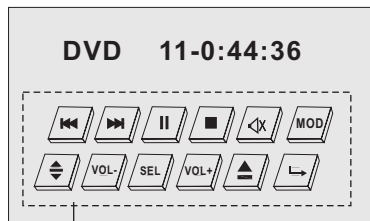

Function setup
(different the source the display is different)

Stopping Play

Touch the screen the ■ range (or press the ■ button on remote control .) To stop the unit playback. Touch the ▶▶ section or press ▶▶ button on front panel to start play.

Skipping Track

During DISC playback, Touch the ▶▶ section on the touch screen to skip to next track. (You can also swing the SEL knob in ▲ direction to skip to next track.)

During DISC playback, Touch the ◀◀ section on the touch screen to skip to back one track .(You can also swing the SEL knob in ▼ direction to back one track .)

NOTE :

1. In DVD mode, touch the ◀◀ section continually twice to back one track .
2. For some VCD2.0 disc (PBC-playback control), above these buttons may be unavailable .

Rapid Forward/Rapid Reverse

During DISC playback, Touch and hold (for about 2 seconds)the ▶▶ / ◀◀ section on the touch screen (or swing the SEL knob in ▼ / ▲ direction on front panel and hold for a more than 2 seconds) the speed of rapid forward/reverse changes according to the disc as follow:



Pause (still picture)



Touch the “ II ” section on touch screen during playback will stop play temporary, touch it again to return the normal playback .

Zoom Function

Repeatedly touch the section of the ZOOM, the displaying rate can be 1x, 2x, 3x, 1/2, 1/3, 1/4 .



DISC Operation

Mute Function

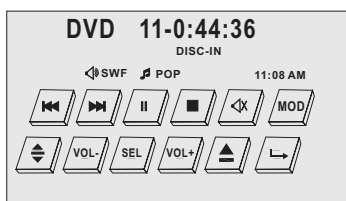

 Touch the “” section on touch screen (or press the MU button on front pane) during playback will mute sound but the disc continues playing . Touch it again , sound will resume .

Selecting The Play Modes





 Touch the  section , it display will following as below :



 Touch the  section , it display will following as below :



 Touch the  section , it display will following as below :

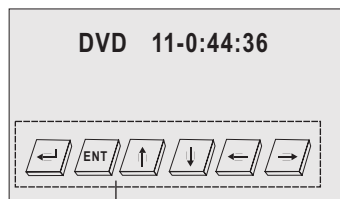

Above these operation cursor buttons for DVD setup.

 Touch it for previous .

1). Repeat Function

FOR DVD :

 Touch the screen “ RPT ” section (or press longer RPT on remote control) to select REPEAT mode as follow :



FOR VCD/CD/MP3 :

 Touch the screen “ RPT ” section (or press longer RPT on remote control) to select REPEAT mode as follow :



1. Continuously repeat at the current chapter/track, when selected REP-ONE mode .
2. Select REP-ALL mode to continuously repeat all chapter/track on the current disc .

DISC Operation

2). RDM(RANDOM) Function

 During DISC playback, Touch the RDM section (press the 4/RDM button longer on remote control to play in random. Each playing, the order is different . (depend on the disc used for VCD).

3). INT Function

FOR CD :

 Touch the screen the INT section (or long press the 3/INT button on the remote to play the previous 6 seconds part of each track/chapter on disc.

FOR VCD :

 Touch the screen the INT section (or long press the 3/INT button on the remote).it display will following menu as below : (touch it again to cancel this function .)

SELECT DIGEST TYPE:
 TRACK DIGEST
 DISC INTERVAL
 TRACK INTERVAL

Use the UP, DOWN, LEFT and RIGHT arrows on the touch screen (or on the remote) to select the item, and then touch the ENT to confirm .

FOR DVD :

 Touch the screen the INT section (or long press the 3/INT button on the remote). it display will following menu as below : (touch it again to cancel this function .)

SELECT DIGEST TYPE:
 TITLE DIGEST
 CHAPTER DIGEST
 TITLE INTERVAL
 CHAPTER INTERVAL

Use the UP, DOWN, LEFT and RIGHT arrows on the touch screen (or on the remote) to select the item, and then touch the ENT to confirm .

NOTE :

The 3/INT button is not available.

DISC Search (GOTO)



 Touch the GOTO section , it display will following as below :

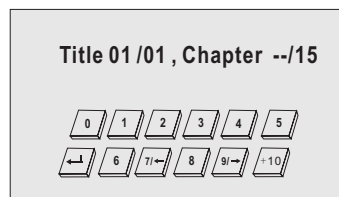

FOR DVD :

 Touch the screen the GOTO range (or press GOTO on the remote) . Twice, the screen will display the following message :

Title 01/01 Time -:-:--
 0:10:36

You can select the item you want to watch through TIME setting by using numeric buttons . (E.x. 0:10:36)



FOR VCD (With PBC OFF):

 Touch the screen the GOTO range (or press GOTO on the remote) . Once, the screen will display the following message :

Disc Go To -:-:--
 0:00:36

Use the numeric buttons to input the time directly (E.x. : 0:00:36)

Note:

Touch and hold the  /  section on the touch screen , you can select the title or chapter of DVD . (Only for the DVD with title /chapter.)

DISC Operation

ON-SCREEN DISPLAY FUNCTION



During playback, touch the screen the OSD section (or press the OSD on the remote), it will display the following as below :

1. DVD:

A. Touch or Press **OSD** for first time:

```
TITLE ELAPSED
TT 01/01 CH 01/38  0:02:06
```

Title Number, Total Title Number, Chapter Number, Total Chapter Number of this Title of the disc currently being played will be shown on the screen, along with the elapsed time.

B. Touch or Press **OSD** for second time:

```
TITLE REMAIN
TT 01/01 CH 01/38  3:24:36
```

C. Touch or Press **OSD** for hird time:

```
CHAPTER ELAPSED
TT 01/01 CH 01/38  0:02:56
```

D. Touch or Press **OSD** for fourth time:

```
CHAPTER REMAIN
TT 01/01 CH 01/38  0:04:32
```

E. Touch or Press **OSD** for fifth time:
The message on the screen will be cleared.

2.Example for VCD/SVCD/CD:

A. Touch or Press **OSD** for first time:

```
SINGLE ELAPSED
TRACK 01/16      0:00:56
```

B. Touch or Press **OSD** for second time:

```
SINGLE REMAIN
TRACK 01/16      0:05:20
```

C. Touch or Press **OSD** for hird time:

```
TOTAL ELAPSED
TRACK 01/16      0:31:32
```

D. Touch or Press **OSD** for fourth time:

```
TOTAL REMAIN
TRACK 01/16      0:36:26
```

E. Touch or Press **OSD** for the fifth time:
The message on the screen will be cleared for SVCD and VCD.

NOTE:

For CD and MP3, the message will always display on the screen.

3.Example for MP3:

Each time **OSD** is pressed or touch , the message displayed on screen changes as follows:



DISC Special Functions

DVD/VCD Special Function



1. Multi-subtitle Language Function (for DVD Only)



During DVD playback. Touch the SUBTITLE section on touch screen (or press the SUBTITLE on the remote). Each time the button is pressed or touch, number of the subtitle language changes in sequential order.

Notes:

- The language number is different according to the disc.
- Some discs only contain one subtitle language.
- When no different subtitle language are recorded, will be displayed at screen left top corner.

2. Multi-Audio Language Function



For DVD: During DVD playback, touch the AUDIO section on touch screen (or press the AUDIO on the remote). Each time the button is pressed or touch, number of the audio soundtrack language changes on sequential order.

Notes:

- The language number is different according to the disc.
- Some disc only contain one language soundtrack
- When no different language soundtrack are recorded will be display at screen left top corner.

For VCD/CD:

during playback, touch the **AUDIO** section of the touch screen or Press **AUDIO** on the remote. It is possible to switch the sound between monaural and stereo sound.



3. Multi-Angle Function (for DVD Only)



During DVD playback, touch the ANGLE section or Press ANGLE button on the remote. Each time the button is pressed or touch, number of the angle changes in sequential order.

Notes:

- The angle number is different according to the disc.
- The function only work for disc having scenes recorded at different angles.
- When no different angle are recorded, will be displayed at screen left top corner.

4. Title Menu Function



For DVD: If the DVD has multiple titles recorded on the disc. It can select preferred title from the title menu to start playback.

- During DVD playback, Touch the **TITLE** section or press TITLE button on the remote. The title menu is display.
- touch the cursor button shown in TV screen, select preferred title by the cursor button and confirmed by touch ENT button.

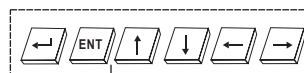

Touch to select

For VCD:

Press **TITLE/PBC** button on the remote control while the disc is playing, you can switch between "PBC on" and "PBC off" mode.

Setup

USING THE MENU

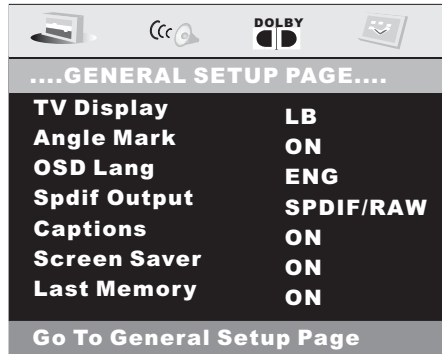

1. Touch the **SET** section of DVD setup on touch screen (or press the SETUP on the remote .)
2. The SETUP menu is displayed.
3. Select the preferred item by touch the range on the screen or by using the ► /◀ /▼ /▲ buttons .
4. Touch the ENT section on screen or Press ENTER button on remote to confirm .

The Following Buttons For Entering The Selection .

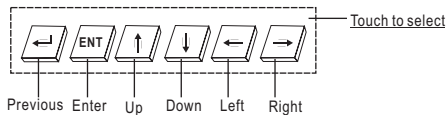

The buttons of the left and right are for selection of setting type .
The buttons of the up and down are for selection of the setting program .

Overview Of The Main Menu

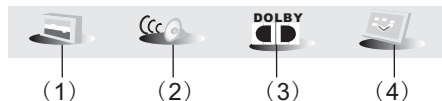

- (1).General Settings
- (2).Speaker Settings
- (3).DOLBY Digital Settings
- (4).Preference Settings

GENERAL SETUP

TV Setting

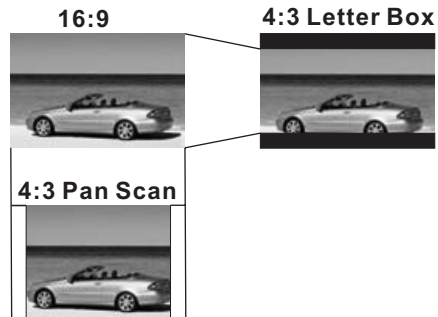
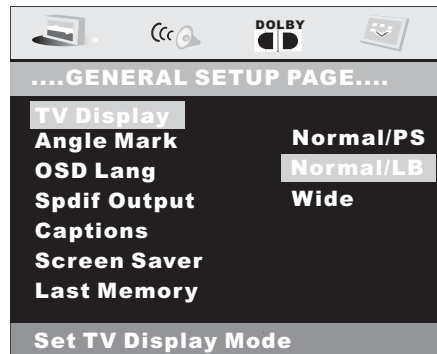

1. TV DISPLAY SETUP

This is to select the appropriate TV aspect (4:3 or 16:9) according to the connected TV set.

Normal/PS (For 4:3 TV)

Played back in the PAN & SCAN style.
(If connected to wide-screen TV, the left and right edges are cut off.)

Normal/LB (For 4:3 TV)

Played back in LETTER BOX style.
(If connected to wide-screen TV, black bands appear at top and bottom of the screen.)

Wide (For 16:9 TV)

Select when a wide-screen TV set is connected.

Setup

GENERAL SETUP

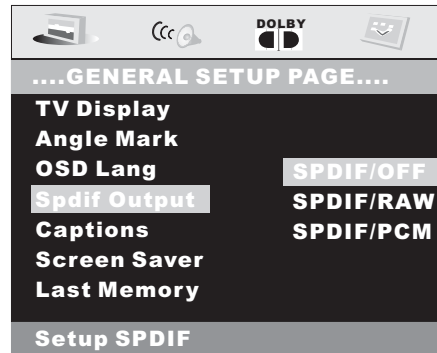
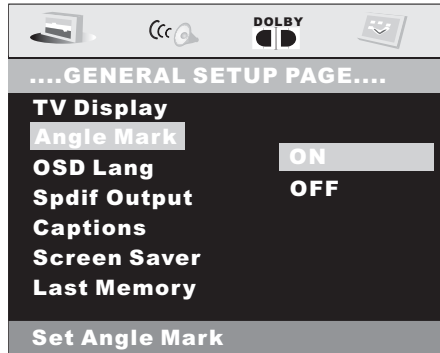

2. ANGLE MARK DISPLAY SETUP

If it is set to ON, when the multi-angle DVD disc is playing,  (the angle mark) will appear on the screen; if it is set to OFF, the mark will not appear.



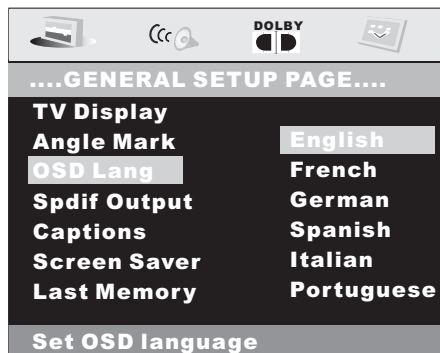

4. SPDIF OUTPUT

This is to activate the audio output from SPDIF OFF mode to SPDIF/RAW mode to SPDIF/PCM mode.

LANGUAGE DISPLAYING



3. OSD LANG TYPE SETUP

Touch the  /  section on the touch screen or press the  /  button on the remote to select the preferred OSD language, then touch the ENT section to confirm.

SUBTITLES HIDING

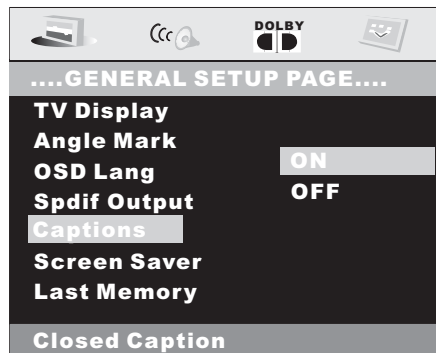

5. CAPTIONS SETUP

Activate the CAPTIONS feature by selecting ON. And release this feature by selecting OFF.

Setup

GENERAL SETUP

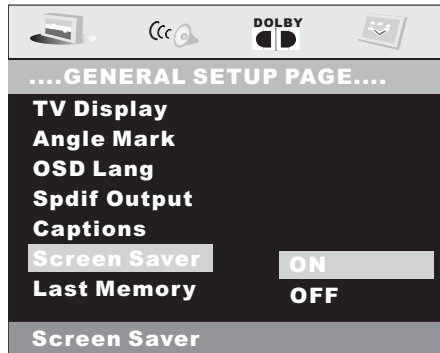

6. SCR SAVER SETUP

Select the SCR SAVER output ON/OFF.

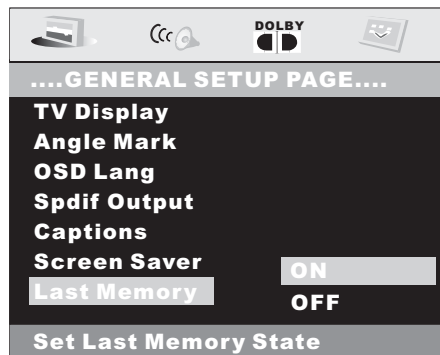

7. LAST MEMORY SETUP

Select the LAST MEMORY output ON/OFF.

SPEAKER SETUP

.....Speaker Setup Page.....

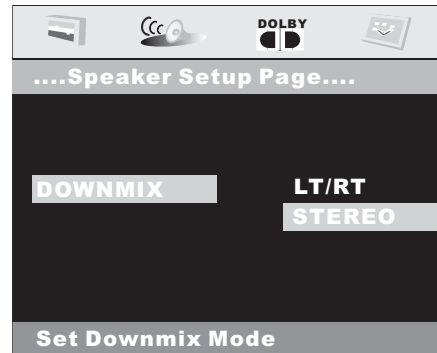

This is to activate the audio output from DOLBY AC3 5.1 DOWNMIX to 2 channel mode. Select the preferred SPEAKER connection by using the cursor buttons. Select the LT/RT to activate the Dolby surround compatible output. Select the STEREO to activate simple stereo mode.

DOLBY DIGITAL SETUP

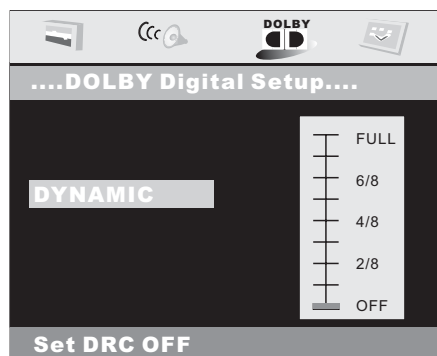

DYNAMIC RANGE CONTROL

Select DRC and adjust the dynamic range of a Doby Digital encoded program. There are 8 steps between full compression and off compression.

Setup

--- PREFERENCES PAGE ---

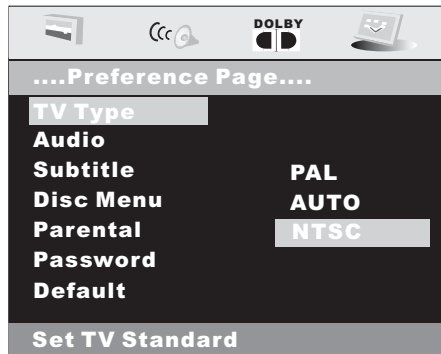

1.TV TYPE SETUP

This player can play discs recorded in either PAL or NTSC format. Select NTSC format, when you connected to NTSC TV. Select PAL format, when you connected to PAL TV. Select AUTO format, the player TV output format will according to the DVD disc format..

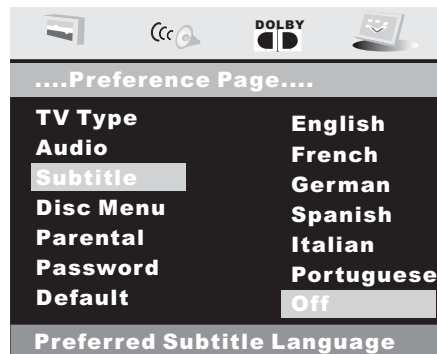

3.SUBTITLE LANGUAGE SETUP

Select the preferred SUBTITLE language by using the cursor buttons.

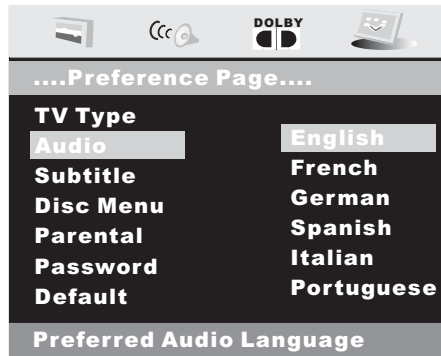

2.AUDIO LANGUAGE SETUP

Select the preferred AUDIO sound-track by using the cursor buttons.



4.DISC MENU LANGUAGE SETUP

Select the preferred DISC MENU language by using the cursor buttons.

Setup

--- PREFERENCES PAGE ---

Age control

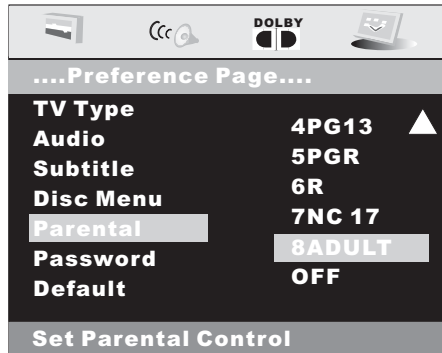

5.PARENTAL

Select suitable parental guidance by the cursor buttons and conformed by pressing ENTER button.

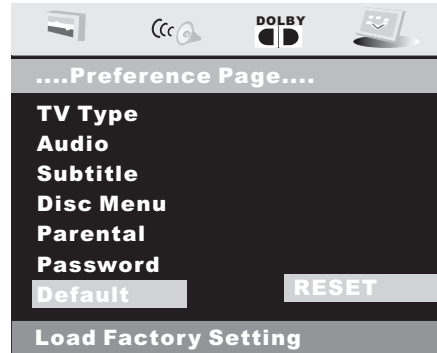

7.DEFAULTS

Select reset to become factory initial setting.

DEFAULTS TABLE

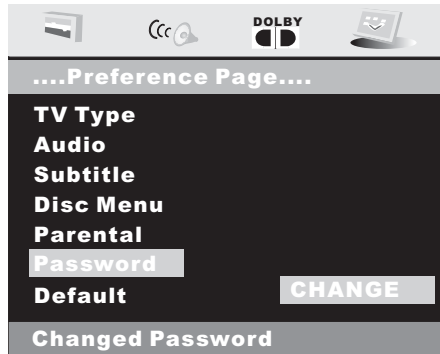

6.PASSWORD

Select the change and press ENTER button. Type the old password (The initial factory code is **1379**) and key in 4 characters password now you want to use, and retype again to confirm key in correctly.

GENERAL SETUP	TV DISPLAY	NORMAL/LB
	ANGLE MARK	ON
	OSD LANGUAGE	ENGLISH
	SPDIF OUPUT	SPDIF/RAM
	CAPTIONS	ON
	SCR SAVER	ON
	LAST MEMORY	ON
SPEAKER SETUP	DOWNMIX	STEREO
DOLBY DIGITAL	DYNAMIC	OFF
PREFERENCES	TV TYPE	AUTO
	AUDIO	ENGLISH
	SUBTITLE	OFF
	DISC MENU	ENGLISH
	PARENTAL	8 ADULT
	PASSWORD	1379

Other Main Operation

USB Operation (17)

Following the diagram below, connect your USB device to the front panel USB port . If it is properly connected, the device will be mounted and start playing automatically.

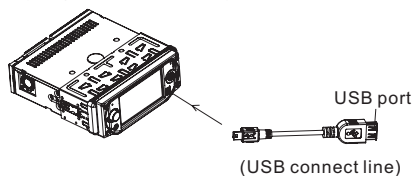

you can also select the desired item of the USB device . The buttons on the remote control, on the device, have the same functions as the touch buttons of this touch screen have .

In USB Playback mode

Use the UP, DOWN, RIGHT or LEFT buttons to navigate to and select files to play, and press ENTER to begin playback (or viewing, in the case of JPEG files). To skip to the next or last track, touch or press the ►► or ◀◀. Press the ►► or ◀◀ buttons for Fast Forward or Fast Reverse playback.

REPEAT play modes are also available by repeatedly pushing **REPEAT** until the desired mode is found.

Changing From USB to DISC Playback Modes

If you are in USB Playback mode and wish to begin playback of a disc already in the player, touch the ■ range on the touch screen or press the STOP on the remote once. Then touch GOTO range on the screen or press the GOTO on the remote and the player will switch to DVD/VCD/CD/MP3 Playback mode.

Changing From DISC to USB Playback Modes

If the disc present in the player is an MP3 disc, touch ■ section on screen or press the STOP on remote once then touch or press the GOTO to USB playback.

If the disc present in the player is an DVD or VCD or CD disc, touch ■ on the screen or press STOP twice on the remote then touch GOTO section on the screen or press the GOTO button on the remote to USB playback.

Important Note:

To prevent damage to the USB device, do not remove or disconnect it during playback. it is also a good practice to remove the USB drive during disc playback.

AUX Operation

To connect analogue replay devices. Use this jack to replay sound of other replay equipment such as DVD players, computers, etc. Via the loudspeakers.



AUX Socket

- 1). Please connect the external device with stereo jack plug the Aux in socket .
- 2). Touch the MOD section on screen or press the MOD button to select the AUX IN connection. It will display the following as below :

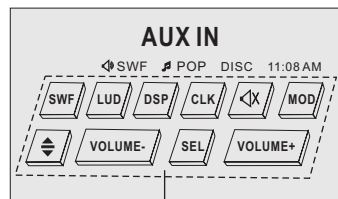

Touch to select

- 3). Touch the volume+/- sections on touch screen or rotate the VOL+/- on the remote to adjust the volume level.

Other Main Operation

MP3/WMA/JPEG/MPEG4 DISC PLAY

1. When inserting an MP3/WMA/JPEG/MPEG4 disc.

Ex: When MP3 file is detected.

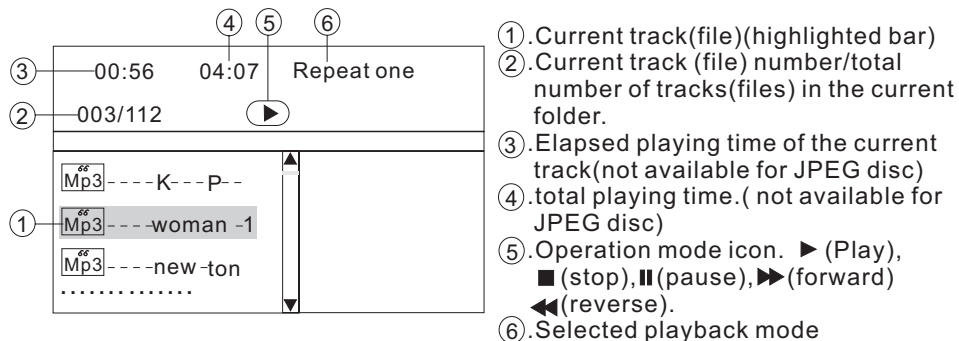

Touch the screen, it will display the following as below :
 (when the parking brake is applied .)

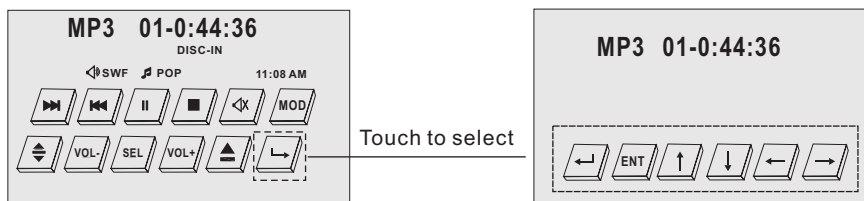

Touch the ↑ / ↓ / ← / → sections on touch screen (or Use ▲ / ▼ / ► / ◀ on remote control) to select the item or folder, then touch the ENT section or press ENTER button on remote to confirm.

Touch the RPT on the touch screen (or Pressing REPEAT button on the remote) repeatedly can select two kinds of repeat play mode.

REP-ONE:

Play the same song over and over again.

REP ALL:

Play all songs in the discover and over again.

In the playback, touch the ►► or ◀◀ section to skip an item ahead or back.

In the playback, touch and hold the ►► / ◀◀ sections on touch screen for about 2 seconds to rapid forward/reverse .

(You can also swing the SEL knob in the direction of ▲ / ▼ button on the front panel and keep more than 2 seconds or short press ►► / ◀◀ on the remote control to rapid forward/reverse.)

Specification

Supply Voltage:	12V DC (11V-15V)		
Current Consumption:	Less than 10 A		
Signal System:	Compositive video 1.0Vp-p 75Ω		
Discs Played:	(1)DVD-VIDEO Disc 5"(12 cm) single-sided, single-layer 5"(12 cm) single-sided, double-layer		
	(2)Compact Disc (CD-DA, VIDEO CD) 5"(12cm) disc		
Audio Signal Output:	2ch&4ch line out		
Characteristics:	(1)Frequency Response	20 Hz - 20 KHz	
	(2)S/N Ratio	90 dB (JIS)	
	(3)Wow and Flutter	Below measurable limits	
	For 3 Bands (Europe) FM	For 2 Bands (Europe) FM	For 2 Bands (U.S.A.) FM
Frequency Coverage:	87.5 to 108 MHz	87.5 to 108 MHz	87.5 to 107.9 MHz
IF:	10.7 MHz	10.7 MHz	10.7 MHz
Sensitivity (S/N = 30 dB):	15 dBu	15 dBu	15dBu
	MW	MW	AM
Frequency Coverage:	522 to 1620 KHz	522 to 1620 KHz	530 to 1710 KHz
IF:	450 KHz	450 KHz	450 KHz
Sensitivity (S/N = 20 dB):	40 dBu	40 dBu	40 dBu
	LW(Optional)		
Frequency Coverage:	144 to 290 KHz		
IF:	450 KHz		
Sensitivity (S/N = 20 dB):	45 dBu		
Monitor Screen Size:	4.3 Inch Wide		
Number of Pixels:	480 X 3(RGB) X 272 pixels		
Color System:	NTSC/PAL		

NOTE: Specifications and design are subject to modification, without notice, due to improvements in technology.

Trouble Shooting

Before going through the check list, check wiring connection. If any of the problems persist after check list has been made, consult your nearest service dealer.

SYMPTOM	CAUSE	SOLUTION
No power	The car ignition switch is not on	If the power supply is properly connected to the car accessory terminal, switch the ignition key to "ACC"
	The fuse is blown	Replace the fuse
Disc can not be loaded or ejected	Presence of disc inside the player.	Remove the disc in the player, then put a new one
	Inserting the disc in reverse direction	Insert the compact disc with the label facing upward
	The disc is extremely dirty or defective	Clean the disc or try to play a new one
	Temperature inside the car is too high	Cool off or until the ambient temperature return to normal
Television/video image appears black-white	The color system is set incorrectly	Please switch to correct color system from menu
No television/video image appears	The unit is not connected to the parking brake detection switch	Make proper connection according to "wire connection"
	The parking brake is not engaged	For safety reasons no television /video images are displayed while the vehicle is moving. Engaging the parking brake will cause images to be displayed.
No color in picture	The disc format is not according to the TV-set used (PAL/NTSC)	Please the television mode of the choice accommodation
JPEG disc can not be played back	No JPEG files are recorded on the disc.	Change the disc
	JPEG files are not recorded in a compliant format	Change the disc Record JPEG files using a compliant application
The operation keys do not work	The built-in microcomputer is not operating properly due to noise	Press the RESET button. Front panel is not properly fixed into its place
The radio does not work	The antenna cable is not connected	Insert the antenna cable firmly
	The signals are too weak	Select a station manually