



Makita Miter Saw

255 mm (10") MODEL LS1000
Equipped with Electrical Blade Brake

アメリカ

INSTRUCTION MANUAL



 **DOUBLE INSULATION**

SPECIFICATIONS

Blade diameter	Hole diameter	Max. cutting capacities (H x W)		No load speed	Dimensions (L x W x H)	Net weight
		Cross cut (0°)	Miter cut (45°)			
255 mm (10")	15.88 mm and 25 mm (5/8" and 31/32")	70 mm x 122 mm (2 3/4" x 4 3/4")	70 mm x 90 mm (2-3/4" x 3-1/2")	4,100 R/min.	496 mm x 470 mm x 442 mm (19-1/2" x 18-1/2" x 17-3/8")	18.0 kg (40 lbs)

- * Manufacturer reserves the right to change specifications without notice.
- * Note: Specifications may differ from country to country.

BEFORE CONNECTING YOUR TOOL TO A POWER SOURCE

**Be sure you have read all
GENERAL POWER TOOL SAFETY RULES**

GENERAL SAFETY PRECAUTIONS (For All Tools)

- 1. KNOW YOUR POWER TOOL.** Read the owner's manual carefully. Learn the tools applications and limitations, as well as the specific potential hazards peculiar to it.
- 2. KEEP GUARDS IN PLACE** and in working order.
- 3. REMOVE ADJUSTING KEYS AND WRENCHES.** Form habit of checking to see that keys and adjusting wrenches are removed from tool before turning it on.
- 4. KEEP WORK AREA CLEAN.** Cluttered areas and benches invite accidents.
- 5. DON'T USE IN DANGEROUS ENVIRONMENT.** Don't use power tools in damp or wet locations, or expose them to rain. Keep work area well lighted.
- 6. KEEP CHILDREN AWAY.** All visitors should be kept safe distance from work area.
- 7. MAKE WORKSHOP KID PROOF** with padlocks, master switches, or by removing starter keys.
- 8. DON'T FORCE TOOL.** It will do the job better and safer at the rate for which it was designed.
- 9. USE RIGHT TOOL.** Don't force tool or attachment to do a job for which it was not designed.
- 10. WEAR PROPER APPAREL.** Wear no loose clothing, gloves, neckties, rings, bracelets, or other jewelry which may get caught in moving parts. Nonslip footwear is recommended. Wear protective hair covering to contain long hair.
- 11. ALWAYS USE SAFETY GLASSES.** Also use face or dust mask if cutting operation is dusty. Everyday eyeglasses only have impact resistant lenses, they are NOT safety glasses.
- 12. SECURE WORK.** Use clamps or a vise to hold work when practical. It's safer than using your hand and it frees both hands to operate tool.
- 13. DON'T OVERREACH.** Keep proper footing and balance at all times.
- 14. MAINTAIN TOOLS WITH CARE.** Keep tools sharp and clean for best and safest performance. Follow instructions for lubricating and changing accessories.
- 15. DISCONNECT TOOLS** before servicing; when changing accessories such as blades, bits, cutters, and the like.

16. **REDUCE THE RISK OF UNINTENTIONAL STARTING.** Make sure switch is in off position before plugging in.
17. **USE RECOMMENDED ACCESSORIES.** Consult the owner's manual for recommended accessories. The use of improper accessories may cause risk of injury to persons.
18. **NEVER STAND ON TOOL.** Serious injury could occur if the tool is tipped or if the cutting tool is accidentally contacted.
19. **CHECK DAMAGED PARTS.** Before further use of the tool, a guard or other part that is damaged should be carefully checked to determine that it will operate properly and perform its intended function — check for alignment of moving parts, binding of moving parts, breakage of parts, mounting, and any other conditions that may affect its operation. A guard or other part that is damaged should be properly repaired or replaced.
20. **DIRECTION OF FEED.** Feed work into a blade or cutter against the direction of rotation of the blade or cutter only.
21. **NEVER LEAVE TOOL RUNNING UNATTENDED. TURN POWER OFF.** Don't leave tool until it comes to a complete stop.
22. This tool is intended for residential use only.
23. When servicing use only identical replacement parts.

VOLTAGE WARNING: Before connecting the tool to a power source (receptacle, outlet, etc.) be sure the voltage supplied is the same as that specified on the nameplate of the tool. A power source with voltage greater than that specified for the tool can result in **SERIOUS INJURY** to the user — as well as damage to the tool. If in doubt, **DO NOT PLUG IN THE TOOL.** Using a power source with voltage less than the nameplate rating is harmful to the motor.

ADDITIONAL SAFETY RULES

1. Don't use the tool in the presence of flammable liquids or gases.
2. Check the blade carefully for cracks or damage before operation. Replace cracked or damaged blade immediately.
3. Use only flanges specified for this tool.
4. Be careful not to damage the arbor, flanges (especially the installing surface) or bolt. Damage to these parts could result in blade breakage.
5. Make sure that the turn base is properly secured so it will not move during operation.
6. Always keep the table top clear of chips, small pieces and so on in order to maintain a safe, clean surface.
7. Avoid cutting nails. Inspect for and remove all nails from the workpiece before operation.
8. Make sure the shaft lock is released before the switch is turned on.
9. Be sure that the blade does not contact the turn base in the lowest position.
10. Hold the handle firmly.
11. Keep hands away from rotating parts.
12. Make sure the blade is not contacting the workpiece before the switch is turned on.
13. Before using the tool on an actual workpiece, let it run for a while. Watch for vibration or wobbling that could indicate poor installation or a poorly balanced blade.
14. Wait until the blade attains full speed before cutting.
15. Stop operation immediately if you notice anything abnormal.
16. Do not attempt to lock the trigger in the on position.
17. Always switch off and wait for the blade to come to a complete stop before removing, securing workpiece, changing workpiece position, angle or the blade itself.
18. Don't abuse cord. Never yank cord to disconnect it from the receptacle. Keep cord away from heat, oil, water and sharp edges.

WARNING

For Your Own Safety Read Instruction Manual Before Operating Miter Saw

1. Wear eye protection.
2. Keep hands out of path of saw blade.
3. Do not operate saw without guards in place.
4. Do not perform any operation freehand.
5. Never reach around saw blade.
6. Shut off power and wait for saw blade to stop before servicing or adjusting tool.

SAVE THESE INSTRUCTIONS.

HOW TO USE

Handle latch

This tool is equipped with a handle latch which is used to lock the handle in the lowered position. To release from the lowered position, lower the handle slightly and turn the handle latch to the released position. To lock the handle in the lowered position, lower the handle fully and turn the handle latch to the locked position. When carrying the tool, lock the handle in the lowered position and secure the turn base by means of the grip.

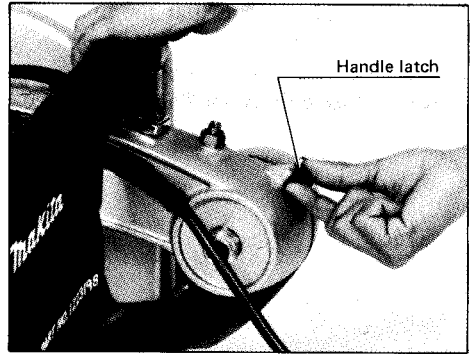

Fig. 1

Bench mounting miter saw

This tool should be bolted with two bolts to a level and stable surface using the bolt holes provided in the tool's base.

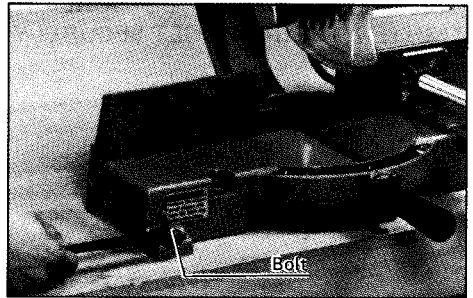

Fig. 2

Removing or installing saw blade

First, be sure to unplug the tool from the power source.

Loosen the screw holding the center cover.

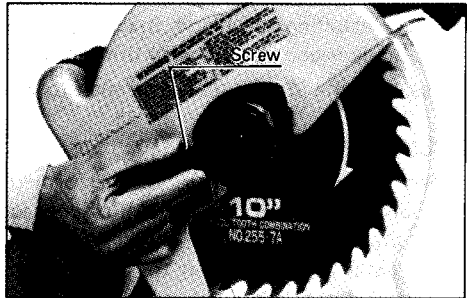

Fig. 3

Raise the safety cover and center cover.



Fig. 4

Press the shaft lock so that the blade cannot revolve and use the socket wrench to loosen the hex bolt clockwise. Then remove the hex bolt, outer flange and blade.

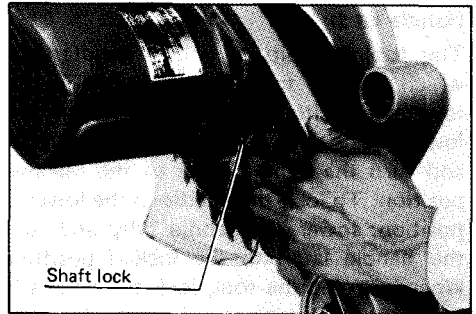

Fig. 5

To install the blade, follow the removal procedure in reverse. **BE SURE TO TIGHTEN THE HEX BOLT SECURELY.**

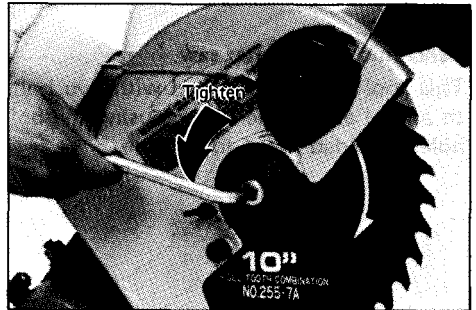

Fig. 6

CAUTION:

- When installing the blade, make sure that the direction of the arrow on the surface of the blade is compatible with that on the blade case.
- Use only the Makita socket wrench to install or remove the blade.

Safety cover

When cutting operations are performed, the safety cover rises as a result of contact with the workpiece. The cover returns to its original position when the cut is completed and the handle is raised. **NEVER DEFEAT OR REMOVE THE SAFETY COVER.** In the interest of your personal safety, always maintain the safety cover in a freely moving condition. Any irregular operation of the safety cover should be corrected immediately. **NEVER USE THE TOOL WITH A FAULTY SAFETY COVER.** If the see-through safety cover becomes dirty, or sawdust adheres to it in such a way that the blade and/or workpiece is no longer easily visible; unplug the saw and clean the cover carefully with a damp cloth. Do not use solvents or any petroleum-based cleaners on the plastic cover.

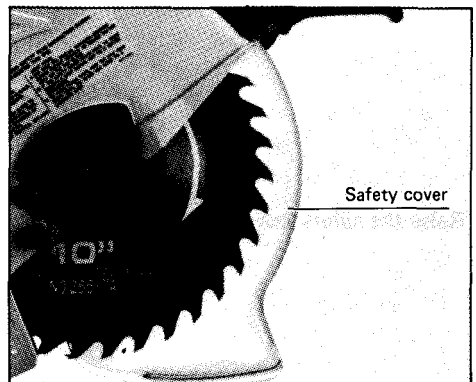

Fig. 7

Maintaining maximum cutting capacity

Unplug the tool before any adjustment is attempted.

This tool is factory adjusted to provide the max. cutting capacity for a 255 mm (10") saw blade. When the diameter of the blade has been reduced due to sharpening, loosen the hex nut at the rear of the gear housing. Use a screwdriver to adjust the depth adjusting bolt. The saw blade is lowered by turning the depth adjusting bolt counterclockwise and raised by turning it clockwise. Adjust so that when the handle is in the fully lowered position, there will be a distance of about 122 mm (4-3/4") from the front face of the guide fence to the point where the front edge of the blade enters the kerf. Now tighten the hex nut with the wrench while carefully holding the adjusting bolt in position with the screwdriver.

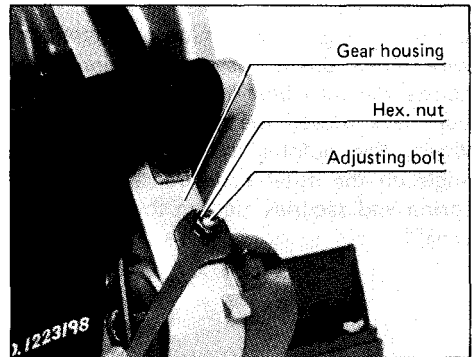

Fig. 8

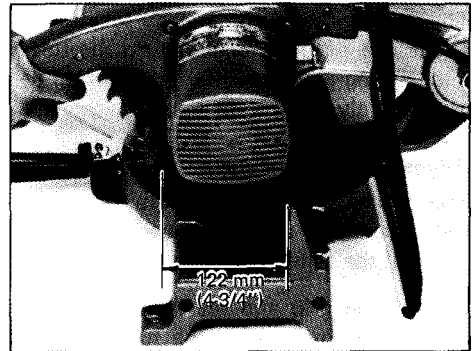

Fig. 9

Adjusting for smooth handle action

The hex lock nut holding together the gear housing and arm has been factory adjusted to assure smooth handle action up and down and to guarantee precise cutting. Do not tamper with it.

Should looseness develop at the gear housing and arm connection, perform the following adjustment. Work the handle up and down while tightening the hex lock nut; the best position to tighten the hex lock nut is just before the motor body weight is obvious.

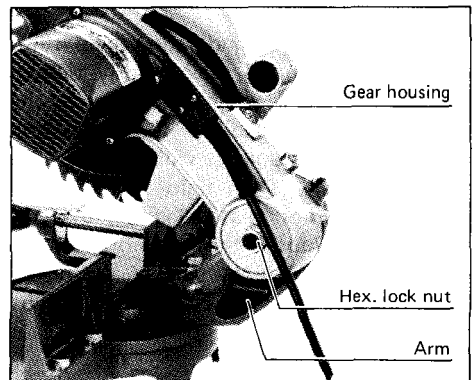

Fig. 10

After adjusting the hex lock nut, be sure the handle returns automatically to the initial position from any position. If the hex lock nut is too loose, the cutting accuracy will be affected; if it is too tight, it will be hard to work the handle up and down. Note that this is a self locking nut; it is a special type that does not loose in normal use. It should not be overtightened or replaced with other types of nuts.

Positioning for miter angle

Loosen the grip by turning counterclockwise. Press down the latch spring. This allows the turn base to turn freely. When you have moved the grip to the position where the pointer indicates the desired angle on the miter scale, release the latch spring and securely tighten the grip clockwise.

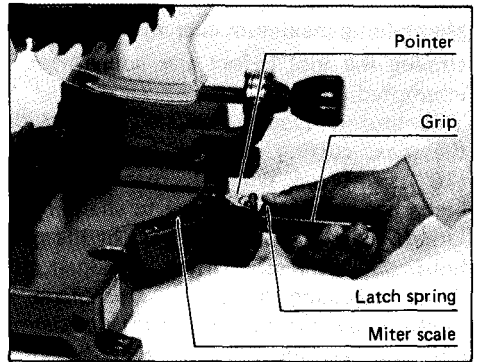

Fig. 11

NOTE:

The latch spring automatically locates miter angles of 0, 15, 22.5, 30 and 45 degrees. To select one of these angles, turn the turn base near the desired angle while releasing the latch spring and allow the latch spring to seat itself in the miter notch. Then tighten the grip securely.

Alignment for squareness

This tool was carefully adjusted and aligned for squareness of cut at the factory, but rough handling may have affected the alignment. If your tool is not aligned properly, perform the following.

Loosen the grip and set the turn base at zero degree by turning the turn base and allowing the latch spring to seat itself in the miter notch.

If the pointer on the indication plate is not at zero on the miter scale, gently tighten the grip and then loosen the screws on the indication plate. Adjust the indication plate so that the pointer will be at zero on the miter scale. Then tighten the screws on the indication plate. Tighten the grip securely and loosen the hex bolts on the guide fence.

Square the side of the blade with the side of the guide fence using a ruler (try-square or the like). Then securely tighten the hex bolts on the guide fence.

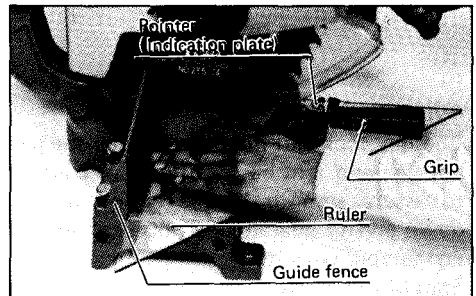

Fig. 12

Attaching dust bag

The use of the dust bag makes cutting operations clean and dust collection easy. To attach the dust bag, fit it onto the dust nozzle of the blade case.



Fig. 13

Emptying dust bag

When the dust bag is about half full, remove the dust bag from the tool and pull the fastener out. Empty the dust bag of its contents, tapping it lightly so as to remove particles adhering to the insides which might hamper collection.

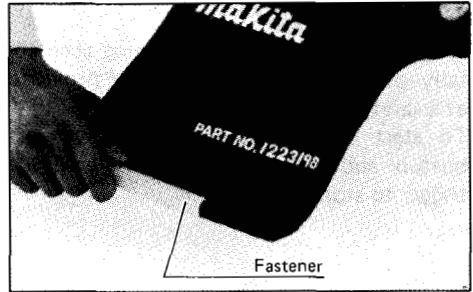

Fig. 14

Securing workpiece

By turning the knob on the vise counterclockwise, the screw is released and the vise shaft can be moved rapidly in and out. By turning the knob clockwise, the screw remains secured. To grip workpieces, turn the knob gently clockwise, until the projection reaches its topmost position, then fasten securely. If the knob is forced in or pulled out while being turned clockwise, the projection may stop at an angle. In this case, turn the knob back counterclockwise until the screw is released, before turning again gently clockwise.

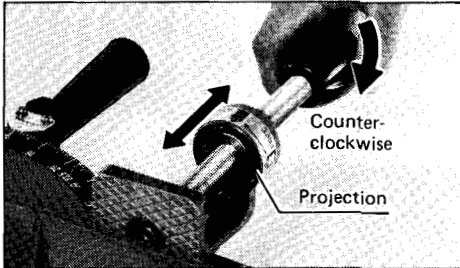

Fig. 15

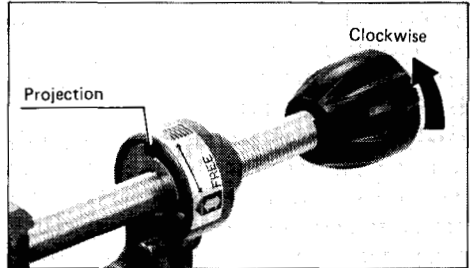
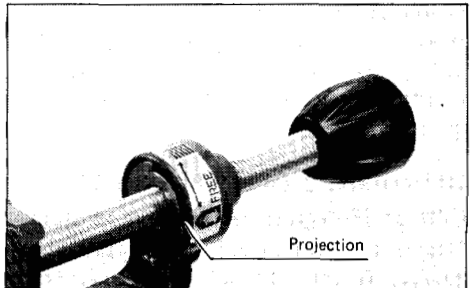

Fig. 16

CAUTION:

- Grip workpieces only when the projection is at the topmost position. Otherwise the workpiece cannot be properly gripped and might pop out or damage the blade.



(Dangerous way to grip workpiece)

Fig. 17

- When making miter cuts of 35 degrees or more, to the side that the vise is mounted, the safety cover movement may be slightly obstructed by the vise. This only occurs when the workpiece dimensions are more than 90 mm (3-1/2") in width and less than 60 mm (2-3/8") in height, or less than 90 mm (3-1/2") in width and less than 30 mm (1-3/16") in height. If this situation occurs, re-mount the vise on the other side of the tool's base.

Switch action

To prevent the trigger from being accidentally pulled, a lock-off button is provided as a safety feature.

To start the tool, press in the lock-off button and pull the trigger. Release the trigger to stop.

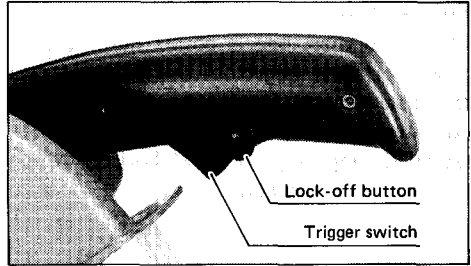

Fig. 18

CAUTION:

- Before plugging in the tool, always check to see that the trigger switch actuates properly and returns to the "OFF" position when released.
- When not using the tool, remove the lock-off button. This prevents unauthorized operation.

Operation

When cutting with this tool, the thickness of the blade is cut as well. Therefore, your cutting line should be on either the left or right side of the groove in the kerf board. Switch on the tool and wait until the blade attains full speed before lowering gently into the cut. When the blade contacts the workpiece, gradually bear down on the handle to perform the cut. When the cut is completed, switch off the tool and **WAIT UNTIL THE BLADE HAS COME TO A COMPLETE STOP** before returning the blade to its fully elevated position. A thin-cut piece could otherwise contact the coasting blade and be thrown around dangerously.

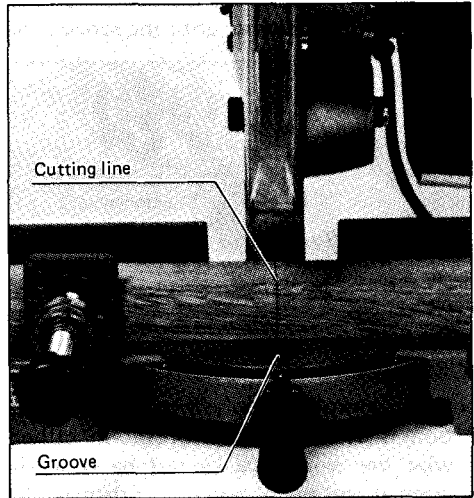

Fig. 19

When cutting 2 x 4 (1-5/8" x 3-1/2")

Cuts of 45 degrees can be done as usual as long as the workpiece is not positioned vertically. To cut vertically positioned workpiece, insert a space block or scrap of wood measuring 1/2" (12 mm) in thickness between the workpiece and the guide fence.

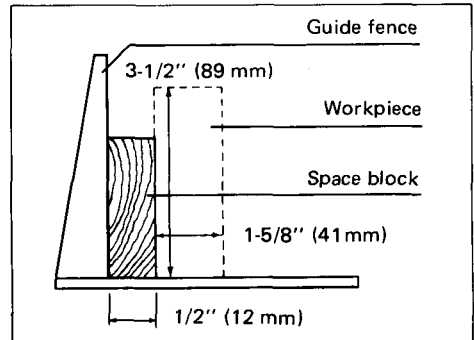

Fig. 20

Carrying tool

When carrying the tool, lower the handle fully and turn the handle latch to the locked position. Also secure the turn base by means of the grip. The tool can then be conveniently carried by the carrying handle.

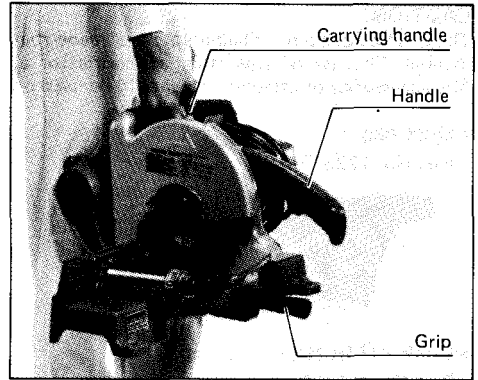

Fig. 21

MAINTENANCE

CAUTION:

Always be sure that the tool is switched off and unplugged before attempting to perform inspection or maintenance.

Replacing carbon brushes

Remove and check the carbon brushes regularly. Replace when they wear down to about 6 mm (1/4") or less. Keep the carbon brushes clean and free to slip in the holders. Both carbon brushes should be replaced at the same time. Use only Makita carbon brushes.

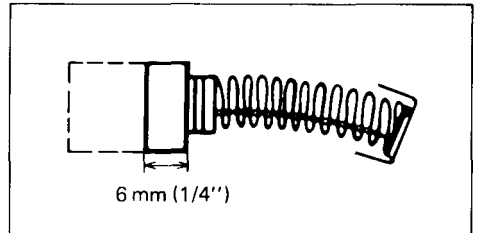

Fig. 22

Use a screwdriver to remove the brush holder caps. Take out the worn carbon brushes, insert the new ones and secure the brush holder caps.

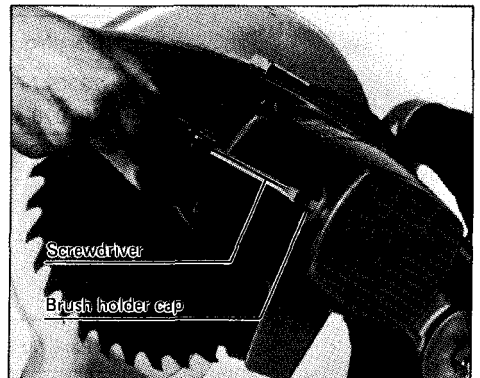

Fig. 23

To maintain product SAFETY and RELIABILITY, repairs, any other maintenance or adjustment should be performed by Makita Authorized or Factory Service Centers, always using Makita replacement parts.

ACCESSORIES

CAUTION:

These accessories or attachments are recommended for use with your Makita tool specified in this manual. The use of any other accessories or attachments might present a risk of injury to persons. The accessories or attachments should be used only in the proper and intended manner.

• Dust bag

Part No. 122319-8



• Socket wrench 13

Part No. 782212-4



• Lock-off button 2 pcs.

Part No. 411478-6



• Ring (16)

Part No. 257022-3

For a 25 mm (31/32") arbor hole



• Saw blades

Chisel tooth combination saw blade



For rip and cross-cut work.

Most frequently used for general carpentry.

Part No.	NO.	Dia. (mm)	Hole dia. (mm)	No. teeth
792317-2	255-7A	255 (10")	15.88 (5/8")	36

Miter saw blade



For smooth cutting of wood.

Part No.	NO.	Dia. (mm)	Hole dia. (mm)	No. teeth
792077-6	255-4	255 (10")	25 (31/32")	100
792078-4	*255-4A	255 (10")	25 (31/32")	100

* When cutting aluminum, use a cutting lubricant.

Carbide-tipped saw blade

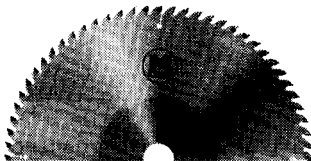

Fast, smoother, longer sawing without blade sharpening. Cuts wood, dry wall, plastics.

Part No.	NO.	Dia. (mm)	Hole dia. (mm)	No. teeth
792200-3	255-11D	255 (10")	15.88 (5/8")	50
792303-3	*255-11C	255 (10")	15.88 (5/8")	70

* ... For aluminum cutting.



255 mm (10'')

MITER SAW

Model LS1000

Type1

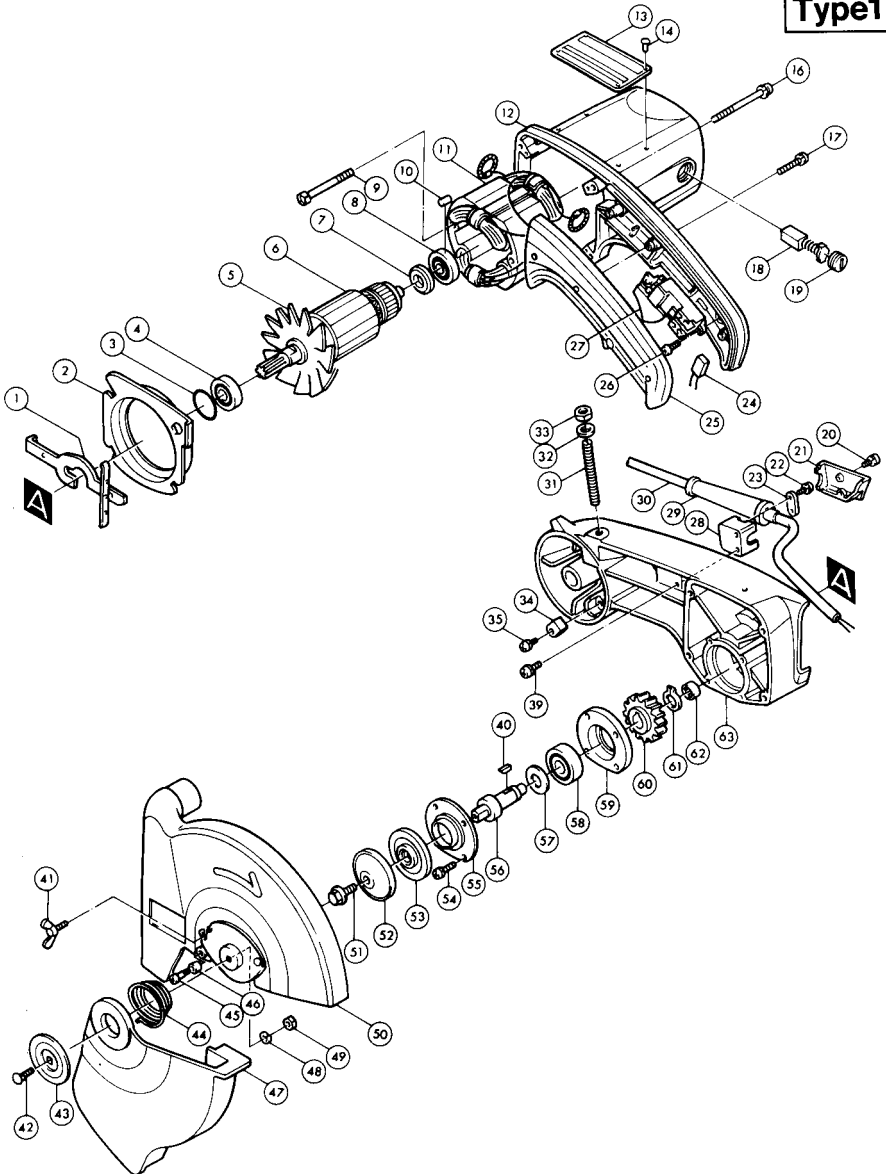

Type1

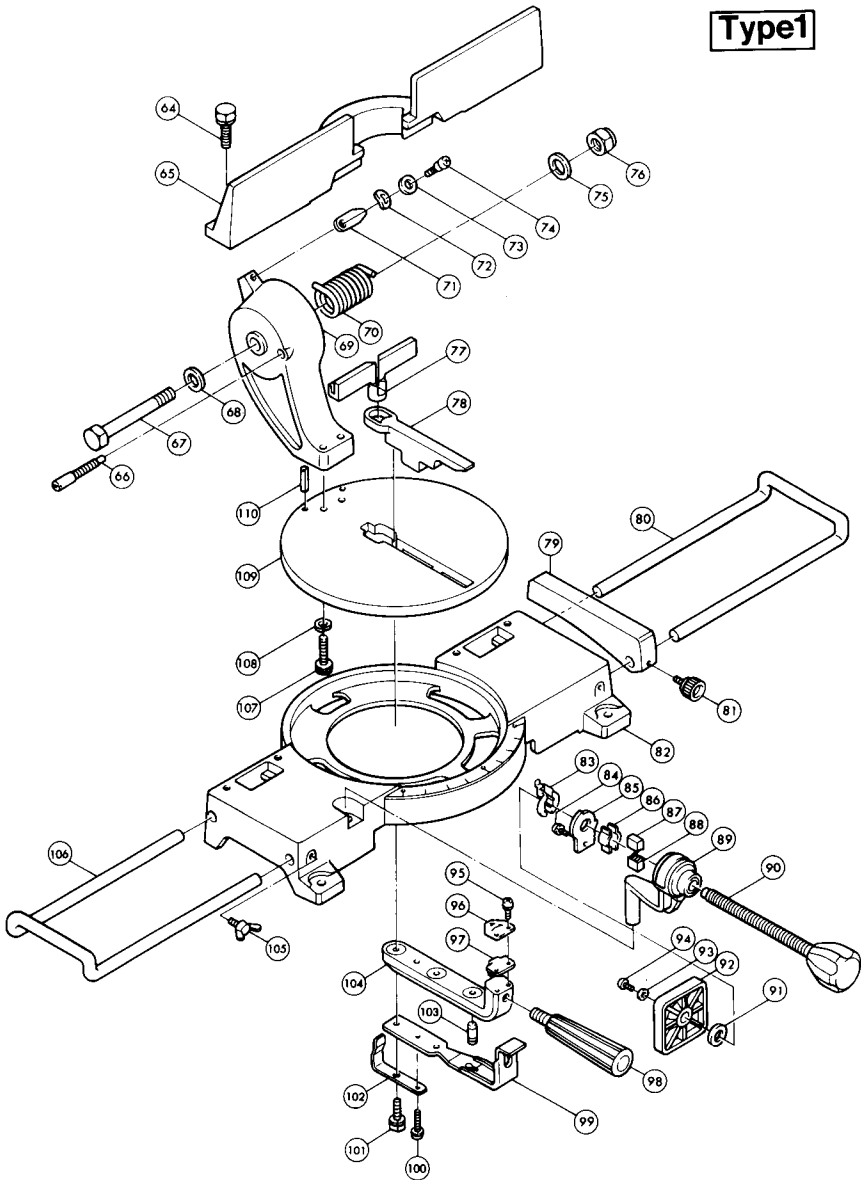

Note: The switch, noise suppressor and other part configurations may differ from country to country.

ITEM NO.	NO. USED	DESCRIPTION	ITEM NO.	NO. USED	DESCRIPTION
<u>MACHINE</u>			<u>MACHINE</u>		
1	1	Spindle Lock (Shaft Lock)	58	1	Ball Bearing 6203LLB
2	1	Baffle Plate	59	1	Bearing Box
3	1	O Ring 32	60	1	Helical Gear 41
4	1	Ball Bearing 6201LLB	61	1	Retaining Ring S—17
5	1	Fan 92	62	1	Needle Bearing 1210
6	1	ARMATURE ASSEMBLY (With Item 5 — 8)	63	1	Gear Housing
7	1	Insulation Washer	64	4	Hex. Bolt M10x25 (With Washer)
8	1	Ball Bearing 6200LB	65	1	Guide Rule (Guide Fence)
9	2	+ Hex. Bolt M5x65 (With Washer)	66	1	Set Screw M10
10	1	Rubber Pin 4	67	1	Hex. Bolt M16
11	1	FIELD ASSEMBLY	68	1	Flat Washer 16
12	1	Motor Housing	69	1	Arm
13	1	Name Plate	70	1	Torsion Spring 32
14	4	Rivet 0—5	71	1	Stopper
16	4	Pan Head Screw M5x75 (With Washer)	72	1	Wave Washer 8
17	3	Pan Head Screw M4x30 (With Washer)	73	1	Thin Washer 8
18	2	Carbon Brush	74	1	+ Pan Head Screw M6
19	2	Brush Holder Cap	75	1	Flat Washer 16
20	2	Pan Head Screw M4x16 (With Washer)	76	1	Hex. Nut M16—24
21	1	Clamp Cover	77	1	Chip Deflector
22	2	Pan Head Screw M4x18 (With Washer)	78	1	Kerf Board
23	1	Strain Relief	79	1	Set Plate
24	1	Noise Suppressor	80	1	Holder
25	1	Handle Cover	81	1	Screw M6x12
26	1	Pan Head Screw M4x6 (With Washer)	82	1	Base
27	1	Switch	83	1	Nut Holder
28	1	Clamp Base	84	1	Pan Head Screw M5x14 (With Washer)
29	1	Cord Guard	85	1	Set Plate
30	1	Cord	86	2	Protector
31	1	Screw M10x70	87	1	Release Nut R
32	1	Flat Washer 10	88	1	Release Nut L
33	1	Hex. Nut M10	89	1	Vice Arm
34	1	Cushion	90	1	Knob 45
35	1	Pan Head Screw M5x22 (With Washer)	91	1	Flat Washer 12
39	2	Pan Head Screw M4x14 (With Washer)	92	1	Vice Plate
40	1	Key 4	93	1	Flat Washer 6
41	1	Wing Bolt M5x12	94	1	Pan Head Screw M6x14
42	1	Cap Square Neck Bolt M5x8	95	2	Pan Head Screw M4x8 (With Washer)
43	1	Plate	96	1	Indication Label
44	1	Spring 26	97	1	Plate
45	1	+ Pan Head Screw M5	98	1	Grip 32
46	1	Rubber Sleeve 6	99	1	Knock Spring
47	1	Safety Cover	100	1	Pan Head Screw M5x30 (With Washer)
48	1	Spring Washer 5	101	2	Hex. Bolt M8x25 (With Washer)
49	1	Hex. Nut M5	102	1	Leaf Stay
50	1	Blade Case	103	1	Knock Pin
51	1	Hex. Flange Head Bolt M8x20	104	1	Turning Stay
52	1	Outer Flange 55	105	2	Wing Bolt M6x12
53	1	Inner Flange 55	106	1	Holder
54	4	Pan Head Screw M5x20 (With Washer)	107	2	Hex. Socket Head Bolt M10x35
55	1	Bearing Retainer 71	108	2	Spring Washer 10
56	1	Spindle	109	1	Turn Base
57	1	Thin Washer 17	110	2	Spring Pin 5—18

Note: The switch, noise suppressor and other part specifications may differ from country to country.

7 x 11

MAKITA LIMITED ONE YEAR WARRANTY

Warranty Policy

Every Makita tool is thoroughly inspected and tested before leaving the factory. It is warranted to be free of defects from workmanship and materials for the period of ONE YEAR from the date of original purchase. Should any trouble develop during this one-year period, return the COMPLETE tool, freight prepaid, to one of Makita's Factory or Authorized Service Centers. If inspection shows the trouble is caused by defective workmanship or material, Makita will repair (or at our option, replace) without charge.

This Warranty does not apply where:

- repairs have been made or attempted by others;
- repairs are required because of normal wear and tear;
- The tool has been abused, misused or improperly maintained;
- alterations have been made to the tool.

IN NO EVENT SHALL MAKITA BE LIABLE FOR ANY INDIRECT, INCIDENTAL OR CONSEQUENTIAL DAMAGES FROM THE SALE OR USE OF THE PRODUCT. THIS DISCLAIMER APPLIES BOTH DURING AND AFTER THE TERM OF THIS WARRANTY.

MAKITA DISCLAIMS LIABILITY FOR ANY IMPLIED WARRANTIES, INCLUDING IMPLIED WARRANTIES OF "MERCHANTABILITY" AND "FITNESS FOR A SPECIFIC PURPOSE," AFTER THE ONE-YEAR TERM OF THIS WARRANTY.

This Warranty gives you specific legal rights, and you may also have other rights which vary from state to state. Some states do not allow the exclusion or limitation of incidental or consequential damages, so the above limitation or exclusion may not apply to you. Some states do not allow limitation on how long an implied warranty lasts, so the above limitation may not apply to you.



Makita Electric Works, Ltd.

11-8, 3-chome, Sumiyoshi-cho, Anjo, Aichi 446, Japan

883475A068

PRINTED IN JAPAN

1986 - 3 - N