

JVC



VIDEO CASSETTE RECORDER

HR-J241MS

ENGLISH

CONTENTS

SAFETY FIRST	2
Safety Precautions	2
INSTALLING YOUR NEW RECORDER	3
Basic Connections	3
INITIAL SETTINGS	4
Auto Set Up	4
Video Channel Set	5
Select Language	6
Select Television System	7
Clock Set	8
On-Screen Displays	9
PLAYBACK	10
Basic Playback	10
Playback Features	11
RECORDING	14
Basic Recording	14
Recording Features	15
TIMER RECORDING	16
Timer Programming	16
EDITING	20
Edit To Or From Another Video Recorder	20
Edit From A Camcorder	21
INFORMATION ON MULTI-SYSTEM COMPATIBILITY	22
TUNER SET	24
TROUBLESHOOTING	28
QUESTIONS AND ANSWERS	30
INDEX	31
SPECIFICATIONS	34

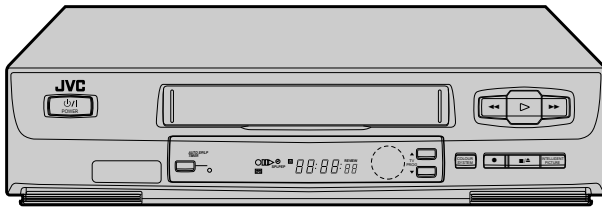
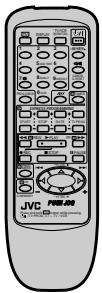

INSTRUCTIONS



EN

Safety Precautions

The rating plate and the safety caution are on the rear of the unit.

WARNING: DANGEROUS VOLTAGE INSIDE

WARNING: TO PREVENT FIRE OR SHOCK HAZARD, DO NOT EXPOSE THIS UNIT TO RAIN OR MOISTURE.

CAUTION

- When you are not using the recorder for a long period of time, it is recommended that you disconnect the power cord from the mains outlet.
- Dangerous voltage inside. Refer internal servicing to qualified service personnel. To prevent electric shock or fire hazard, remove the power cord from the mains outlet prior to connecting or disconnecting any signal lead or aerial.

ATTENTION

1. This recorder can also receive SECAM colour television signals for recording and playback.
2. Recordings made of SECAM television signals produce monochrome pictures if played back on another video recorder of SECAM standard, or do not produce normal colour pictures if played back on another video recorder of PAL standard.
3. SECAM prerecorded cassettes or recordings made with a SECAM video recorder produce monochrome pictures when played back with this recorder.

POWER SYSTEM

This set operates on voltage of AC110 – 240 V \sim (Rating), AC90 – 260 V \sim (Operating), 50/60 Hz with automatic switching.

Warning on lithium battery

- The battery used in this device may present a fire or chemical burn hazard if mistreated. Do not recharge, disassemble, heat above 100°C or incinerate. Replace battery with Panasonic (Matsushita Electric), Sanyo, Sony or Maxell CR2025; use of another battery may present a risk of fire or explosion.
- Dispose of used battery promptly.
 - Keep away from children.
 - Do not disassemble and do not dispose of in fire.

IMPORTANT

- Please read the various precautions on this page before installing or operating the recorder.
- It should be noted that it may be unlawful to re-record pre-recorded tapes, records, or discs without the consent of the owner of copyright in the sound or video recording, broadcast or cable programme and in any literary, dramatic, musical, or artistic work embodied therein.

The POWER \cup /I button does not completely shut off mains power from the unit, but switches operating current on and off. " \cup " shows electrical power standby and " I " shows ON.

Video tapes recorded with this video recorder in the LP (Long Play) or EP (Extended Play) mode cannot be played back on a single-speed video recorder.

Failure to heed the following precautions may result in damage to the recorder, remote control or video cassette.

1. **DO NOT** place the recorder . . .
 - ... in an environment prone to extreme temperatures or humidity.
 - ... in direct sunlight.
 - ... in a dusty environment.
 - ... in an environment where strong magnetic fields are generated.
 - ... on a surface that is unstable or subject to vibration.
2. **DO NOT** block the recorder's ventilation openings.
3. **DO NOT** place heavy objects on the recorder or remote control.
4. **DO NOT** place anything which might spill on top of the recorder or remote control.
5. **AVOID** violent shocks to the recorder during transport.

MOISTURE CONDENSATION

Moisture in the air will condense on the recorder when you move it from a cold place to a warm place, or under extremely humid conditions—just as water droplets form in the surface of a glass filled with cold liquid. Moisture condensation on the head drum will cause damage to the tape. In conditions where condensation may occur, keep the recorder turned on for a few hours to let the moisture dry.

ABOUT HEAD CLEANING

Accumulation of dirt and other particles on the video heads may cause the playback picture to become blurred or interrupted. Be sure to contact your nearest JVC dealer if such troubles occur.

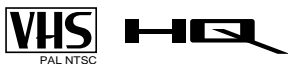

- Only cassettes marked "VHS" can be used with this videorecorder.
- HQ VHS is compatible with existing VHS equipment.

Basic Connections

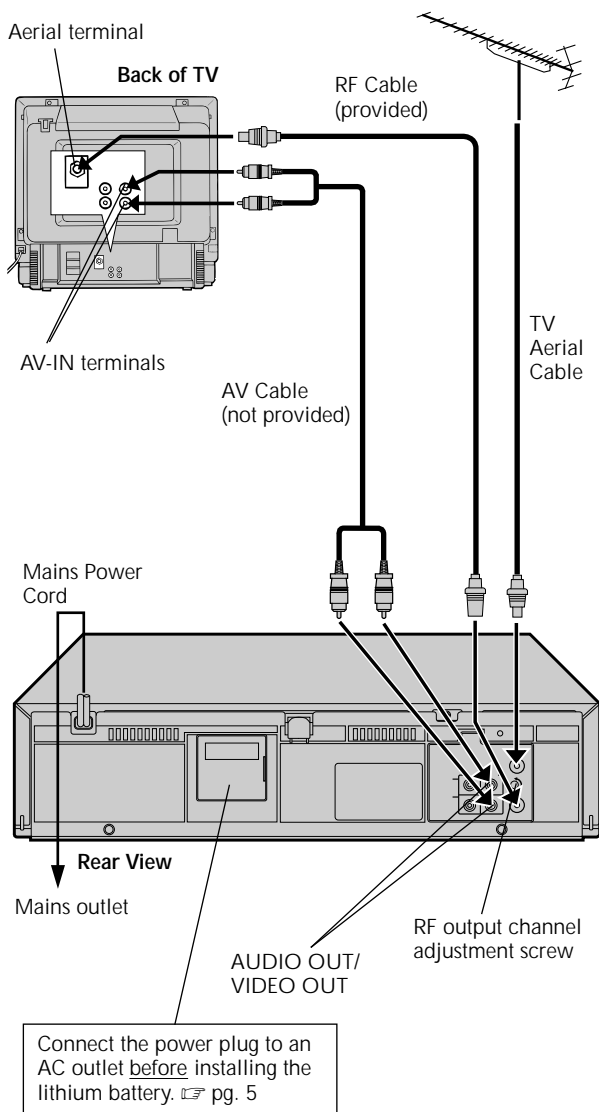

It's essential that your video recorder be properly connected. Follow these steps carefully. THESE STEPS MUST BE COMPLETED BEFORE ANY VIDEO OPERATION CAN BE PERFORMED.

1

CHECK CONTENTS

Make sure the package contains all of the accessories listed in "Specifications" (pg. 34).

2

SITUATE RECORDER

Place the recorder on a stable, horizontal surface.

3

CONNECT RECORDER TO TV

The connection method you use depends on the type of TV you have.

RF CONNECTION

- To Connect To A TV With NO AV Input Terminals . . .
 - a- Disconnect the TV aerial cable from the TV.
 - b- Connect the TV aerial cable to the ANT. IN jack on the rear panel of the recorder.
 - c- Connect the provided RF cable between the RF OUT jack on the rear panel of the recorder and the TV's aerial terminal.

Before operating the recorder, make sure the TV's channel is set to the VIDEO channel (pg. 5).

AV CONNECTION

- To Connect To A TV With AV Input Terminals . . .
 - a- Connect the aerial, recorder and TV as per "RF CONNECTION".
 - b- Connect an optional AV cable between the AUDIO OUT and VIDEO OUT connectors on the rear panel of the recorder and the TV's AV-IN terminals.

Before operating the recorder, make sure the TV is set to the VIDEO (or AV) mode.

4

CONNECT RECORDER TO MAINS

Plug the end of the mains power cord into a mains outlet.

After you plug the mains power cord into a mains outlet, the Auto Set Up display appears on the TV screen and/or on the recorder's front display panel when the button on the recorder/remote control is pressed for the first time to power on the recorder (pg. 4).

Auto Set Up

Auto Channel Set

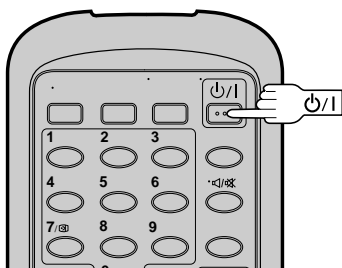
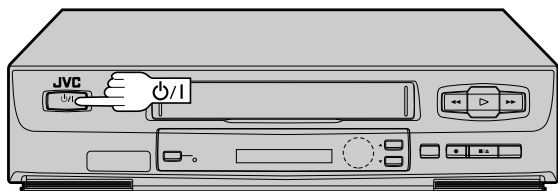

ATTENTION

Once you have performed Auto Set Up, even if the recorder's memory backup has expired, all the stored stations remain in the recorder's memory and the recorder will not perform Auto Set Up again. If you have moved to a different area or a new station starts broadcasting in your area, perform tuner setting. [pg. 24](#)

When the **⏻/1** button on the recorder/remote control is pressed for the first time to power on the recorder after you plug the mains power cord into a mains outlet, the Auto Set Up function sets the tuner channels automatically. You can refer to the front display panel and/or the on-screen display to perform this procedure.

Before starting, make sure of the following:

- The TV aerial cable should be connected to the recorder.
- The recorder's mains power cord should be connected to a mains outlet. [pg. 3](#)
- If you want to use the on-screen display, the TV should be set to its AV mode (with AV connection [pg. 3](#)) or UHF channel 36 (with RF connection [pg. 3](#)).

START AUTO SET UP

1

Press **⏻/1**.

- The Auto Set Up function scans all the channels that are receivable by your recorder. It then automatically assigns each receivable channel to the **TV PROG** buttons. It skips non-receivable channels.
- As Auto Set Up progresses, the "■" mark on the screen moves from left to right.
- After you perform Auto Set Up, if the tuner channels have not been set properly or if "CH --" is displayed on the front display panel, make sure that the aerial cable is connected to the recorder properly and turn off the recorder power once, and turn the power back on to try Auto Set Up again.
- If there is a power cut, or if you press **⏻/1** or **MENU** while Auto Set Up is in progress, Auto Set Up will be interrupted; be sure to turn off the recorder power once and try again.

DO NOT press any button on the recorder or remote control while Auto Set Up is in progress.

On-Screen Display

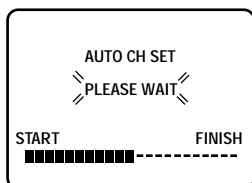

TV Screen

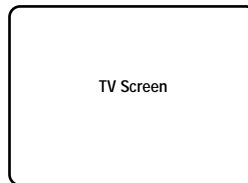

Front Display Panel



When Auto Set Up is completed, the lowest position number will appear on the front display panel.

NOTES:

- If you want to set the tuner manually such as to add or skip channels, to swap channel positions, or to fine-tune channels, [pg. 25](#).
- If no sound accompanies the picture on some channels that have been stored by Auto Set Up, the TV system setting for those channels may be incorrect. Select the appropriate TV system for those channels. ["TV System Selection – When you see the picture but hear no audio" on page 27.](#)

Video Channel Set

Video Channel (RF Output Channel) is the channel on which your TV receives picture and sound signals from the video recorder through the RF cable.

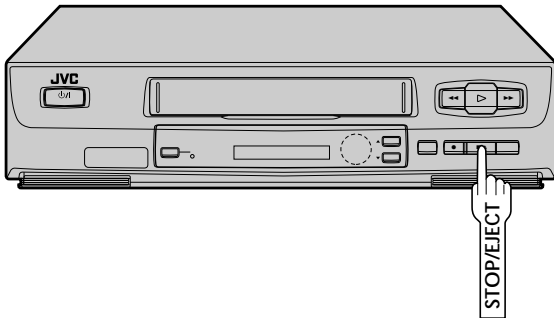

TEST SIGNAL

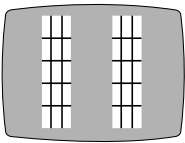

The channel on which the screen to the left appear clearly in step 3 is your Video Channel.

To view picture signals from the video recorder, set your TV to the Video Channel.

The video recorder is designed to send picture and sound signals via the connected RF cable to your TV on UHF channel 36.

After you have turned on the recorder, set your TV to UHF channel 36, fine-tune as necessary, and check if picture and sound being received from the recorder come out clearly or not:

- If clear enough — you don't have to perform the following steps. Go to "Installing/Removing the lithium battery" on this page.
- If not — UHF channel 36 or neighbouring channels may be occupied by local stations. Perform the following steps to change the Video Channel to another channel between 32 – 40.

Before starting, make sure of the following:

- The recorder's power should be off.
- No cassette should be inserted in the recorder.
- The connected TV's power should be on.

SET TV CHANNEL

Set your TV to a channel between 32 and 40 that you want to use as the Video Channel on the TV.

BRING TEST SIGNAL ON SCREEN

Hold down the recorder's STOP/EJECT button for more than 5 seconds.

- "- OUT" appears on the display panel.

TUNE YOUR RECORDER

Turn the RF output channel adjustment screw on the rear panel of the recorder by using a screwdriver until the two vertical bars become as clear as they can be.

EXIT VIDEO CHANNEL SET MODE

Press the recorder's STOP/EJECT button again to finish the setting.

Be sure to connect the power plug to an AC outlet first before installing the lithium battery; otherwise, the battery's service life will be drastically shortened.

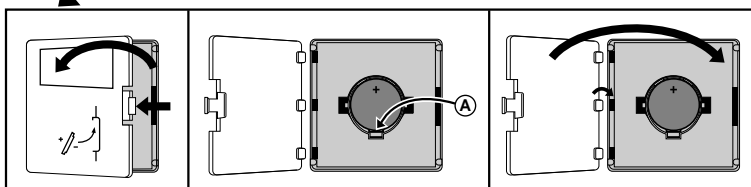
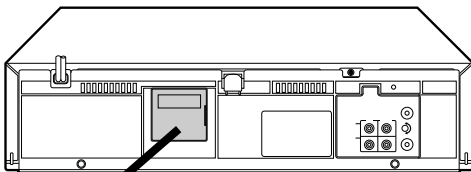

Installing/Removing the lithium battery

- 1 Make sure that the power plug is connected to an AC outlet and turn off the VCR power.
- 2 Open the battery cover while pressing the release tab as illustrated.
- 3 Insert a lithium battery with the plus (+) side up and push it in.
 - To remove the lithium battery, press the latch (A) downward using a pointed non-metallic object, then pull out the lithium battery.
- 4 Close the battery cover until it clicks in place.

Select Language

Turn on the TV and select the VIDEO channel (or AV mode).

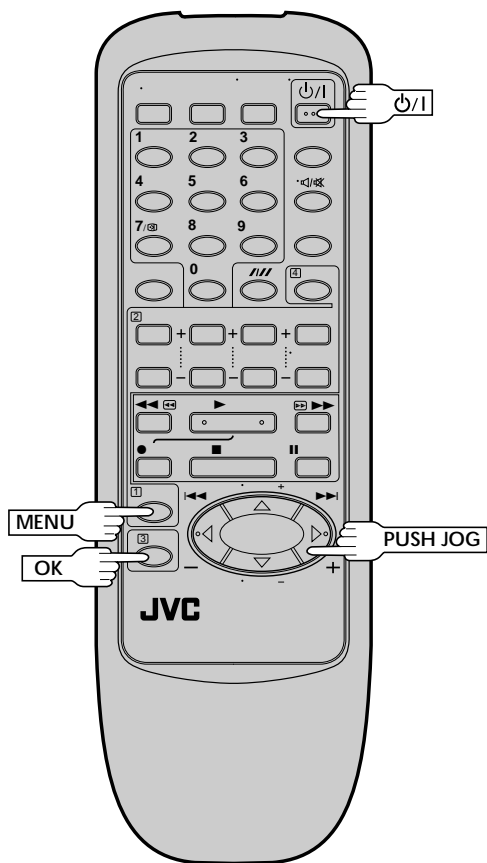

1

TURN ON THE RECORDER

Press **⏻/1**.

2

ACCESS MAIN MENU SCREEN

Press **MENU** twice.

3

ACCESS INITIAL SET SCREEN

Press **PUSH JOG** $\Delta \nabla$ to place the pointer next to "INITIAL SET", then press **OK**.

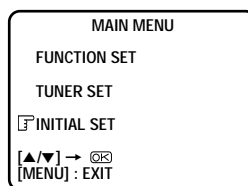

4

ACCESS LANGUAGE SELECT SCREEN

Press **PUSH JOG** $\Delta \nabla$ to place the pointer next to "LANGUAGE SELECT", then press **OK**.

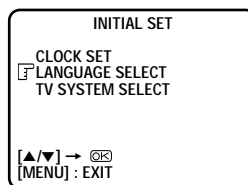

5

SELECT LANGUAGE

Place the pointer next to the language of your choice (English or Russian) by pressing **PUSH JOG** $\Delta \nabla$, then press **OK**.

6

RETURN TO NORMAL SCREEN

Press **MENU**.

Select Television System

Turn on the TV and select the VIDEO channel (or AV mode).

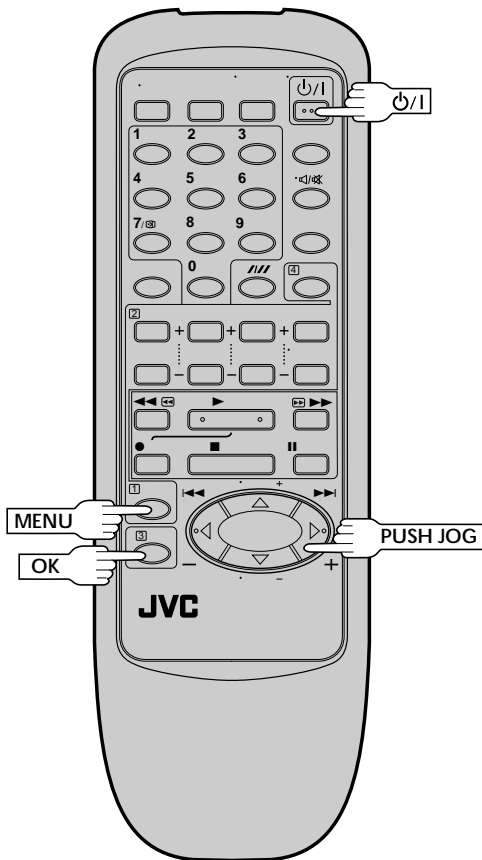

Major Countries	TV System
Kuwait, U.A.E, Indonesia, Singapore, Thailand, Malaysia, Iran, Saudi Arabia, Egypt, Morocco, Lebanon, Iraq	B/G
China, Mongolia, Russia	D/K
Hong Kong	I

1 TURN ON THE RECORDER

Press **Power**.

2 ACCESS MAIN MENU SCREEN

Press **MENU** twice.

3 ACCESS INITIAL SET SCREEN

Press **PUSH JOG** $\Delta \nabla$ to place the pointer next to "INITIAL SET", then press **OK**.

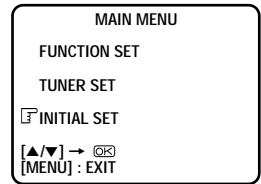

4 ACCESS TV SYSTEM SELECT SCREEN

Press **PUSH JOG** $\Delta \nabla$ to place the pointer next to "TV SYSTEM SELECT", then press **OK**.

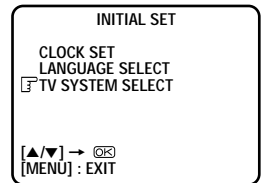

5 SELECT TELEVISION SYSTEM

Place the pointer next to the appropriate TV system that matches the system of TV being used (refer to the table to the left). Then press **OK**.

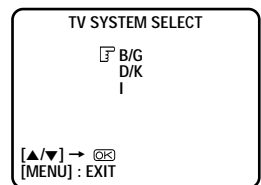

6 RETURN TO NORMAL SCREEN

Press **MENU**.

NOTES:

- If no colours appear on the screen when using a multi-system television with its system select switch set to AUTO, change the TV system setting of the recorder.
- For more information on multi-system compatibility. p. 22

Clock Set

Turn on the TV and select the VIDEO channel (or AV mode).

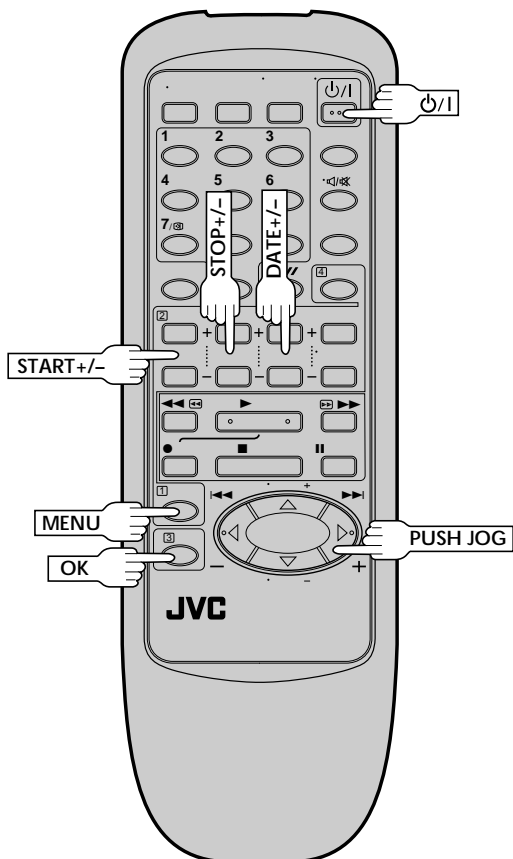

NOTE:

If the year digits are automatically cleared, it is possible that you have input 29th February for a non-leap year. Input the correct data.

1 TURN THE RECORDER ON

Press **⏻/I**.

2 ACCESS MAIN MENU SCREEN

Press **MENU** twice.

3 ACCESS INITIAL SET SCREEN

Press **PUSH JOG** $\Delta \nabla$ to place the pointer next to "INITIAL SET", then press **OK**.

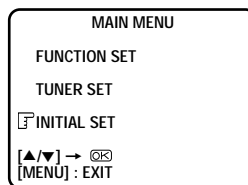

4 ACCESS CLOCK SET SCREEN

Press **PUSH JOG** $\Delta \nabla$ to place the pointer next to "CLOCK SET", then press **OK**. The Clock Set screen appears.

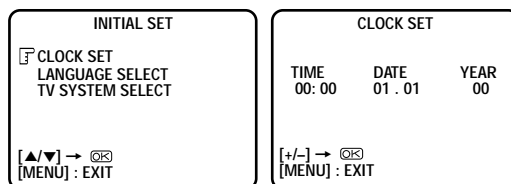

5 SET TIME

Press **START +/-** to set the time.

- Press and hold either button to delay or advance the time by 30 minutes.

6 SET DATE

Press **STOP +/-** to set the date.

- Press and hold either button to change the date by 15 days.

7 SET YEAR

Press **DATE +/-** to set the year.

8 START CLOCK OPERATION

Press **MENU**.

On-Screen Displays

Turn on the TV and select the VIDEO channel (or AV mode).

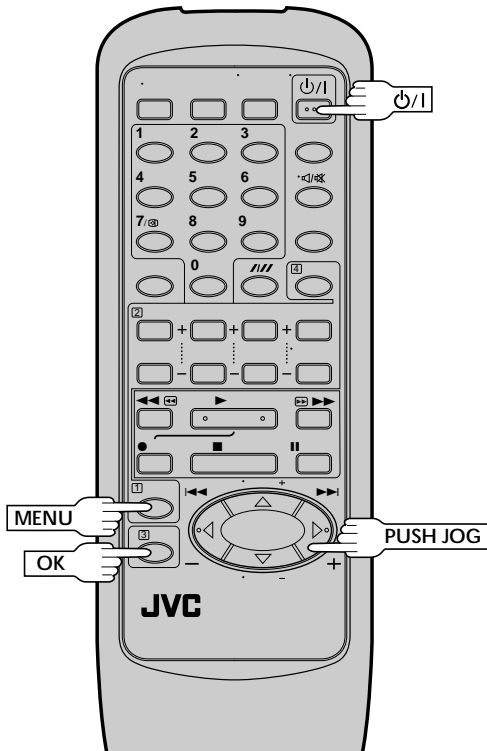

NOTES:

- When you use this recorder as the player for editing, be sure to set "O.S.D." to "OFF" before starting.
- During playback, the operation mode indicators may be disturbed depending on the type of tape being used.

You can choose whether or not to have various operational indicators appear on screen, by setting this function ON or OFF.

1 TURN ON THE RECORDER

Press **ON**.

2 ACCESS MAIN MENU SCREEN

Press **MENU** twice.

3 ACCESS FUNCTION SET SCREEN

Place the pointer next to "FUNCTION SET" by pressing **PUSH JOG** $\Delta \nabla$, then press **OK**.

4 ACCESS O.S.D. SCREEN

Place the pointer next to "O.S.D." by pressing **PUSH JOG** $\Delta \nabla$, then press **OK**.

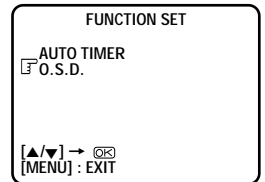

5 ENABLE/DISABLE ON-SCREEN DISPLAY

The default setting is "ON", so if you want on-screen displays, leave the setting as it is and go to step 6. If you don't want the displays to appear, press **PUSH JOG** $\Delta \nabla$ to place the pointer next to "OFF", then press **OK**.

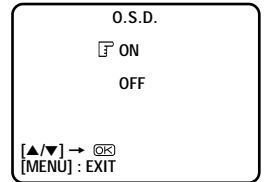

6 RETURN TO NORMAL

Press **MENU**.

The superimposed indication on the TV screen tells you what the recorder is doing.

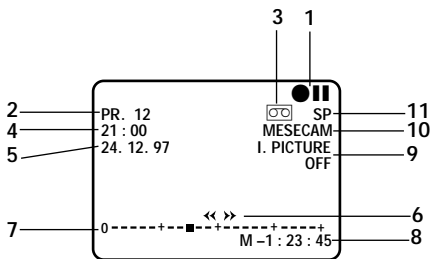

- 1- Operation mode indicators
- 2- Channel position number/Aux. indicator (AUX)
- 3- Cassette loaded mark
- 4- Clock display
- 5- Current day/month/year
- 6- Tape direction
- 7- Tape position indicator (☞ pg. 13)
- 8- Counter display (including Counter Memory indicator)
- 9- Intelligent picture indicator (☞ pg. 12)
- 10- Colour system indicator (☞ pg. 22)
- 11- Tape speed SP/LP/EP

Basic Playback

Turn on the TV and select the VIDEO channel (or AV mode).

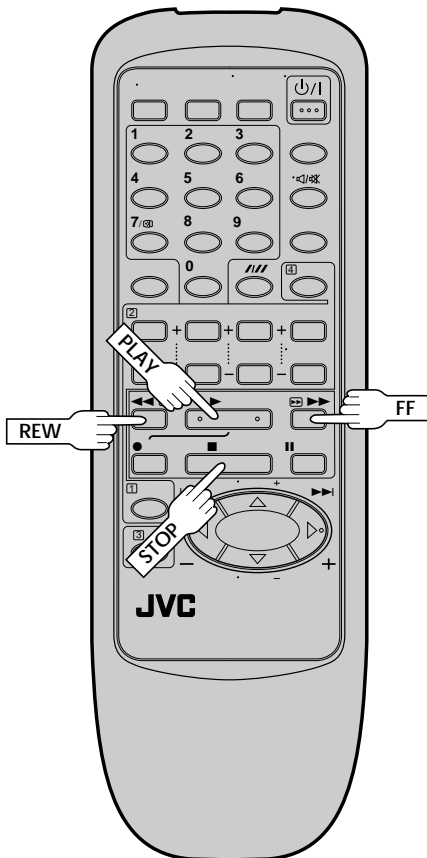
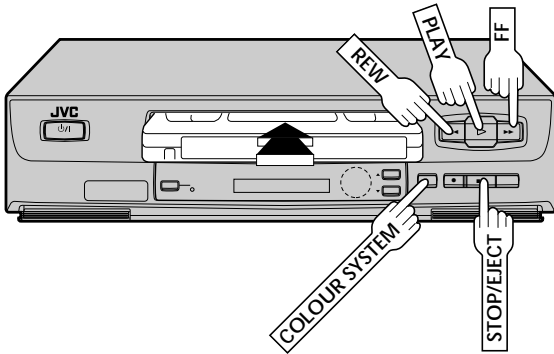

The easiest, most basic operation possible with your video recorder is tape playback. Already-recorded signals on a video tape are read by your video recorder and displayed on your TV just like a TV programme.

1

LOAD A CASSETTE

Make sure the window side is up, the rear label side is facing you and the arrow on the front of the cassette is point toward the recorder. Don't apply too much pressure when inserting.

- The recorder power comes on automatically and the counter is reset to 0:00:00.
- Select the appropriate colour system by pressing the **COLOUR SYSTEM** button. (pg. 22)
- If the record safety tab has been removed, playback begins automatically.

2

FIND PROGRAMME START POINT

If the tape is advanced past the start point, press **REW**. To go forward, press **FF**.

3

START PLAYBACK

Press **PLAY**.

4

STOP PLAYBACK

Press **STOP** on the remote or **STOP/EJECT** on the recorder's front panel. Then press **STOP/EJECT** to remove the cassette.

Usable cassettes

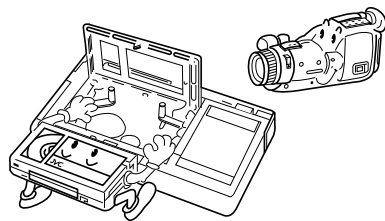

- Compact VHS camcorder recordings can be played on this video recorder. Simply place the recorded cassette into a VHS Cassette Adapter and it can be used just like any full-sized VHS cassette.
- This video recorder can record on regular VHS and Super VHS cassettes. However, it will record and play back regular VHS signals only. It is not possible to play back a recorded Super VHS tape.

Playback Features

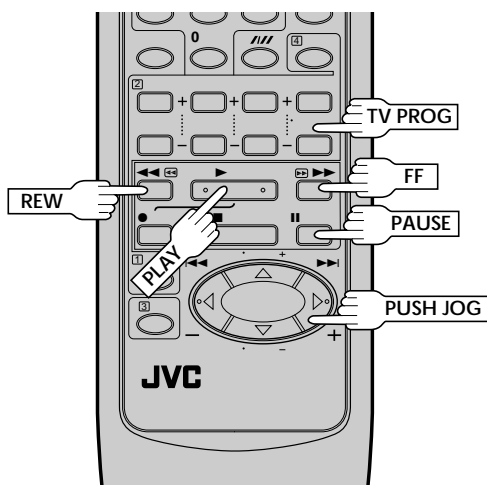
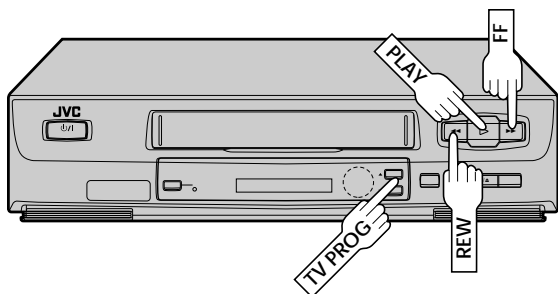

Take advantage of special functions possible with the recorder's controls or the remote control.

High-Speed Search

1 ACTIVATE HIGH-SPEED SEARCH

During playback or still, press **FF** for forward high-speed search, or **REW** for reverse high-speed search.

To resume normal playback, press **PLAY**.

Still Picture/Frame-By-Frame Playback

1 PAUSE DURING PLAYBACK

Press **PAUSE**. If there is vertical jitter, use the **TV PROG** buttons to correct the picture.

2 ACTIVATE FRAME-BY-FRAME PLAYBACK

Press **PAUSE**.

OR

Press **PUSH JOG** ◀ or ▶.

To resume normal playback, press **PLAY**.

Slow Motion

1 ACTIVATE SLOW-MOTION PLAYBACK

During still picture, press and hold **PAUSE** for 2 seconds, then release. Press and release again to return to still picture.

OR

During still picture, press and hold **PUSH JOG** ◀ or ▶. Release to return to still picture.

To resume normal playback, press **PLAY**.

Variable-Speed Search

1 ACTIVATE VARIABLE-SPEED SEARCH

During playback, press **PUSH JOG** ◀ or ▶.

- The more times you press, the faster the playback picture moves.
- To decrease speed, press the button for the opposite direction.

To resume normal playback, press **PLAY**.

NOTES:

- For short searches, press and hold **FF** or **REW** for over 2 seconds. When released, normal playback resumes.
- In the search, still, or frame by frame playback mode, the picture may be distorted, and there may be a loss of colour; with SP recordings, noise may also appear in the picture.

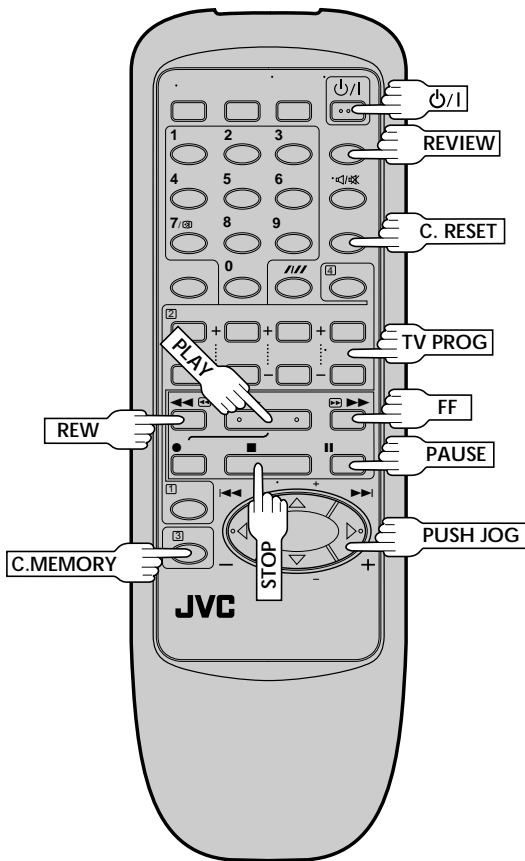

Manual Tracking

Your video recorder is equipped with automatic tracking control. During playback, you can override this and adjust the tracking manually by pressing the **TV PROG** buttons.

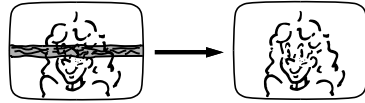

1 OVERRIDE AUTOMATIC TRACKING

Press the recorder's **TV PROG** ▲ and ▼ buttons simultaneously to engage manual tracking.

2 ADJUST TRACKING MANUALLY

Press **TV PROG** ▲ or ▼ to adjust tracking.

3 RETURN TO AUTOMATIC TRACKING

Press the recorder's **TV PROG** ▲ and ▼ buttons simultaneously to re-engage automatic tracking.

NOTE:

When a new tape is inserted, the recorder enters the automatic tracking mode automatically.

Intelligent Picture

To get a better picture when viewing tapes with noise such as rental tapes. Useful for normal playback of SP mode recorded tapes as well.

1 ACTIVATE INTELLIGENT PICTURE

During playback or stop, press **INTELLIGENT PICTURE**.

- Pressing the **INTELLIGENT PICTURE** button once displays the current setting on the screen for about 5 seconds; press the button again to change the setting (ON/OFF).
- Intelligent Picture is not effective during search, slow, still, or frame-by-frame playback.

Repeat Playback

Your video recorder can automatically play back the whole tape 20 times repeatedly.



1 START PLAYBACK

Press **PLAY**.

2 ACTIVATE REPEAT PLAYBACK

Press **PLAY** and hold for over 5 seconds, then release.

- The Play indicator (▷) on the display panel blinks slowly.
- The tape plays 20 times automatically, and then stops.

3 STOP PLAYBACK

Press **STOP** at any time to stop playback.

NOTE:

Pressing **PLAY**, **REW**, **FF** or **PAUSE** also stops Repeat Playback.

Index Search

Your recorder automatically marks index codes at the beginning of each recording. This function gives you quick access to any one of 9 index codes in either direction.

NOTE:

Before starting, make sure the recorder is in the Stop mode.

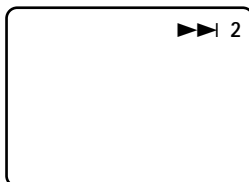

1 ACTIVATE INDEX SEARCH

Press **PUSH JOG** < or > (◀◀ or ▶▶) on the remote control. "◀◀ 1" or "▶▶ 1" is displayed on screen and search begins in the corresponding direction.

- To access index codes 2 through 9, press **PUSH JOG** < or > repeatedly until the correct index number is displayed.

Ex.: To locate the beginning of B from the current position, press **PUSH JOG** < twice.
To locate the beginning of D from the current position, press **PUSH JOG** > once.

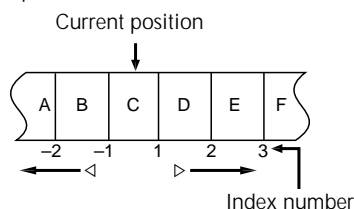

- When the specified index code is located, playback begins automatically.

Next Function Memory

You can set your recorder's power to go off automatically after the tape is fully rewound. Before starting, make sure the recorder is in the Stop mode.
For Automatic Power Off After Tape Rewind . . .
. . . press **REW**, then press ⏻ within 2 seconds.

NOTE:

If you want the power to be turned off automatically when the counter reads "0:00:00" (instead of at the beginning of the tape), press **C. MEMORY** so that the "M" mark appears before pressing **REW**.

Counter Memory

Returns to the counter reading of "0:00:00" to conveniently find a specific place on the tape automatically.

1 SET COUNTER MEMORY

Press **C. RESET** during playback at a point you wish to locate later. The counter reads "0:00:00". Then press **C. MEMORY**, and "M" appears in front of the counter digits.

2 ACTIVATE COUNTER MEMORY

When you wish to return to the designated point, press **STOP** and then **REW** or **FF**.

- The tape rewinds or fast-forwards and stops at about 0:00:00 automatically.
- To cancel Counter Memory, press **C. MEMORY** again.

Instant ReView

Simply by pressing a single button, the recorder power comes on, rewinds, and begins playback of the last timer-recorded programme. If you have several programmes recorded, you can easily access any of them.

NOTE:

Before starting, make sure that the recorder is off and that the Timer mode is disengaged.

1 ACTIVATE INSTANT REVIEW

Press **REVIEW**. The recorder power comes on and the recorder searches for the index code indicating the start of the last timer-recorded programme. Once it's found, playback begins automatically.

The front display panel tells you how many programmes have been recorded. If you have, for example, 3 programmes, "REVIEW" and "3" appear and blink. To watch the first of the 3 programmes, press **REVIEW** three times. The recorder searches and begins playback automatically. You can access a programme as far as 9 index codes away from the current tape position.

NOTE:

Instant ReView is not possible while the recorder is in the Timer mode.

Tape Position Indicator

The tape position indicator appears on screen when, from the Stop mode, you press **FF**, **REW** or perform an Index Search. The position of "■" in relation to "0" (beginning) or "+" (end) shows you where you are on the tape.
"O.S.D." (ⓘ pg. 9) must be set to "ON", or the indicator will not appear.

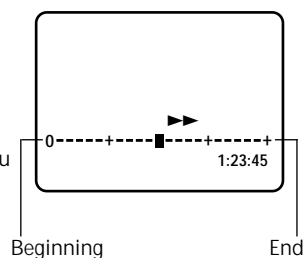

NOTE:

Depending on the type of tape used, there may be times when the indication is not correct.

Basic Recording

Turn on the TV and select the VIDEO channel (or AV mode).

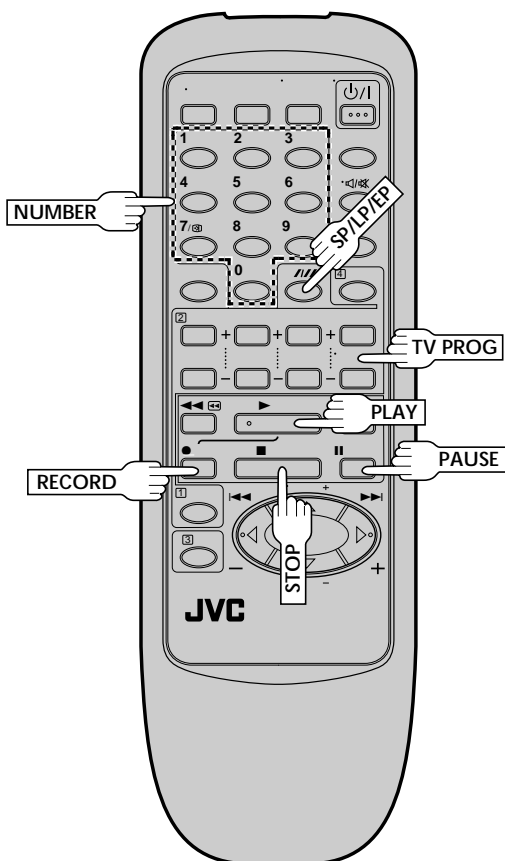
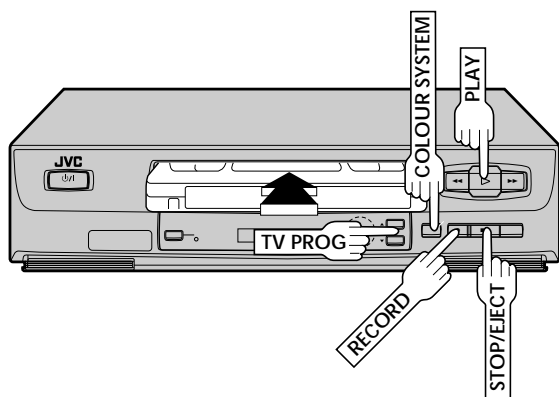

TV signals being received by the recorder's built-in tuner can be recorded onto a video tape. You can "capture" a TV programme using your video recorder.

1 LOAD A CASSETTE

Insert a cassette with the record safety tab intact.

- The counter is reset to 0:00:00 and the recorder power comes on automatically.
- Select the appropriate colour system by pressing the **COLOUR SYSTEM** button. (☞ pg. 22)

2 CHOOSE A PROGRAMME

Press **TV PROG +/-** or the **NUMBER** keys to select the channel you wish to record.

3 SET TAPE SPEED

Press **/// (SP/LP/EP)**. Check the SP/LP/EP indicator on the recorder display panel to confirm the selected tape speed.

4 START RECORDING

Press and hold **RECORD** and **PLAY** on the remote control, or press **RECORD** on the recorder.

5 PAUSE/RESUME RECORDING

Press **PAUSE**. Press **PLAY** to resume recording.

6 STOP RECORDING

Press **STOP** on the remote control or **STOP/EJECT** on the recorder. Then press **STOP/EJECT** to remove the cassette.

Recording Resume Function

If there is a power outage during recording (or Instant Timer Recording or timer recording), the recording will resume automatically when power is restored to the recorder unless the recorder's memory backup has expired.

Accidental erasure prevention

- To prevent accidental recording on a recorded cassette, remove its safety tab. To record it later, cover the hole with adhesive tape.

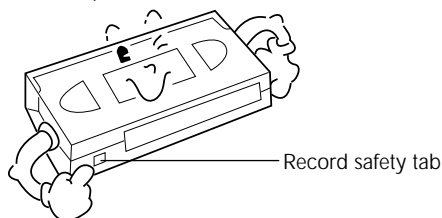

Recording Features

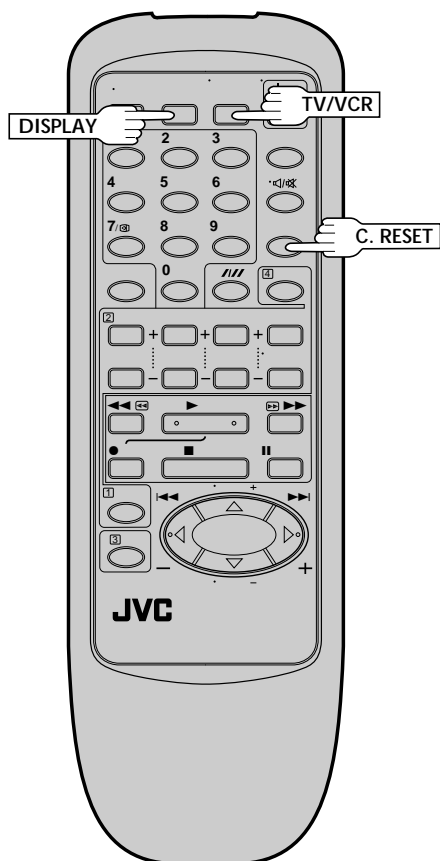
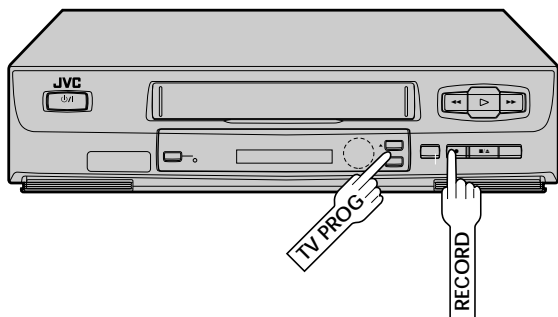

Record One Programme While Watching Another

1 SELECT CHANNEL TO WATCH

Once recording is in progress, all you need to do is to set the channel controls on the TV for the station you wish to view.

- The programme selected with the TV's channel controls appears on the TV screen while the one selected with the recorder's **TV PROG** buttons is recorded on the tape.

Elapsed Recording Time Indication

You can check the exact time of a recording.

1 SET COUNTER DISPLAY

Press **DISPLAY** until a counter reading appears on the display panel.

- By pressing the **DISPLAY** button, you can change the display to show the counter reading, channel position* or clock time.
* channel position is not displayed during playback.

2 RESET COUNTER

Press **C. RESET** before starting recording or playback.

- The counter is reset to "0:00:00" and shows the exact elapsed time as the tape runs.

Instant Timer Recording (ITR)

This easy method lets you record for from 30 minutes to 6 hours (selectable in 30-min. increments), and shuts the recorder off after recording is finished.

1 START RECORDING

Press **RECORD** on the recorder.

2 ENGAGE ITR MODE

Press **RECORD** again. "O" blinks and 0:30 appears on the front display panel.

3 SET RECORDING DURATION

If you want to record for more than 30 minutes, press **RECORD** to extend the time. Each press extends recording time by 30 minutes.

NOTE:

You can only perform ITR using the **RECORD** button on the recorder's front panel.

Timer Programming

Remember, the clock must be set before you can programme the timer (☞ pg. 8).

Before performing the following steps:

- Insert a cassette with the safety tab in place. The recorder will come on automatically.
- Turn on the TV and select the VIDEO channel (or AV mode).
- Select the appropriate colour system by pressing the **COLOUR SYSTEM** button. (☞ pg. 22)

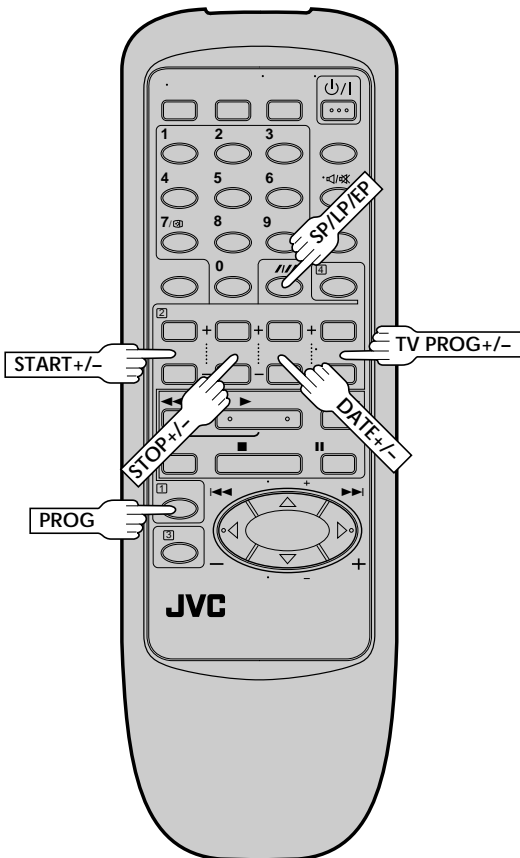
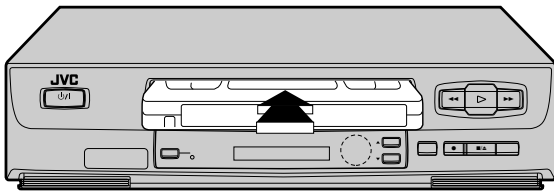

1

ACCESS TIMER PROGRAMMING SCREEN

Press **PROG.**

2

ACCESS PROGRAMME SCREEN

Press **START +/-**. (If you're just starting out, "P1" appears.)

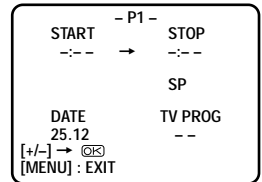

3

ENTER PROGRAMME START TIME

Press **START +/-** to enter the time you want recording to start.

- Press and hold **START +/-** to move in 30-minute increments, or press and release repeatedly to move 1 minute at a time.

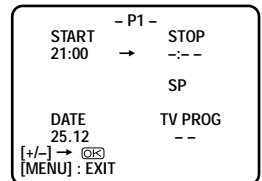

4

ENTER PROGRAMME STOP TIME

Press **STOP +/-** to enter the time you want recording to stop.

5

ENTER PROGRAMME DATE

Press **DATE +/-**. (The current date appears on screen. The date you enter appears in its place.)

6

ENTER CHANNEL POSITION

Press **TV PROG +/-**.

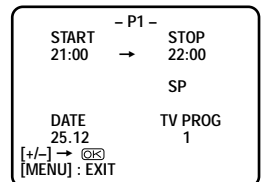

7

SET TAPE SPEED

Press **///** (SP/LP/EP) to set the tape speed.

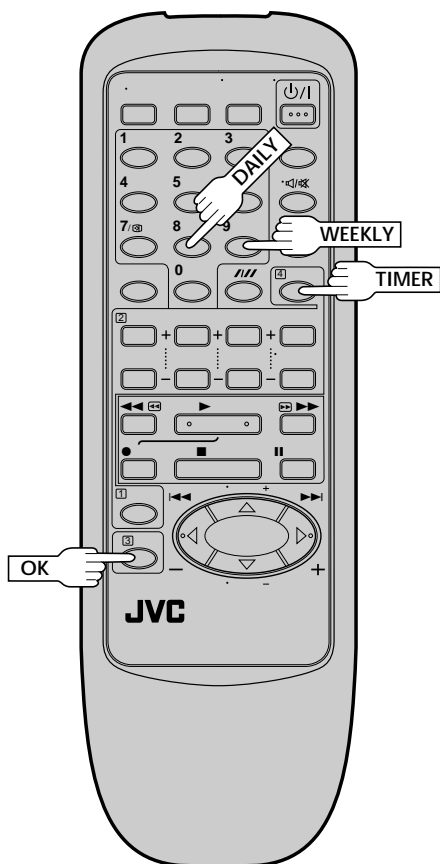

8 RETURN TO NORMAL SCREEN

After confirming all information is correct, press **OK** and the normal screen appears.

- Repeat steps 1-8 for each additional programme.

9 ENGAGE RECORDER'S TIMER MODE

Press **TIMER**. The recorder turns off automatically.

9

To Timer-Record Weekly Or Daily Serials . . .
 . . . anytime during steps 2 through 8, press **WEEKLY** (NUMBER key "9") for weekly serials or **DAILY** (NUMBER key "8") for daily serials (Monday-Friday). Either "WEEKLY" or "DAILY" appears on the screen. Pressing the button again makes the corresponding indication disappear.

NOTE:

You can programme this recorder to timer-record as many as 8 programmes. If you try to programme the recorder to record a ninth, "PROGRAM FULL" appears on screen. To record the extra programme, you must first cancel any unnecessary programmes (see pg. 19).

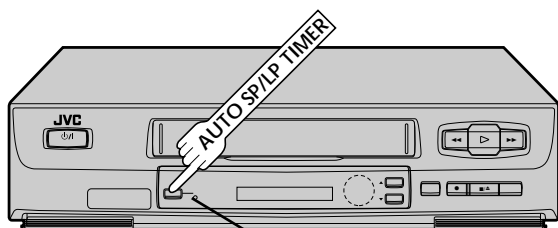

AUTO SP/LP TIMER Indicator

Auto SP/LP Timer

If, when recording in SP mode, there is not enough tape to record the entire programme, the recorder automatically switches to LP mode (with PAL broadcasts) or EP mode (with NTSC broadcasts) to allow complete recording.

1

ENGAGE AUTO SP/LP TIMER

Press **AUTO SP/LP TIMER** on the recorder front panel. The AUTO SP/LP TIMER indicator lights up.

For Example . . .

Recording a PAL-broadcast program of 210 minutes in length onto a 180-minute tape

Approximately 150 minutes	Approximately 60 minutes
SP mode	LP mode
Total 210 minutes	

After the recorder's Timer mode is engaged, make sure the AUTO TIMER SP/LP indicator is still lit; if not, press **AUTO TIMER SP/LP** so that the indicator lights.

NOTES:

- The Auto SP/LP Timer feature is not available during ITR (Instant Timer Recording), and the feature will not work properly with any tapes longer than E-180 as well as some tapes of shorter lengths.
- Even if, in step 1, you press **AUTO SP/LP TIMER** and the **AUTO SP/LP TIMER** indicator lights up, that doesn't mean that the recorder will automatically change from SP to LP (or EP) mode during the course of the recording. Watch the tape later to confirm.
- If you have programmed the recorder to timer-record 2 or more programs, the second programme and those thereafter may not fit on the tape if you engage the Auto SP/LP Timer mode. In this case, make sure the mode is not engaged, then set the tape speed manually during timer programming.
- There may be some noise at the point on the tape where the recorder switches from SP to LP (or EP) mode.

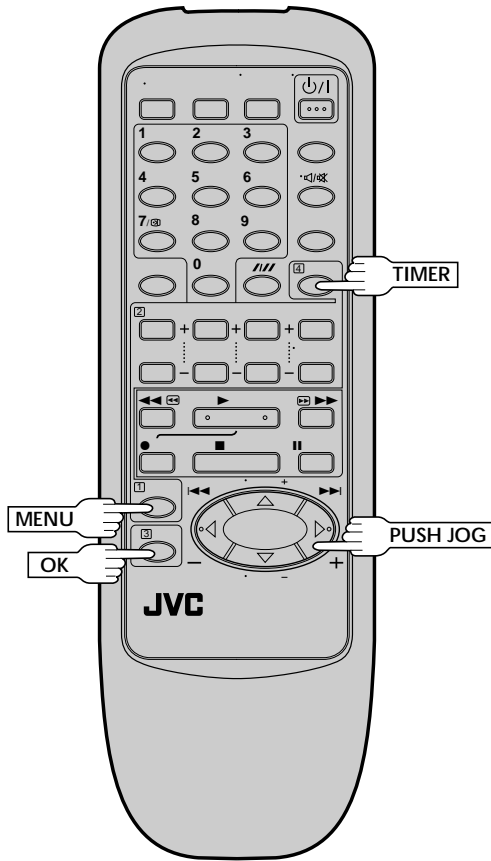

Auto Timer

When the Auto Timer is set to "ON" the timer is automatically engaged when the recorder power is turned off and automatically disengaged when the recorder is powered back on.

1 ACCESS MAIN MENU SCREEN

Press **MENU** twice.

2 ACCESS FUNCTION SET SCREEN

Press **PUSH JOG** $\Delta \nabla$ to place the pointer next to "FUNCTION SET", then press **OK**.

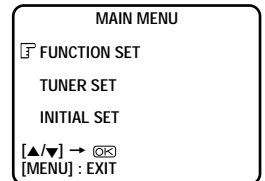

3 ACCESS AUTO TIMER SCREEN

Press **PUSH JOG** $\Delta \nabla$ to place the pointer next to "AUTO TIMER", then press **OK**.

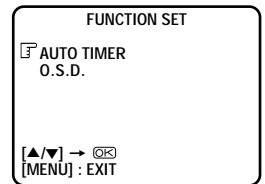

4 SELECT MODE

Press **PUSH JOG** $\Delta \nabla$ to select either "ON" or "OFF".

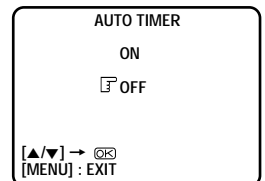

5 RETURN TO NORMAL SCREEN

Press **MENU**.

NOTE:

For safety, when Auto timer is set to "OFF", all other recorder functions are disabled while the Timer mode is engaged. To disengage the timer, press **TIMER**.

Check And Cancel Programmes

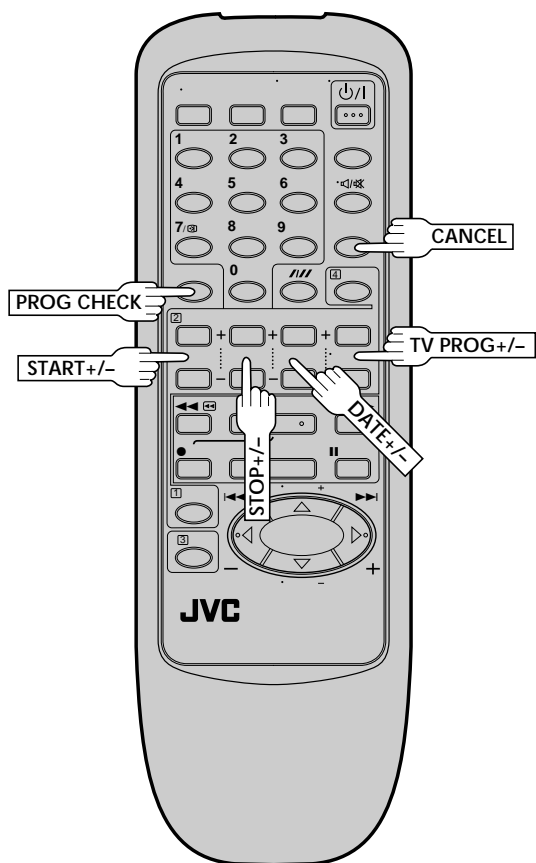

1 ACCESS PROGRAMME SCREEN

Press **PROG CHECK**.

- If the recorder is turned on and the TV is set to its VIDEO channel or AV mode, you can check program information on screen.
- Each time you press **PROG CHECK**, the next programme's information appears.

If All Information Is Correct . . .

. . . programming is completed.

If You Wish To Revise Data . . .

. . . with the recorder's power turned on, go to step 2.

If You Wish To Cancel A Program . . .

. . . with the recorder's power turned on, press **CANCEL**.

All information you input is deleted.

2 REVISE PROGRAMME INFORMATION

Input the appropriate data using the **START +/-**, **STOP +/-**, **DATE +/-** and **TV PROG +/-** buttons on the remote control.

Edit To Or From Another Video Recorder

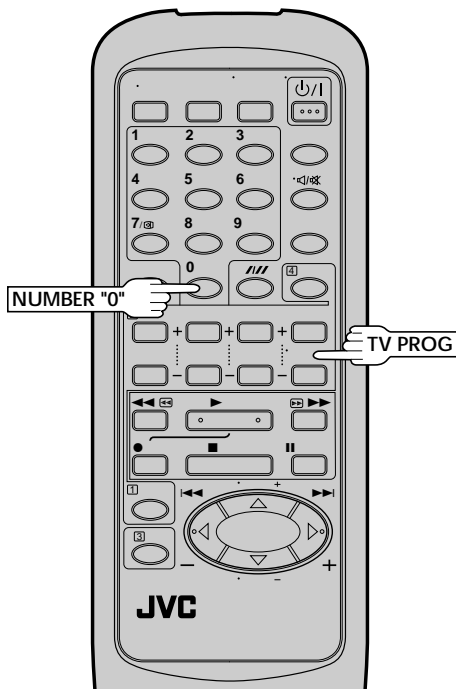

You can use your video recorder as the source player or the recording deck.

1 MAKE CONNECTIONS

Connect the player's AUDIO/VIDEO OUT connector to the recorder's AUDIO/VIDEO IN connector.

2 SET RECORDING DECK'S INPUT MODE

Set to AUX. With this video recorder, press **NUMBER Key "0"** or **TV PROG**. "AU" will appear instead of a channel number.

3 START SOURCE PLAYER

Engage its Play mode.

4 START RECORDING DECK

Engage its Record mode.

NOTES:

- All necessary cables can be obtained from your dealer.
- NTSC tapes being played back in the NTSC → PAL mode (p. 23) cannot be dubbed to another recorder.
- When you dub an NTSC tape using your recorder as the playback deck, select NTSC 3.58 (or NTSC 4.43) with the **COLOUR SYSTEM** button. (p. 22)

IMPORTANT:

- To edit, both the player and the recorder must be of the same colour system. Press your recorder's **COLOUR SYSTEM** button to select the appropriate colour system.
- For more information on multi-system compatibility, pg. 22.

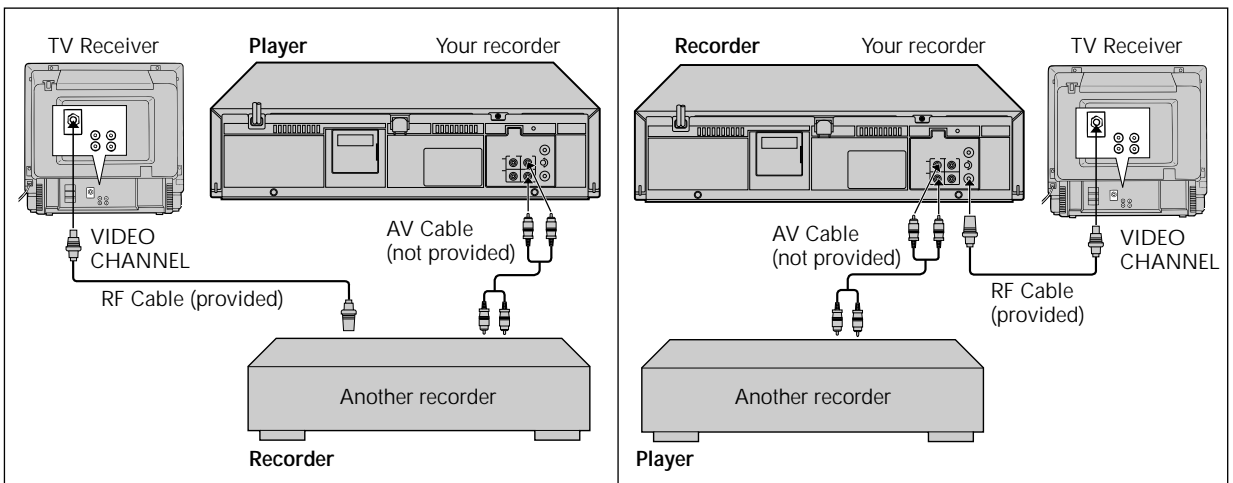

Edit From A Camcorder

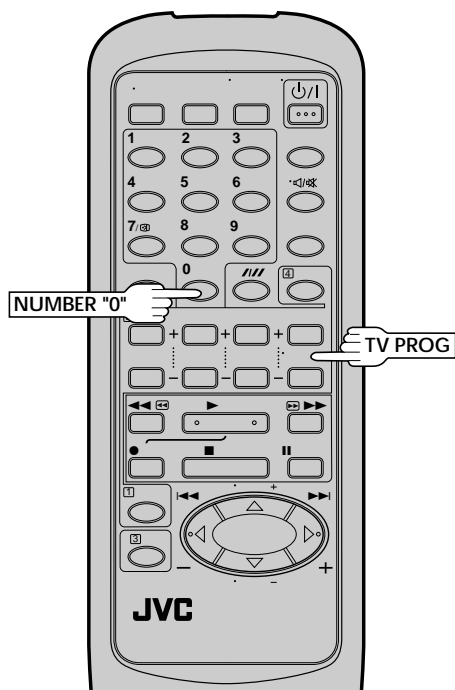

You can use a camcorder as the source player and your video recorder as the recorder.

1 MAKE CONNECTIONS

Connect the camcorder's AUDIO/VIDEO OUT connectors to the recorder's AUDIO/VIDEO input connectors.

2 SET RECORDER'S INPUT MODE

Press **NUMBER** key "0" and/or **TV PROG** so that "AU" appears on the display panel.

3 START CAMCORDER

Engage its Play mode.

4 START RECORDER

Engage its Record mode.

IMPORTANT:

- To edit, both the player and the recorder must be of the same colour system. Press your recorder's **COLOUR SYSTEM** button to select the appropriate colour system.
- PAL and SECAM camcorders can be used as a player for editing.
- For more information on multi-system compatibility, pg. 22.

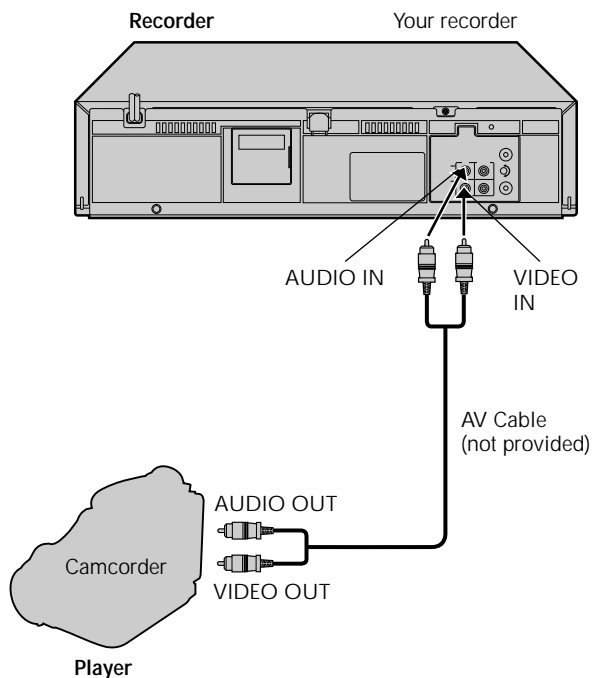

Setting Of The Colour System Select Buttons

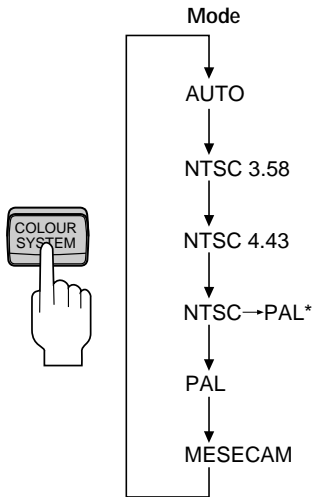

Use the **COLOUR SYSTEM** button on the recorder's front panel to select the colour system. Pressing this button changes the mode as illustrated on the left. The On-Screen display will show which mode is selected.

Mode Display	Description
AUTO (Colour Signal)	Usually set to this mode. This mode automatically detects PAL, NTSC, SECAM or MESECAM and adjusts to the colour system being recorded or played back. When it does not perform properly, set the colour system manually.
MANUAL (Colour Signal)	For recording, there is a choice of 4 selectable modes; PAL/MESECAM/NTSC 3.58/NTSC4.43. Select the mode that matches the colour signal being received. For playback, there is an additional mode which allows NTSC tapes to be played back and viewed on PAL TVs.

* "NTSC → PAL" appears during playback only.

NOTES:

- In the **AUTO** mode, NTSC signals will be automatically recorded as NTSC 3.58.
- In the **AUTO** mode, NTSC tapes will be played back as NTSC 3.58.
- SECAM signals will always be recorded as MESECAM. Select the **AUTO** or the **MESECAM** mode when recording SECAM signals.
- When playing back a SECAM tape, select the **AUTO** or the **MESECAM** mode. The playback picture will always be monochrome.
- In the **NTSC4.43** mode, with some TVs, on-screen displays (Program screen etc.) may roll up or down and there may be a loss of colour. When this happens, select the **AUTO** mode.

Off-Air Recording

The built-in multi-system tuner is capable of receiving PAL B/G, I, D/K, and SECAM B/G and D/K broadcasts.

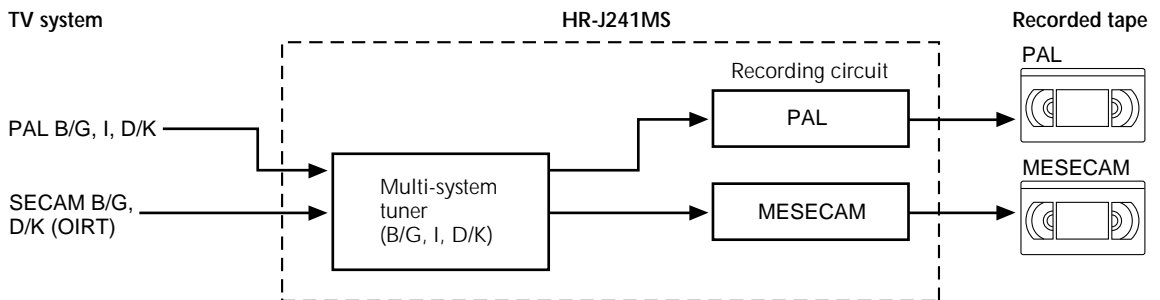

NOTE:

This model does not operate in BRAZIL (PAL-M) or ARGENTINA (PAL-N).

Playback

This recorder can play back all 3 types of recorded tape.

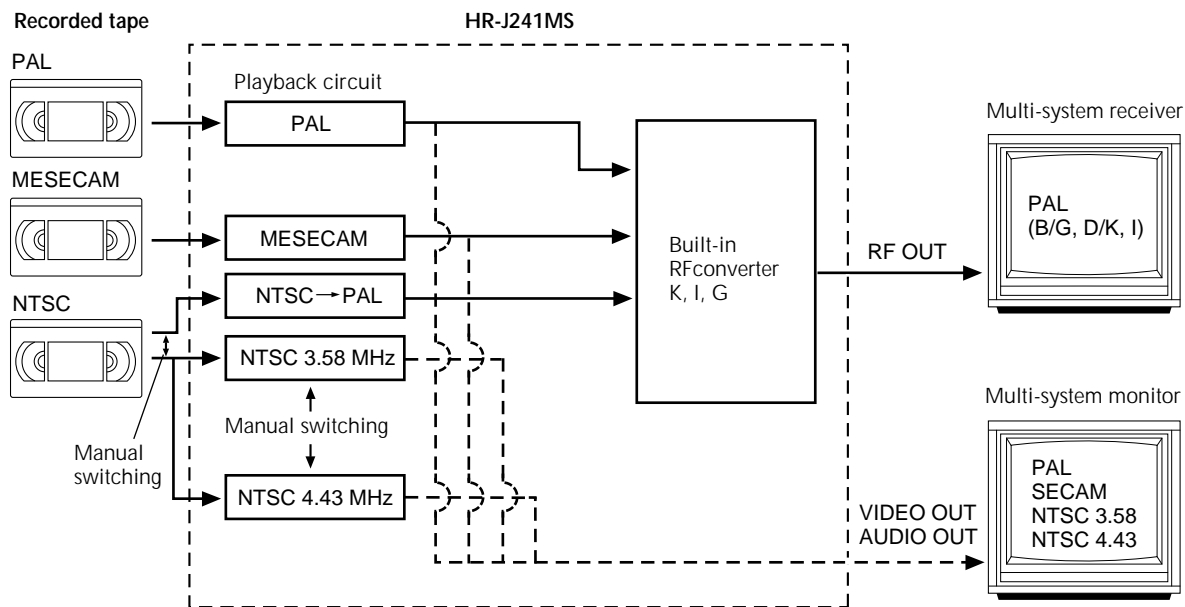

NOTES:

When viewing NTSC tapes on a PAL TV set:

- The picture may shrink vertically with black bars appearing at the top and bottom of the screen. This is not a malfunction on the part of the video recorder nor the TV.
- The picture may roll up or down. This can be corrected using the V-HOLD control found on some TVs. (This cannot be corrected if the TV does not have a V-HOLD control.)
- During search, still, or frame-by-frame playback, the picture will be distorted, and there may be a loss of colour.

ATTENTION:

When this recorder is connected to a multi-system TV, the audio signal may not be heard or may be noisy if the colour system select switch of the TV is adjusted to the AUTO position. In such a case, set the TV's colour system select switch to the appropriate position which corresponds to the TV system you have selected at the TV System Select screen.

Tape-To-Tape Editing

There are 4 different types of recorded tape, depending on the signal recorded.

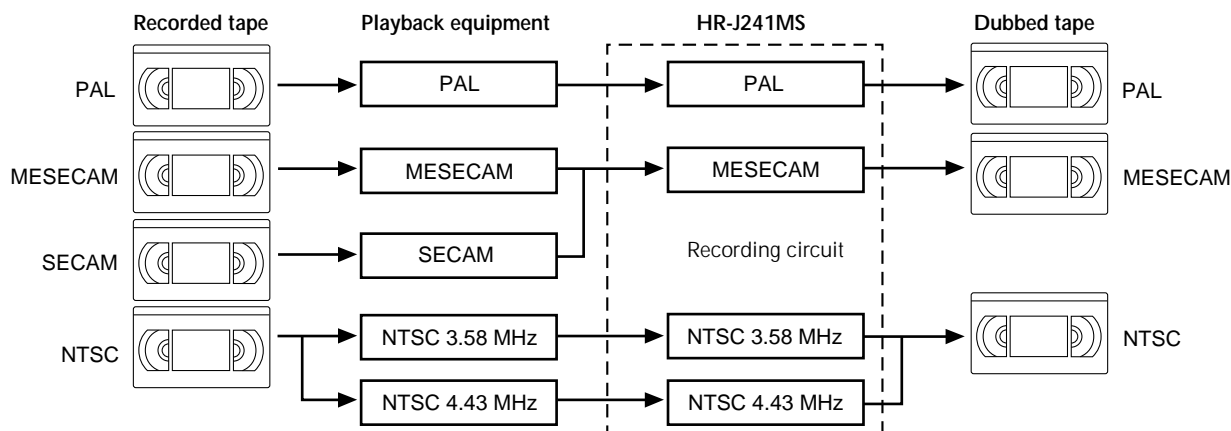

Turn on the TV and select the VIDEO channel (or AV mode).

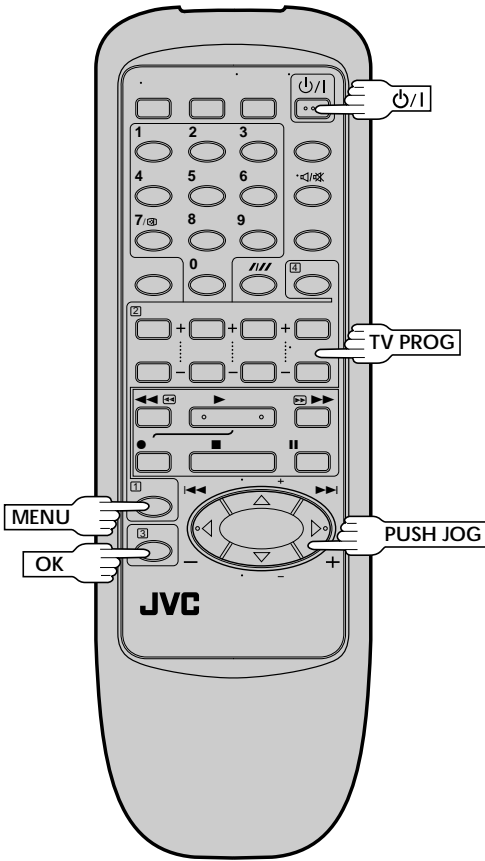

IMPORTANT

Perform the following steps only if auto channel set has not been set correctly by Auto Set Up function (pg. 4) or if you have moved to a different area or if a new station starts broadcasting in your area.

Your recorder needs to memorise all necessary stations in channel positions in order to record TV programmes. Auto Channel Set automatically assigns all receivable stations in your area so that you can call them up with the TV PROG buttons without going through any vacant channels.

Auto Channel Set

- 1** **TURN ON THE RECORDER**
Press **⏻/I**.
- 2** **ACCESS MAIN MENU SCREEN**
Press **MENU** twice.

3

ACCESS TUNER SET SCREEN

Press **PUSH JOG** $\Delta \nabla$ to place the pointer next to "TUNER SET", then press **OK**.

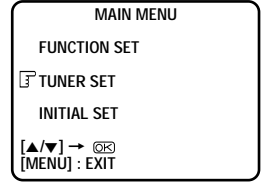

4

SELECT AUTO CH SET MODE

Press **PUSH JOG** $\Delta \nabla$ to place the pointer next to "AUTO CH SET", then press **OK**.

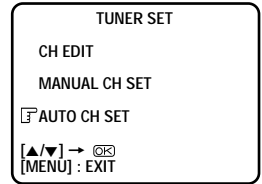

5

SELECT TV SYSTEM

Press **PUSH JOG** $\Delta \nabla$ to place the pointer next to the appropriate TV system, then press **OK**.

- Auto Channel Set will start.

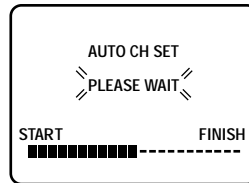
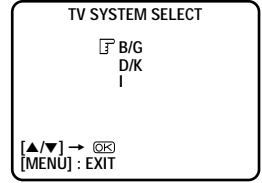

CH	FRQ	SYS	CH	FRQ	SYS
01	150	BG	07	229	BG
02	165	BG	08	237	BG
03	195	BG	09	355	BG
04	205	BG	10	365	BG
05	213	BG	11	374	BG
06	221	BG	12	384	BG

[Δ / ∇] : [] : DELETE
 [Δ / ∇] : [] : EDIT
 [MENU] : EXIT

6

RETURN TO NORMAL SCREEN

Press **MENU**.

IMPORTANT

Since your video recorder memorizes all detected stations even if the reception condition is poor, some of those stored stations may produce a noisy picture. To delete those stations, see "Delete A Channel" on page 26.

Manual Channel Set

Store channels that were not stored during Auto Set Up (pg. 4) or Auto Channel Set (pg. 24).

1 ACCESS TUNER SET SCREEN

Perform steps 1 – 3 of "Auto Channel Set" on page 26.

2 ACCESS MANUAL CH SET SCREEN

Press **PUSH JOG** $\Delta\nabla$ to place the pointer next to "MANUAL CH SET", then press **OK**.

3 SELECT BAND

Press **PUSH JOG** $\Delta\nabla$ to place the pointer next to the band of your choice, then press **OK** to initiate Manual Channel Set.

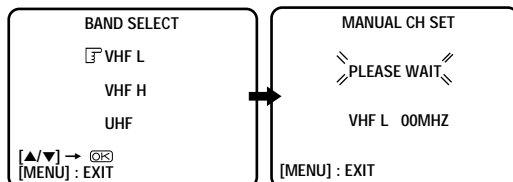

4 SET DESIRED STATION

The screen to the right appears when a station is detected. To store the detected station, place the pointer next to "STORE" by pressing **PUSH JOG** $\Delta\nabla$, then press **OK**. If you do not want to store the station, press **PUSH JOG** $\Delta\nabla$ to place the pointer next to "CONTINUE", then press **OK**. Channel search will resume.

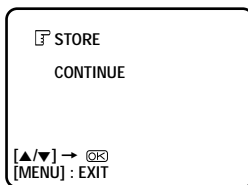

- The blueback screen and the TV picture currently being broadcast appear alternately for 8 seconds each.

5 PERFORM TUNING

For fine tuning adjustment, press **PUSH JOG** $\Delta\nabla$ until the picture becomes clearer, then press **OK**.

- The SYSTEM section will blink.

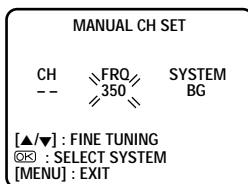

6 SELECT TV SYSTEM

If you can see the picture but hear no audio, set "SYSTEM" to the appropriate TV system (BG or DK or I) by pressing **PUSH JOG** $\Delta\nabla$, then press **OK**.

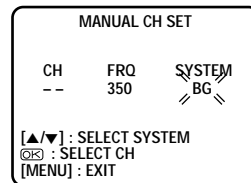

- The CH section will blink.

7 SELECT POSITION

Press **NUMBER** keys to input an open channel position in which you want to store the detected station (for a one-digit number, enter "0" first). Then press **OK**.

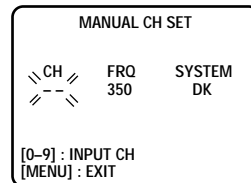

- To continue channel search, press **PUSH JOG** $\Delta\nabla$ to select "CONTINUE", then press **OK**. Repeat steps 4 – 7 as necessary.
- To set channels for other bands, press **PUSH JOG** $\Delta\nabla$ to select "BAND SELECT", then press **OK** to go back to the Band Select screen. Repeat steps 3 – 7.

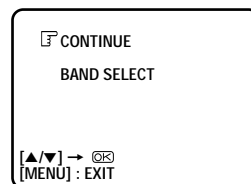

8 RETURN TO NORMAL SCREEN

Press **MENU**.

Delete A Channel

1 ACCESS TUNER SET SCREEN
Perform steps 1 – 3 of "Auto Channel Set" on page 24.

2 ACCESS CHANNEL LIST
Press **PUSH JOG** $\Delta \nabla$ to place the pointer next to "CH EDIT", then press **OK**.

3 SELECT CHANNEL
Press **PUSH JOG** $\Delta \nabla$ to until the channel you want to delete begins blinking.

CH	FREQ	SYS	CH	FREQ	SYS
01	150	BG	07	229	BG
02	165	BG	08	237	BG
03	195	BG	09	355	BG
04	205	BG	10	365	BG
05	213	BG	11	374	BG
06	221	BG	12	384	BG

[▲/▼] → [◀]: DELETE
[▲/▼] → [⊞]: EDIT
[MENU]: EXIT

4 DELETE CHANNEL
Press \triangleleft .

- To re-store it, simply press \triangleright .
- Repeat steps 3 – 4 as necessary.

CH	FREQ	SYS	CH	FREQ	SYS
01	--	BG	07	229	BG
02	165	BG	08	237	BG
03	195	BG	09	355	BG
04	205	BG	10	365	BG
05	213	BG	11	374	BG
06	221	BG	12	384	BG

[▲/▼] → [▶]: ADD
[MENU]: EXIT

5 RETURN TO NORMAL SCREEN
Press **MENU**.

Swap Channel Positions

Example: To swap CH03 and CH09.

1 ACCESS TUNER SET SCREEN
Perform steps 1 – 3 of "Auto Channel Set" on page 24.

2 ACCESS CHANNEL LIST
Press **PUSH JOG** $\Delta \nabla$ to place the pointer next to "CH EDIT", then press **OK**.

3 SELECT POSITION (e.g. 03)
Press **PUSH JOG** $\Delta \nabla$ until the section of CH "03" begins blinking, then press **OK**.

CH	FREQ	SYS	CH	FREQ	SYS
01	150	BG	07	229	BG
02	165	BG	08	237	BG
03	195	BG	09	355	BG
04	205	BG	10	365	BG
05	213	BG	11	374	BG
06	221	BG	12	384	BG

[0 - 9]: INPUT CH
[⊞]: FINE TUNING
[MENU]: EXIT

- Only "03" will blink.

4 SELECT POSITION (e.g. 09)
Press **NUMBER** keys to input "0" and "9".

CH	FREQ	SYS	CH	FREQ	SYS
01	150	BG	07	229	BG
02	165	BG	08	237	BG
03	355	BG	09	195	BG
04	205	BG	10	365	BG
05	213	BG	11	374	BG
06	221	BG	12	384	BG

[◀]: CANCEL
[⊞]: OK
[MENU]: EXIT

- The two selected channels will be swapped.
- To cancel the channel swapping, press \triangleleft .

5 STORE NEW POSITIONS
Press **OK**.

- Repeat steps 3 – 5 as necessary.

6 RETURN TO NORMAL SCREEN
Press **MENU**.

Fine-Tuning Channels

1

ACCESS TUNER SET SCREEN

Perform steps 1 – 3 of "Auto Channel Set" on page 24.

2

ACCESS CHANNEL LIST

Press **PUSH JOG** Δ / ∇ to place the pointer next to "CH EDIT", then press **OK**.

3

SELECT CHANNEL TO FINE-TUNE

Press **PUSH JOG** Δ / ∇ until the channel you want to tune begins blinking, then press **OK** twice.

- The "FRO" number for that channel starts blinking.

CH	FRO	SYS	CH	FRO	SYS
01	150	BG	07	229	BG
02	165	BG	08	237	BG
03	195	BG	09	355	BG
04	205	BG	10	365	BG
05	213	BG	11	374	BG
06	221	BG	12	384	BG

[Δ / ∇] : FINE TUNING
 [OK] : SELECT SYSTEM
 [MENU] : EXIT

4

PERFORM TUNING

Press **PUSH JOG** Δ / ∇ until the picture becomes clearer, then press **OK**.

- Repeat steps 3 and 4.

5

RETURN TO NORMAL SCREEN

Press **MENU**.

TV System Selection – When you see the picture but hear no audio

1

ACCESS TUNER SET SCREEN

Perform steps 1 – 3 of "Auto Channel Set" on page 24.

2

ACCESS CHANNEL LIST

Press **PUSH JOG** Δ / ∇ to place the pointer next to "CH EDIT", then press **OK**.

3

SELECT CHANNEL

Press **PUSH JOG** Δ / ∇ until the channel you want to change its TV system begins blinking, then press **OK** three times.

- The "SYS" display for that channel starts blinking.

CH	FRO	SYS	CH	FRO	SYS
01	150	BG	07	229	BG
02	165	BG	08	237	BG
03	195	BG	09	355	BG
04	205	BG	10	365	BG
05	213	BG	11	374	BG
06	221	BG	12	384	BG

[Δ / ∇] : SELECT SYSTEM
 [OK] : OK
 [MENU] : EXIT

4

SELECT TV SYSTEM

Press **PUSH JOG** Δ / ∇ to select the appropriate TV system (BG \rightarrow DK \rightarrow I). Then press **OK**.

- Repeat steps 3 and 4 as necessary.

5

RETURN TO NORMAL SCREEN

Press **MENU**.

Before requesting service for a problem, use this chart and see if you can repair the trouble yourself. Small problems are often easily corrected, and this can save you the trouble of sending your video recorder off for repair.

POWER

SYMPTOM	POSSIBLE CAUSE	CORRECTIVE ACTION
1. No power is applied to the recorder.	<ul style="list-style-type: none"> The mains power cord is disconnected. 	Connect the mains power cord.
2. The clock is functioning properly, but the recorder cannot be powered.	<ul style="list-style-type: none"> "⊖" is displayed on the display panel with Auto Timer set to "OFF". 	Press the TIMER button to turn the "⊖" indicator off.

TAPE TRANSPORT

SYMPTOM	POSSIBLE CAUSE	CORRECTIVE ACTION
1. The tape does not run during recording.	<ul style="list-style-type: none"> "□□" is displayed on the display panel. 	Press PLAY to turn the "□□" indicator off.
2. The tape stops during rewind or fast-forward.	<ul style="list-style-type: none"> "M" is displayed on the display panel. 	Press C.MEMORY to deactivate the Counter Memory function and turn the "M" indicator off.
3. The tape will not rewind or fast-forward.	<ul style="list-style-type: none"> The tape is already fully rewound or fast-forwarded. 	Check the cassette.

PLAYBACK

SYMPTOM	POSSIBLE CAUSE	CORRECTIVE ACTION
1. The playback picture does not appear while the tape is running.	<ul style="list-style-type: none"> If you're using the RF OUT connection the TV receiver's channel selector is not set to the VIDEO channel. the recorder's VIDEO channel has not been correctly set. If you're using the AV connection, the TV receiver is not set to the AV mode. 	<p>If you are using the RF OUT connection set the TV receiver to the VIDEO channel. (☞ pg. 5)</p> <p>. Perform "Video Channel Set" (☞ pg. 5)</p> <p>If you are using the AV connection, set the TV to its AV mode.</p>
2. Noise appears during visual search.	<ul style="list-style-type: none"> This is normal. 	
3. Noise appears during normal playback.	<ul style="list-style-type: none"> The automatic tracking mode is engaged. 	Try manual tracking. (☞ pg. 12)
4. Noise appears during slow-motion playback.	<ul style="list-style-type: none"> The automatic tracking mode is engaged. 	Try manual tracking. (☞ pg. 12)
5. Noise appears during still playback.		Press TV PROG + or - a few times to remove the noise bars from the screen.
6. The playback picture is blurred or interrupted while TV broadcasts are clear.	<ul style="list-style-type: none"> The video heads may be dirty. 	Consult your JVC dealer.
7. Playback picture has a loss of colour.	<ul style="list-style-type: none"> The wrong colour system is selected for the tape being played back. The wrong colour system was selected during recording. 	<p>Select the correct colour system by pressing the COLOUR SYSTEM button. (☞ pg. 22)</p> <p>Once recorded, the signal cannot be corrected. Be sure to choose the correct setting before recording.</p>
8. No sound accompanies the playback picture.	<ul style="list-style-type: none"> The TV system you have selected at the TV System Select screen is incorrect. 	Set it to the correct position for the TV broadcast system used in your area. (☞ pg. 7.)

RECORDING

SYMPTOM	POSSIBLE CAUSE	CORRECTIVE ACTION
1. Recording cannot be started.	<ul style="list-style-type: none"> There is no cassette loaded, or the cassette loaded has had its Record Safety tab removed. 	Insert a cassette, or using adhesive tape, reseal the slot where the tab was removed.

2. TV broadcasts cannot be recorded.	<ul style="list-style-type: none"> ● "AU" has been selected as the input mode. 	Set to the desired channel.
3. Tape-to-tape editing is not possible.	<ul style="list-style-type: none"> ● The source (another video recorder, camcorder) has not been properly connected. ● All necessary power switches have not been turned on. ● The input mode is not correct. 	<p>Confirm that the source is properly connected.</p> <p>Confirm that all units' power switches are turned on. Set the input mode to "AU".</p>
4. Camcorder recording is not possible.	<ul style="list-style-type: none"> ● The camcorder has not been properly connected. ● The input mode is not correct. 	<p>Confirm that the camcorder is properly connected.</p> <p>Set the input mode to "AU".</p>

TIMER RECORDING

SYMPTOM	POSSIBLE CAUSE	CORRECTIVE ACTION
1. Timer recording won't work.	<ul style="list-style-type: none"> ● The clock and/or the timer have been set incorrectly. ● The timer is not engaged. 	Re-perform the clock and/or timer settings. Press TIMER and confirm that "⊖" is displayed on the display panel.
2. On-screen timer programming is not possible.	<ul style="list-style-type: none"> ● Timer recording is in progress. 	Timer programming can't be performed while a timer recording is in progress. Wait until it finishes.
3. "⊖" and "⊞" on the display panel won't stop blinking.	<ul style="list-style-type: none"> ● The timer is engaged but there's no cassette loaded. 	Load a cassette with the Record Safety tab intact, or cover the hole using adhesive tape.
4. The cassette is automatically ejected, and "⊖" and "⊞" on the display panel won't stop blinking.	<ul style="list-style-type: none"> ● The loaded cassette has had its Record Safety tab removed. 	Remove the cassette and cover the hole with adhesive tape, or insert a cassette with the Record Safety tab intact.
5. "⊖" blinks for 10 seconds and the Timer mode is disengaged.	<ul style="list-style-type: none"> ● TIMER has been pressed when there are no programs in memory, or the timer record information has been programmed incorrectly. 	Check the programmed data and re-program as necessary, then press TIMER again.
6. The cassette is automatically ejected, the power shuts off and "⊖" and "⊞" won't stop blinking.	<ul style="list-style-type: none"> ● The end of the tape was reached during timer recording. 	The programme may not have been recorded in its entirety. Next time make sure you have enough time on the tape to record the entire programme.

OTHER PROBLEMS

SYMPTOM	POSSIBLE CAUSE	CORRECTIVE ACTION
1. Whistling or howling is heard from the TV during camcorder recording.	<ul style="list-style-type: none"> ● The camcorder's microphone is too close to the TV. ● The TV's volume is too high. 	Position the camcorder so its microphone is away from the TV. Turn the TV's volume down.
2. When scanning channels, some of them are skipped over.	<ul style="list-style-type: none"> ● Those channels have been designated to be skipped. 	If you need the skipped channels, restore them (⌚ pg. 25).
3. The channel cannot be changed.	<ul style="list-style-type: none"> ● Recording is in progress. 	Press PAUSE to pause the recording, change channels, then press PLAY to resume recording.
4. Channel settings that were made manually seem to have changed or disappeared.	<ul style="list-style-type: none"> ● After the manual settings were made, Auto Channel Set was performed. 	Perform manual setting again.
5. No channels are stored in the recorder's memory.	<ul style="list-style-type: none"> ● The TV aerial cable was not connected to the recorder when Auto Set Up was performed. 	Connect the TV aerial cable to the recorder properly and turn off the recorder power once, then turn the recorder power back on again. The recorder will try Auto Set Up again (⌚ pg. 4).
6. "--:--" is displayed on the front display panel after a power outage.	<ul style="list-style-type: none"> ● The lithium battery is exhausted. 	Replace the lithium battery with a new one. (⌚ pg. 5)

PLAYBACK

- Q. What happens if the end of the tape is reached during playback or search?
A. The tape is automatically rewound to the beginning.
- Q. Can the video recorder indefinitely remain in the still mode?
A. No. It stops automatically after 5 minutes to protect the heads.
- Q. During search, slow, still and frame-by-frame playback, I can't hear any audio. What's the problem?
A. This is normal.
- Q. When returning from multi-speed search to normal playback, the picture is disturbed. Should I be concerned about this?
A. No, it is normal.
- Q. Noise bars appear during multi-speed search. What's the problem?
A. This is normal.
- Q. Other than preventing further recording, what effect does removing the Record Safety tab have?
A. It disables marking of index codes.
- Q. Sometimes, during Index Search, the video recorder can't find the programme I want to see. Why not?
A. There may be index codes too close together.

RECORDING

- Q. When I pause and then resume a recording, the end of the recording before the pause is overlapped by the beginning of the continuation of recording. Why does this happen?
A. This is normal. It reduces distortion at the pause and resume points.
- Q. Can the video recorder indefinitely remain in the Record-Pause mode?
A. No. The video recorder goes to its Stop mode automatically after 5 minutes to protect the heads.
- Q. What happens if the tape runs out during recording?
A. The video recorder automatically rewinds it to the beginning.

TIMER RECORDING

- Q. "○" and "⊖" remain lit on the display panel. Is there a problem?
A. No. This is a normal condition for a timer recording in progress.
- Q. Can I program the timer while I'm watching a tape or a TV broadcast?
A. You won't see the picture as it is replaced by the on-screen menu, but the audio from the program or tape you're viewing can be heard.

ATTENTION:

This recorder contains microcomputers. External electronic noise or interference could cause malfunctioning. In such cases, switch the recorder off and unplug the mains power cord. Then plug it in again and turn the recorder on. Take out the cassette. After checking the cassette, operate the unit as usual.

FRONT VIEW

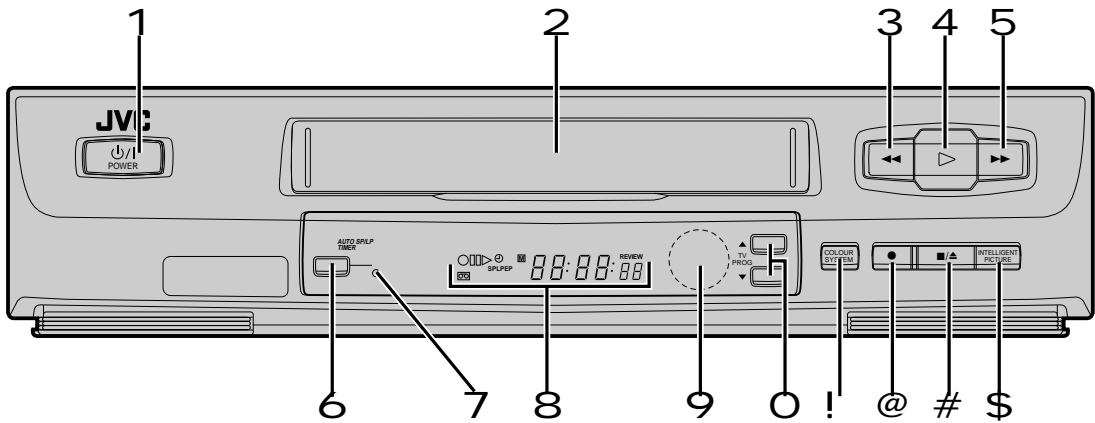

- 1 POWER $\text{\textcircled{P}}$ Button $\text{\textcircled{P}}$ pg. 4
- 2 Cassette Loading Slot
- 3 Rewind [REW] Button $\text{\textcircled{P}}$ pg. 10
- 4 PLAY Button $\text{\textcircled{P}}$ pg. 10
- 5 Fast Forward [FF] Button $\text{\textcircled{P}}$ pg. 10
- 6 AUTO SP/LP TIMER Button $\text{\textcircled{P}}$ pg. 17
- 7 AUTO SP/LP TIMER Indicator $\text{\textcircled{P}}$ pg. 17

- 8 Display Panel $\text{\textcircled{P}}$ pg. 32
- 9 Infrared Beam Receiving Window
- 0 TV PROG $\blacktriangle/\blacktriangledown$ Buttons $\text{\textcircled{P}}$ pg. 14
- ! COLOUR SYSTEM Button $\text{\textcircled{P}}$ pg. 22
- @ RECORD Button $\text{\textcircled{P}}$ pg. 14
- # STOP/EJECT Button $\text{\textcircled{P}}$ pg. 10
- \$ INTELLIGENT PICTURE Button $\text{\textcircled{P}}$ pg. 12

REAR VIEW

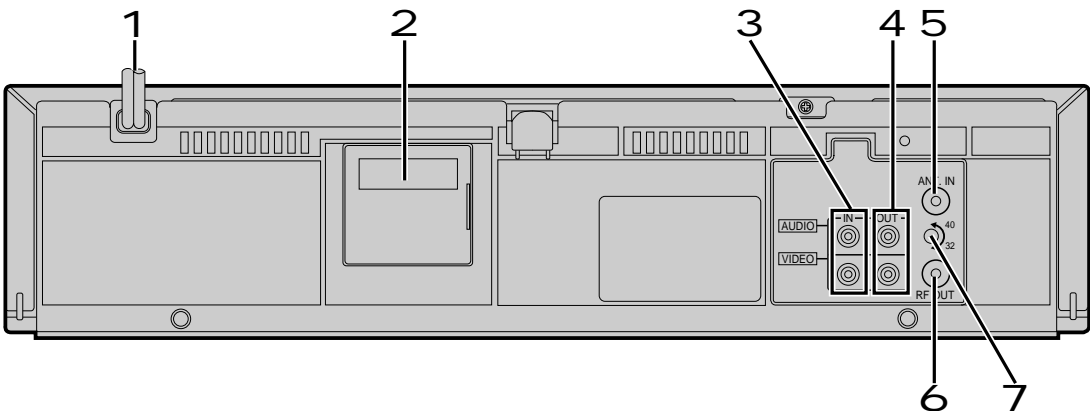

- 1 Mains Power Cord $\text{\textcircled{P}}$ pg. 3
- 2 Lithium Battery Compartment $\text{\textcircled{P}}$ pg. 5
- 3 VIDEO/AUDIO Input Connectors $\text{\textcircled{P}}$ pg. 20, 21
- 4 VIDEO/AUDIO Output Connectors $\text{\textcircled{P}}$ pg. 3, 20

- 5 ANT. IN Connector $\text{\textcircled{P}}$ pg. 3
- 6 RF OUT Connector $\text{\textcircled{P}}$ pg. 3
- 7 RF Output Channel Adjustment Screw $\text{\textcircled{P}}$ pg. 5

DISPLAY PANEL

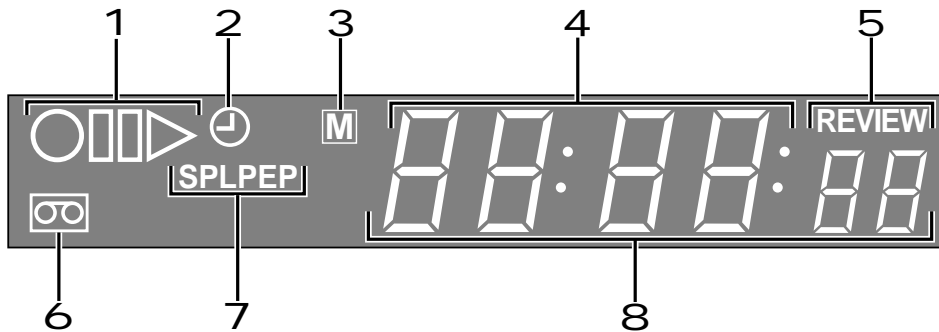

1 Symbolic Mode Indicators

PLAY: FF/REW VARIABLE SHUTTLE SEARCH:	▶	STILL: SLOW:	▢▢▶
		RECORD:	○
		RECORD PAUSE:	○▢▢

2 "Timer" Indicator ☞ pg. 17

3 Counter Memory Indicator ☞ pg. 13

4 Channel*/Mode Display ☞ pg. 14

*Channel position 1 will be displayed as "CH 1".

Clock Display ☞ pg. 8

5 Instant REVIEW Indicator ☞ pg. 13

6 "Cassette Loaded" Mark

7 Tape Speed Indicators ☞ pg. 14

8 Counter Display ☞ pg. 15

REMOTE CONTROL

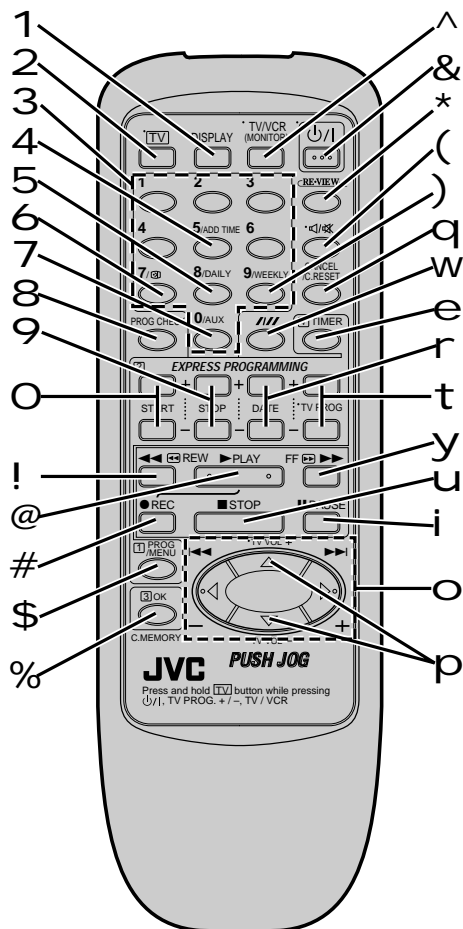

- 1 DISPLAY Button pg. 15
- 2 TV Button (See below)
- 3 NUMBER Keys pg. 14
- 4 ADD TIME Button (No function with this recorder.)
- 5 DAILY Button pg. 17
- 6 (PDC/VPS) Button (No function with this recorder.)
- 7 AUX Button pg. 20
- 8 PROG CHECK Button pg. 19
- 9 STOP +/- Button pg. 16
- 0 START +/- Button pg. 16
- ! Rewind [REW] Button pg. 10
- @ Play Button pg. 10
- # Record Button pg. 14
- \$ PROG/MENU Button pg. 6, 16
- % OK Button pg. 8
- ^ C. MEMORY Button pg. 13
- ^ TV/VCR Button (See below)
- & POWER Button pg. 4
- * REVIEW Button pg. 13
- ((TV Mute) Button (See below)
-) WEEKLY Button pg. 17
- q CANCEL Button pg. 19
- q C. RESET Button pg. 13
- w SP/LP/EP Button pg. 14
- e TIMER Button pg. 17
- r DATE +/- Button pg. 16
- t TV PROG +/- Button pg. 14
- y Fast Forward [FF] Button pg. 10
- u Stop Button pg. 10
- i Pause Button pg. 11
- o PUSH JOG Button pg. 6
- o PUSH JOG Button pg. 11, 13
- p TV VOL Button (See below)

Installing Batteries

- 1 Open the battery compartment cover.
- 2 Insert 2 "R6/UM-3"-size batteries (provided) in the correct directions.
- 3 Replace the cover.

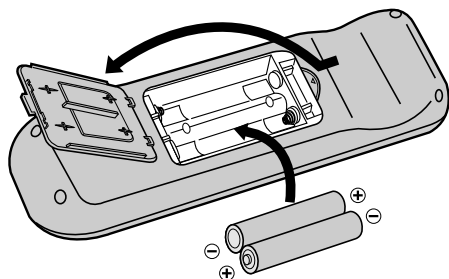

How To Use

The remote control can operate most of your video recorder's functions, as well as basic functions of JVC TV sets. (See below)

- Point the remote control toward the sensor window.
- The maximum operating distance of the remote control is about 8 m.

Operating JVC TVs

To operate your TV, while holding down TV, press the corresponding button: POWER , TV/VCR, TV PROG +/-, (TV Mute), (to select either Main or Sub programmes). TV VOL +/- can be used without holding down TV.

NOTES:

- Depending on the type of JVC TV, there may be cases where some or all functions cannot be operated using the remote control.
- If the remote control doesn't work properly, remove its batteries, wait a short time, replace the batteries and then try again.

GENERAL

Power requirement	
Rating	: AC 110 – 240 V~, 50/60 Hz
Operating	: AC 90 – 260 V~, 50/60 Hz
Power consumption	: 18 W
Temperature	
Operating	: 5°C to 40°C
Storage	: -20°C to 60°C
Operating position	: Horizontal only
Dimensions (WxHxD)	: 400 x 94 x 276 mm
Weight	: 3.3 kg
Format	: VHS standard
Maximum recording time	
(SP)	: 240 min. with E-240 video cassette (PAL/MESECAM) : 160 min. with T-160 video cassette (NTSC)
(LP)	: 480 min. with E-240 video cassette (PAL/MESECAM)
(EP)	: 480 min. with T-160 video cassette (NTSC)

VIDEO/AUDIO

Signal system	: PAL-type colour signal and CCIR monochrome signal, 625 lines 50 fields : NTSC colour and EIA monochrome signals, 525 lines/60 fields
Recording system	: Rotary two-head helical scan system
Signal-to-noise ratio	: 45 dB
Horizontal resolution	: 250 lines (PAL/MESECAM) : 220 lines (NTSC)
Frequency range	: 70 Hz to 10,000 Hz
Input/Output	: RCA connectors (IN x 1, OUT x 1)

TUNER/TIMER

TV channel storage capacity	: 99 positions (+AUX position "AU")
Tuning system	: Frequency synthesized tuner
Channel coverage	: VHF (Low) 42 – 175MHz (High) 175 – 470MHz UHF 470 – 870MHz
Aerial output	: UHF channels (Adjustable E32 – E40)
Memory backup time	: Approx. 6 months. Estimated figure based on supplied fresh battery; actual performance may differ.

ACCESSORIES

Provided accessories	: RF cable, Infrared remote control unit, "R6/UM-3" battery x 2, Lithium battery CR2025
----------------------	--

*Specifications shown are for SP mode unless otherwise specified.
Design and specifications subject to change without notice.*

JVC
VICTOR COMPANY OF JAPAN, LIMITED