

**acer**  
*explore beyond limits™*

**ICONIA** | W700



© 2012. All Rights Reserved.

Acer ICONIA User Manual

Models: W700 / W700P

First issue: 19 September 2012

# TABLE OF CONTENTS

---

<b>Safety and comfort</b>	<b>5</b>	<b>Acer Ring</b>	<b>37</b>
<b>First things first</b>	<b>15</b>	<b>Device Control</b>	<b>39</b>
Your guides .....	15	<b>Acer clear.fi</b>	<b>40</b>
Basic care and tips for using your computer .....	15	Navigating media and photos .....	40
Turning your computer on and off .....	15	Shared files .....	41
Taking care of your computer .....	16	Which devices are compatible? .....	41
Taking care of your AC adapter .....	17	Playing to another device .....	42
Cleaning and servicing .....	17	<b>Screen orientation</b>	
<b>Your Acer tablet PC tour</b>	<b>19</b>	<b>and G-sensor</b>	<b>43</b>
Tablet PC .....	19	<b>Power management</b>	<b>44</b>
Front view .....	20	Acer Green Instant On .....	44
Back view .....	21	Saving power .....	45
Top view .....	21	<b>Battery pack</b>	<b>48</b>
Bottom view .....	22	Battery pack characteristics .....	48
Left/right views .....	23	Charging the battery .....	48
LED Indicators .....	25	Optimizing battery life .....	50
Connect the tablet to the cradle .....	25	Checking the battery level .....	51
Tablet cradle .....	26	Battery-low warning .....	51
Front view .....	27	<b>Securing your computer</b>	<b>53</b>
Back view (stand not shown) .....	28	Using passwords .....	53
Left view (stand not shown) .....	29	Entering passwords .....	54
Environment .....	30	<b>Frequently asked questions</b>	<b>55</b>
<b>Universal Serial Bus (USB)</b>	<b>31</b>	Requesting service .....	56
<b>HDMI Micro</b>	<b>32</b>	Tips and hints for using Windows 8 .....	58
<b>Using the virtual keyboard</b>	<b>33</b>	Three concepts you might want to keep in mind .....	58
<b>Wireless networks</b>	<b>35</b>	How do I access the charms? .....	58
Connecting to the Internet .....	35	How do I get to Start? .....	58
Wireless networks .....	35		

How do I jump between apps?.....	59	updates? .....	64
How do I turn off my computer?.....	59	Where can I get more information?.....	64
Why is there a new interface?.....	59	Troubleshooting.....	65
How do I unlock my computer?.....	59	Troubleshooting tips.....	65
How do I personalize my computer?.....	60	Error messages.....	65
I want to use Windows in the way that I'm used to - give me my desktop back!.....	61	<b>Recovering your system</b>	<b>67</b>
Where are my apps?.....	61	<b>BIOS utility</b>	<b>68</b>
What is a Microsoft ID (account)?.....	63	Boot sequence.....	68
How do I add a favorite to Internet Explorer?.....	63	Setting passwords .....	68
How do I check for Windows		<b>Regulations and safety notices</b>	<b>69</b>

# SAFETY AND COMFORT

---

## **SAFETY INSTRUCTIONS**

Read these instructions carefully. Keep this document for future reference. Follow all warnings and instructions marked on the product.

### **Turning the product off before cleaning**

Unplug this product from the wall outlet before cleaning. Do not use liquid cleaners or aerosol cleaners. Use a damp cloth for cleaning.

## **WARNINGS**

### **Accessing the power cord**

Be sure that the power outlet you plug the power cord into is easily accessible and located as close to the equipment operator as possible. When you need to disconnect power to the equipment, be sure to unplug the power cord from the electrical outlet.

### **Disconnecting the power source**

Observe the following guidelines when connecting and disconnecting power to the power supply unit:

Install the power supply unit before connecting the power cord to the AC power outlet.

Unplug the power cord before removing the power supply unit from the computer.

If the system has multiple sources of power, disconnect power from the system by unplugging all power cords from the power supplies.

### **Using electrical power**

- This product should be operated from the type of power indicated on the marking label. If you are not sure of the type of power available, consult your dealer or local power company.
- Do not allow anything to rest on the power cord. Do not locate this product where people will walk on the cord.

- If an extension cord is used with this product, make sure that the total ampere rating of the equipment plugged into the extension cord does not exceed the extension cord ampere rating. Also, make sure that the total rating of all products plugged into the wall outlet does not exceed the fuse rating.
- Do not overload a power outlet, strip or receptacle by plugging in too many devices. The overall system load must not exceed 80% of the branch circuit rating. If power strips are used, the load should not exceed 80% of the power strip's input rating.
- This product's AC adapter is equipped with a three-wire grounded plug. The plug only fits in a grounded power outlet. Make sure the power outlet is properly grounded before inserting the AC adapter plug. Do not insert the plug into a non-grounded power outlet. Contact your electrician for details.
- **Warning! The grounding pin is a safety feature. Using a power outlet that is not properly grounded may result in electric shock and/or injury.**
- ***Note:** The grounding pin also provides good protection from unexpected noise produced by other nearby electrical devices that may interfere with the performance of this product.*
- The system can be powered using a wide range of voltages; 100 to 120 or 220 to 240 V AC. The power cord included with the system meets the requirements for use in the country/region where the system was purchased. Power cords for use in other countries/regions must meet the requirements for that country/region. For more information on power cord requirements, contact an authorized reseller or service provider.

### Protecting your hearing

- **Warning! Permanent hearing loss may occur if earphones or headphones are used at high volume for prolonged periods of time.**



To protect your hearing, follow these instructions.

- Increase the volume gradually until you can hear clearly and comfortably.
- Do not increase the volume level after your ears have adjusted.
- Do not listen to music at high volumes for extended periods.

- Do not increase the volume to block out noisy surroundings.
- Decrease the volume if you can't hear people speaking near you.

### **Bundled dummy cards**

- **Note:** *Information in this section may not apply to your computer.*

Your computer shipped with plastic dummies installed in the card slots. Dummies protect unused slots from dust, metal objects or other particles. Save the dummies for use when no cards are in the slots.

### **General**

- Do not use this product near water.
- Do not place this product on an unstable cart, stand or table. If the product falls, it could be seriously damaged.
- Slots and openings are provided for ventilation to ensure reliable operation of the product and to protect it from overheating. These openings must not be blocked or covered. The openings should never be blocked by placing the product on a bed, sofa, rug or other similar surface. This product should never be placed near or over a radiator or heat register, or in a built-in installation unless proper ventilation is provided.
- Never push objects of any kind into this product through cabinet slots as they may touch dangerous voltage points or short-out parts that could result in a fire or electric shock. Never spill liquid of any kind onto or into the product.
- To avoid damage of internal components and to prevent battery leakage, do not place the product on a vibrating surface.
- Never use it under sporting, exercising, or any vibrating environment which will probably cause unexpected short current or damage rotor devices, HDD, Optical drive, and even exposure risk from lithium battery pack.
- The bottom surface, areas around ventilation openings and AC adapter may get hot. To avoid injury, ensure they do not come in contact with your skin or body.
- Your device and its enhancements may contain small parts. Keep them out of the reach of small children.

## Product servicing

Do not attempt to service this product yourself, as opening or removing covers may expose you to dangerous voltage points or other risks. Refer all servicing to qualified service personnel.

Unplug this product from the wall outlet and refer servicing to qualified service personnel when:

- The power cord or plug is damaged, cut or frayed.
- Liquid was spilled into the product.
- The product was exposed to rain or water.
- The product has been dropped or the case has been damaged.
- The product exhibits a distinct change in performance, indicating a need for service.
- The product does not operate normally after following the operating instructions.
- **Note:** *Adjust only those controls that are covered by the operating instructions, since improper adjustment of other controls may result in damage and will often require extensive work by a qualified technician to restore the product to normal condition.*

## Guidelines for safe battery usage

This computer uses a Lithium-ion or Lithium-polymer battery. Do not use it in a humid, wet or corrosive environment. Do not put, store or leave your product in or near a heat source, in a high temperature location, in strong direct sunlight, in a microwave oven or in a pressurized container, and do not expose it to temperatures over 60° C (140° F). Failure to follow these guidelines may cause the battery to leak acid, become hot, explode or ignite and cause injury and/or damage.

Do not pierce, open or disassemble the battery. If the battery leaks and you come into contact with the leaked fluids, rinse thoroughly with water and seek medical attention immediately.

For safety reasons, and to prolong the lifetime of the battery, charging will not occur at temperatures below 0° C (32° F) or above 40° C (104° F).



The full performance of a new battery is achieved only after two or three complete charge and discharge cycles. The battery can be charged and discharged hundreds of times, but it will eventually wear out. When the operation time becomes noticeably shorter than normal, refer to qualified service personnel. Use only the approved batteries, and recharge your battery only with the approved chargers designated for this device.

Never use any charger or battery that is damaged.

The capacity and lifetime of the battery will be reduced if the battery is left in hot or cold places, such as in a closed car in summer or winter. Always try to keep the battery between 15°C and 25°C (59°F and 77°F). A device with a hot or cold battery may not work temporarily, even when the battery is fully charged. Battery performance is especially limited in temperatures well below freezing.

Do not dispose of batteries in a fire as they may explode. Batteries may also explode if damaged. Dispose of batteries according to local regulations. Please recycle when possible. Do not dispose as household waste.

- **Note:** Please refer to [www.acer.com](http://www.acer.com) for battery shipping documents.
- **Warning! Batteries may explode if not handled properly. Do not disassemble or dispose of them in fire. Keep them away from children. Follow local regulations when disposing of used batteries.**

#### RADIO FREQUENCY INTERFERENCE

- **Warning! For safety reasons, turn off all wireless or radio transmitting devices when using your computer under the following conditions. These devices may include, but are not limited to: wireless LAN (WLAN), Bluetooth and/or 3G.**

Remember to follow any special regulations in force in any area, and always switch off your device when its use is prohibited or when it may cause interference or danger. Use the device only in its normal operating positions. This device meets RF exposure guidelines when used normally, and it and its antenna are positioned at least 1.5 centimeters (5/8 inch) away from your body. It should not contain metal and you should position the device the above-stated distance from your body. To successfully transmit data files or messages, this device requires a good quality connection to the network. In

some cases, transmission of data files or messages may be delayed until such a connection is available. Ensure that the above separation distance instructions are followed until the transmission is completed. Parts of the device are magnetic. Metallic materials may be attracted to the device, and persons with hearing aids should not hold the device to the ear with the hearing aid. Do not place credit cards or other magnetic storage media near the device, because information stored on them may be erased.

### **MEDICAL DEVICES**

Operation of any radio transmitting equipment, including wireless phones, may interfere with the functionality of inadequately protected medical devices. Consult a physician or the manufacturer of the medical device to determine if they are adequately shielded from external RF energy or if you have any questions. Switch off your device in health care facilities when any regulations posted in these areas instruct you to do so. Hospitals or health care facilities may be using equipment that could be sensitive to external RF transmissions.

**Pacemakers.** Pacemaker manufacturers recommend that a minimum separation of 15.3 centimeters (6 inches) be maintained between wireless devices and a pacemaker to avoid potential interference with the pacemaker. These recommendations are consistent with the independent research by and recommendations of Wireless Technology Research. Persons with pacemakers should do the following:

- Always keep the device more than 15.3 centimeters (6 inches) from the pacemaker
- Not carry the device near your pacemaker when the device is switched on.

If you suspect interference, switch off your device, and move it.

**Hearing aids.** Some digital wireless devices may interfere with some hearing aids. If interference occurs, consult your service provider.

### **VEHICLES**

RF signals may affect improperly installed or inadequately shielded electronic systems in motor vehicles such as electronic fuel injection systems, electronic anti-skid (anti-lock) braking systems, electronic speed control systems, and air bag systems. For more information, check with the manufacturer, or its representative, of your vehicle or any

equipment that has been added. Only qualified personnel should service the device, or install the device in a vehicle. Faulty installation or service may be dangerous and may invalidate any warranty that may apply to the device. Check regularly that all wireless equipment in your vehicle is mounted and operating properly. Do not store or carry flammable liquids, gases, or explosive materials in the same compartment as the device, its parts, or enhancements. For vehicles equipped with an air bag, remember that air bags inflate with great force. Do not place objects, including installed or portable wireless equipment in the area over the air bag or in the air bag deployment area. If in-vehicle wireless equipment is improperly installed, and the air bag inflates, serious injury could result. Using your device while flying in aircraft is prohibited. Switch off your device before boarding an aircraft. The use of wireless teledevices in an aircraft may be dangerous to the operation of the aircraft, disrupt the wireless telephone network, and may be illegal.

#### **POTENTIALLY EXPLOSIVE ENVIRONMENTS**

Switch off your device when in any area with a potentially explosive atmosphere and obey all signs and instructions. Potentially explosive atmospheres include areas where you would normally be advised to turn off your vehicle engine. Sparks in such areas could cause an explosion or fire resulting in bodily injury or even death. Switch off the device at refueling points such as near gas pumps at service stations. Observe restrictions on the use of radio equipment in fuel depots, storage, and distribution areas; chemical plants; or where blasting operations are in progress. Areas with a potentially explosive atmosphere are often, but not always, clearly marked. They include below deck on boats, chemical transfer or storage facilities, vehicles using liquefied petroleum gas (such as propane or butane), and areas where the air contains chemicals or particles such as grain, dust or metal powders. Do not switch the computer on when wireless phone use is prohibited or when it may cause interference or danger.

#### **EMERGENCY CALLS**

- **Warning! You cannot make emergency calls through this device. To make an emergency call you shall dial out through your mobile phone or other telephone call system.**

## **DISPOSAL INSTRUCTIONS**

Do not throw this electronic device into the trash when discarding. To minimize pollution and ensure utmost protection of the global environment, please recycle. For more information on the Waste from Electrical and Electronics Equipment (WEEE) regulations, visit [www.acer-group.com/public/Sustainability/sustainability01.htm](http://www.acer-group.com/public/Sustainability/sustainability01.htm)



## **TIPS AND INFORMATION FOR COMFORTABLE USE**

Computer users may complain of eyestrain and headaches after prolonged use. Users are also at risk of physical injury after long hours of working in front of a computer. Long work periods, bad posture, poor work habits, stress, inadequate working conditions, personal health and other factors greatly increase the risk of physical injury.

Incorrect computer usage may lead to carpal tunnel syndrome, tendonitis, tenosynovitis or other musculoskeletal disorders. The following symptoms may appear in the hands, wrists, arms, shoulders, neck or back:

- Numbness, or a burning or tingling sensation.
- Aching, soreness or tenderness.
- Pain, swelling or throbbing.
- Stiffness or tightness.
- Coldness or weakness.

If you have these symptoms, or any other recurring or persistent discomfort and/or pain related to computer use, consult a physician immediately and inform your company's health and safety department.

The following section provides tips for more comfortable computer use.

### **Finding your comfort zone**

Find your comfort zone by adjusting the viewing angle of the monitor, using a footrest, or raising your sitting height to achieve maximum comfort. Observe the following tips:

- Refrain from staying too long in one fixed posture.
- Avoid slouching forward and/or leaning backward.

- Stand up and walk around regularly to remove the strain on your leg muscles.
- Take short rests to relax your neck and shoulders.
- Avoid tensing your muscles or shrugging your shoulders.
- Install the external display, keyboard and mouse properly and within comfortable reach.
- If you view your monitor more than your documents, place the display at the center of your desk to minimize neck strain.

### **Taking care of your vision**

Long viewing hours, wearing incorrect glasses or contact lenses, glare, excessive room lighting, poorly focused screens, very small typefaces and low-contrast displays could stress your eyes. The following sections provide suggestions on how to reduce eyestrain.

#### **Eyes**

- Rest your eyes frequently.
- Give your eyes regular breaks by looking away from the monitor and focusing on a distant point.
- Blink frequently to keep your eyes from drying out.

#### **Display**

- Keep your display clean.
- Keep your head at a higher level than the top edge of the display so your eyes point downward when looking at the middle of the display.
- Adjust the display brightness and/or contrast to a comfortable level for enhanced text readability and graphics clarity.
- Eliminate glare and reflections by:  
placing your display in such a way that the side faces the window or any light source,  
minimizing room light by using drapes, shades or blinds,  
using a task light,  
changing the display's viewing angle,

using a glare-reduction filter,  
using a display visor, such as a piece of cardboard extended from the display's top front edge.

- Avoid adjusting your display to an awkward viewing angle.
- Avoid looking at bright light sources for extended periods of time.

### **Developing good work habits**

The following work habits make computer use more relaxing and productive:

- Take short breaks regularly and often.
- Perform some stretching exercises.
- Breathe fresh air as often as possible.
- Exercise regularly and maintain a healthy body.
- **Warning! We do not recommend using the computer on a couch or bed. If this is unavoidable, work for only short periods, take breaks regularly, and do some stretching exercises.**
- **Note:** *For more information, please refer to "Regulations and safety notices" on page 69.*

# FIRST THINGS FIRST

---

We would like to thank you for making an Acer computer your choice for meeting your mobile computing needs.

## Your guides

To help you use your Acer computer, we have designed a set of guides: First off, the **setup poster** helps you get started with setting up your computer.

The **Quick Guide** introduces you to the basic features and functions of your new computer.

The **User's Manual** contains detailed information on such subjects as system utilities, data recovery, expansion options and troubleshooting. In addition it contains general regulations and safety notices for your computer. It is available in Apps (swipe upwards from the bottom of the screen and tap **All apps** then tap **Acer User's Manual** from the list). Alternatively, swipe the right-hand edge of the screen inwards and tap **Search**, tap the text box to open the onscreen keyboard and start typing 'User's Manual' to display the results; tap **Acer User's Manual**.

## Basic care and tips for using your computer

### Turning your computer on and off

To turn the power off completely, do any of the following:

- Press and hold the power button for at least four seconds (the power button's battery LED should be off).
- Tap the **Settings** charm > **Change PC settings** > **General**. Under "Advanced startup", tap **Restart now**. The "Choose an option" screen displays. Tap **Turn off your PC**.

To put the computer in hibernate, do the following:

- Use the Windows shutdown command: Tap the **Settings** charm > **Power** > **Shut Down**.

If you need to power down the computer for a short while, but don't want to completely shut it down, you can put it into *Sleep mode* by:

- pressing the power button.
- OR -

Tapping the **Settings** charm > **Power** > **Sleep**.

**Note:** *If you cannot power off the computer normally, press and hold the power button for more than four seconds to shut down the computer. If you turn off the computer and want to turn it on again, wait at least two seconds before powering up.*

## Taking care of your computer

Your computer will serve you well if you take care of it.

- Do not expose the computer to direct sunlight. Do not place it near sources of heat, such as a radiator.
- Do not expose the computer to temperatures below 0° C (32° F) or above 50° C (122° F).



- Do not subject the computer to magnetic fields.
- Do not expose the computer to rain or moisture.
- Do not spill water or any liquid on the computer.
- Do not subject the computer to heavy shock or vibration.
- Do not expose the computer to dust or dirt.
- Never place objects on top of the computer.
- Do not slam the computer display when you close it.
- Never place the computer on uneven surfaces.

### **Taking care of your AC adapter**

Here are some ways to take care of your AC adapter:

- Do not connect the adapter to any other device.
- Do not step on the power cord or place heavy objects on top of it. Carefully route the power cord and any cables away from foot traffic.
- When unplugging the power cord, do not pull on the cord itself but pull on the plug.
- The total ampere ratings of the equipment plugged in should not exceed the ampere rating of the cord if you are using an extension cord. Also, the total current rating of all equipment plugged into a single wall outlet should not exceed the fuse rating.

### **Cleaning and servicing**

When cleaning the computer, follow these steps:

1. Turn off the computer.
2. Disconnect the AC adapter.
3. Use a soft, moist cloth. Do not use liquid or aerosol cleaners.

If either of the following occurs:

- The computer has been dropped or the body has been damaged;
- The computer does not operate normally

Please refer to "**Frequently asked questions**" on page 55.

# YOUR ACER TABLET PC TOUR

---

After setting up your computer as illustrated in the setup poster, let us show you around your new Acer computer.

You can enter information into you new computer via the touchscreen.

## Tablet PC

Your new computer has two components: the tablet and the tablet cradle. The following set of images will show you both of these. The views are labeled as if you are holding the Tablet with the screen towards you and the camera at the top.

## Front view

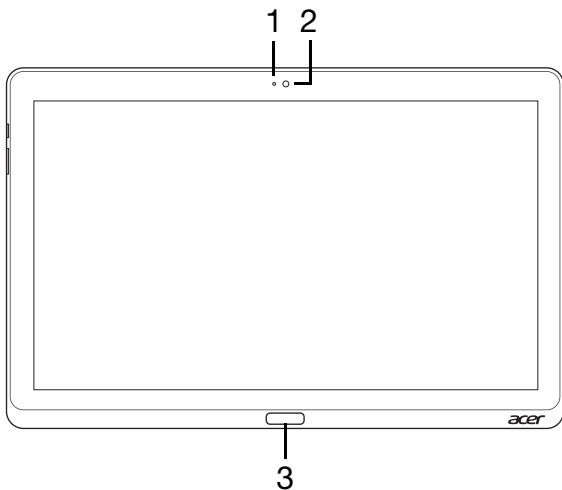

No.	Item	Description
1	Camera indicator light	Lights up when camera is active.
2	Integrated webcam	Web camera for video communication.
3	Windows key	Press once to open the Start menu.

## Back view

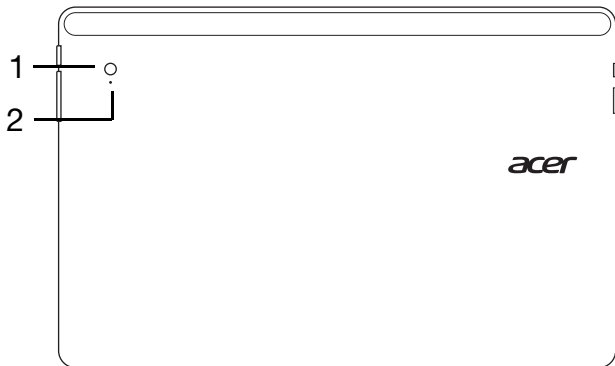

No.	Item	Description
1	Integrated webcam	Web camera for video communication.
2	Camera indicator light	Lights up when camera is active.

## Top view

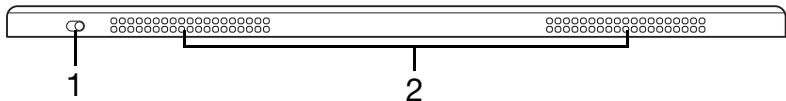

No.	Item	Description
1	Lock switch	Locks the screen orientation.

No.	Item	Description
2	Ventilation and cooling fan	Allows the computer to stay cool. <i>Do not cover or obstruct the openings.</i>

**Note:** Display orientation may be fixed when apps designed for a specific orientation are running. These include games and other full-screen apps. When making video calls, you should always hold the tablet in landscape orientation.

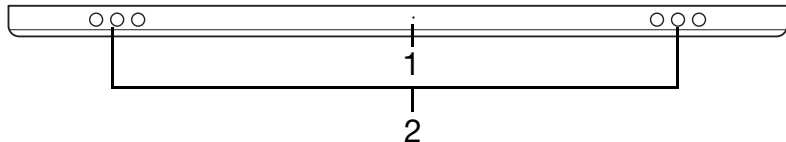

### Bottom view





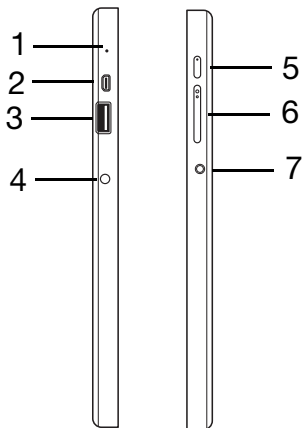

No.	Item	Description
1	Reset button	Insert a paperclip into the hole and press for four seconds to reset the computer (simulates removing and reinstalling the battery).
2	Speakers	Delivers stereo audio output.

## Left/right views



No.	Icon	Item	Description
1		Microphone	Internal microphone for sound recording.
2		micro HDMI port	Supports high-definition digital video connections.
3		USB 3.0 port	Connects to USB devices. A USB 3.0 port can be distinguished by its blue connector (see below). When using the cradle's USB ports, it is recommended to plug in the power adapter.

No.	Icon	Item	Description
4		DC-in jack	Connects to an AC adapter.
		Power button	Press to turn the tablet on; press again to place the tablet in Sleep mode. Press and hold to turn the tablet off.
5		Battery LED	Indicates the computer's battery status. See 1. <b>Charging:</b> Amber. 2. <b>Fully charged:</b> Blue when plugged in.
6		Volume key	Press to increase or decrease volume.
7		Headset/speaker jack	Connects to audio devices (e.g., speakers, headphones) or a headset with microphone.

### Information on USB 3.0

- Compatible with USB 3.0 and earlier USB devices.
- For optimal performance, use USB 3.0-certified devices.
- Defined by the USB 3.0 (SuperSpeed USB) specification.



## LED Indicators

LED color	State	Description
Blue	Steady	The computer is fully charged and plugged in.
Blue	On briefly	The computer is fully charged and running on battery power. After pressing the power button, the blue LED stays lit for a few seconds before turning off.
Amber	Steady	The computer is charging and plugged in.
Amber	On briefly	The computer is not fully charged and running on battery power. After pressing the power button, the amber LED stays lit for a few seconds before turning off.
Amber	Blinking	The battery is critically low or abnormal battery situation.
Off		The computer is off.

## Connect the tablet to the cradle

This multi-position cradle makes it simple to dock your tablet because you don't have to worry about aligning ports and connectors or placing the

tablet at the correct angle. Simply rest the tablet in the cradle and slide it to the left until it stops.

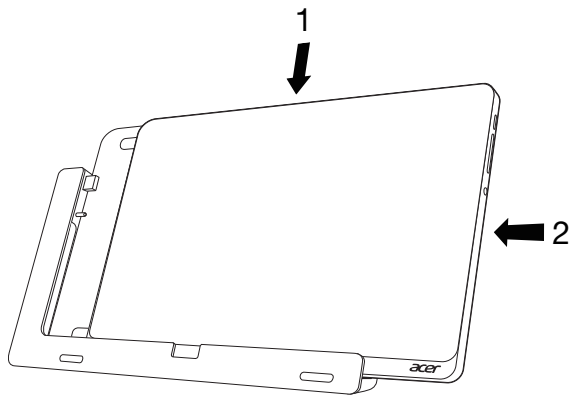



## Tablet cradle

The following set of images show you the bundled cradle.

***NOTE:*** In some countries the cradle is optional.

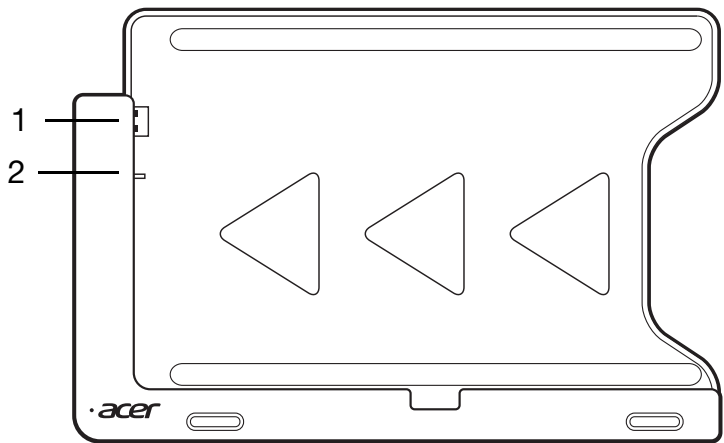
## Front view



No.	Icon	Item	Description
1		USB connector	Connects to the tablet's USB port.
2		DC-out jack	Provides power from the cradle to the tablet

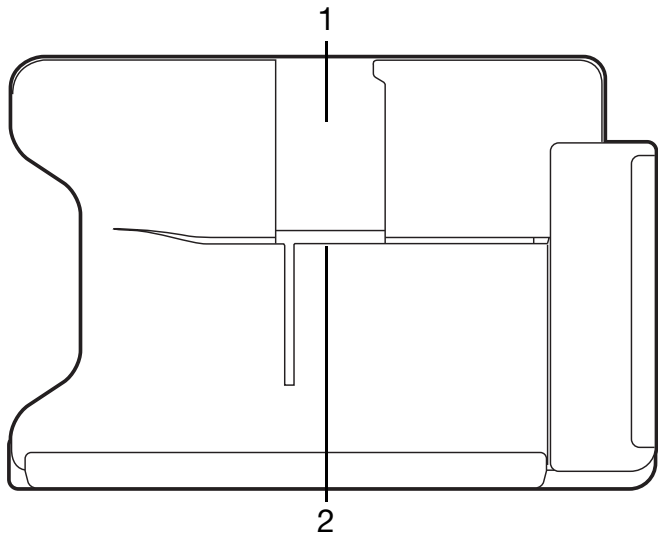

## Back view (stand not shown)

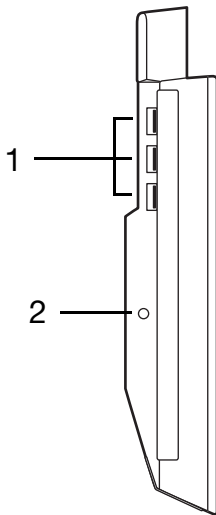

No.	Item	Description
1	Portrait view slot	Insert the stand here to rest the tablet in portrait view.
2	Landscape view slot	Insert the stand here to rest the tablet in landscape view.

## Left view (stand not shown)



No.	Icon	Item	Description
1		USB 3.0 ports	Connect to USB devices. A USB 3.0 port can be distinguished by its blue connector (see below).
2		DC-in jack	Provides power to the cradle.

### Information on USB 3.0

- Compatible with USB 3.0 and earlier USB devices.
- For optimal performance, use USB 3.0-certified devices.
- Defined by the USB 3.0 (SuperSpeed USB) specification.

## **Environment**

- Temperature:
  - Operating: 5 °C to 35 °C
  - Non-operating: -20 °C to 65 °C
- Humidity (non-condensing):
  - Operating: 20% to 80%
  - Non-operating: 20% to 80%

# UNIVERSAL SERIAL BUS (USB)

---

The USB port is a high-speed serial bus which allows you to connect USB peripherals without taking up system resources.

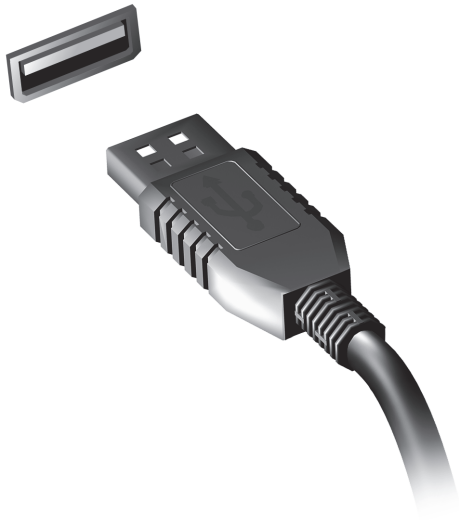

# HDMI MICRO

---

HDMI (High-Definition Multimedia Interface) is an industry-supported, uncompressed, all-digital audio/video interface. HDMI provides an interface between any compatible digital audio/video source, such as a set-top box, DVD player, and A/V receiver and a compatible digital audio and/or video monitor, such as a digital television (DTV), over a single cable.

Use the HDMI Micro port on your computer to connect with high-end audio and video equipment. Single cable implementation allows tidy setup and fast connection.





# USING THE VIRTUAL KEYBOARD

---

Microsoft Windows provides a convenient virtual keyboard for entering data. There are several ways to display the keyboard:

Tap inside any text field to display the Windows virtual keyboard.

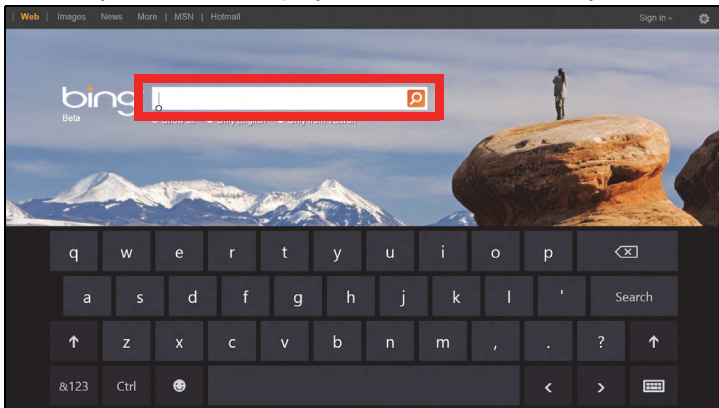

From Desktop, tap the **Keyboard** icon in the system tray to display the keyboard. Tap the "x" in the keyboard's top-right corner to close the keyboard.

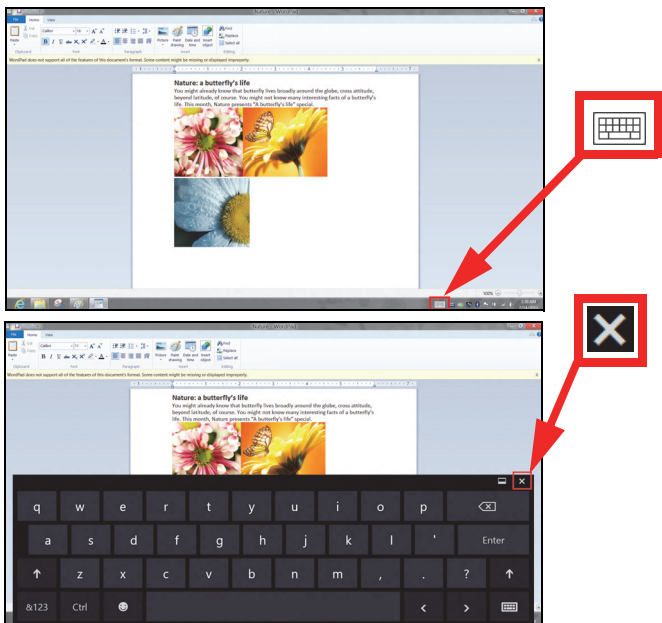

# WIRELESS NETWORKS

---

## Connecting to the Internet

Your computer's wireless connection is turned on by default.

Windows will detect and display a list of available networks during setup. Select your network and enter the password if required.

Otherwise, open Internet Explorer and follow the instructions.

Please refer to your ISP or router documentation.

## Wireless networks

A wireless LAN or WLAN is a wireless local area network, which may link two or more computers without using wires. Setting up a wireless network is easy and allows you to share files, peripheral devices and an Internet connection.

### *What are benefits of a wireless network?*

#### *Mobility*

Wireless LAN systems allow you and other users of your home network to share access to files and devices connected to the network, for example a printer or scanner.

Also you can share an internet connection with other computers in your home.

### *Installation speed and simplicity*

Installing a wireless LAN system can be fast and easy and eliminates the need to pull cables through walls and ceilings.

### *Components of a wireless LAN*

To set up your Wireless network at home you need to have the following:



#### *Access point (router)*



Access points (routers) are two-way transceivers that broadcast data into the surrounding environment. Access points act as a mediator between wired and wireless network. Most routers have a built-in DSL modem that will allow you access to a high speed DSL internet connection. The ISP (Internet Service Provider) you have chosen normally supplies a modem/router with the subscription to their services. Read carefully the documentation supplied with your Access point/router for detailed setup instructions.

# ACER RING

Acer Ring incorporates a number of useful functions and tools in one easy-to-use interface. Tap the touchscreen with all five fingers at once to display Acer Ring.



Icon	Item	Description
	Document	Import documents here for quick access.
	Photo	View pictures stored in your computer.
	Device Control	Adjust settings for your computer (please refer to " <b>Device Control</b> " on page 39).

Icon	Item	Description
	Video	Play videos stored in your computer.
	Favorite Apps	Quickly access your favorite desktop apps.
	Music	Play music stored in your computer. Controls visible from Acer Ring include <b>Previous track</b> , <b>Play</b> , and <b>Next track</b> . A volume slider control is located on the right side of Acer Ring.

To the left of Acer Ring you can see a selection of AppCards. These AppCards are thumbnails of links, files, or apps depending on what section you have selected from Acer Ring. Scroll through the AppCards and tap on a card to open it.

# DEVICE CONTROL

Device Control is a convenient way for you to access frequently-used computer controls: adjust the screen brightness, turn on or off the backlight, toggle wireless connectivity technologies on or off, and enable or disable Acer gestures (such as Acer Ring's five finger tap).



# ACER CLEAR.FI

---

**Note:** Only for certain models.

With Acer clear.fi, you can enjoy videos, photos and music. Stream media from, or to, other devices with Acer clear.fi installed.

**Note:** All devices must be connected to the same network.

To watch videos or listen to music open **clear.fi Media**, to browse photos open **clear.fi Photo**.

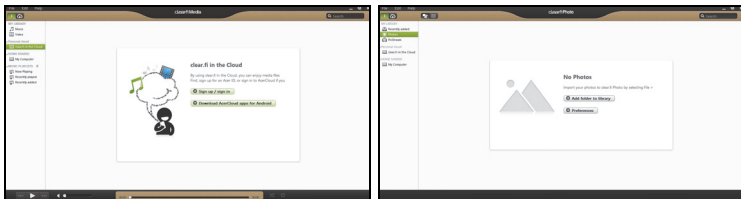

**Important:** When you first open a clear.fi application, Windows Firewall will ask for permission to allow clear.fi to access the network. Select **Allow Access** in each window.

## Navigating media and photos

The list in the left panel shows your computer ('My Library'), then other devices if any are connected to your network ('Home Shared').

To view files on your computer, select one of the categories under 'My Library', then browse the files and folder on the right.



## Shared files

Devices connected to your network are shown in the **Home Shared** section. Select a device, then select the category to explore.

After a short delay, shared files and folders are shown on the right. Browse to the file you want to play, then double-click to start playback.

Use the media controls in the bar across the bottom of the screen to control playback. For example, when music is selected, you can play, pause or stop playback, and adjust the volume.



**Note:** You must activate sharing on the device that stores the files. Open *clear.fi* on the device that stores the files, select **Edit** then make sure **Share my library on local network** is active.



## Which devices are compatible?

Certified Acer devices with *clear.fi* or DLNA software can be used with the *clear.fi* software. These include DLNA-compliant PCs, smartphones, and NAS (Network Attached Storage) devices.

## Playing to another device

If you want to play the media on another device, you need to do the following:

1. In the bottom right corner, select **Play to**. 
2. Select the remote device that will be used to play the file.

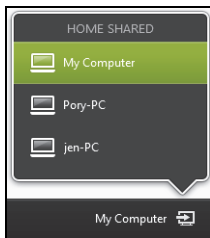

**Note:** Only devices optimised for playback are available in this list, certain PCs and storage devices will not appear. To add a Windows PC to this list, open Windows Media Player, select **Stream** and **Allow remote control of my Player...**

3. Select a file in the main window, then use the media controls in the bar across the bottom of the screen to control the remote device.

For more help, go to <http://www.acer.com/clearfi/download/>.

# SCREEN ORIENTATION AND G-SENSOR

---

Your computer has a built-in accelerometer that detects the tablet's orientation and automatically rotates the screen to suit the orientation.

You can lock the screen orientation by using the lock switch. The orientation may also be locked at other times, including:

- When the tablet is attached to the cradle.
- With an HDMI cable is plugged in.
- When programs designed for a specific orientation are running.

**Note:** *You are advised to keep your tablet in landscape orientation with the webcam above the screen while you are making a video call. Please rotate your display to the landscape orientation and use the lock switch to set the orientation before starting a video call.*

The screen orientation lock status will be indicated via icons briefly displayed onscreen when the status changes.

# POWER MANAGEMENT

---

This computer has a built-in power management unit that monitors system activity. System activity refers to any activity involving one or more of the following devices: keyboard, mouse, hard disk, peripherals connected to the computer, and video memory. If no activity is detected for a period of time, the computer stops some or all of these devices in order to conserve energy.

## Acer Green Instant On

**Note:** *For selected models only.*

The Acer Green Instant On feature allows your computer to wake up from Sleep mode in less than the time it takes to open the lid. When you close the lid, or leave your computer for a while, your computer enters Sleep mode. While the computer is in Sleep mode, the power indicator LED will flash orange.

Open the lid or press any key to wake the computer from Sleep mode.

After a certain amount of time in Sleep mode, the computer will automatically enter Deep Sleep to preserve battery life. When the computer is in Deep Sleep, the power indicator LED will be turned off. In this state, battery remains ready to use for many weeks.

Press the power button to wake up from Deep Sleep.

**Note:** *Once in Deep Sleep, your PC will consume significantly less power compared with Sleep mode, but it will take a little longer to wake up from Deep Sleep.*

Deep Sleep and Sleep mode work together to ensure that your computer saves as much power as possible while still enabling quick, instant on access.

To save more power, your computer will typically enter and stay in Deep Sleep during times when it will not be frequently accessed, for example, during the middle of the night. To provide quicker access, your computer will enter and stay in Sleep mode during times when it will be frequently accessed, for example, during working hours.

## **Saving power**

### *Disable Fast startup*

Your computer uses Fast startup to start quickly, but also uses a small amount of power to check for signals to start. These checks will slowly drain your computer's battery.

If you prefer to reduce your computer's power requirements and environmental impact, turn off Fast startup:

**Note:** *If Fast startup is off, your computer will take longer to start from Sleep. If your computer features Acer Instant On or Acer Always Connect, these will also be turned off.*

*Your computer will also not start if it receives an instruction to start over a network (Wake on LAN).*

1. Open the Desktop.
2. Click **Power Options** in the Notification area.
3. Select **More Power Options**.

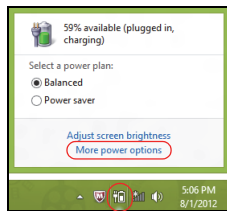

4. Select **Choose what the power buttons do**.
5. To access Shutdown Settings, select **Change settings that are currently unavailable**.

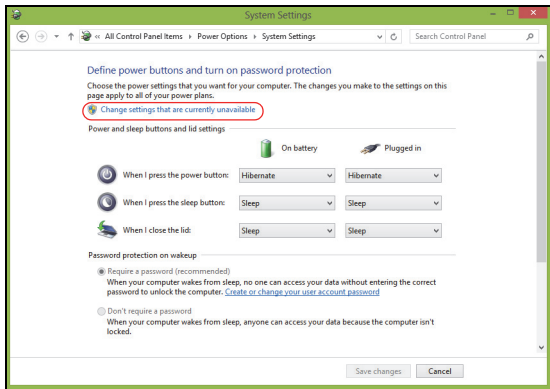

6. Scroll down and disable **Turn on fast startup**.

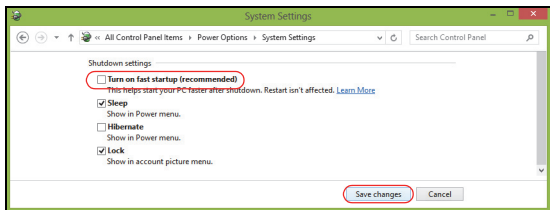

7. Select **Save changes**.

# BATTERY PACK

---

The computer uses an embedded battery pack that gives you long use between charges.

## Battery pack characteristics

The battery pack has the following characteristics:

- Employs current battery technology standards.
- Delivers a battery-low warning.

The battery is recharged whenever you connect the computer to the AC adapter. Your computer supports charge-in-use, enabling you to recharge the battery while you continue to operate the computer. However, recharging with the computer turned off results in a significantly faster charge time.

## Charging the battery

The preferred method of charging your computer is to use the bundled cradle. Plug the AC adapter into the cradle and connect to a power outlet. Insert the tablet into the cradle (see **"Connect the tablet to the cradle" on page 25**). You can continue to operate your computer on AC power while your battery is charging. However, charging the battery with the computer turned off results in a significantly faster charge time.



**Note:** *You are advised to charge the battery before retiring for the day. Charging the battery overnight before traveling enables you to start the next day with a fully charged battery.*

### Conditioning a new battery pack

Before you use a battery pack for the first time, there is a conditioning process that you should follow:

1. Connect the AC adapter and fully charge the battery.
2. Disconnect the AC adapter.
3. Turn on the computer and operate using battery power.
4. Fully deplete the battery until the battery-low warning appears.
5. Reconnect the AC adapter and fully charge the battery again.

Follow these steps again until the battery has been charged and discharged three times.

Use this conditioning process for all new batteries, or if a battery hasn't been used for a long time.

---

**Warning! Do not expose battery packs to temperatures below 0° C (32° F) or above 45° C (113° F). Extreme temperatures may adversely affect the battery pack.**

---

By following the battery conditioning process you condition your battery to accept the maximum possible charge. Failure to follow this procedure will prevent you from obtaining the maximum battery charge, and will also shorten the effective lifespan of the battery.

In addition, the useful lifespan of the battery is adversely affected by the following usage patterns:

- Using the computer on constant AC power.
- Not discharging and recharging the battery to its extremes, as described above.
- Frequent use; the more you use the battery, the faster it will reach the end of its effective life. A standard computer battery has a life span of more than 1,000 charges.

### **Optimizing battery life**

Optimizing battery life helps you get the most out of battery operation, prolonging the charge/recharge cycle and improving recharging efficiency. You are advised to follow the suggestions set out below:

- Use AC power whenever possible, reserving battery for on-the-go use.
- Eject a PC Card if it is not being used, as it will continue to draw power (for selected models).
- Store your PC in a cool, dry place. The recommended temperature is 10° C (50° F) to 30° C (86° F). Higher temperatures cause the battery to self-discharge faster.
- Excessive recharging decreases the battery life.
- Look after your AC adapter and battery.

## Checking the battery level

The Windows power meter indicates the current battery level. Rest the cursor over the battery/power icon on the taskbar to see the battery's present charge level.

## Battery-low warning

When using battery power pay attention to the Windows power meter.

---

**Warning! Connect the AC adapter as soon as possible after the battery-low warning appears. Data will be lost if the battery becomes fully depleted and the computer shuts down.**

---

When the battery-low warning appears, the recommended course of action depends on your situation:

Situation	Recommended Action
The AC adapter, the cradle, and a power outlet are available.	<ol style="list-style-type: none"><li data-bbox="303 593 985 655">1. Plug the AC adapter into the cradle, and then connect to the mains power supply.</li><li data-bbox="303 660 985 686">2. Insert the tablet into the cradle.</li><li data-bbox="303 692 985 717">3. Save all necessary files.</li><li data-bbox="303 723 985 749">4. Resume work.</li></ol> Turn off the computer if you want to recharge the battery rapidly.

---

Situation	Recommended Action
The AC adapter and a power outlet are available.	<ol style="list-style-type: none"><li data-bbox="308 87 984 146">1. Plug the AC adapter into the computer, and then connect to the mains power supply.</li><li data-bbox="308 156 984 184">2. Save all necessary files.</li><li data-bbox="308 194 984 222">3. Resume work.</li></ol> <p data-bbox="308 228 984 288"><b>Turn off the computer if you want to recharge the battery rapidly.</b></p>
The AC adapter or a power outlet is unavailable.	<ol style="list-style-type: none"><li data-bbox="308 304 984 332">1. Save all necessary files.</li><li data-bbox="308 342 984 370">2. Close all applications.</li><li data-bbox="308 381 984 409">3. Turn off the computer.</li></ol>

# SECURING YOUR COMPUTER

---

Your computer is a valuable investment that you need to take care of. Learn how to protect and take care of your computer.

## Using passwords

Passwords protect your computer from unauthorized access. Setting these passwords creates several different levels of protection for your computer and data:

- Supervisor Password prevents unauthorized entry into the BIOS utility. Once set, you must enter this password to gain access to the BIOS utility. **See "BIOS utility" on page 68.**
- User Password secures your computer against unauthorized use. Combine the use of this password with password checkpoints on boot-up and resume from Hibernation (if available) for maximum security.
- Password on Boot secures your computer against unauthorized use. Combine the use of this password with password checkpoints on boot-up and resume from Hibernation (if available) for maximum security.

**Important: Do not forget your Supervisor Password! If you forget your password, please get in touch with your dealer or an authorized service center.**

## Entering passwords

When a password is set, a password prompt appears in the center of the display screen.

- When the Supervisor Password is set, a prompt appears when you enter the BIOS utility at boot-up (**See "BIOS utility" on page 68**).
- Type the Supervisor Password and press <Enter> to access the BIOS utility. If you enter the password incorrectly, a warning message appears. Try again and press <Enter>.
- When the User Password is set and the password on boot parameter is enabled, a prompt appears at boot-up.
- Type the User Password and press <Enter> to use the computer. If you enter the password incorrectly, a warning message appears. Try again and press <Enter>.

**Important: You have three chances to enter a password. After each failed attempt, press the Windows key to try again. If you fail to enter the password correctly after three tries, the system halts. Press and hold the power button for four seconds to shut down the computer. Then turn on the computer and enter the BIOS utility to try again.**

# FREQUENTLY ASKED QUESTIONS

---

The following is a list of possible situations that may arise during the use of your computer. Easy solutions are provided for each one.

## *I turned on the power, but the computer does not start or boot up.*

Look at the power button's battery LED:

- If it is not lit, no power is being supplied to the computer. Check the following:
  - If you are using on the battery, it may be low and unable to power the computer. Connect the AC adapter to recharge the battery pack.
  - Make sure that the AC adapter is properly plugged into the cradle and to the power outlet. Also make sure the tablet fits snug into the cradle.

## *Nothing appears on the screen.*

The computer's power management system automatically blanks the screen to save power. Press the power button to turn the display back on.

If pressing a key does not turn the display back on the brightness level might be too low. Tap the **Settings** charm > **Screen** to adjust the brightness level.

## *No audio is heard from the computer.*

Check the following:

- The volume may be muted. Look at the volume control (speaker) icon by tapping the **Settings** charm > **Volume**. If the speaker has an "x" next to it, tap on the **Volume** icon to display the volume bar. At the top of the bar, tap the speaker icon to un-mute.
- The volume level may be too low. Look at the volume control (speaker) icon by tapping the **Settings** charm > **Volume**. Tap the **Volume** icon and adjust the volume accordingly.
- If headphones, earphones or external speakers are connected to the line-out port on the computer, the internal speakers automatically turn off.

## Requesting service

### *International Travelers Warranty (ITW)*

Your computer is backed by an International Travelers Warranty (ITW) that gives you security and peace of mind when traveling. Our worldwide network of service centers are there to give you a helping hand.

An ITW passport comes with your computer. This passport contains all you need to know about the ITW program. A list of available, authorized service centers is in this handy booklet. Read this passport thoroughly.

Always have your ITW passport on hand, especially when you travel, to receive the benefits from our support centers. Place your proof-of-purchase in the flap located inside the front cover of the ITW passport.

If the country you are traveling in does not have an Acer-authorized ITW service site, you can still get in contact with our offices worldwide. Please visit **www.acer.com**.



### Before you call

Please have the following information available when you call Acer for online service, and please be at your computer when you call. With your support, we can reduce the amount of time a call takes and help solve your problems efficiently. If there are error messages or beeps reported by your computer, write them down as they appear on the screen (or the number and sequence in the case of beeps).

You are required to provide the following information:

Name:

Address:

Telephone number:

Machine and model type:

Serial number:

Date of purchase:

## Tips and hints for using Windows 8

We know this is a new operating system that will take some getting used to, so we've created a few pointers to help you get started.

### Three concepts you might want to keep in mind

#### **1. Start**

The Start button is no longer available; you can launch apps from the Start screen.

#### **2. Tiles**

Live tiles are similar to thumbnails of the apps.

#### **3. Charms**

Charms allow you to perform useful functions, such as sharing content, turning off your PC or changing settings.

### How do I access the charms?

Swipe the right-hand edge of the screen inwards.

### How do I get to **Start**?

Press the Windows key; or swipe the right-hand edge of the screen inwards and tap the **Start** charm.

## How do I jump between apps?

Swipe the left-hand edge of the screen inwards to cycle through apps that are currently running.

## How do I turn off my computer?

Swipe the right-hand edge of the screen inwards, tap **Settings** > **Power** and select the action you'd like to take.

## Why is there a new interface?

The new interface for Windows 8 is designed to work well with touch input. Windows Store apps will automatically use the whole screen and don't require closing in the traditional way. Windows Store apps will be displayed on Start using live-tiles.

### *What are 'live tiles'?*

Live tiles are similar to thumbnails of the app that will be updated with new content whenever you're connected to the Internet. So, for example, you can view weather or stock updates without needing to open the app.

## How do I unlock my computer?

Swipe the lock screen upwards and tap a user account icon to unlock the computer. If your account has a password set, you will need to enter the password to continue.

Tap and hold the *preview* icon to see the characters you've entered to ensure the password is correct.

## How do I personalize my computer?

You can personalize *Start* with a different background image or by arranging the tiles to suit your personal needs.

To change the background, swipe the right-hand edge of the screen inwards and tap **Settings** > **Change PC settings** > **Personalize**. Tap **Start screen** at the top of the page and select a color and image.

### How do I move tiles?

Tap and hold a tile to select it, then drag it to the place on *Start* that you want it to appear. Other tiles will be moved to accommodate the tile in its new location.

### Can I make tiles bigger or smaller?

Tap and drag the tile downwards and release it. Select **Smaller** or **Larger** from the menu that appears at the bottom of the screen.

### How do I personalize the Lock screen?

You can personalize the lock screen with a different image or to show you quick status and notifications to suit your personal needs.

To change the background, swipe the right-hand edge of the screen inwards and tap **Settings** > **Change PC settings** > **Personalize**. Tap **Lock screen** at the top of the page and select the image and apps you would like to see on the lock screen.

### So, how do I close an app?

Swipe the window downwards from the top of the screen, and past the halfway point of the screen.

### Can I change the screen resolution?

Swipe the right-hand edge of the screen inwards and tap **Search**, tap the text box to open the onscreen keyboard and start typing 'Control Panel' to display the results; tap **Control Panel > Adjust screen resolution**.

### I want to use Windows in the way that I'm used to - give me my desktop back!

From *Start* tap the **Desktop** tile to see a traditional desktop. You can pin apps you frequently use to the taskbar to easily open them.

If you click a app that is not a Windows Store app, Windows will automatically open the app using *Desktop*.

### Where are my apps?

Swipe the right-hand edge of the screen inwards and tap **Search**, type the name of the app you would like to open using the pop-up keyboard. Results will be displayed on the left-hand side of the screen.

To view the complete list of apps, swipe upwards from the bottom of the screen and tap **All apps**.

### How do I make an app appear on Start?

If you're in *All apps* and you want to make a app appear on *Start*, tap and drag the app downwards and release it. Tap **Pin to Start** from the menu that appears at the bottom of the screen.

### How do I remove a tile from Start?

Tap and drag the app downwards and release it. Tap **Unpin from Start** from the menu that appears at the bottom of the screen.

### How do I make an app appear on my taskbar in Desktop?

If you're in *All apps* and you want to make a app appear on the taskbar in *Desktop*, tap and drag the app downwards and release it. Select **Pin to taskbar** from the menu that appears at the bottom of the screen.

### How do I install apps?

You can download Windows Store apps from *Store*. You will need to have a Microsoft ID to purchase and download apps from *Store*.

### I can't find apps like Notepad and Paint! Where are they?

Swipe the right-hand edge of the screen inwards and tap **Search**, type the name of the app you would like to open using the pop-up keyboard. Alternatively, open *All apps* and scroll to 'Windows Accessories' to see the list of legacy programs.

## What is a Microsoft ID (account)?

A Microsoft account is an email address and password that you use to sign in to Windows. You can use any email address, but it is best if you choose the one you already use to communicate with friends and sign in to your favorite websites. When you sign in to your PC with a Microsoft account, you'll connect your PC to the people, files, and devices you care about.

### Do I need one?

You do not need a Microsoft ID to use Windows 8, but it makes life easier because you can sync data across different machines you sign in to using a Microsoft ID.

### How do I get one?

If you've already installed Windows 8 and didn't sign in with a Microsoft account or you don't have a Microsoft account and want to get one, swipe the right-hand edge of the screen inwards and tap **Settings** > **Change PC settings** > **Users** > **Switch to a Microsoft account**, and follow the onscreen instructions.

## How do I add a favorite to Internet Explorer?

Internet Explorer 10 doesn't have traditional favorites, instead you can pin shortcuts to *Start*. Once you have the page open, swipe upwards from the bottom edge of the screen to open the menu at the bottom of the screen. Tap **Pin to Start**.

## How do I check for Windows updates?

Swipe the right-hand edge of the screen inwards and tap **Settings** > **Change PC settings** > **Windows Updates**. Tap **Check for updates now**.

## Where can I get more information?

For more information please visit the following pages:

- Windows 8 tutorials: [www.acer.com/windows8-tutorial](http://www.acer.com/windows8-tutorial)
- Support FAQs: [www.acer.com/support](http://www.acer.com/support)



# Troubleshooting

This chapter shows you how to deal with common system problems. Read it before calling a technician if a problem occurs. Solutions to more serious problems require opening up the computer. Do not attempt to open the computer yourself; contact your dealer or authorized service center for assistance.

## Troubleshooting tips

This computer incorporates an advanced design that delivers onscreen error message reports to help you solve problems.

If the system reports an error message or an error symptom occurs, see "Error messages" below. If the problem cannot be resolved, contact your dealer. **See "Requesting service" on page 56.**

## Error messages

If you receive an error message, note the message and take the corrective action. The following table lists the error messages in alphabetical order together with the recommended course of action.

<b>Error messages</b>	<b>Corrective action</b>
CMOS battery bad	Contact your dealer or an authorized service center.
CMOS checksum error	Contact your dealer or an authorized service center.

<b>Error messages</b>	<b>Corrective action</b>
Disk boot failure	Insert a system (bootable) disk into an external drive, then press <Enter> to reboot.
Hard disk 0 error	Contact your dealer or an authorized service center.
Hard disk 0 extended type error	Contact your dealer or an authorized service center.
I/O parity error	Contact your dealer or an authorized service center.

If you still encounter problems after going through the corrective measures, please contact your dealer or an authorized service center for assistance.

# RECOVERING YOUR SYSTEM

---

Your computer comes with system recovery DVDs, but does not contain an optical disc drive (ODD). Obtain an external ODD and complete the following steps to recover your computer to factory conditions:

1. Shutdown the computer completely by pressing and holding the power button for more than 4 seconds or by tapping the **Settings charm > Change PC settings > General**. Under "Advanced startup", tap **Restart now**. The "Choose an option" screen displays. Tap **Turn off your PC**.
2. Connect the ODD to your computer.
3. Enter the computer's BIOS by pressing the Windows button and the power button at the same time.
4. Select the **Boot** option in the left pane.
5. Under "Boot priority order", move **EFI DVD/CDROM** to the number one position using the provided instructions.
6. Select **Exit** in the left pane and select **Exit Saving Changes** on the right side.
7. Insert the recovery DVD, turn on your computer, and follow the onscreen instructions.

# BIOS UTILITY

---

The BIOS utility is a hardware configuration program built into your computer's BIOS.

Your computer is already properly configured and optimized, and you do not need to run this utility. However, if you encounter configuration problems, you may need to run it.

To enter the BIOS utility, do the following:

- Ensure your computer is completely powered off (**See "Turning your computer on and off" on page 16**). Press and hold the Windows button and then press the Power button.

## Boot sequence

To set the boot sequence in the BIOS utility, activate the BIOS utility, then select the **Boot** option in the left pane. Under "Boot priority order", change the sequence as desired.

## Setting passwords

To set a password on boot, activate the BIOS utility, then select **Security** from the left pane. Under "Set Supervisor Password", select **Enter**. Enter your desired password and select **OK**. Under "Password on Boot:", set the option to **Enabled**.

# REGULATIONS AND SAFETY NOTICES

---

## FCC STATEMENT

This device has been tested and found to comply with the limits for a Class B digital device pursuant to Part 15 of the FCC rules. These limits are designed to provide reasonable protection against harmful interference in a residential installation. This device generates, uses, and can radiate radio frequency energy and, if not installed and used in accordance with the instructions, may cause harmful interference to radio communications.

However, there is no guarantee that interference will not occur in a particular installation. If this device does cause harmful interference to radio or television reception, which can be determined by turning the device off and on, the user is encouraged to try to correct the interference by one or more of the following measures:

- Reorient or relocate the receiving antenna.
- Increase the separation between the device and receiver.
- Connect the device into an outlet on a circuit different from that to which the receiver is connected.
- Consult the dealer or an experienced radio/television technician for help.

## **Notice: Shielded cables**

All connections to other computing devices must be made using shielded cables to maintain compliance with FCC regulations.

## NOTICE: PERIPHERAL DEVICES

Only peripherals (input/output devices, terminals, printers, etc.) certified to comply with the Class B limits may be attached to this equipment. Operation with non-certified peripherals is likely to result in interference to radio and TV reception.

**Caution: Changes or modifications not expressly approved by the manufacturer could void the user's authority, which is granted by the Federal Communications Commission, to operate this computer.**

#### **NOTICE FOR CANADA**

This Class B digital apparatus complies with Canadian ICES-003.

#### **Remarque à l'intention des utilisateurs canadiens**

Cet appareil numérique de la classe B est conforme à la norme NMB-003 du Canada.

#### **COMPLIANT WITH RUSSIAN REGULATORY CERTIFICATION**



**ME61**

#### **LCD PIXEL STATEMENT**

The LCD unit is produced with high-precision manufacturing techniques. Nevertheless, some pixels may occasionally misfire or appear as black or red dots. This has no effect on the recorded image and does not constitute a malfunction.

#### **RADIO DEVICE REGULATORY NOTICES**

**Note:** *Below regulatory information is for models with wireless LAN and / or Bluetooth only.*

To prevent radio interference to the licensed service, this device is intended to be operated indoors.

This product complies with the radio frequency and safety standards of any country or region in which it has been approved for wireless use. Depending on configurations, this product may or may not contain wireless radio devices (such as wireless LAN and/or Bluetooth modules). Below information is for products with such devices.

## Declaration of Conformity for EU countries

Hereby, Acer, declares that this computer is in compliance with the essential requirements and other relevant provisions of Directive 1999/5/EC.

## Wireless operation channels for different domains

N. America	2.412-2.462 GHz	Ch01 through Ch11
Japan	2.412-2.484 GHz	Ch01 through Ch14
Europe ETSI	2.412-2.472 GHz	Ch01 through Ch13

## France: Restricted wireless frequency bands

Some areas of France have a restricted frequency band. The worst case maximum authorized power indoors is:

- 10 mW for the entire 2.4 GHz band (2400 MHz - 2483.5 MHz)
- 100 mW for frequencies between 2446.5 MHz and 2483.5 MHz

**Note:** *Channels 10 through 13 inclusive operate in the band 2446.6 MHz to 2483.5 MHz.*

There are few possibilities for outdoor use: On private property or on the private property of public persons, use is subject to a preliminary authorization procedure by the Ministry of Defense, with maximum authorized power of 100 mW in the 2446.5 - 2483.5 MHz band. Use outdoors on public property is not permitted.

In the departments listed below, for the entire 2.4 GHz band:

- Maximum authorized power indoors is 100 mW
- Maximum authorized power outdoors is 10 mW

Departments in which the use of the 2400 - 2483.5 MHz band is permitted with an EIRP of less than 100 mW indoors and less than 10 mW outdoors:

01 Ain Orientales	25 Doubs	59 Nord	71 Saone et Loire
02 Aisne	26 Drome	60 Oise	75 Paris
03 Allier	32 Gers	61 Orne	82 Tarn et Garonne
05 Hautes Alpes	36 Indre	63 Puy Du Dome	84 Vaucluse
08 Ardennes	37 Indre et Loire	64 Pyrenees Atlantique	88 Vosges
09 Ariege	41 Loir et Cher	66 Pyrenees	89 Yonne
11 Aude	45 Loret	67 Bas Rhin	90 Territoire de Belfort
12 Aveyron	50 Manche	68 Haut Rhin	94 Val de Marne
16 Charente	55 Meuse	70 Haute Saone	
24 Dordogne	58 Nievre		

This requirement is likely to change over time, allowing you to use your wireless LAN card in more areas within France.

Please check with ART for the latest information ([www.art-telecom.fr](http://www.art-telecom.fr)).

**Note:** *Your WLAN Card transmits less than 100 mW, but more than 10 mW.*



## List of national codes

This equipment may be operated in the following countries:

Country	ISO 3166 2 letter code	Country	ISO 3166 2 letter code
Austria	AT	Malta	MT
Belgium	BE	Netherlands	NT
Cyprus	CY	Poland	PL
Czech Republic	CZ	Portugal	PT
Denmark	DK	Slovakia	SK
Estonia	EE	Slovenia	SL
Finland	FI	Spain	ES
France	FR	Sweden	SE
Germany	DE	United Kingdom	GB
Greece	GR	Iceland	IS
Hungary	HU	Liechtenstein	LI
Ireland	IE	Norway	NO
Italy	IT	Switzerland	CH
Latvia	LV	Bulgaria	BG
Lithuania	LT	Romania	RO
Luxembourg	LU	Turkey	TR

## **CANADA — LOW-POWER LICENSE-EXEMPT RADIO COMMUNICATION DEVICES (RSS-210)**

### **Exposure of humans to RF fields (RSS-102)**

The computer employs low gain integral antennas that do not emit RF field in excess of Health Canada limits for the general population; consult Safety Code 6, obtainable from Health Canada's website at [www.hc-sc.gc.ca/rpb](http://www.hc-sc.gc.ca/rpb).

This device complies with RSS210 of Industry Canada.

This Class B digital apparatus complies with Canadian ICES-003, Issue 4, and RSS-210, No 4 (Dec 2000) and No 5 (Nov 2001).

"To prevent radio interference to the licensed service, this device is intended to be operated indoors and away from windows to provide maximum shielding. Equipment (or its transmit antenna) that is installed outdoors is subject to licensing."

Cet appareil numérique de la classe B est conforme à la norme NMB-003, No. 4, et CNR-210, No 4 (Dec 2000) et No 5 (Nov 2001).

« Pour empêcher que cet appareil cause du brouillage au service faisant l'objet d'une licence, il doit être utilisé à l'intérieur et devrait être placé loin des fenêtres afin de fournir un écran de blindage maximal. Si le matériel (ou son antenne d'émission) est installé à l'extérieur, il doit faire l'objet d'une licence.

***Caution: When using IEEE 802.11a wireless LAN, this product is restricted to indoor use due to its operation in the 5.15- to 5.25-GHz frequency range. Industry Canada requires this product to be used indoors for the frequency range of 5.15 GHz to 5.25 GHz to reduce the potential for harmful interference to co-channel mobile satellite systems. High power radar is allocated as the primary user of the 5.25 to 5.35 GHz and 5.65 to 5.85-GHz bands. These radar stations can cause interference with and/or damage to this device.***

The maximum allowed antenna gain for use with this device is 6 dBi in order to comply with the E.I.R.P limit for the 5.25- to 5.35 and 5.725 to 5.85 GHz frequency range in point-to-point operation.