

Haier

Domestic Dishwasher
DW12-CBE7



NOTICE

Carefully read the instructions contained in this manual, as they provide important information which is essential to safe and proper installation, use and maintenance of the appliance.

CE This appliance complies with following EEC directives:

- 73/23/EEC of 19/02/73 (Low Voltage) and subsequent modifications;
- 89/336/EEC of 03/05/89 (Electromagnetic Compatibility) and subsequent modifications.
- Carefully dispose of the packing material.
- After removing the packing, check to make sure that the appliance is not damaged. If in doubt, contact a qualified professional.
- The dishwasher must only be used by adults for the washing of household dishes and cooking utensils.
- Fundamental rules to follow when using the appliance:
 - * Never touch the dishwasher when barefoot or with wet hands or feet;
 - * We discourage the use of extension cords and multiple sockets;

- * During installation, the power supply cord must not be excessively or dangerously bent or flattened;
- * If the appliance is not operating properly or maintenance must be performed, disconnect the appliance from the power supply.
 - Keep detergents out of the reach of children, who must also be kept away from the dishwasher when it is open.
 - This appliance cannot be installed outdoors, not even if the area in which it is installed is covered by a roof; it is also very dangerous to leave it exposed to the rain and elements.
 - Do not touch the heating element during or after a wash cycle.
 - Do not lean or sit on the door when it is open, as this could overturn the dishwasher.
 - If the appliance malfunctions, turn off water supply to the appliance and disconnect the plug from the wall socket. Then, consult the section entitled, "Troubleshooting". If you cannot resolve the problem, contact a service centre.
 - Only specialised personnel are authorised to make repairs.
 - Appliances which are no longer being used must be made inoperable by cutting the power supply cord and removing the door lock.

Close-up View (control panel)



- A ON-OFF Light
- B ON-OFF Button
- C "HALF LOAD" Button

- D Low salt indicator light
- E Low rinse aid indicator light
- F Cycle indicator light



- E Upper Rack
- F Top Spray Arm
- G Rack Height Adjustor
- H Lower Rack
- I Washing Filter
- J Salt Container Cap
- K Bottom Spray Arm
- L Detergent and Rinse Aid Dispenser
- V Third Sprayer

Technical characteristics

Width	60 cm
Depth	58 cm
Height	82 cm
Capacity	12 standard place settings
Mains water pressure	0.03-0.6MPa
Power voltage	220-240V~ 50Hz
Total absorber power	2150W

Salt

The hardness of the water varies from place to place. If hard water is used in the dishwasher, deposits will form on the dishes and utensils.

The appliance is equipped with a special softener that uses a salt specifically designed to eliminate lime and minerals from the water.

Loading the Salt into the Softener

Always use salt intended for use with dishwashers.

The salt container is located beneath the lower rack and should be filled as follows:

- Remove the lower rack and then unscrew and remove the cap from the salt container;
- If you are filling the container for the first time, fill it with water;
- Place the end of the funnel (supplied) into the hole and introduce about 2 kg of salt. It is normal for a small amount of water to come out of the salt container.
- Carefully screw the cap back on.

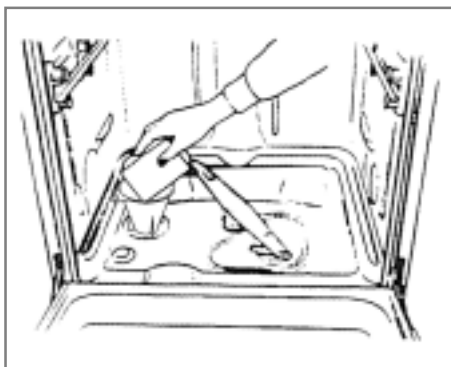

The salt container must be filled when the "low salt" indicator light (located on the control panel), comes on..

To prevent the formation of rust, load the salt just before beginning a wash cycle.

Adjusting Salt Consumption

The dishwasher is designed to allow for adjusting the amount of salt consumed based on the hardness of the water used. This is intended to optimize and customize the level of salt consumption so that it remains at a minimum.

To adjust salt consumption, proceed as follows:

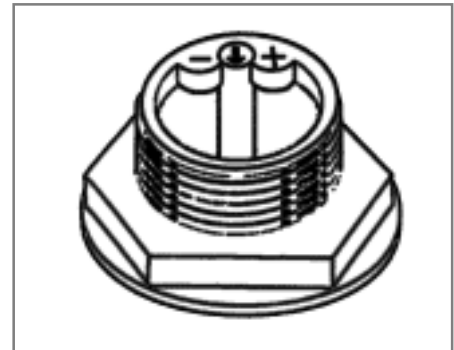

- Unscrew the cap from the salt container;
- There is a ring on the container with an arrow on it (see figure to the side),
- If necessary, rotate the ring in an anticlockwise direction from the "-" setting towards the "+" sign, based on the hardness of the water being used.

It is recommended that adjustments be made in accordance with the following schema:

Water Hardness					
Clarke degrees	°dH	mmol/l	Selector position	Salt consumption (Grams/cycle)	Autonomy (cycles/2kg)
0 ÷ 14	0 ÷ 17	0 ÷ 1,7	/	0	/
14 ÷ 36	18 ÷ 44	1,8 ÷ 4,4	"-"	20	60
36 ÷ 71	45 ÷ 89	4,5 ÷ 8,9	MED	40	40
>71	>89	>8,9	"+"	60	25

Detergent

Detergent specifically intended for use with dishwashers must be used. The dispenser must be refilled before the start of each wash cycle following the instructions provided in the "Wash Cycle Table". The detergent dispenser is located on the inside panel the door.

Loading the detergent

To open the "A" cover on the dispenser, press the "B" button. The detergent for the wash cycle should be poured into the "C" compartment.

After the detergent has been placed in the dispenser, close the cover and press down until it clicks in place.

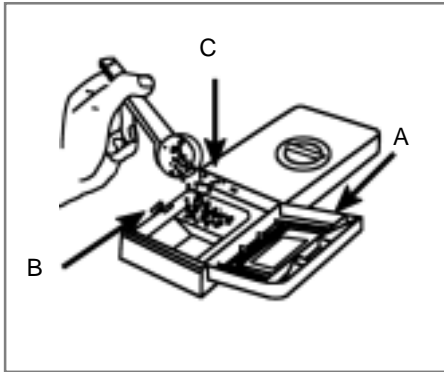

Notice: To facilitate closing the cover, remove any excess detergent on the edges of the dispenser.

Rinse Aid

This product makes dishes sparkle and helps them to dry without spotting. The dispenser is located on the inside panel of the door and should be filled after every 80 wash cycles (or when the "low rinse aid" indicator light comes on for those models with this feature).

Loading the Rinse Aid

Regardless of the type of detergent dispenser installed on your appliance, you must proceed as indicated below when loading the rinse aid.

To open the dispenser, turn the "C" cap in an anti-clockwise direction and then pour in the rinse aid, making sure not to overfill. The amount of rinse aid used for each cycle can be regulated by turning the "F" dose adjustor, located beneath the "C" cap, with a screwdriver. There are 6 different settings; the normal dosage setting is 3.

Important

Proper dosage of the rinse aid improves drying.

If drops of water remain on the dishes or spotting occurs, the dosage adjustor should be turned to a higher setting.

If the dishes have white streaks, turn the dosage adjustor to a lower setting.

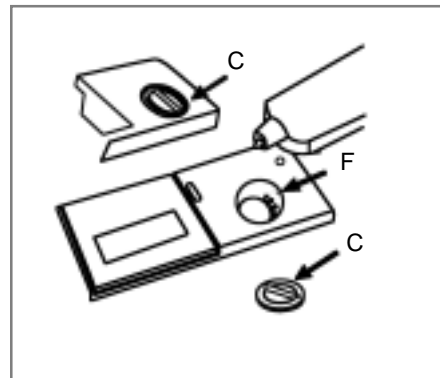

Before placing the dishes in the dishwasher, remove larger food particles to prevent the filter from becoming clogged, which results in reduced performance.

If the pots and pans have baked-on food that is extremely hard to remove, we recommend that they are soaked before washed. This will eliminate the need for extra wash cycles.

Pull out the rack to load the dishwasher.

How to use the lower rack

We recommend that you place the most difficult to clean items on the bottom rack: pots, pans, lids, serving dishes and bowls, as shown in the figure to the right.

It is preferable to place serving dishes and lids on the sides of the racks in order to avoid blocking the rotation of the top spray arm.

- Pots, serving bowls, etc. must always be placed face down.
- Deep pots should be slanted to allow the water to flow out.
- The lower rack features fold down tine rows (see fig.A) so that larger or more pots and pans can be loaded.
- The silverware basket can be doubled (see fig.B) so that only one section may be used when the silverware load is light. This also makes space for additional pots and pans and it can also be placed in the upper rack.
- Silverware should be placed in the silverware basket with the handles at the bottom; if the rack has side baskets, the spoons should be located individually into the appropriate slots. Especially long utensils should be placed in the horizontal position at the front of the upper rack.

How to use the upper rack

The upper rack is designed to hold more delicate and lighter dishware, such as glasses, cups and saucers, plates, small bowls and shallow pans (as long as they are not too dirty).

- Position the dishes and cookware so that they do not get moved by the spray of water.

The upper rack can be adjusted for height by using the knobs located on the sides of the rack itself (see fig.C).

Shelf

Lean tall glasses and those with long stems against the shelf-not against other items to be washed.

Place glasses, cups and small bowls on the additional cup rack. The additional cup rack can be swivelled in or out as required (see fig.D).

Lower Rack

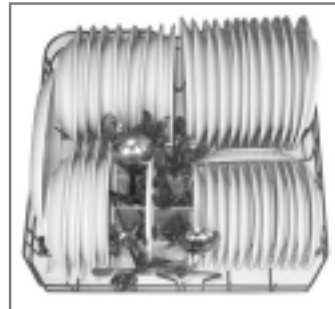

Upper Rack

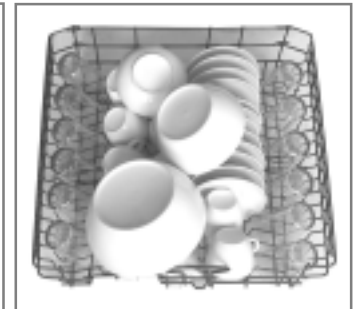

Load for 12 Standard Settings

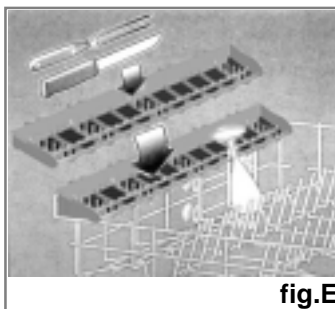
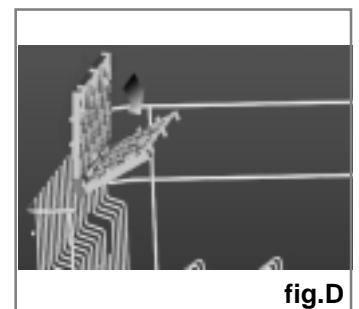
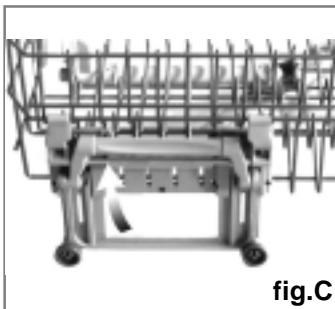
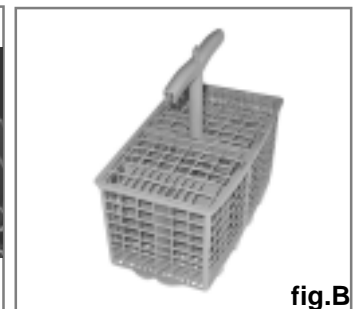
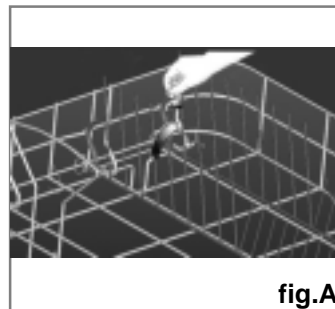

Starting a wash cycle...

After having completed all of the installation steps in the preceding paragraphs, turn on the water to the unit, partially open the door of the dishwasher, and press the ON-OFF button "A" located on the control panel. The "B" indicator light will come on. At this point, the appliance is on and ready to be programmed.

Setting and Starting a wash Cycle

Choose the desired cycle by pressing the cycle selection button "P". Each time it is pressed, one of the cycle indicator lights "M" will come on in succession.

Choose the wash cycle you feel is most appropriate for the type of dishes that need washing (consult the wash cycle table contained in this manual, especially when first using the appliance). Close the door and after a few seconds, a short acoustic signal will sound indicating that the wash cycle has begun and cannot be modified. If necessary, read the paragraph entitled, "Cancelling or modifying a cycle while underway". The end of the cycle will be signalled by a double acoustic sound, and the indicator light "M" will begin to blink.

Cancelling or modifying a cycle while underway...

Premise: A cycle that is underway can only be modified if it has only been running for a short time.

Otherwise, the detergent may have already been used, and the appliance may have already drained the wash water. If this is the case, the detergent dispenser must be refilled (see the paragraph entitled, "Loading the Detergent").

To change the cycle currently underway, open the door, press the "P" programming button and hold it in for about 5 seconds. Once the cycle has been cancelled, the dishwasher will emit a short acoustic sound and the relative indicator light will turn off.

To set a new wash cycle, follow the instructions contained in the paragraph entitled, "Setting and Starting a Wash Cycle".

If you forget to load some of the dishes...

The wash cycle can be interrupted by opening the door carefully (in order to avoid being sprayed by hot water). When the door is closed again, the cycle will automatically restart at the point where it left off.

At the end of the wash cycle...

The end of the cycle will be indicated by a double acoustical signal and the blinking of the "M" indicator light. Open the door, turn off the appliance using the ON-OFF switch and turn off the water supply to the unit. Wait a few minutes before removing the dishes so as to avoid handling them while still hot (when they are more susceptible to breakage) and to get better drying results.

Setting The Start Delay Time

Open the door of the dishwasher partially. If the "C" button is pressed (see, Close-up View "Control Panel"). The start time for the wash cycle can be delayed for 2,4 or 6 hours.

Each time the button is pressed, the "D" light will come on indicating the length of the delay.

After selecting the delay time, the wash cycle can be set, as explained in "Starting a wash cycle..." There will be a short acoustic signal, and at this point the delay period will begin to count down. During this period the delay indicator light (D) will blink. At the end of the delay time, the indicator will stop blinking and the cycle will start.

NOTE:

- a) During the delay period, none of the settings can be modified. If necessary, they can be cancelled by pressing cycle selector "P" for about 5 seconds.
- b) If the power to the appliance goes off or the door is opened during the delay period, the clock will stop the countdown. It will start again when the power has come back on, or when the door has been closed.

Wash Cycle Adjustment Buttons







1/2 Load Button

This button (see "Close-up View-Control Panel", letter "Q") makes it possible to wash dishes using only the upper rack if there are not enough dishes for a full load, This will allow you to save on water and electrical energy.

It cannot be used with the heavy duty wash cycles.

Wash Cycle Table



-It is important to try and run the dishwasher when it is fully loaded in order to save on energy. In order to prevent odors from forming and food from caking onto the dishes, you can run the hold cycle.

-Choose the right wash cycle: the choice of cycle depends on the type of dishware, cookware and utensils being washed and how dirty they are.

-Use the right amount of detergent: if you use too much detergent, the result will not be cleaner dishes, but, rather, a greater negative impact on the environment.

-There is no advantage in rinsing dishes, cookware and utensils before placing them in the dishwasher.

How to keep Your Dishwasher in Shape

After Every Wash

After every wash, turn off the water supply to the appliance and leave the door slightly ajar so that moisture and odors are not trapped inside.

Remove the plug

Before cleaning or performing maintenance, always remove the plug from the socket. Do not run risks.

No solvents or Abrasive Cleaning Products

To clean the exterior and rubber parts of the dishwasher, do not use solvents or abrasive cleaning products. Rather, use only a cloth and warm soapy water.

To remove spots or stains from the surface of the interior, use a cloth dampened with water and a little white vinegar, or cleaning product made specifically for dishwashers.

When You Go on Holiday

When you go on holiday, it is recommended that you run a wash cycle with the dishwasher empty and then remove the plug from the socket, turn off the water supply and leave the door of the appliance slightly ajar. This will help the seals last longer and prevent odors from forming within the appliance.

Moving the Appliance

If the appliance must be moved, try to keep it in a vertical position. If absolutely necessary, it can be positioned on its back.

Seals

One of the factors that cause odors to form in the dishwasher is food that remains trapped in the seals. Periodic cleaning with a damp sponge will prevent this from occurring.

Cleaning and Special Maintenance

Filter Assembly

For best performance and results, the filter assembly must be cleaned frequently.

The filter efficiently removes food residue from the wash water, allowing it to be recirculated during the cycle. For this reason, it is a good idea to remove the larger food particles trapped in the filter after each wash cycle by rinsing the "A" semi-circular filter and cup under running water. To remove the filter assembly, pull on the cup handle in the upward direction. The entire filter assembly (made up of the "A" semicircular filter and the "B" fine filter) should be cleaned at least once a month.

To clean the filter and the fine filter, use a cleaning brush. Then, reassemble the filter parts as shown in the figures below and reinsert the entire assembly in the dishwasher, positioning in its seat and pressing downward.

The dishwasher must never be used without the filters. Improper replacement of the filters may reduce level of the appliance and damage dishes and utensils.



Cleaning the Spray Arms

It may happen that food particle become encrusted on the spray arms and block the holes. Check the spray arms periodically and clean them when needed.

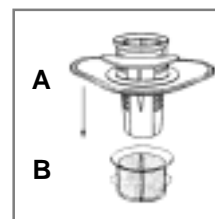

Cleaning the Water Inlet Filter

Periodically clean the water inlet filter (see figure) located on the outlet of the water supply tap.

After turning off the water tap, unscrew the end of the water supply hose, remove the filter and clean it carefully under running water. Then, return the filter to its place and tighten the water supply hose back into position.

It may occur that the dishwasher does not function or does not function properly. Before calling for assistance, let us see what can be done first: have you forgotten to press one of the buttons or to perform an essential operation?

The Dishwasher Does Not Start

Have you checked whether:

- the plug is pushed into the socket correctly;
- the power is on in the house;
- the door is closed properly;
- the ON-OFF switch is on "ON";
- the water supply is turned on.

The Dishwasher Does Not Load Water

Have you checked whether:

- the water is turned on and the hose is connected properly;
- the water supply to the house is on and has sufficient pressure;
- the water supply hose is crimped or bent;
- the filter for the water supply hose is clogged.

The Dishes Are Not Clean

Have you checked whether:

- the water is turned on and the hose is connected properly;
- the water supply to the house is on and has sufficient pressure;
- the water supply hose is crimped or bent;
- the filter for the water supply hose is clogged.

The Dishwasher Does Not Drain

Have you checked whether:

- the drain hose is crimped or bent.

Lime Deposits or a White Film Form on the Dishes

Have you checked whether:

- the lid to the salt container is closed properly;
- the rinse aid dosage is correct.

Error Messages

The dishwasher is equipped with a safety system that is able to detect operating problems and malfunctions. These malfunctions are signalled by the rapid blinking of one of the "M" program LEDs. Only in the case where the indicator light for the soak cycle (see table for cycles) blinks rapidly should you cancel the cycle as described in the section entitled, "Changing a Cycle while Underway". Then check to make sure that there is water in the mains and that the tap is turned on. If the message continues, call for technical assistance, indicating which message appeared. If any of the other indicator lights begins to blink rapidly, turn off the appliance and call for technical assistance, indicating which light began to blink.

If, despite all these checks, the dishwasher still does not function and/or the problem persists, contact the nearest authorised service centre and provide them with the following information:

- the nature of the problem;
- the model type number (Mod...) And the serial number (S/N...), which are indicated on the plate located on the side of the inner part of the door.

Never call on unauthorised technicians and refuse to allow parts to be installed that are not original spare parts.

Positioning the Appliance

Positioning the appliance in the desired location. The back should rest against the wall behind it, and the sides, along the adjacent cabinets or wall. The dishwasher is equipped with water supply and drain hoses that can be positioned to the right or the left to facilitate proper installation.

Levelling the Appliance

Once the appliance is positioned, adjust the feet (screwing them in or out) to adjust the dishwasher, making it level. In any case, the appliance should not be inclined more than 2°. If the appliance is level, it will help ensure proper performance.

Cold Water Connection

Connect the cold water supply hose to a threaded 3/4 (gas) connector, making sure that it is fastened tightly in place (see fig.2). Some models are fitted with an "Aquastop" water supply hose (see fig.1) in which the small filter is already housed in the threaded end.

If the water pipes are new or have not been used for an extended period of time, let the water run to make sure that the water is clear and free of impurities. If this precaution is not taken, there is a risk that the water inlet can get blocked and damage the appliance.

Hot Water Connection

The water supply to the appliance can also be connected to the house's hot water line (centralised system, heating system), as long as it does not exceed a temperature of 60°C .

In this case, the wash cycle time will be shortened by about 15 minutes and the wash efficiency slightly reduced.

The connection must be made to the hot water line following the same procedures as those for the connection to the cold water line.

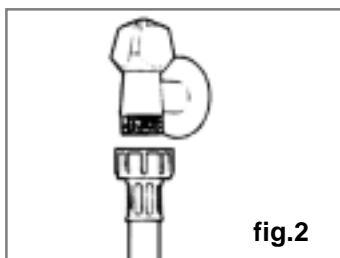

Anti-Flooding Protection

The dishwasher is equipped with a system that stops the supply of water in the event of a problem with the water supply hose, or leaks within the unit, in order to prevent damage to your home. If for any reason the box containing the electrical components happens to get damaged, remove the plug for the appliance from the socket immediately. In order to guarantee that the anti-flooding feature operates properly, the "A" box with water supply hose must be attached to the water supply tap as shown in Fig .1. No other type of connection is acceptable.

The water supply hose must not, under any circumstances, be cut, as it contains electrical parts which are live. If the length of the hose is not adequate to make a proper connection, the hose must be replaced with one which is long enough. This hose is available upon request from specialised retailers and service centres.

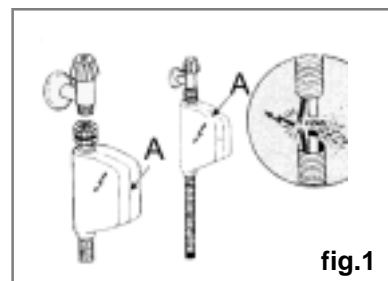

Drain Hose Connection

Insert the drain hose into a drain pipe with a minimum diameter of 4cm, or let it run into the sink, making sure to avoid bending or crimping it. Use the special plastic support that comes with the appliance (see fig.3). The free end of the hose must be at a height between 40 and 100 cm and must not be immersed in water.

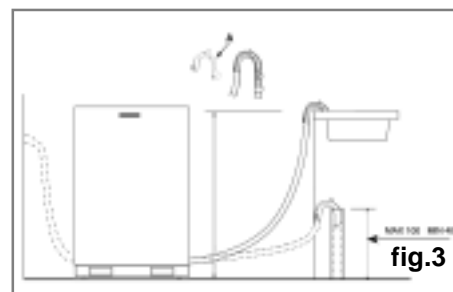

Attention:

The special plastic hose support must be solidly fastened to the wall to prevent the drain hose from moving and allowing water to spill outside the drain.

Electrical Connection

After making sure that the voltage and frequency values for the current in the home correspond to those on the rating plate (located on the stainless steel inner door of the appliance) and that the electrical system is correct for the maximum voltage on the rating plate, insert the plug into an electrical socket which is earthed properly (the earthing of the appliance is a safety requirement mandated by law).

If the electrical socket to which the appliance must be connected is not appropriate for the plug, replace the plug, rather than using adaptors or the like as they could cause overheating and burns.

Caution:

The dishwasher plug must be accessible even when the appliance is installed as a built-in unit so that maintenance can be done safely.

Installation

