

**TEC**

TEC Digital Scale

**SL-47-N-1 SERIES**

**Owner's Manual**

Document No. EM1-31061A

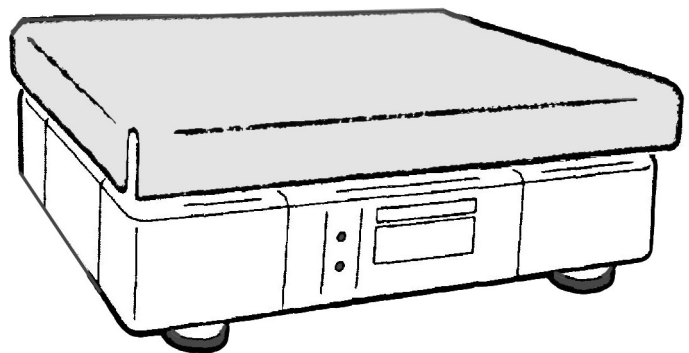

**TEC CORPORATION**

## TABLE OF CONTENTS

	Page
1. INTRODUCTION .....	1- 1
2. APPLICABLE MODEL .....	2- 1
3. SPECIFICATIONS .....	3- 1
4. OVERVIEW .....	4- 1
5. LEVEL ADJUSTMENT .....	5- 1
6. INSTALLING THE REMOTE PIPE .....	5- 1
7. CONNECTING THE INTERFACE CABLE AND REMOTE CABLES .....	7- 1
8. TROUBLESHOOTING .....	8- 1
9. BEFORE YOU CALL FOR SERVICE .....	8- 1

### **CAUTION:**

1. *This manual may not be copied in whole or in part without prior written permission of TEC.*
2. *The contents of this manual may be changed without notification.*
3. *Please refer to your local Authorized Service representative with regard to any queries you may have in this manual.*

# 1. INTRODUCTION

We thank you very much for purchasing the TEC Digital Scale SL47-N-1 Series. This series has been designed with TEC reliability.

Should you have any questions concerning the scale, please refer to this manual. Be sure to keep this manual for future reference.

This equipment has been tested and found to comply with the limits for a Class A digital device, pursuant to Part 15 of the FCC Rules. These limits are designed to provide reasonable protection against harmful interference when the equipment is operated in a commercial environment. This equipment generates, uses, and can radiate radio frequency energy and, if not installed and used in accordance with the instruction manual, may cause harmful interference to radio communications. Operations of this equipment in a residential area is likely to cause harmful interference in which case the user will be required to correct the interference at his own expense. (for USA only)

Changes or modifications not expressly approved by manufacturer for compliance could void the user's authority to operate the equipment.

"This Class A digital apparatus meets all requirements of the Canadian Interference-Causing Equipment Regulations."

"Cet appareil numérique de la classe A respecte toutes les exigences du Règlement sur le matériel brouilleur du Canada." (for CANADA only)

## **WARNING**

*This is a Class A product. In a domestic environment this product may cause radio interference in which case the user may be required to take adequate measures.*

As the colours of the cores in the mains lead of this equipment may not correspond with the colour markings identifying the terminals in your plug, proceed as follows:

- the core which is coloured green and yellow must be connected to the terminal in the plug which is marked with the letter E or by the earth symbol, or colored green and yellow,
- the core which is coloured blue must be connected to the terminal which is marked with the letter N or coloured black.
- the core which is coloured brown must be connected to the terminal which is marked with the letter L or coloured red.

**WARNING:** *This equipment must be earthed.*

## **Safety Summary**

Personal safety in handling or maintaining the equipment is extremely important. Warnings and Cautions necessary for safe handling are included in this manual. All warnings and cautions contained in this manual and written inside or outside of the scale should be read and understood before handling or maintaining the equipment.

Do not attempt to effect repairs to this equipment. If a fault occurs that cannot be rectified using the procedures described in this manual, turn off the power, unplug the machine, then contact your authorised TEC representative for assistance.

### Safety Precautions

This Owner's Manual and the products (machines) which you have purchased contain indications which should be observed in order to use the machines safely and prevent harm to yourself and others and damage to property. The meanings of these indications and symbols are given below. Read these indications and become familiar with their contents before reading this Owner's Manual.

The following safety precaution will help to ensure proper use of the scale.

- Unplug the printer whenever you are working inside the scale.
- Keep your work environment static free.

### Meanings of Each Symbol



This symbol indicates warning items (including cautions). Specific warning contents are drawn inside the  $\Delta$  symbol. (The symbol on the left indicates a general caution.)



This symbol indicates prohibited actions (prohibited items). Specific prohibited contents are drawn inside or near the  $\odot$  symbol. (The symbol on the left indicates "no disassembling".)



This symbol indicates actions which must be performed. Specific instructions are drawn inside or near the  $\bullet$  symbol. (The symbol on the left indicates "disconnect the power cord plug from the outlet".)



### WARNING

This indicates that there is the risk of death or serious injury if the machines are improperly handled contrary to this indication.



Prohibited



■ Do not plug in or unplug the power cord plug with wet hands as this may cause **electric shock**.



Any other than the specified AC voltage is prohibited.

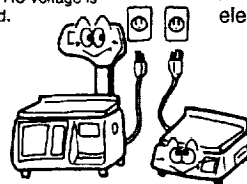

■ Do not use voltages other than the voltage (AC) specified on the rating plate, as this may cause fire or electric shock.



Prohibited

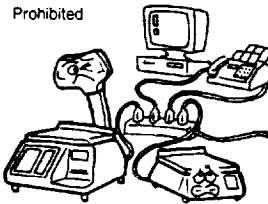

■ If the machines share the same outlet with any other electrical appliances which consume large amounts of power, the voltage will fluctuate widely each time these appliances operate. Be sure to provide an exclusive outlet for the machine as this may cause the machines to **malfunction**.



Prohibited

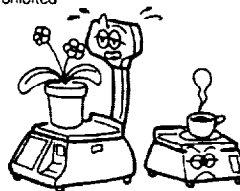

■ Do not place metal objects or water-filled containers such as flower vases, flower pots or mugs, etc. on top of the machines. If metal objects or spilled liquid enter the machines, this may cause **fire or electric shock**.



Prohibited



■ Do not insert or drop metal, flammable or other foreign objects into the machines through the ventilation slits, as this may cause **fire or electric shock**.















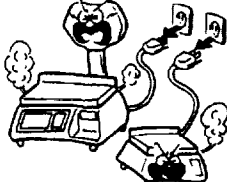



No disassembling.

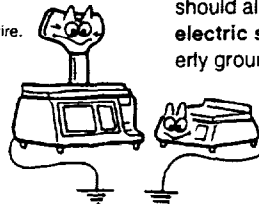

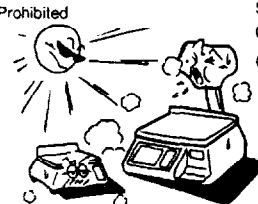

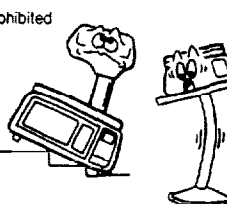

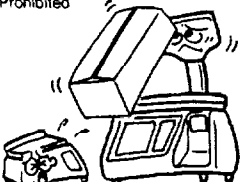

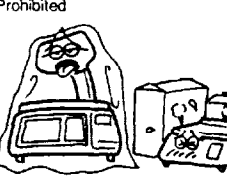

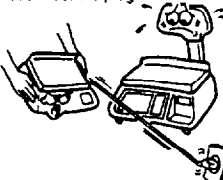
■ Do not remove covers, repair or modify the machine by yourself. You may be **injured** by high voltage, very hot parts or sharp edges inside the machine.

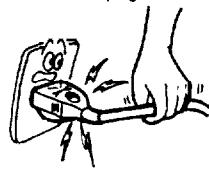
1. INTRODUCTION

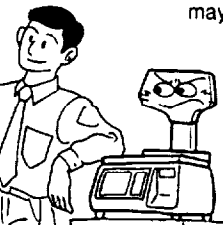
1. INTRODUCTION

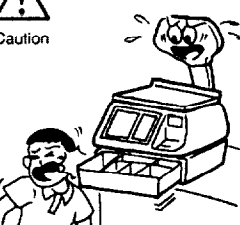
<p> Prohibited</p> 	<p>■ Do not scratch, damage or modify the power cords. Also, do not place heavy objects on, pull on, or excessively bend the cords, as this may cause fire or electrical shock.</p>	<p> Disconnect the plug.</p> 	<p>■ Continued use of the machines in an abnormal condition such as when the machines are producing smoke or strange smells may cause fire or electric shock. In these cases, immediately turn off the power switches and disconnect the power cord plugs from the outlet. Then, contact your sales agent (or maintenance and service agent).</p>
<p> Disconnect the plug.</p> 	<p>■ If foreign objects (metal fragments, water, liquids) enter the machines, first turn off the power switches and disconnect the power cord plugs from the outlet, and the contact your sales agent (or maintenance and service agent). Continued use of the machine in that condition may cause fire or electric shock.</p>	<p> Disconnect the plug.</p> 	<p>■ If the machines are dropped or their cabinets damaged, first turn off the power switches and disconnect the power cord plugs from the outlet, and the contact your sales agent (or maintenance and service agent). Continued use of the machine in that condition may cause fire or electric shock.</p>
<p> Connect a grounding wire.</p> 	<p>■ Ensure that the equipment is properly grounded. Extension cables should also be grounded. Fire or electric shock can occur on improperly grounded equipment.</p>		
<p> <b>CAUTION</b> This indicates that there is the risk of personal injury or damage to objects if the machines are improperly handled contrary to this indication.</p>			
<p> Prohibited</p> 	<p>■ Do not install the machines where they might be exposed to direct sunlight, high humidity, or dust. Otherwise fire or electric shock could occur.</p>	<p> Prohibited</p> 	<p><b>[Precautions During Installation]</b></p> <p>■ Do not place the machines on unstable or slanted surfaces, as they may drop or fall and cause injury.</p>
<p> Prohibited</p> 	<p>■ Do not place heavy objects on top of the machines, as these items may become unbalanced and fall causing injury.</p>	<p> Prohibited</p> 	<p>■ Do not block the ventilation slits of the machines, as this will cause heat to build up inside the machines and may cause fire.</p>

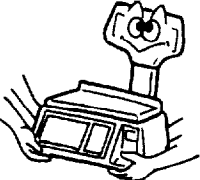
 <p>Disconnect the plug.</p>  <p><b>[Precautions When Moving the Machines]</b>          ■ When moving the machines, be sure to first unplug the power cords. Moving the machines with the power cords plugged in may damage the cords and cause fire or electric shock.</p>	 <p>Disconnect the plug.</p>  <p>■ When unplugging the power cords, be sure to hold and pull on the plug portion. Pulling on the cord portion may cut or expose the internal wires and cause fire or electric shock.</p>
 <p>Caution</p>  <p>■ Do not lean against the machine. It may fall and be damaged.</p>	 <p>Caution</p>  <p>■ When opening the cash drawer, be careful not to let the drawer hit children's heads, etc., as this may cause injury.</p>
 <p>Caution</p>  <p>■ Be sure to move large scale machines with two or more people. In addition, machines should be moved after first confirming that connecting wires between machines and externally connected wires, etc. have been removed. Failure to observe these precautions may result in injury.</p>	

**Precaution**

The following precautions will help to ensure that this machine will continue to function correctly.

- ① Try to avoid locations that have the following adverse conditions:
  - \* Temperatures below 0°C and above 40°C
  - \* Direct sunlight
  - \* Shared power socket
  - \* Excessive vibration
- ② Do not subject the weighing platter to sudden shocks.
- ③ Do not press the keys too hard. Keys will operate correctly if they are touched lightly.
- ④ Clean the cover and weighing platter by wiping with a dry cloth or a cloth soaked with detergent and wrung out thoroughly. Never use thinner or other volatile solvent for cleaning.
- ⑤ To ensure that the scale is operating correctly, place a known weight on the platter and check it for correct weight measurement. This should be done every morning before starting normal operations.
- ⑥ At the end of the day, turn the power OFF, then clean and inspect the exterior of the scale.
- ⑦ Try to avoid using this equipment on the same power supply as high voltage equipment or equipment likely to cause mains interference (freezer cabinets etc.).
- ⑧ USE ONLY TEC SPECIFIED media.
- ⑨ **DO NOT STORE** the media where they might be exposed to direct sunlight, high temperatures, high humidity, dust, or gas.
- ⑩ When moving the scale, take hold of the case and lift the scale. Never hold the remote unit.

## 2. APPLICABLE MODEL

### Model name description

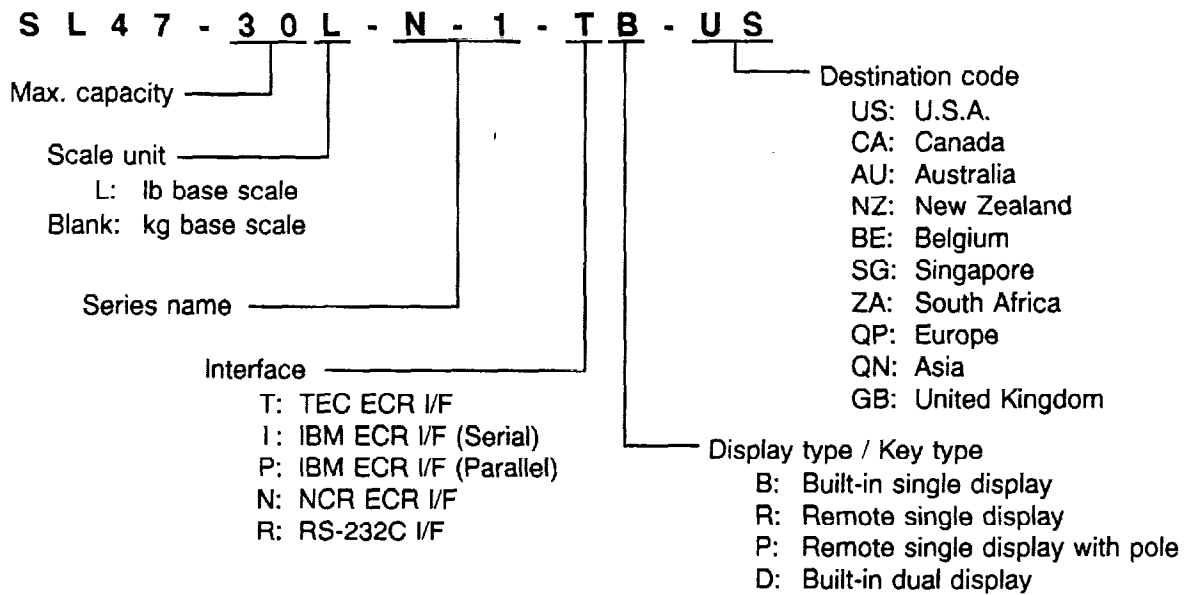

## 3. SPECIFICATIONS

## 3. SPECIFICATIONS

## 3. SPECIFICATIONS

Item	SL47-30L-N-1-US	SL47-50L-N-1-US
Maximum Capacity	30 lbs.	50 lbs.
Minimum Scale Division	0.01 lb	0.01 lb.
Display Range	0~30.05 lbs.	0~50.05 lbs.
Display (Weight)	4 digits	
Power Requirement	AC 120V $\pm$ 10%, 60 Hz	
Current Consumption	120V, 0.2A	
Operating Temperature	32°F ~ 104°F	
Relative Humidity	45% ~ 85% RH (no condensation)	
Dimensions (approx.)		
Built-in Type	13.58" (W) $\times$ 12.06" (D) $\times$ 4.61" (H)	
Remote Display Type	16.54" (W) $\times$ 12.06" (D) $\times$ 4.13" (H)	
Display unit	6.3" (W) $\times$ 4.72" (D) $\times$ 4.49" or 19.29" (H)	
Weight (approx.)	15.8 lbs.	
Interface	① TEC ECR                      ④ NCR ECR ② IBM ECR (Serial)        ⑤ RS-232C ③ IBM ECR (Parallel)	

Item	CA/AU/NZ/BE/SG/ZA/QP/QN	GB
Maximum Capacity	15 kg	30 lbs.
Minimum Scale Division	0.005 kg	0.01 lb
Display Range	0~15.025 kg	0~30.05 lbs.
Display (Weight)	5 digits	4 digits
Power Requirement	* See Table 1.	
Current Consumption	* See Table 1.	
Operating Temperature	0°C ~ 40°C	
Relative Humidity	45% ~ 85% RH (no condensation)	
Dimensions (approx.)		
Built-in Type	344.9 (W) $\times$ 306.4 (D) $\times$ 117 (H) mm	
Remote Display Type	344.9 (W) $\times$ 306.4 (D) $\times$ 105 (H) mm	
Display unit	160 (W) $\times$ 120 (D) $\times$ 114 or 490 (H) mm	
Weight (approx.)	8 kg	
Interface	① TEC ECR                      ④ NCR ECR ② IBM ECR (Serial)        ⑤ RS-232C ③ IBM ECR (Parallel)	
(Connectable interface cable differs according to model.)		

Table 1

	Power Requirement
	Current Consumption
CA	120V $\pm$ 10%, 60Hz
	120V, 0.2A
AU/NZ	240V $\pm$ 10%, 50Hz
	7W
BE	220V $\pm$ 10%, 50Hz
	7W
SG	220V $\pm$ 10%, 50/60Hz
	220V, 0.1A
ZA	220V $\pm$ 10%, 50Hz
	7W
QP/GB	230V $\pm$ 10%, 50Hz
	230V, 0.1A, 7W
QN	220V $\pm$ 10%, 50/60Hz
	220V, 0.1A, 7W

### ■ Dimensions of platter (approx.)

Platter	Dimensions	
	W	D
Vegetable platter	13.58" (344.9 mm)	12.06" (306.4 mm)
Flat platter (small)	13.58" (344.9 mm)	12.06" (306.4 mm)
Flat platter (large)	16.54" (420 mm)	12.06" (306.4 mm)



## 4. OVERVIEW

*NOTE: The appearance of the scale (platter, level gauge, display, etc.) varies according to model.*

- Built-in Type

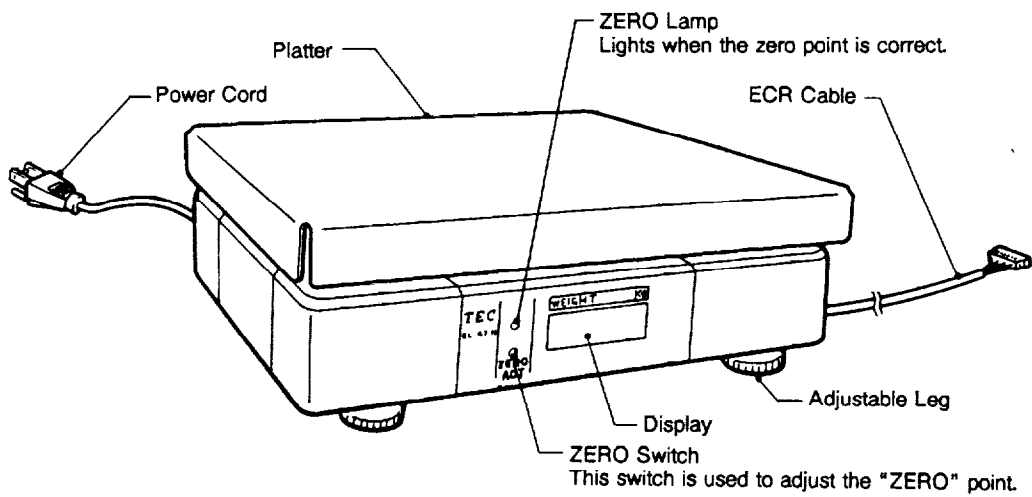

- Remote Display Type

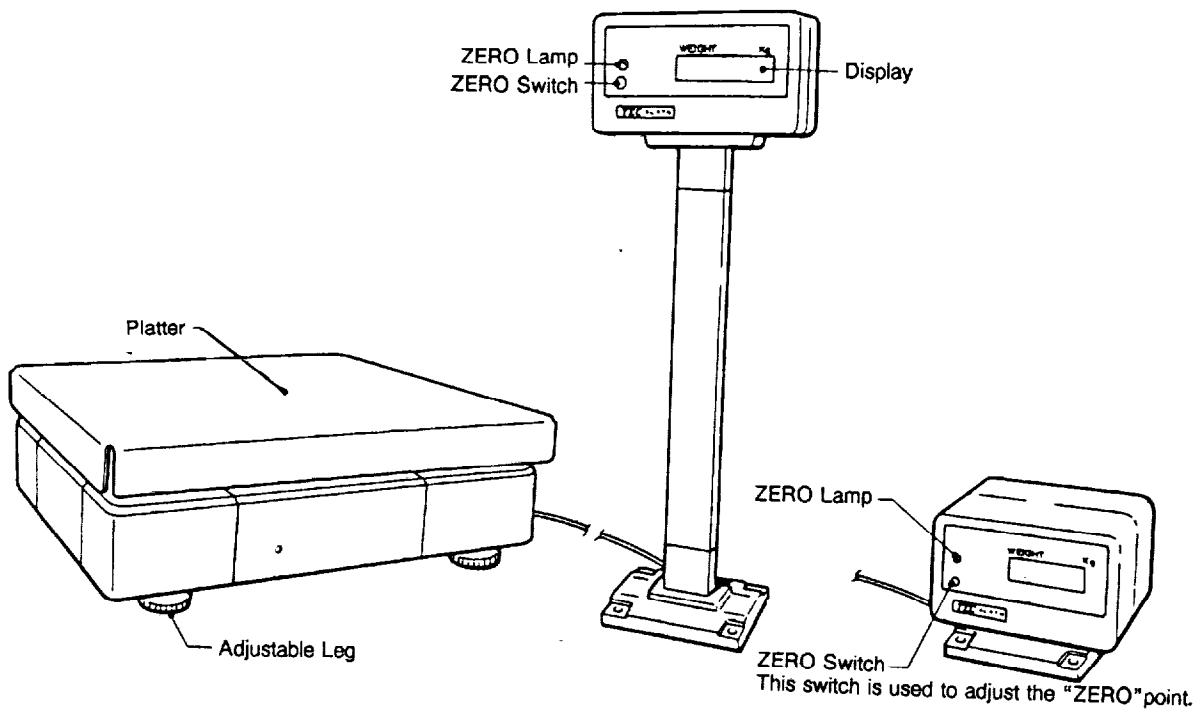

## 5. LEVEL ADJUSTMENT

## 5. LEVEL ADJUSTMENT

## 5. LEVEL ADJUSTMENT

Set the scale on a stable and level surface. Level the scale by turning the adjustable legs so that the air bubble is inside the center circle.

**NOTE:** The attached position of the level gauge differs according to model.

Level Gauge

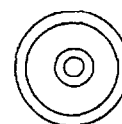

Correct

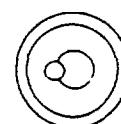

Incorrect

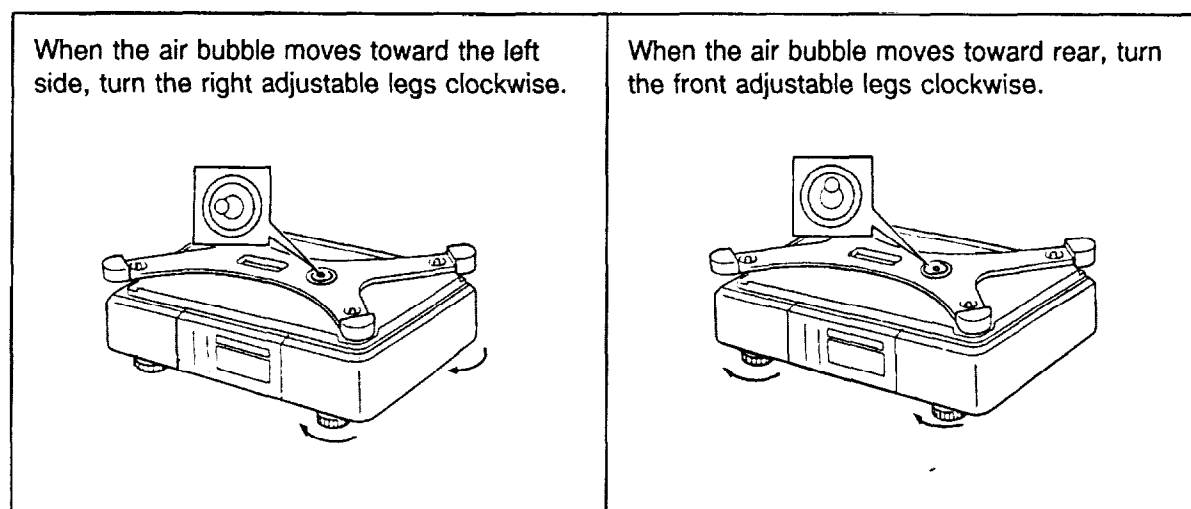

## 6. INSTALLING THE REMOTE PIPE

(for remote display type with pipe only)

1. Remove the clamp and detach the remote display from the remote stand.

**NOTE:** Be careful NOT TO LOSE the clamp, screws Ⓐ (FL-4 × 25), and screw Ⓑ (FL-4 × 8).

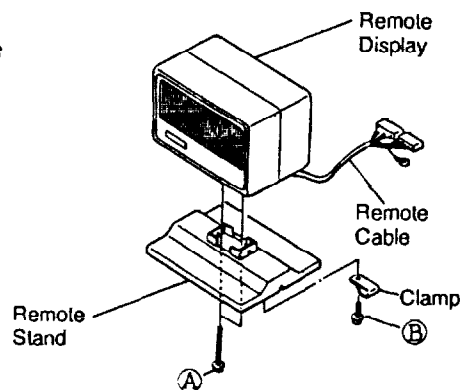

## 6. INSTALLING THE REMOTE PIPE

## 6. INSTALLING THE REMOTE PIPE

2. Attach the joined plate to the remote display using screws ③ (FL-4 × 6).
3. Pass the remote cable through the remote pipe.
4. Attach the remote pipe to the joined plate using screws ④ (B-4 × 4).

**NOTE:** The joined plate, remote pipe, screws ③, and ④ are supplied with the scale.

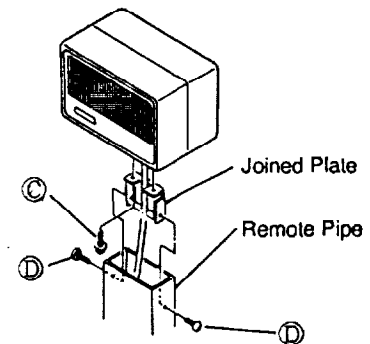

5. Pass the remote cable through the remote stand.
6. Attach the pipe support plate to the remote stand using screws ⑤.

**NOTE:** The pipe support plate is supplied with the scale.

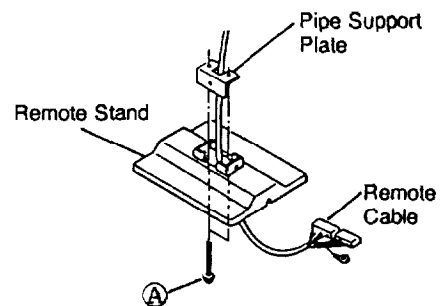

7. Attach the remote pipe to the remote stand using screws ⑥.
8. Fix the remote cable to the remote stand using clamp and screw ⑦. There are two cable outlets which should be used according to the usage.

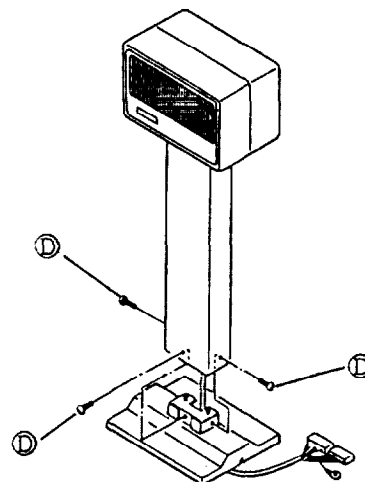
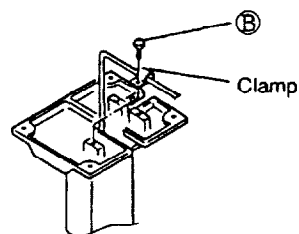

## 7. CONNECTING THE INTERFACE CABLE AND REMOTE CABLES

## 7. CONNECTING THE INTERFACE CABLE AND REMOTE CABLES

7. CONNECTING THE INTERFACE CABLE AND  
REMOTE CABLES

**WARNING:** Disconnect the power cord before connecting the cables.

1. Remove the blind plate (right side).

**NOTE:** Be careful NOT TO LOSE the screw ⑤ (M-4 × 10).

2. Connect the interface cable cable to the connector on the CPU board.
3. Fix the interface cable cable to the base using the clamp and screw ⑥ (FL-4 × 14).
4. For remote display type, connect the remote cable to the connectors on the CPU board.
5. Fix the remote cable to the base using the clamp and screw ⑥.
6. Attach the blind plate using screw ⑤.

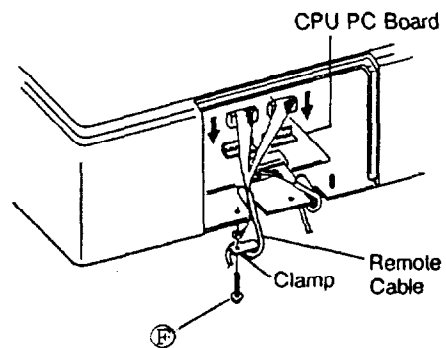
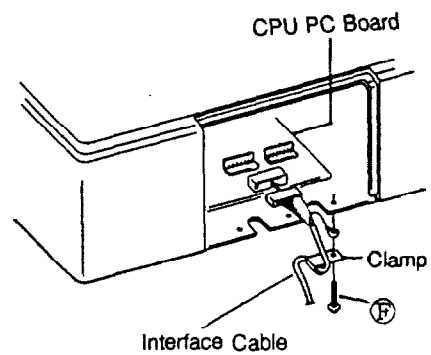
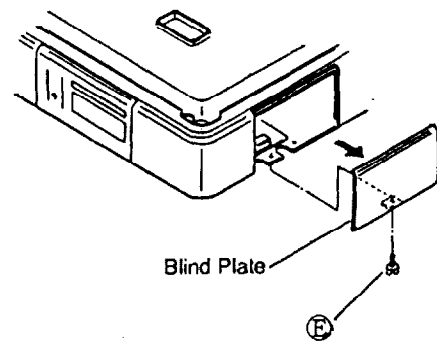

## 8. TROUBLESHOOTING

## 8. TROUBLESHOOTING

## 8. TROUBLESHOOTING

Problems	Solution
"-----" is displayed at power on.	<ul style="list-style-type: none"> <li>• Was the power turned ON when something was on the platter? → Make sure nothing is on the platter and turn the power on again.</li> <li>• Is the platter mounted correctly? → Mount the platter correctly and turn the power on again.</li> </ul>
Display is not stable.	<ul style="list-style-type: none"> <li>• Is anything touching the platter? → If so, remove it.</li> <li>• Does wind blow into the room from the outside? → Avoid locations subject to the wind.</li> </ul>

## 9. BEFORE YOU CALL FOR SERVICE

It is our primary concern to give you full satisfaction and better service. If, however, any problem arises in connection with the operation of this scale, please check the following points before calling for service.

- Is the power plug fully plugged into an AC outlet?
- Is AC power being properly supplied to the outlet? (Check it using another electric appliance.)
- Check the circuit breaker.
- Has there been a power failure of any sort?

**WARNING:**

*This scale has been manufactured under strict quality control. If you have trouble, however, DO NOT ATTEMPT TO FIX BY YOURSELF. Pull the power plug out of the AC outlet, and contact your TEC representative.*



**TEC**  
TEC CORPORATION

英文  
E PRINTED IN JAPAN  
EM1-31061A 97061000 ©