

Start Here

1

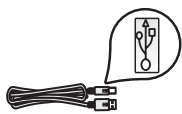

USB cable users: Do not connect the USB cable until this guide instructs you to or the software may not install properly.

Use this guide to set up the hardware and connect the HP all-in-one to either your computer or network. If you have problems during setup, see **Troubleshooting** in the last section.

2

Remove all tape

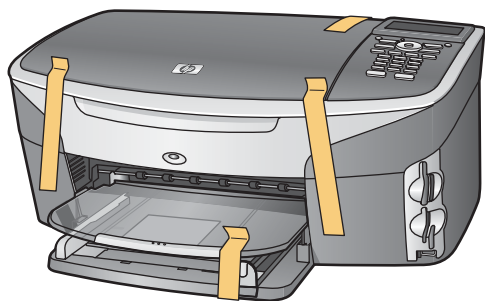

3

Locate components



Windows CD



print cartridges



phone cord



Macintosh CD



Ethernet cable
(wider end)



User Guide
& Network Guide

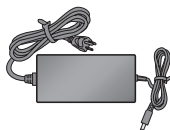

power cord and
adapter

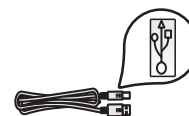

USB cable*

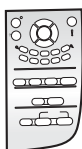

control-panel overlay
(may be attached)

* Purchased separately.

The contents of your box may differ. Additional equipment needed for network setup is specified later in this guide.

4

Attach the control-panel overlay (if not attached)

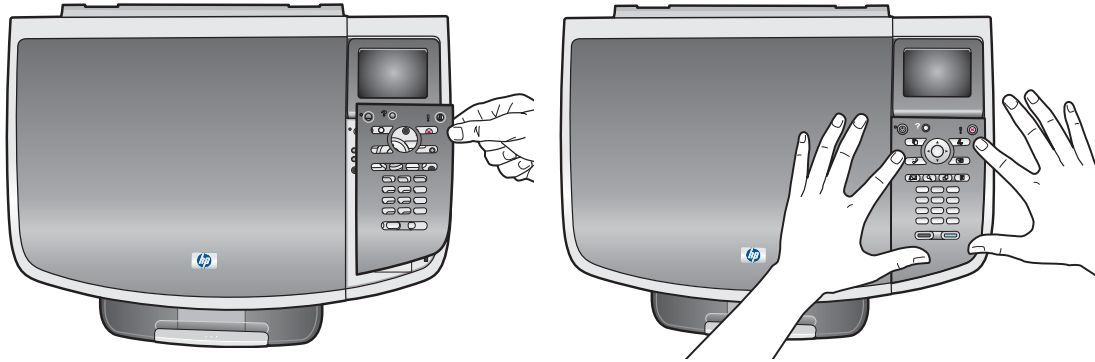

- a** Position the control-panel overlay above the device.
- b** Press down firmly on all edges of the overlay to secure it.

The control-panel overlay must be attached for the HP all-in-one to work!

5

Lift the color graphics display

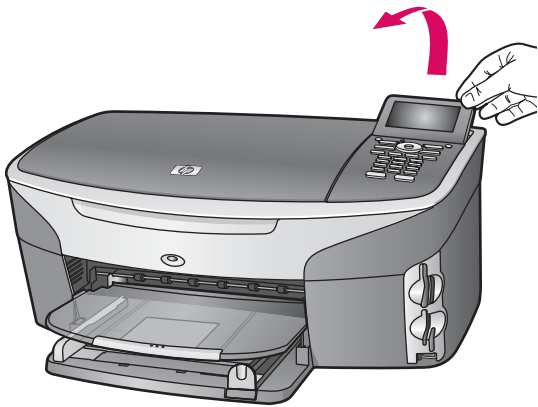

For best viewing, remove the protective film from the display.

6

Load plain white paper

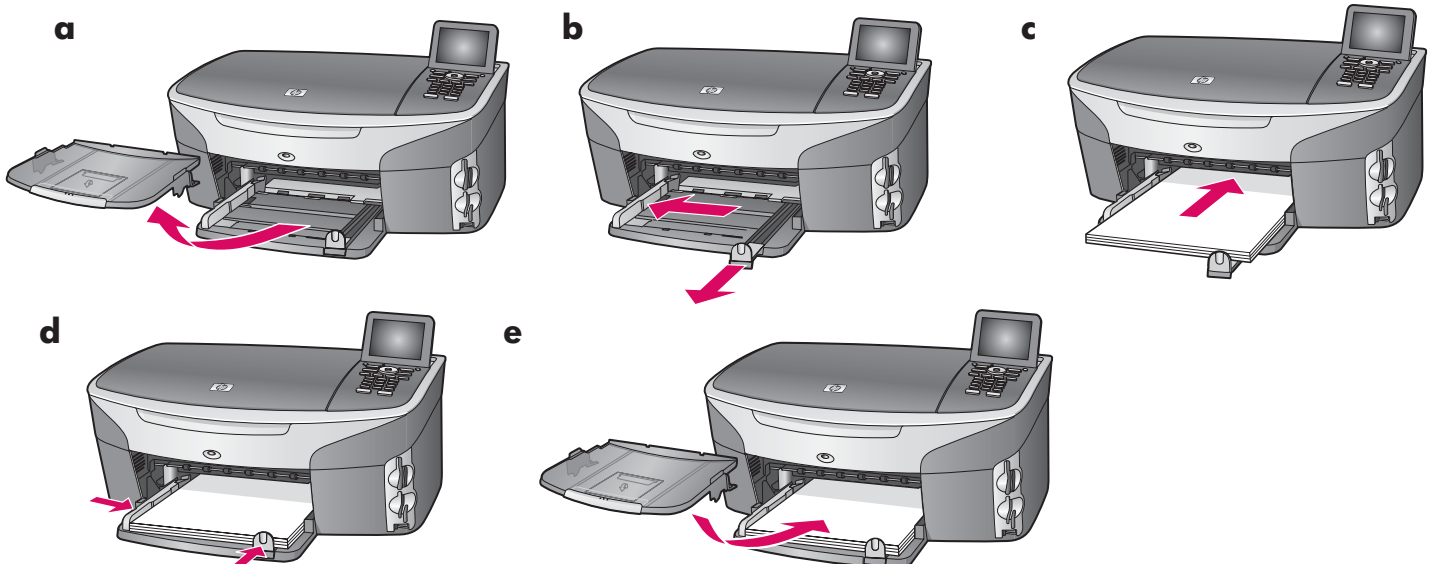

7

Connect the power cord and adapter

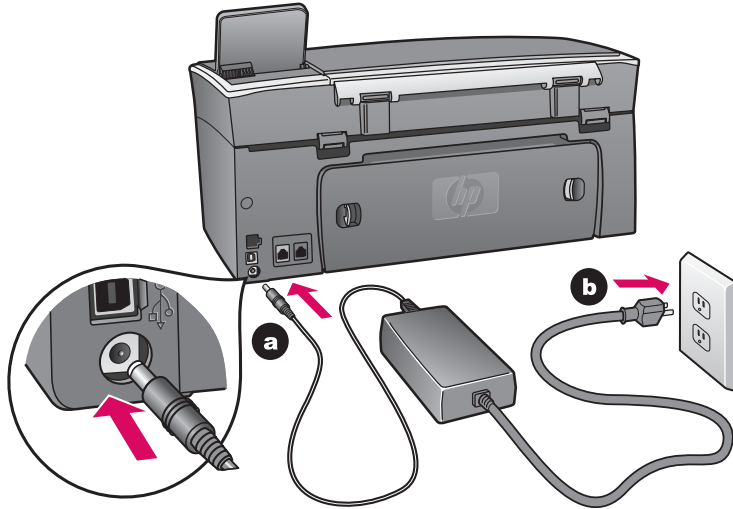

USB cable users: Do not connect the USB cable until this guide instructs you to or the software may not install properly.

8

Connect the supplied phone cord

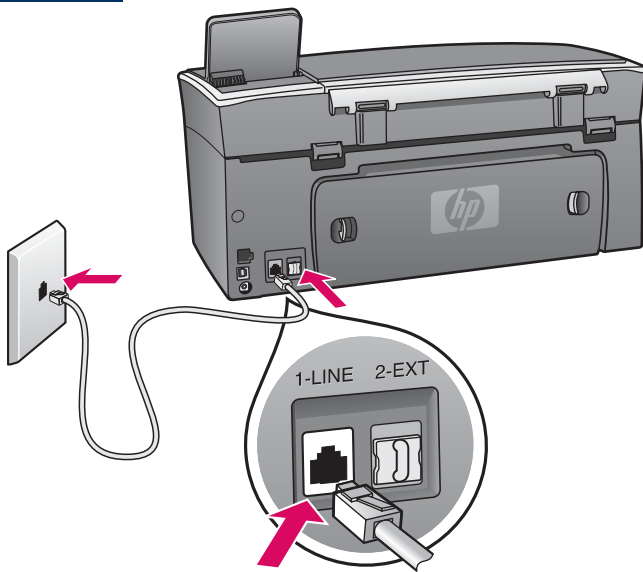

Connect one end of the supplied phone cord to the phone port on the left (**1-LINE**) and the other to a wall jack.

To connect an answering machine, see the **Fax Setup** chapter in the User Guide. To use a different phone cord, see the **Troubleshooting Information** chapter in the User Guide.

9 Press the On button



- a After you press the **On** button, the green light flashes, and then becomes solid. This may take up to a minute.
- b Wait for the print cartridge prompt before continuing.

10 Open access door

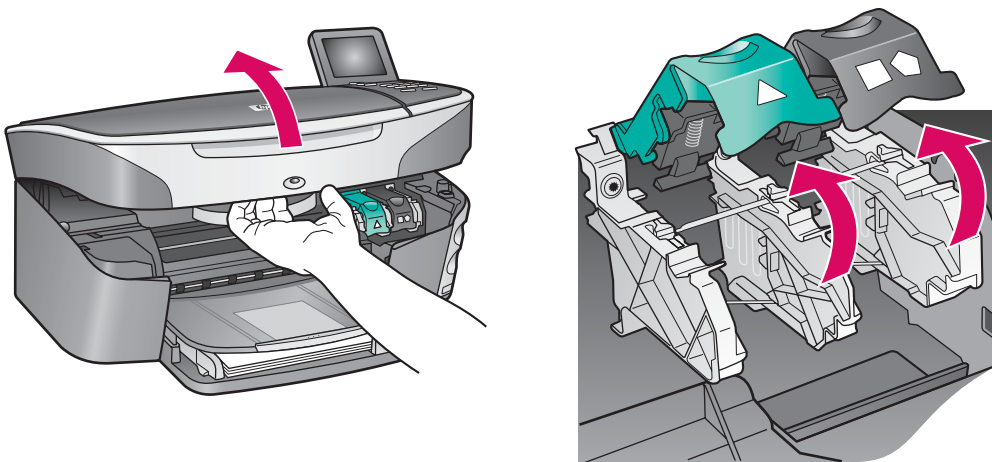

- a Lift the access door.
- b Press down and lift up the green and black latches on the inside of the HP all-in-one.

11 Remove tape from both cartridges

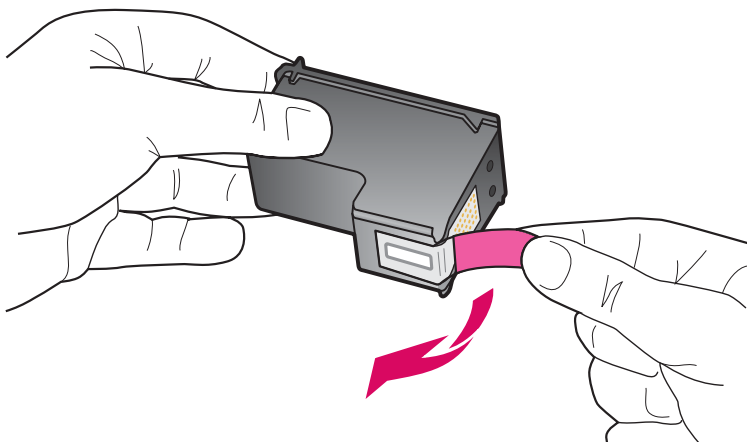

Pull the pink tab to remove the tape from **both** print cartridges.



Do not touch the copper-colored contacts or retape the cartridges.

12 Insert the tri-color print cartridge

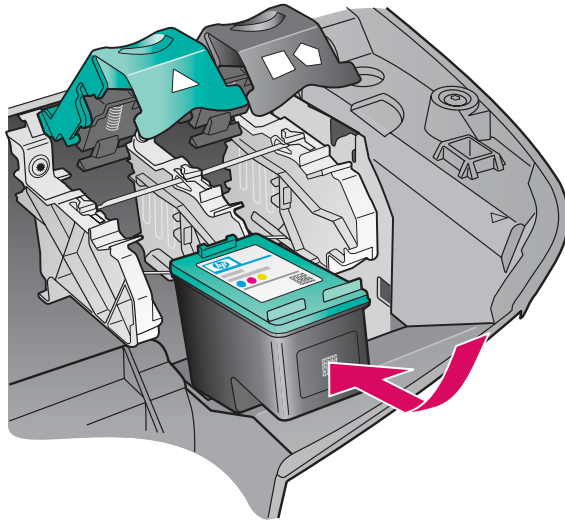

Make sure the device is **ON** before continuing.

- a** Hold the **tri-color** print cartridge with the HP label facing up.
- b** Place the **tri-color** print cartridge in front of the **left** slot.
- c** Push the cartridge firmly into the slot until it stops.

13 Insert the black print cartridge

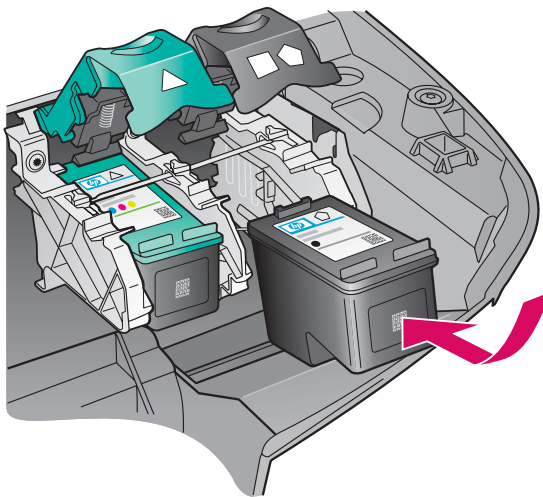

- a** Hold the **black** print cartridge with the HP label facing up.
- b** Place the **black** print cartridge in front of the **right** slot.
- c** Push the cartridge firmly into the slot until it stops.
- d** Push the latches down to close, and then close the access door.

The print cartridges may not be the same size.

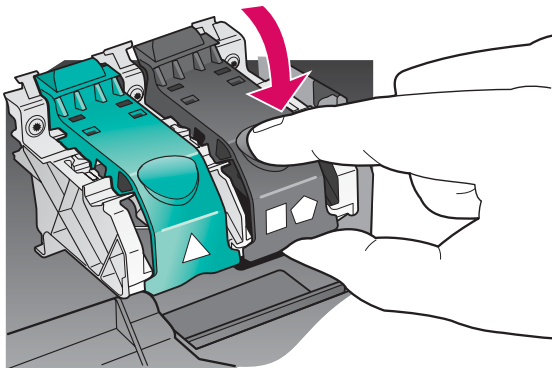

14 Align the print cartridges



- a Press **OK** at each of the prompts on the control panel to start print cartridge alignment.

The alignment may take a few minutes.

- b After the page prints, alignment is complete. Check the color graphics display for the status, and then press **OK**.

Recycle or discard the alignment page.



15 Turn on your computer



- a Turn on your computer, login if necessary, and then wait for the desktop to appear.

- b Close any open programs.

16

Choose ONE connection type (A or B or C)

A: USB Connection

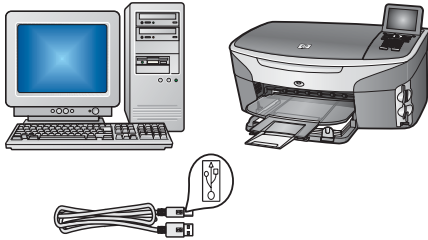

Use this connection type if you want to connect the device directly to one computer. **(Do not connect until the software instructs you to.)**

Equipment needed: USB cable.

For a USB connection, go to Section A for instructions.

B: Ethernet (Wired) Network

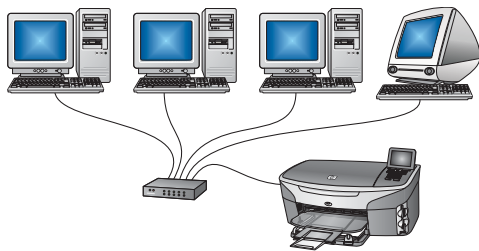
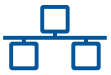

Use this connection type if you want an Ethernet cable connection between the device and your network.

Equipment needed: hub/router/switch and Ethernet cable.

For an Ethernet cable connection, go to Section B for instructions.

C: Wireless (Access Point) Connection

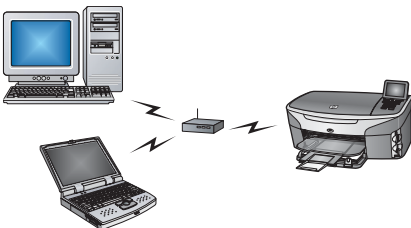

Use this connection type if you want a wireless (802.11 b or g) connection between the device and your network.

Requires a wireless hub or access point.*

For a wireless access point connection, go to Section C for instructions.

*If you do not have an access point, but want to connect your wireless computer to the device, see the **Connect to a wireless network without an access point** chapter in the Network Guide.

If you are not connecting the device to a computer or network, continue to the **Fax Setup** chapter in the User Guide.



Section A: USB connection

A1 Insert the correct CD

Windows Users:

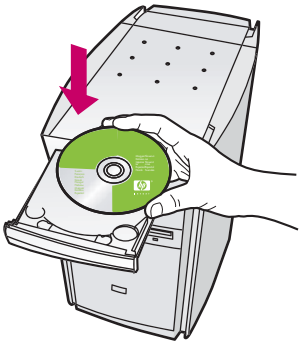

- a Insert the HP all-in-one **Windows** CD.
- b Follow the onscreen instructions.
- c On the **Connection Type** screen, make sure to select **directly to this computer**. Continue to the next page.

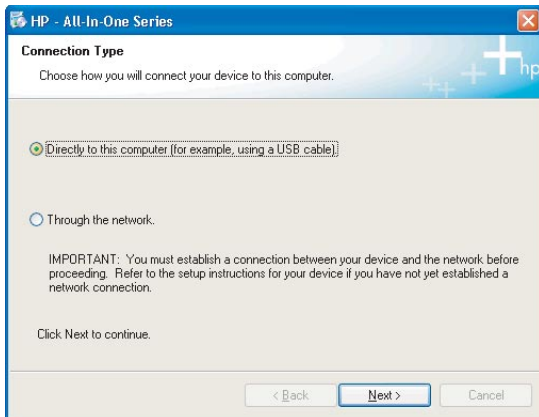

If the startup screen does not appear, double-click **My Computer**, double-click the **CD-ROM** icon, and then double-click **setup.exe**.

Macintosh Users:

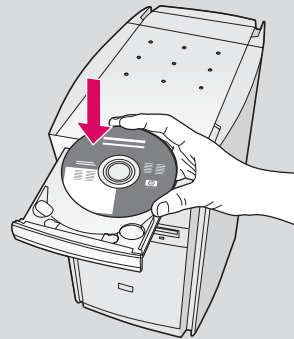

Insert the HP all-in-one **Macintosh** CD. Go to the next page before installing the software.

Connect the USB cable

Windows Users:

- a** You may have to wait several minutes before you see the onscreen prompt to connect the USB cable. Once the prompt appears, connect the USB cable to the port on the back of the HP all-in-one, and then to **any USB port** on your computer.

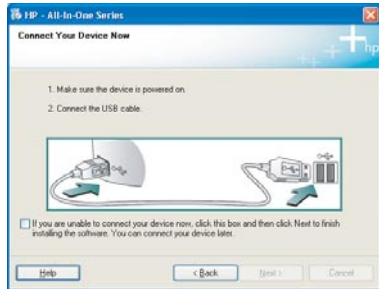

If you do not see this screen, see **Troubleshooting** in the last section.

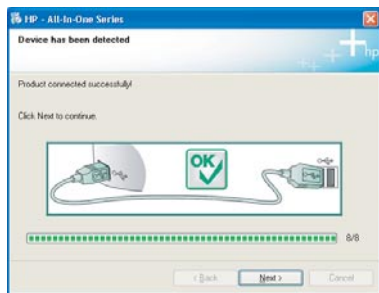
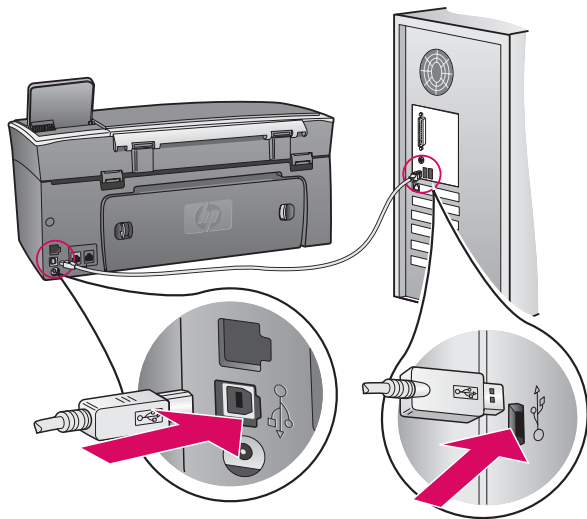

- b** Follow the onscreen instructions to complete the **Fax Setup Wizard** and **Sign up now** screens.

Macintosh Users:

- a** Connect the USB cable from your computer to the USB port on the back of the device.

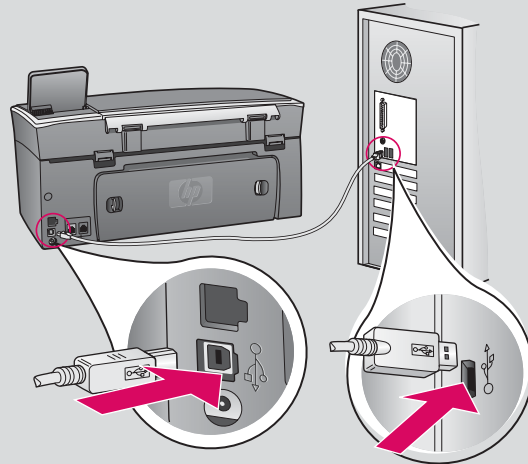

- b** Double-click the **HP All-in-One installer** icon.

- c** Make sure you complete all screens, including the Setup Assistant. You must select **USB**. Also, you must click the **Print Center** button to add the HP all-in-one to your printer list.

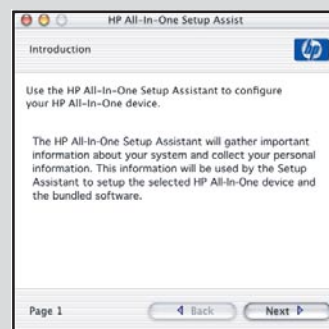

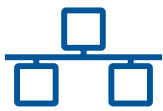

Section B: Ethernet (Wired) Network

B1

Connect the Ethernet cable

a

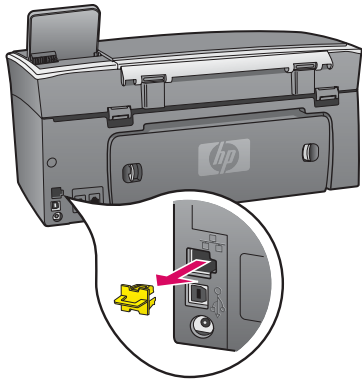

a Remove the yellow plug from the back of the device.

b Connect one end of the Ethernet cable to the Ethernet port on the back of the device.

c Connect the other end of the Ethernet cable to the hub/router/switch. If the cable is not long enough, you can purchase a longer cable.

b

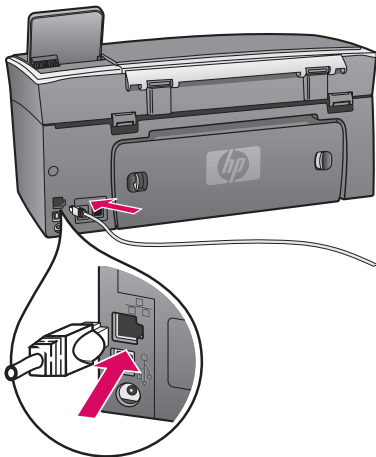

c

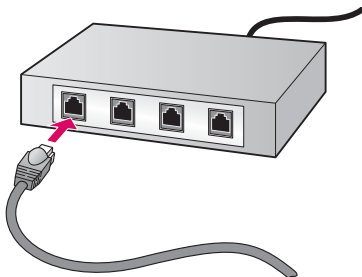

Important: Do not connect the Ethernet cable to a cable modem. You must have a working network. If you already connected the USB cable, do not connect the Ethernet cable.

Choose the correct CD

Windows Users:

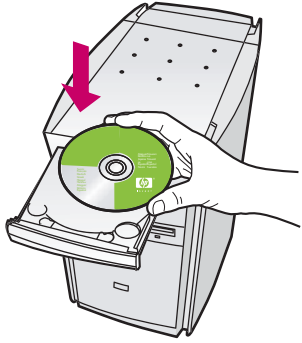

- Insert the HP all-in-one **Windows** CD.
- Follow the onscreen instructions.
- On the **Connection Type** screen, make sure to select **through the network**. Follow the onscreen instructions.
- You must accept both firewall messages or setup will fail.

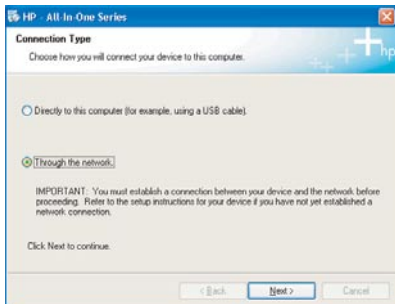

If the startup screen does not appear, double-click **My Computer**, double-click the **CD-ROM** icon, and then double-click **setup.exe**.

Macintosh Users:

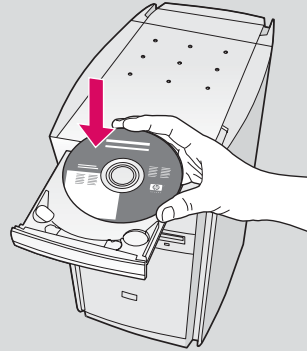

- Insert the HP all-in-one **Macintosh** CD.
- Double-click the **HP All-in-One installer** icon.

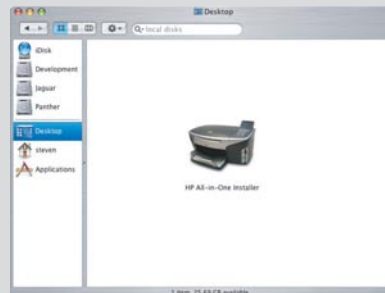

- Make sure you complete all screens, including the Setup Assistant. You must select **TCP/IP**. Also, you must click the **Print Center** button to add the HP all-in-one to your printer list.

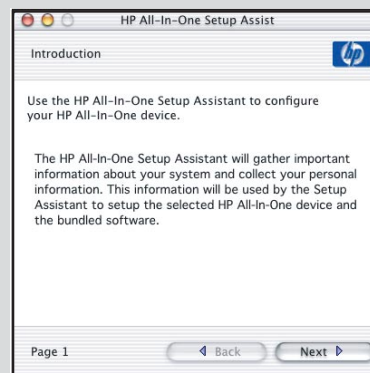

Go to step 17 on page 14.



Section C: Wireless (Access Point) Network

C1 Write down the required information

In the next step, you are required to enter information about your wireless network. Write down the information here for easy reference.

Information:

Network Name (also called SSID):

WEP/WPA Password or Passkey (if needed):

If you do not have this information, see the documentation that came with your wireless access point.

C2 Enter information on control panel



a On the control panel of the device, press the **Setup** button.

b Press **8** for the Network menu.

c When the Network menu appears, press **4** for the Wireless Setup Wizard.

A list of detected networks appears on the display. The networks with the strongest signals appear first.

d Highlight the name of the network that you wrote down in Step C1, and then press **OK**. (If your network is not listed, select **New Network** and enter your **Network Name**. Make sure there are no obstructions between the access point and your HP all-in-one.)

e If your network is encrypted, you will be prompted to enter the WEP key or WPA password. Both are case sensitive. See **Display keyboard tips** to your left.

f Follow the prompts on the display. If the connection is successful, go to the next page. If the connection fails, see **Troubleshooting** in the last section.

Display keyboard tips:

To Select: Use Arrow keys to highlight, and then **OK**.

For mistakes: Select **Clear**

For lowercase: Select **abc**

For numbers: Select **123**

When you are finished: Highlight **Done**, and then **OK**.

Choose the correct CD

Windows Users:

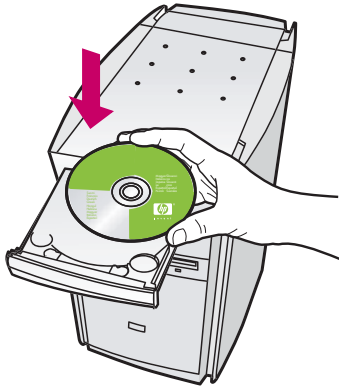

- Insert the HP all-in-one **Windows** CD.
- Follow the onscreen instructions.
- On the **Connection Type** screen, make sure to select **through the network**. Follow the onscreen instructions.
- You must accept both firewall messages or setup will fail.

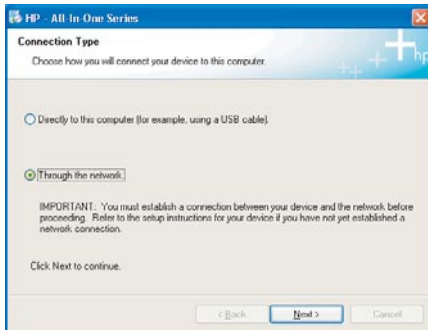

If the startup screen does not appear, double-click **My Computer**, double-click the **CD-ROM** icon, and then double-click **setup.exe**.

Macintosh Users:

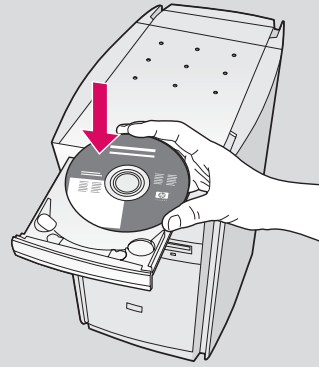

- Insert the HP all-in-one **Macintosh** CD.
- Double-click the **HP All-in-One installer** icon.

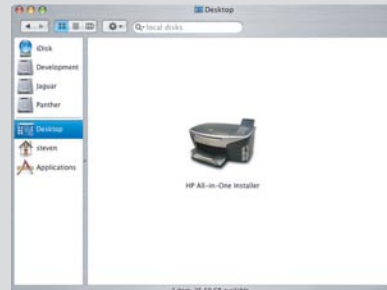

- Make sure you complete all screens, including the Setup Assistant. You must select **TCP/IP**. Also, you must click the **Print Center** button to add the HP all-in-one to your printer list.

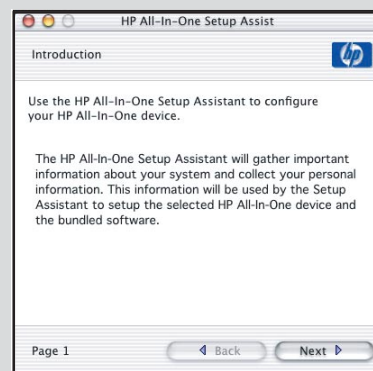

17

Congratulations

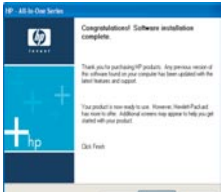

When you see the **Congratulations!** screen, you are ready to use your HP all-in-one. See the User Guide or onscreen help to get started.

If you have additional computers on your network, go to the next step.



Tips:

If you are not using a wireless network and want to turn off the blue light, press **Setup, 8, 5,** and then **2.**

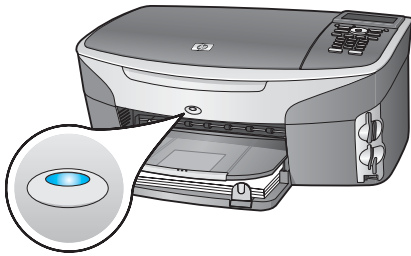

To prevent paper from flying out of the output tray, pull, and then flip the paper tray extender out.

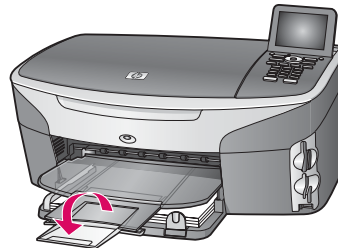

18

Set up additional computers (optional)

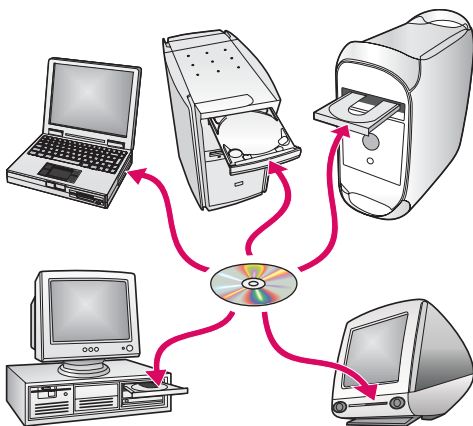

If you have additional computers on your network, then install the HP all-in-one software on each computer.

Follow the onscreen instructions. Make sure that you choose the connection type between the network and your HP all-in-one (not between your computer and the network).



Problem: You are trying to set up a wireless connection through the control panel, and the device does not connect to the network.

Action:

On the access point, turn on broadcast network name options, and turn off silent broadcast name.

Move the access point closer to the HP all-in-one and make sure there are no obstructions.

Turn the access point off, wait 30 seconds, and then on again.

Make sure you entered the correct wireless communication mode and authentication type. See steps C1 through C3.

See the Networking Guide for more details and troubleshooting information.

Problem: The **Printer Not Found** messages appears.

Action:

First make sure that you have an active connection with the device. Check your color graphics display for an icon. If you do not see an icon, go back to your connection type Section (B or C).

If you have an active connection, try the following:

Turn your device off, wait 30 seconds, and then on.

Try temporarily disconnecting your firewall.

Wired (Ethernet) network users - Make sure your cables are connected. Check the cable between the router and the device. Check the cable between your computer and the device.

Make sure your LAN card is set up properly.

See the Network Guide for more information.

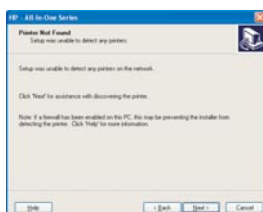

See the **Network Guide** for in-depth information on troubleshooting and additional setup information.

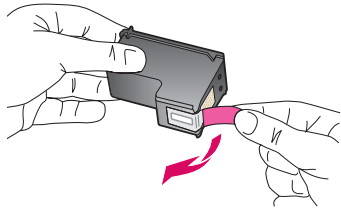

Problem: The **Remove and check print cartridges** message appears after you insert print cartridges.

Action: Remove print cartridges. Make sure you remove all tape from copper contacts. Close the access door.

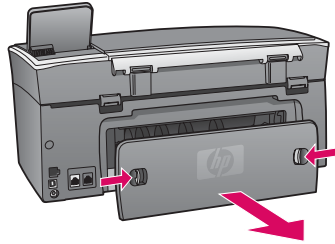

Problem: The paper has jammed.

Action: Remove the back access door and gently pull out any paper. Turn the device off, and then on. Load the paper again.



Problem: You did not see the screen prompting you to connect the USB cable.

Action: Remove, and then re-insert the HP all-in-one **Windows** CD. Refer to Section A.



Problem: The **Microsoft Add Hardware** screen appears.

Action: Click **Cancel**. Unplug the USB cable, and then insert the HP all-in-one **Windows** CD. Refer to Section A.

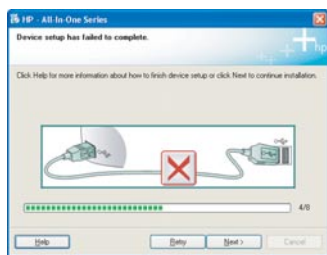

Problem: The **Device Setup Has Failed To Complete** screen appears.

Action: Verify that the control-panel overlay is firmly attached. Unplug the HP all-in-one and plug it in again. Check all connections. Make sure the USB cable is plugged into the computer. Do not plug the USB cable into a keyboard or non-powered hub. Refer to Section A.



Problem: The Macintosh software does not install.

Action: Make sure the USB cable is plugged into the computer before installing the software. Do not plug the USB cable into a keyboard or non-powered hub. Refer to Section A. For network software problems, see the Network Guide.

