



PHILIPS

English

FW-C250



Toll Free Help Line
Ligne d'assistance en service libre
Línea de ayuda telefónica sin cargo
800-531-0039

Let's make things better.



PHILIPS

2

Return your Warranty Registration card today to ensure you receive all the benefits you're entitled to.

- Once your Philips purchase is registered, you're eligible to receive all the privileges of owning a Philips product.
- So complete and return the Warranty Registration Card enclosed with your purchase at once. And take advantage of these important benefits.

Warranty Verification

Registering your product within 10 days confirms your right to maximum protection under the terms and conditions of your Philips warranty.

Owner Confirmation

Your completed Warranty Registration Card serves as verification of ownership in the event of product theft or loss.

Model Registration

Returning your Warranty Registration Card right away guarantees you'll receive all the information and special offers which you qualify for as the owner of your model.

Know these *safety* symbols



This "bolt of lightning" indicates uninsulated material within your unit may cause an electrical shock. For the safety of everyone in your household, please do not remove product covering.



The "exclamation point" calls attention to features for which you should read the enclosed literature closely to prevent operating and maintenance problems.

For Customer Use

Enter below the Serial No. which is located on the rear of the cabinet. Retain this information for future reference.

Model No. _____

Serial No. _____

WARNING: TO PREVENT FIRE OR SHOCK HAZARD, DO NOT EXPOSE THIS EQUIPMENT TO RAIN OR MOISTURE.

CAUTION: To prevent electric shock, match wide blade of plug to wide slot, and fully insert.

MAC5097

3

PHILIPS Visit our World Wide Web Site at <http://www.philipsusa.com>

PHILIPS

***Congratulations on your purchase,
and welcome to the "family!"***

Dear Philips product owner:

Thank you for your confidence in Philips. You've selected one of the best-built, best-backed products available today. And we'll do everything in our power to keep you happy with your purchase for many years to come.

As a member of the Philips "family," you're entitled to protection by one of the most comprehensive warranties and outstanding service networks in the industry.

What's more, your purchase guarantees you'll receive all the information and special offers for which you qualify, plus easy access to accessories from our convenient home shopping network.



And most importantly you can count on our uncompromising commitment to your total satisfaction.

All of this is our way of saying welcome—and thanks for investing in a Philips product.

Sincerely,

Robert Minkhorst
President and Chief Executive Officer

P.S. Remember, to get the most from your Philips product, you must return your Warranty Registration Card within 10 days. So please mail it to us right now!



4

IMPORTANT SAFETY INSTRUCTIONS – Read before operating equipment

This product was designed and manufactured to meet strict quality and safety standards. There are, however, some installation and operation precautions which you should be particularly aware of.

1. **Read these instructions** – All the safety and operating instructions should be read before the appliance is operated.
2. **Keep these instructions** – The safety and operating instructions should be retained for future reference.
3. **Heed all warnings** – All warnings on the appliance and in the operating instructions should be adhered to.
4. **Follow all instructions** – All operating and use instructions should be followed.
5. **Do not use this apparatus near water** – for example, near a bathtub, washbowl, kitchen sink, laundry tub, in a wet basement or near a swimming pool, etc.
6. **Clean only with a damp cloth.** The appliance should be cleaned only as recommended by the manufacturer.

7. Install in accordance with the manufacturer's instructions. Do not block any of the ventilation openings.

For example, the appliance should not be situated on a bed, sofa, rug, or similar surface or placed in a built-in installation, such as a bookcase or cabinet that may impede the flow of air through the ventilation openings.

8. Do not install near any heat sources such as radiators, heat registers, stoves, or other apparatus (including amplifiers) that produce heat.

9. Do not defeat the safety purpose of the polarized or grounding-type plug.

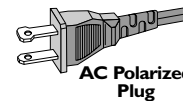

A polarized plug has two blades with one wider than the other. A grounding type plug has two blades and a third grounding prong. The wide blade or the third prong are provided for your safety. When the provided plug does not fit into your outlet, consult an electrician for replacement of the obsolete outlet.

10. Protect the power cord from being walked on or pinched particularly at plugs, convenience receptacles, and the point where they exit from the apparatus.

11. Only use attachments/accessories specified by the manufacturer.

12.  **Use only with a cart,** stand, tripod, bracket, or table specified by the manufacturer; or sold with the apparatus. When a cart is used, use caution when moving the cart/apparatus combination to avoid injury from tip-over.

13. Unplug this apparatus during lightning storms or when unused for long periods of time.

14. Refer all servicing to qualified service personnel. Servicing is required when the apparatus has been damaged in any way, such as power-supply cord or plug is damaged, liquid has been spilled or objects have fallen into the apparatus, the apparatus has been exposed to rain or moisture, does not operate normally, or has been dropped.

15. Battery usage CAUTION – To prevent battery leakage which may result in bodily injury or damage to the unit:

- Install **all** batteries correctly, + and - as marked on the unit.
- Do not mix batteries (**old** and **new** or **carbon** and **alkaline**, etc.).
- Remove batteries when the unit is not used for a long time.

EL 6475-E001: 00/8





5

LIMITED WARRANTY

AUDIO SYSTEM

One Year Free Labor
One Year Free Service on Parts

This product must be carried in for repair.

WHO IS COVERED?

You must have proof of purchase to receive warranty service. A sales receipt or other document showing that you purchased the product is considered proof of purchase.

WHAT IS COVERED?

Warranty coverage begins the day you buy your product. For one year thereafter, all parts will be repaired or replaced, and labor is free. After one year from the day of purchase, you pay for the replacement or repair of all parts, and for all labor charges.

All parts, including repaired and replaced parts, are covered only for the original warranty period. When the warranty on the product expires, the warranty on all replaced and repaired parts also expires.

WHAT IS EXCLUDED?

Your warranty does not cover:

- labor charges for installation or setup of the product, adjustment of customer controls on the product, and installation or repair of antenna systems outside of the product.
- product repair and/or part replacement because of misuse, accident, unauthorized repair or other cause not within the control of Philips Consumer Electronics Company.
- reception problems caused by signal conditions or cable or antenna systems outside the unit.
- a product that requires modification or adaptation to enable it to operate in any country other than the country for which it was designed, manufactured, approved and/or authorized, or repair of products damaged by these modifications.
- incidental or consequential damages resulting from the product. (Some states do not allow the exclusion of incidental or consequential damages, so the above exclusion may not apply to you. This includes, but is not limited to, prerecorded material, whether copyrighted or not copyrighted.)

- a product that is used for commercial or institutional purposes.

WHERE IS SERVICE AVAILABLE?

Warranty service is available in all countries where the product is officially distributed by Philips Consumer Electronics Company. In countries where Philips Consumer Electronics Company does not distribute the product, the local Philips service organization will attempt to provide service (although there may be a delay if the appropriate spare parts and technical manual(s) are not readily available).

MAKE SURE YOU KEEP..

Please keep your sales receipt or other document showing proof of purchase. Attach it to this owner's manual and keep both nearby. Also keep the original box and packing material in case you need to return your product.

BEFORE REQUESTING SERVICE...

Please check your owner's manual before requesting service. Adjustments of the controls discussed there may save you a service call.

TO GET WARRANTY SERVICE IN U.S.A., PUERTO RICO OR U.S. VIRGIN ISLANDS...

Take the product to a Philips factory service center (see enclosed list) or authorized service center for repair. When the product has been repaired, you must pick up the unit at the center. Centers may keep defective parts.

(In U.S.A., Puerto Rico and U.S. Virgin Islands, all implied warranties, including implied warranties of merchantability and fitness for a particular purpose, are limited in duration to the duration of this express warranty. But, because some states do not allow limitations on how long an implied warranty may last, this limitation may not apply to you.)

TO GET WARRANTY SERVICE IN CANADA...

Please contact Philips at:

1-800-661-6162 (French Speaking)
1-800-363-7278 (English Speaking)

(In Canada, this warranty is given in lieu of all other warranties. No other warranties are expressed or implied, including any implied warranties of merchantability or fitness for a particular purpose. Philips is not liable under any circumstances for any direct, indirect, special, incidental or consequential damages, howsoever incurred, even if notified of the possibility of such damages.)

REMEMBER...

Please record the model and serial numbers found on the product below. Also, please fill out and mail your warranty registration card promptly. It will be easier for us to notify you if necessary.

MODEL # _____

SERIAL # _____

This warranty gives you specific legal rights. You may have other rights which vary from state/province to state/province.

**Philips Service Solutions Group, P.O. Box 2976,
Longview, Texas 75606, USA, (903) 242-4800**

EL4965E006 / MAC 4110 / 12-98



6

	CAUTION RISK OF ELECTRIC SHOCK DO NOT OPEN	
CAUTION: TO REDUCE THE RISK OF ELECTRIC SHOCK, DO NOT REMOVE COVER (OR BACK). NO USER-SERVICEABLE PARTS INSIDE. REFER SERVICING TO QUALIFIED SERVICE PERSONNEL.		



This symbol warns the user that uninsulated voltage within the unit may have sufficient magnitude to cause electric shock. Therefore, it is dangerous to make any kind of contact with any inside part of this unit.



This symbol alerts the user that important literature concerning the operation and maintenance of this unit has been included. Therefore, it should be read carefully in order to avoid any problems.

WARNING

To reduce the risk of fire or electric shock, do not expose this appliance to rain or moisture.

CAUTION

Use of controls or adjustments or performance of procedures other than herein may result in hazardous radiation exposure.

The set complies with the FCC-Rules, Part 15 and with 21 CFR 1040.10.

Canada

This digital apparatus does not exceed the Class B limits for radio noise emissions from digital apparatus as set out in the Radio Interference Regulations of the Canadian Department of Communications.



Read this first!

Congratulations on your purchase of this Philips product! Everything you need to get started is in this box.

If you have any problems, Philips Representatives can help you get the most from your new product by explaining:

- Hookup
- FirstTime Setup
- Feature Operation

Do not attempt to return this product to the store.

For Fast Help, Call Us First!

1-800-531-0039

Thank you for making Philips part of your home!

PLUG & PLAY		
1 Plug in the unit	2 Follow instructions in the display	3 Press "PLAY"
DEMO MODE		
To turn ON Press & HOLD button for 5 seconds	To turn OFF Press & HOLD button for 5 seconds	





7

GENERAL INFORMATION

SAFETY INFORMATION

General Information

- **The typeplate (which contains the serial number) is located at the rear of the system.**
- **Recording is permissible if copyright or other rights of third parties are not infringed.**
- **This device complies with the Federal Communications Commission (FCC) rules, part 15 and with 21 CFR 1040.10. Operation is subject to the following two conditions:**
 - **This device may not cause harmful interference, and**
 - **This device must accept any interference received, including undesired operation.**

Environmental Information

All unnecessary packaging has been omitted. We have tried to make the packaging easy to separate into three materials: cardboard (box), polystyrene foam (buffer) and polyethylene (bags, protective foam sheet).

Your system consists of materials which can be recycled and reused if disassembled by a specialized company. Please observe the local regulations regarding the disposal of packaging materials, exhausted batteries and old equipment.

Accessories (Supplied)

- Remote control
- AM loop antenna
- FM wire antenna
- AC power cord

Safety Information

- Before operating the system, check that the operating voltage indicated on the typeplate (or the voltage indication beside the voltage selector) of your system is identical with the voltage of your local power supply. If not, please consult your dealer. The typeplate is located at the rear of your system.
- When the system is switched on, do not move it around.
- Place the system on a solid base (e.g. a cabinet).
- Place the system in a location with adequate ventilation to prevent internal heat build-up in your system. Allow at least 10cm (4 inches) clearance from the rear and the top of the unit and 5cm (2 inches) from each side.
- Do not expose the system to excessive moisture, rain, sand or heat sources.

- Under no circumstances should you repair the system yourself, as this will invalidate the warranty!
- If the system is brought directly from a cold to a warm location, or is placed in a very damp room, moisture may condense on the lens of the CD unit inside the system. Should this occur, the CD player will not operate normally. Leave the power on for about one hour with no disc in the system until normal playback is possible.
- Electrostatic discharge may cause unexpected problems. See whether these problems disappear if you unplug the AC power cord and plug it in again after a few seconds.
- **To disconnect the system from the power supply completely, remove the AC power plug from the wall socket.**





8

PREPARATION

Rear Connections

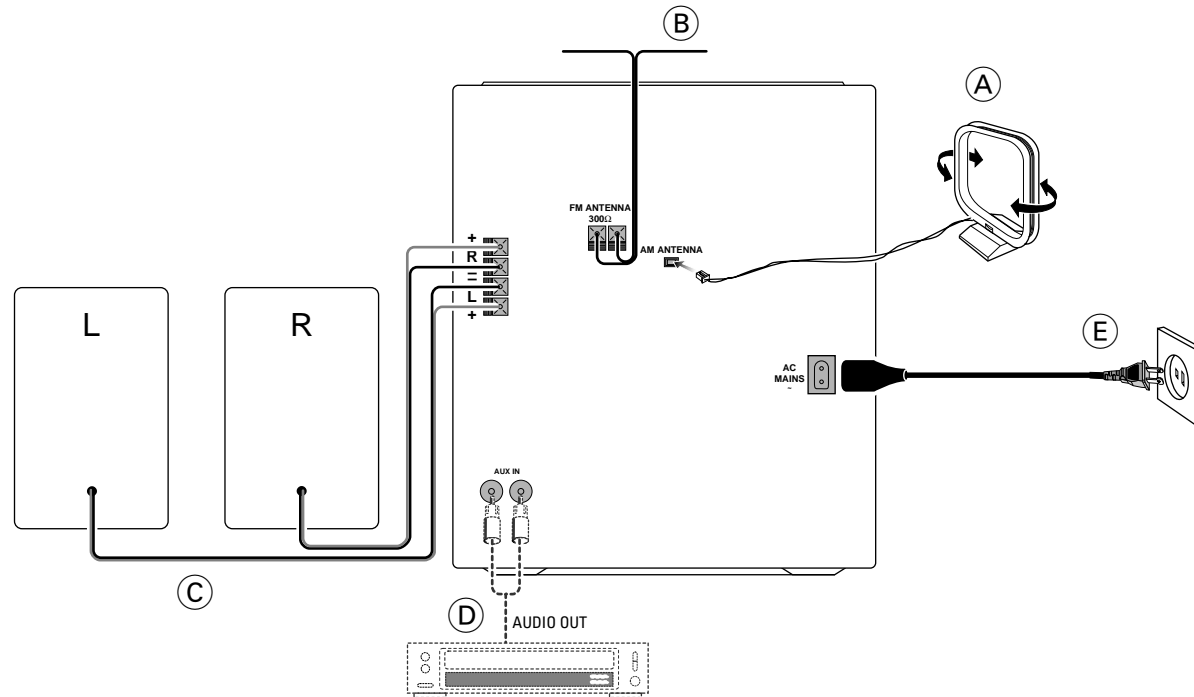

9

PREPARATION

(A) AM Loop Antenna Connection

Connect the supplied loop antenna to the AM ANTENNA terminal. Place the AM loop antenna far away from the system and adjust its position for the best reception.

(B) FM Wire Antenna Connection

Connect the supplied FM wire antenna to the FM AERIAL (FM ANTENNA) 300 Ω terminal. Adjust the position of the FM antenna for the best reception.

Outdoor Antenna

For better FM stereo reception, connect an outdoor FM antenna to the FM AERIAL (FM ANTENNA) 300 Ω terminal using a 300 Ω dipole wire.

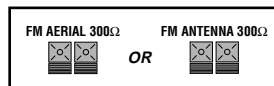

(C) Speakers Connection

- Connect the right speaker to Front terminal R, with the colored wire to + and the black wire to -.
- Connect the left speaker to Front terminal L, with the colored wire to + and the black wire to -.
- Clip the stripped portion of the speaker wire as shown.

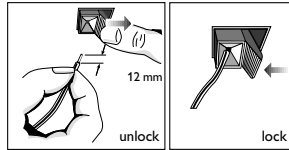

CAUTION:

- For optimal sound performance, it is recommended to use the supplied speakers.
- Do not connect more than one speaker to any one pair of + / - speaker terminal.
- Do not connect speakers with impedance lower than the speakers supplied. Please refer to SPECIFICATION section of this manual.

(D) Connecting other equipment to your system

You can connect the audio left and right OUT terminals of a TV, VCR, Laser Disc player, DVD player or CD Recorder to the AUX IN terminals at the rear of the system.

(E) AC Power Supply

After all other connections have been made, connect the AC power cord to the system and to the wall outlet.

Inserting batteries into the Remote Control

- Insert the batteries (*not supplied*) into the remote control as shown in the battery compartment (Type R06 or AA).

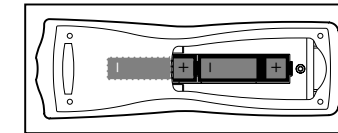

CAUTION

- Remove batteries if they are exhausted or not to be used for a long time.
- Do not use old and new or different types of batteries in combination.
- Batteries contain chemical substances, so they should be disposed off properly.



10

CONTROLS

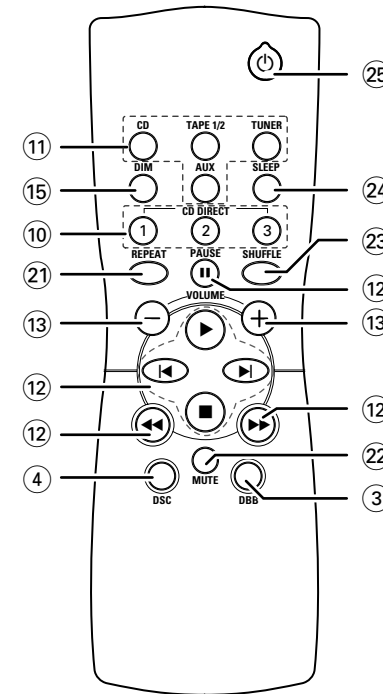
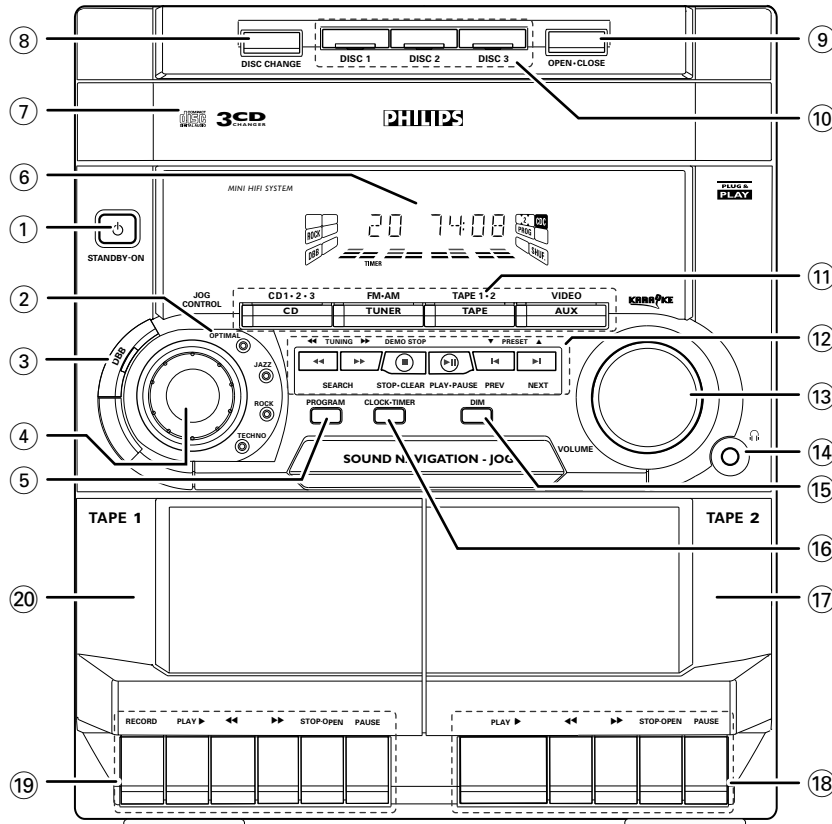

Controls on the system and remote control

- ① **STANDBY-ON**
 - to switch the system on or to standby mode.
- ② **DIGITAL SOUND CONTROL DISPLAY PANEL**
 - to view the desired DSC display.
- ③ **DBB (DYNAMIC BASS BOOST)**
 - to switch on bass boost to enhance bass response or to switch off bass boost.
- ④ **JOG CONTROL/DSC**
 - to select the desired sound effect : OPTIMAL, JAZZ, ROCK or TECHNO.
- ⑤ **PROGRAM**
 - for CD to program CD tracks.
 - for TUNER ... to program preset radio stations.
 - for CLOCK .. to select 12 or 24 hour in clock setting mode.
- ⑥ **DISPLAY SCREEN**
 - to view the current setting of the system.
- ⑦ **CD CHANGER TRAY**
- ⑧ **DISC CHANGE**
 - to change disc(s).
- ⑨ **OPEN-CLOSE**
 - to open or close the CD changer tray.

- ⑩ **DISC 1 / DISC 2 / DISC 3 (CD DIRECT PLAY)**
 - to select a CD tray for playback.
- ⑪ **SOURCE** – to select the following:
 - CD / (CD 1•2•3)**
 - to select CD mode. When disc playback is stopped, press to select disc tray 1, 2 or 3.
 - TUNER / (FM•AM)**
 - to select Tuner mode. When in tuner mode, press to select the waveband: FM or AM.
 - TAPE / (TAPE 1• 2)**
 - to select Tape mode.
 - AUX (VIDEO)**
 - to select sound from an external source (e.g. TV, VCR, Laser Disc player, DVD player or CD Recorder).
- ⑫ **MODE SELECTION SEARCH ◀▶ (TUNING ◀▶)**
 - for CD to search backward/ forward.
 - for TUNER to tune to a lower or higher radio frequency.
 - for CLOCK .. to set the hour (*on the system only*) .
- STOP-CLEAR ■**
 - for CD to stop disc playback or to clear a programme.
 - for TUNER ... to stop programming (*on the system only*).

- for DEMO to start or stop demonstration mode (*on the system only*).
- for CLOCK .. to exit clock setting or cancel timer (*on the system only*).
- for PLUG & PLAY
 - to exit plug & play mode and return to standby mode (*on the system only*).
- PLAY ▶ / PAUSE II**
 - for CD to start or interrupt playback.
 - for PLUG & PLAY
 - to initiate and start plug & play from standby/demo mode (*on the system only*).
- PREV ◀ / NEXT ▶ (PRESET ▼▲)**
 - for CD to skip to the beginning of the current, previous, or next track.
 - for TUNER ... to select a preset station in memory.
 - for CLOCK .. to set the minute (*on the system only*) .
- ⑬ **VOLUME**
 - to increase or decrease the volume.
- ⑭ 
 - to connect headphones.

- ⑮ **DIM**
 - to select different brightness for the display screen : DIM 1, DIM 2, DIM 3 or DIM OFF.
- ⑯ **CLOCK-TIMER**
 - to view the clock, set the clock or set the timer.
- ⑰ **TAPE DECK 2**
- ⑱ **TAPE DECK 2 OPERATION PLAY ▶** to start playback.
 - ◀..... to rewind the tape.
 - ▶▶ to fast forward the tape.
- STOP-OPEN** ... to stop playback or to open the tape door.
- PAUSE** to interrupt playback.
- ⑲ **TAPE DECK 1 OPERATION RECORD** ... to start recording.
 - PLAY ▶** to start playback.
 - ◀..... to rewind the tape.
 - ▶▶ to fast forward the tape.
- STOP-OPEN** ... to stop playback/ recording or to open the tape door.
- PAUSE** to interrupt playback or recording.
- ⑳ **TAPE DECK 1 REPEAT**
 - to repeat a track, a disc, or all available discs.
- ㉑ **MUTE**
 - to switch off the sound temporarily.

- 23 **SHUFFLE**
 - to play all the available discs and their tracks in random order.
- 24 **SLEEP**
 - to switch the system to standby mode at a selected time.
- 25 
 - to switch the system to standby mode.

Notes for remote control:

- **First select the source you wish to control by pressing one of the source select keys on the remote control (e.g. CD or TUNER).**
- **Then select the desired function (▶, ◀, ▶, etc.).**

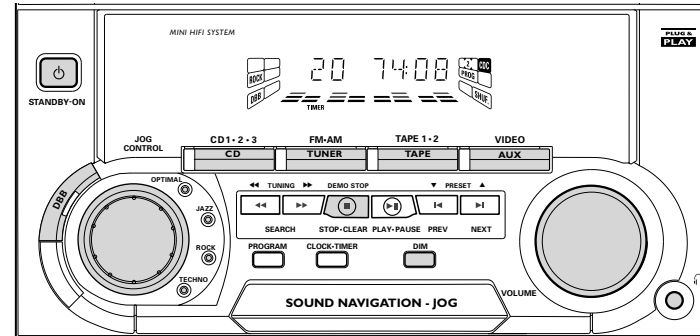

Important:
Before you operate the system, complete the preparation procedures.

Plug and Play

The system provides PLUG and PLAY feature that allows you to store all available radio stations automatically upon power up. **If PLUG and PLAY has been installed beforehand, it will go to standby or demonstration mode after five seconds.**

- 1 Press and hold **PLAY** (on the system only) for five seconds; when the system is in standby or demonstration mode.

- If the PLUG and PLAY has not been installed before, you can access this feature by switching on the system from the main power outlet.
 → "AUTO INSTALL - PRESS PLAY" will be displayed.
- 2 Press **PLAY** to start installation.
 → "INSTALL" will be displayed and followed by "TUNER" and then "AUTO".
 → The **PROGRAM** starts flashing.
 → PLUG and PLAY will start searching for all radio stations on FM band and then followed by radio stations on AM band.
 → All available radio stations with sufficient signal strength will be stored. Up to 40 presets may be stored.

→ The last preset radio station will appear on the display when PLUG and PLAY is completed.

- To exit without storing the PLUG and PLAY, press ■ button (on the system only).

Notes:

- PLUG and PLAY will be reinitiated again during the next power up if:
 - i) PLUG and PLAY installation was not completed.
 - ii) No stereo frequency being detected during PLUG and PLAY, "CHECK ANTENNA" will be displayed.
- You can store any radio stations manually or automatically after PLUG and PLAY.
- When PLUG and PLAY is used, all previously stored radio stations will be replaced.
- During PLUG and PLAY, if no button is pressed within 15 seconds, the system will go to demonstration mode (if demonstration mode is enable)

Demonstration mode

The system has a demonstration mode that shows the various features offered by the system.

To disable the demonstration mode

- Press and hold ■ (on the system only) for **five seconds** when the system is in demonstration mode.
 - "DIM OFF" is displayed.
 - The system will switch to standby mode.

To enable the demonstration mode

- Press and hold ■ (on the system only) for **five seconds** when the system is in standby mode.
 - The demonstration will begin.

Notes:

- If the demonstration mode has not been disabled, it will resume five seconds later after the system switches to standby mode.
- When the system is switched on from the main power outlet, the CD changer tray may open and close again to initialize the set.
- Even though the AC power cord is removed from and reconnected to the wall socket, the demonstration will remain off until it is switched on again.

Switching the system ON

- Press **CD, TUNER, TAPE** or **AUX**.
- Press **STANDBY-ON** in demo.

You can also switch on the system by pressing any one of the CD DIRECT PLAY buttons (on the system only).

Switching the system to standby mode

- Press **STANDBY-ON** or ⏻ on the remote control.
 - The system will switch to standby mode.

Selecting the Source

- Press the respective source selection button: **CD, TUNER, TAPE** or **AUX**.
 - The display indicates the selected source.

Note:

- For an external source, make sure you have connected the audio left and right OUT terminals of the external equipment (TV, VCR, Laser Disc player, DVD player or CD Recorder) to the AUX IN terminals.

DIM mode

You can select the desired brightness for the display.

- Press **DIM** to select DIM 1, DIM 2, DIM 3 or DIM OFF display mode.
 - The **DIM** display lights up.
 - "DIM 1", "DIM 2", "DIM 3" or "DIM OFF" will be displayed depending on the mode selected.

DIM OFF - normal brightness with Spectrum Analyzer On

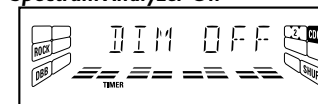

DIM 1 - normal brightness with Spectrum Analyzer Off



DIM 2 - half brightness with Spectrum Analyzer On



DIM 3 - half brightness with Spectrum Analyzer Off and all LEDs on the system will be switched off.



Sound Control

VOLUME ADJUSTMENT

Adjust **VOLUME** to increase or decrease the sound level.

For Personal Listening

Connect the headphones plug to the  socket at the front of the system. The speakers will be muted.

DIGITAL SOUND CONTROL (DSC)

The DSC feature enables you to enjoy special sound effects that have preset equalizer settings, providing the best music reproduction.

- Adjust **JOG CONTROL** to select OPTIMAL, JAZZ, ROCK or TECHNO.
→ The Digital Sound Control display panel will light up respectively.
→ "OPTIMAL", "JAZZ", "ROCK" or "TECHNO" and the respective flag will be displayed.

Note:

- When "OPTIMAL" sound is selected DBB will be switched on automatically.

DYNAMIC BASS BOOST (DBB)

The DBB mode enhances the bass response.

- Press **DBB** to switch on bass response.
→ The DBB button lights up.
→ "DBB ON" and the DBB flag will be displayed.

To switch off DBB

- Press **DBB** again.
→ The DBB button light is switched off.
→ "DBB OFF" will be displayed.

Note:

- Some discs or tapes might be recorded in high modulation, which causes a distortion at high volume. If this occurs, switch off DBB or reduce the volume.

MUTE (only on remote control)

This feature allows you to temporarily switch off the sound of the system without switching off the system when you require a moment of silence.

- Press **MUTE** on the remote control to switch off the sound.
→ "MUTE" and the MUTE flag will be displayed.
- Press **MUTE** again on the remote control or increase the **VOLUME** to switch on the sound.

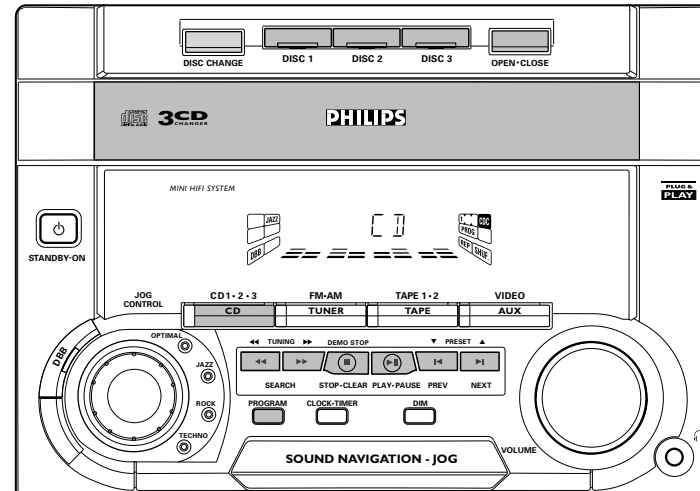

Warning!

- 1) This system is designed for conventional discs. Do not use any accessories such as disc stabilizer rings or disc treatment sheets, etc., which may damage the disc mechanism.
- 2) Do not load more than one disc into each tray.
- 3) When the CD changer is loaded with discs, do not turn over or shake the system. This may jam the changer.

You may load three discs in the CD changer for continuous playback without interruption.

Discs for playback

This system can play all digital audio CD, finalized digital audio CD-Recordable and finalized digital audio CD-Rewritable format discs.



Loading the CD Changer

- 1 Press **CD** to select CD mode.
- 2 Press **OPEN•CLOSE**.
→ The CD changer tray slides out.
- 3 Load a disc with the printed side up in the right tray.
 - You can load another disc in the left tray.
 - To load the third disc, press the **DISC CHANGE** button.
→ The CD changer tray will rotate until the empty tray is ready for loading.
- 4 Press **OPEN•CLOSE** to close the CD changer tray.
→ The total number of tracks and the playing time of the selected disc appear on the display.

Note:

- To ensure good system performance, wait until the CD changer completely reads the disc(s) before proceeding.

Disc Direct Play

- You can play a disc directly by pressing the **DISC 1**, **DISC 2** or **DISC 3** button. The CD player will stop at the end of playback of the selected disc.
 - A lit button indicates that a disc is loaded in the disc tray.
 - A flashing button indicates that a disc is playing.

Playing a Disc

- 1 Press **▶** to start playback.
 - The disc tray, track number and elapsed playing time of the current track appear on the display.
- To interrupt playback, press **||**.
→ The playing time flashes.
- To resume playback, press **▶** again.
- 2 To stop playback, press **■**.

Note:

- All the available discs will play once, then stop.

Disc Change

You can change the outer two discs while the third inner disc is stopped or is playing.

- 1 Press **DISC CHANGE**.
→ The CD changer tray slides out.
- 2 Replace the discs in the left and right disc trays.

- If you wish to change the inner disc during playback, press **DISC CHANGE** again.
 - "DISC CHANGE" will be displayed.
 - The disc will stop playing.
 - The CD changer tray will close to retrieve the inner disc and then open again with the inner disc accessible.
- 3 Press **OPEN•CLOSE** to close the CD changer tray.

Selecting a desired track

Selecting a desired track when playback is stopped

- 1 Press **◀** or **▶** until the desired track appears on the display.
- 2 Press **▶** to start playback.
 - The selected track number and elapsed playing time appear on the display.

Selecting a desired track during playback

- Press **◀** or **▶** until the desired track appears on the display.
 - The selected track number and elapsed playing time appear on the display.
- If you press **◀** once it will skip to the beginning of the current track and play the track again.

Note:

- Pressing **◀** during shuffling can only skip to the beginning of the current track.

Searching for a particular passage during playback

- Press and hold **◀◀** or **▶▶** until the desired passage is located.
 - The volume will be reduced.
- Play returns to normal when **◀◀** or **▶▶** is released.

Programming Tracks

Programming tracks of a loaded disc is possible when playback is stopped. The display will indicate the total tracks stored in the program. Up to 40 tracks can be stored in the memory in any order. When 40 tracks are stored and you attempt to store another track, the display will show "FULL".

- 1 Load the desired discs in the disc trays.
- 2 Press **PROGRAM** to start programming.
 - The **PROG** flag starts flashing.
- 3 Press the **CD (CD 1•2•3)** or **DISC 1/2/3** button to select the disc.
- 4 Press **◀** or **▶** to select the desired track.

- 5 Press **PROGRAM** to store the track.
- Repeat steps 3 to 5 to store other discs and tracks.
- 6 Press **■** once to end programming.
- The total number of tracks programmed and total playing time appear on the display.

Notes:

- If the total playing time is more than "99:59" or if one of the programmed tracks has a number greater than 30, then "--:--" appears on the display instead of the total playing time.
- If the system is reading the discs, programming is not possible, "READING" will be displayed and followed by "DISC X". "X" is the current read disc number.
- During programming, if no button is pressed within 20 seconds, the system will exit program mode automatically.
- "SELECT A DISC" will be displayed when programming an empty disc slot.

Reviewing the program

Reviewing of the program is possible only when playback is stopped.

- Press **◀** or **▶** repeatedly to review the programmed tracks.
- Press **■** to exit review mode.

Playing the program

- 1 Press **▶** to start program playback.
- "PLAY PROGRAM" will be displayed.
 - The track number and elapsed playing time of the current track will appear on the display.
- If you press **REPEAT** during program playback, the current track or all programmed tracks will be played repeatedly.
 - "TRACK" or "PROGRAM" will be displayed.
 - The **REP** and **PROG** flags appear on the display.

- 2 Press **■** to stop program playback.

Notes:

- If you press any of the **DISC DIRECT PLAY** buttons, the system will play the selected disc and the stored program will be ignored temporarily. The **PROG** display also will disappear temporarily from the display. It will reappear when playback of the selected disc ends.
- REPEAT DISC** mode will be cancelled when program playback begins.

Erasing the program (when playback is stopped)

- Press **■**.
 - "PROGRAM CLEAR" will be displayed.

Note:

- The program will be erased when the system is disconnected from the power supply or when the CD changer tray is opened.

Shuffle (only on remote control)

In shuffle mode, the system plays all the available discs and their tracks in random order. Shuffle may be used also when tracks are programmed.

To shuffle all the discs and tracks

- 1 Press **SHUFFLE**.
- "SHUFFLE" will be displayed.
 - The **SHUF** flag and the track selected at random appear on the display.
- The discs and the tracks will be played in random order until you press **■**.
 - If you press **REPEAT** during shuffling, the current track or all available discs will be played repeatedly.
 - "TRACK" or "ALL DISC" will be displayed.
 - The **REP** and **SHUF** flags appear on the display.
- 2 Press **SHUFFLE** again to resume normal playback.
- The **SHUF** flag disappears from the display.

Note:

- REPEAT DISC** mode will be cancelled when shuffle is selected.

Repeat (only on remote control)

You can play the current track, a disc or all available discs repeatedly.

- 1 Press **REPEAT** on the remote control to select the various repeat modes.
- "TRACK", "DISC", "ALL DISC" or "OFF" will be displayed.
 - The **REP** flag appears on the display.
- The selected track, selected disc or all available discs will now be played repeatedly until you press **■**.
- 2 Press **REPEAT** until the "OFF" mode is displayed to resume normal playback.
- The **REP** flag disappears from the display.

Notes:

- REPEAT DISC** mode is not available during program play or shuffle mode.
- You can also repeat shuffling a program.
 - "TRACK" or "PROGRAM" will be displayed.
 - The **REP**, **PROG**, and **SHUF** flags appear on the display.

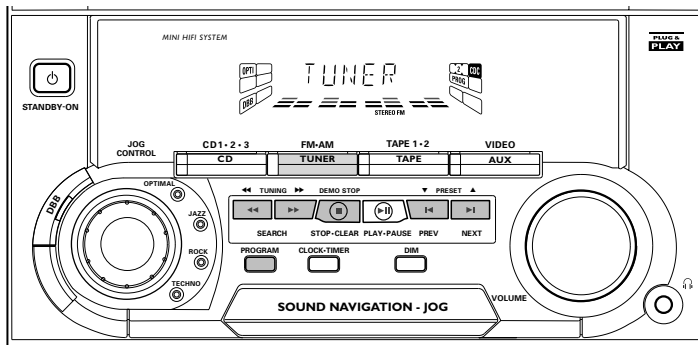
**Note:**

- For 'PLUG & PLAY' feature, please refer to page 12.

Tuning to radio stations

- 1 Press **TUNER** (FM•AM) to select TUNER mode.
 - "TUNER" will be displayed.
 - A few seconds later, the current radio frequency will be displayed.
 - 2 Press **TUNER** (FM•AM) again to select the desired waveband : FM or AM.
 - 3 Press ◀ or ▶ for more than one second, then release.
 - The display will show "SEARCH" until a radio station with sufficient signal strength is found.
- Repeat this procedure until the desired station is reached.

- To tune to a weak station, briefly press ◀ or ▶ repeatedly until the display shows the desired frequency and/or when the best reception has been obtained.

Storing Preset Stations

You can store up to 40 radio stations in the memory. When a preset radio station is selected, the preset number appears next to the frequency on the display.

Automatic programming

- 1 Press **TUNER** (FM•AM).
- 2 Press **PROGRAM** for more than one second.
 - The **PROG** flag starts flashing and "AUTO" will be displayed.

- The system will search for every available station in the FM waveband first, then search the AM waveband.
- All available stations will be stored automatically. The frequency and preset number will be displayed briefly.
- The system will stop searching when all the available radio stations are stored or when the memory for 40 preset radio stations is used.
- The system will remain tuned to the last stored preset radio station.

Notes:

- You can cancel the automatic programming by pressing **PROGRAM** or ■ (on the system only).
- If you want to reserve a section of preset numbers, for example preset numbers 1 to 9, select preset 10 before starting automatic programming, only the preset numbers 10 to 40 will be programmed.

Manual programming

- 1 Press **TUNER** (FM•AM).
- 2 Press **TUNER** (FM•AM) again to select the desired waveband : FM or AM.
- 3 Press **PROGRAM** for less than one second.

- The **PROG** flag starts flashing.
 - The next available preset number will be displayed for selection.
- 4 Press ◀ or ▶ to tune to the desired frequency.
 - If you wish to store the radio station to another preset number, press ▼ or ▲ to select the desired preset number.
 - 5 Press **PROGRAM** again.
 - The **PROG** flag disappears and the radio station will be stored.
 - Repeat **steps 3 – 5** to store other preset radio stations.

Notes:

- When 40 radio stations are stored and you attempt to store another radio station, the display will show "FULL". If you want to change an existing preset number, repeat steps 3 – 5.
- You can cancel manual programming by pressing ■ (on the system only).
- During programming, if no button is pressed within 20 seconds, the system will exit program mode automatically.

Tuning to Preset Radio Stations

- Press ▼ or ▲ to select the desired preset number.
 - The preset number, radio frequency, and waveband appear on the display.

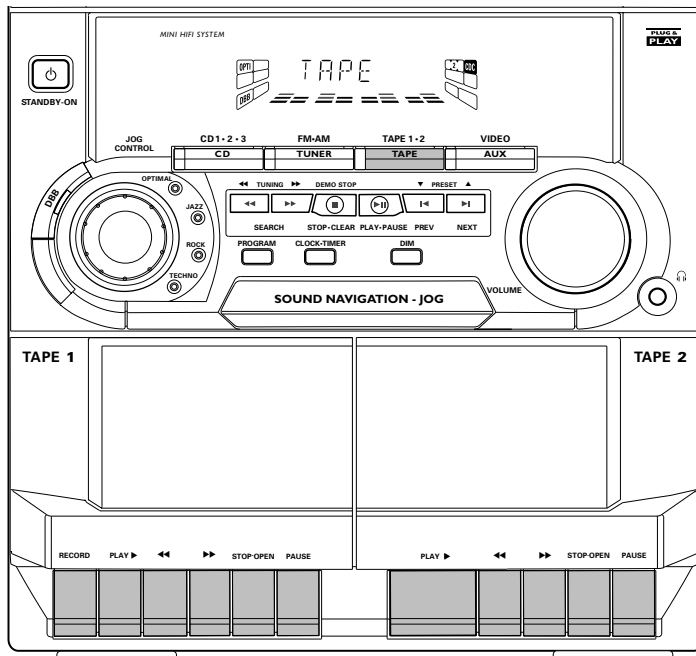

Loading a tape

- 1 Press **STOP•OPEN**.
- 2 The tape deck door opens.
- 3 Load the tape with the open side downward and the full spool to the left.

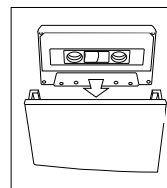

- 4 Close the tape deck door.

Tape Playback

- 1 Press **TAPE** to select TAPE mode.
→ "TAPE" will be displayed.
- 2 Load the tape into the selected tape deck.
- 3 Press **PLAY ▶** to start playback.
 - To interrupt playback, press **PAUSE**.
 - To resume playback, press **PAUSE** again.
- 4 Press **STOP•OPEN** to end playback.

Rewind/Fast Forward

When playback is stopped

- 1 You can rewind or fast forward a tape by pressing **◀◀** or **▶▶**, respectively.
→ The tape will stop automatically at the end of rewinding or fast forwarding.
- 2 Press **STOP•OPEN** to stop rewinding or fast forwarding.

Continuous Playback From Tape Deck 2 to Tape Deck 1

- 1 Press **TAPE** to select TAPE mode.
- 2 Load the tapes in tape deck 1 and 2.
- 3 Press **PLAY ▶** on tape deck 2.
- 4 Press **PAUSE** on tape deck 1.
- 5 Press **PLAY ▶** on tape deck 1.
→ Playback will begin with tape deck 2 and will continue with tape deck 1 when playback on tape deck 2 ends.
- 6 Press **STOP•OPEN** if you want to stop playback before the end of the tape in tape deck 1 or tape deck 2.

Notes:

- During rewinding or fast forwarding of a tape, it is also possible to listen to another source (e.g. CD, TUNER or AUX).
- Before playing a tape, check and tighten slack tape with a pencil. Slack tape may get jammed or may burst in the mechanism.
- C-120 tape is extremely thin and is easily deformed or damaged. It is not recommended for use in this system.
- Store the tapes at room temperature and do not put them too close to a magnetic field (for example, a transformer, TV or speaker).

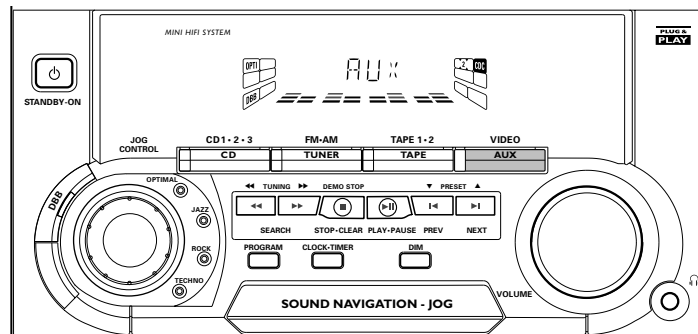

Selecting External Equipment

If you have connected the audio out terminals of the external equipment (TV, VCR, Laser Disc player, DVD player or CD Recorder) to the AUX IN terminals, you can hear the enhanced sound from the system.

- Press **AUX** to select the external equipment.
→ "AUX" will be displayed.

Note:

- All the sound control features (e.g. DSC, DBB, etc.) are available for selection.

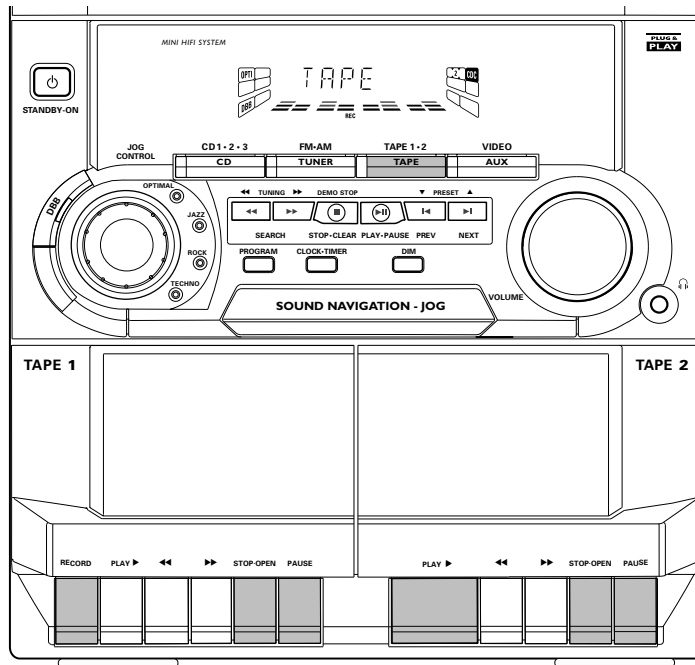

Notes:

- For recording, use only tape of IEC type I (normal tape).
- The tape is secured at both ends with leader tape. At the beginning and end of tape, nothing will be recorded for six to seven seconds.
- The recording level is set automatically, regardless of the position of Volume, DBB or DSC.
- To prevent accidental recording, break out the tab on the left shoulder of the tape side you want to protect.

One Touch Recording

- For One Touch Recording, as soon as you press RECORD, the current source (CD, TUNER or AUX) will be recorded on tape deck 1.

- 1 Load a blank tape in tape deck 1.
- 2 Press **RECORD** on tape deck 1 to start recording.
→ The **REC** starts flashing.
- 3 Press **PAUSE** to interrupt recording.
- 4 Press **STOP-OPEN** on tape deck 1 to stop recording.

CD Synchro Start Recording

During CD synchro start recording,

- Do not fast forward/rewind your tape in tape deck 2.

- 1 Load a blank tape into tape deck 1 and a disc into the disc tray.
- 2 Press **CD**.
 - You can program the tracks in the order you want them to be recorded (see Programming Tracks). If you do not, the tracks are recorded according to the order on the selected disc.
- 3 Press **RECORD** on tape deck 1 to start recording.
→ The **REC** starts flashing.
- 4 Press **STOP-OPEN** on tape deck 1 to stop recording, then press ■ to stop disc playback.

Dubbing tapes (from tape deck 2 to tape deck 1)

- 1 Load the prerecorded tape into tape deck 2 and a blank tape into tape deck 1.
 - Make sure both tapes have their full spool to the left.
- 2 Press **PAUSE** on tape deck 1.
 - Recording will start automatically.
- 3 Press **RECORD** on tape deck 1.
 - The **REC** starts flashing.
- 4 Press **PLAY ►** on tape deck 2.
 - Recording will start automatically.
- 5 Press **STOP•OPEN** on tape deck 1 and tape deck 2 to stop dubbing.

Notes:

- At the end of side A, flip the tapes to side B and repeat the procedure.
- Dubbing of tapes is only possible from tape deck 2 to tape deck 1.
- To ensure good dubbing, use tapes of the same length.

Recording from other sources (only on tape deck 1)

- 1 Load a blank tape into tape deck 1.
- 2 Press **CD, TUNER** or **AUX**.
 - Start playback of the selected source.
- 3 Press **RECORD** on tape deck 1 to start recording.
 - The **REC** starts flashing.
- 4 Press **PAUSE** to interrupt recording.
- 5 Press **STOP•OPEN** on tape deck 1 to stop recording.

Note:

- During recording, it is not possible to listen to another sound source.

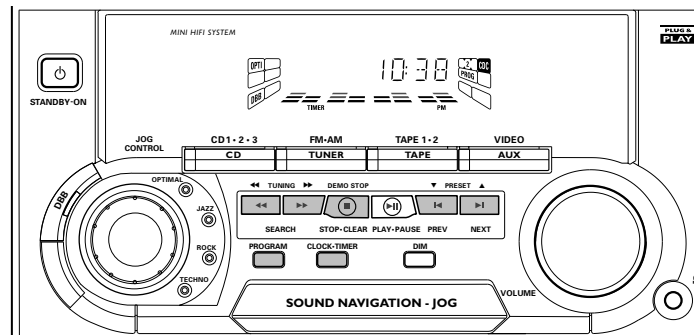

View Clock

You can view the clock (if it is set) if the system is in Standby mode or when any sound source is selected (CD, TUNER, etc.). The clock will be displayed for about seven seconds.

- Press **CLOCK•TIMER** briefly (on the system only).
 - "10:38 PM" or "22:38" (the current time) will be displayed depending on whether you have selected 12- or 24-hour mode.
 - "----" will be displayed if the clock is not set.

Clock Setting

The clock can be set in either 12- or 24-hour mode, e.g. "12:00 AM" or "00:00". Before setting the clock, you must be in the View Clock mode.

- 1 Press **CLOCK•TIMER** to select clock mode.
- 2 Press **PROGRAM** to select 12- and 24- hour mode.
 - If 12-hour mode is selected, "12:00" starts flashing and the **AM** lights up.
 - If 24-hour mode is selected, "00:00" starts flashing.
- 3 Set the hour with **<<** or **>>** on the system.
- 4 Set the minute with **◀** or **▶** on the system.

- 5 Press **CLOCK•TIMER** again to store the setting.
→ The clock starts.
- To exit without storing the setting, press **■** on the system.

Notes:

- During clock setting, if no button is pressed within 90 seconds, the system will exit clock setting mode automatically.
- When a power interruption occurs, the clock setting is erased.

Timer Setting

- The system can switch on to CD or TUNER mode automatically at a preset time. It can serve as an alarm to wake you up.
 - Before setting the timer, make sure the clock is set correctly.
 - The timer will always be switched on once it is set.
 - **The volume of the timer will increase from the minimum level to the most recently selected volume level.**
- 1 Press and hold **CLOCK•TIMER** for more than **two seconds** to select timer mode.

- “ 12:00 AM” or “00:00” or the last timer setting starts flashing depending on whether you have selected 12- or 24-hour mode.
- The **TIMER** starts flashing.
- The selected source is lit while other available sources are flashing.

- 2 Press **CD** or **TUNER** to select the desired source.
 - Before selecting CD, make sure a disc is loaded in the CD changer tray.
- 3 Press **◀** or **▶** on the system to set the hour for the timer to start.
- 4 Press **◀** or **▶** on the system to set the minute for the timer to start.
- 5 Press **CLOCK•TIMER** to store the start time.
 - The timer is now set.
 - The **TIMER** remains on the display.
 - At the preset time, the timer will be activated.
 - The selected source will be played.

Notes:

- During timer setting, if no button is pressed within 90 seconds, the system will exit timer setting mode automatically.
- If the source selected is TUNER, the last tuned frequency will be switched on.

- If the source selected is CD, playback will begin with the first track of the selected disc or program. If the CD trays are empty, the TUNER will be selected instead.
- The timer will not activate if a recording is in progress.

To switch off the TIMER

- 1 Press and hold **CLOCK•TIMER** for more than **two seconds**.
- 2 Press **■** on the system to cancel the timer.
 - The timer is now switched off.
 - The display will show “OFF” and the **TIMER** disappears.

To start the TIMER again (for the same preset time and source)

- 1 Press and hold **CLOCK•TIMER** for more than **two seconds**.
- 2 Press **CLOCK•TIMER** again to store the start time.
 - The timer is now on.
 - The **TIMER** appears on the display.

Sleep Timer (only on remote control)

This feature allows you to select a length of time after which the system will switch to the standby mode automatically.

- 1 Press **SLEEP** on the remote control repeatedly to select a period of time.
 - The selections are as follows (time in minutes): 15 → 30 → 45 → 60 → OFF → 15 ...
 - “SLEEP xx” or “OFF” will be displayed. “xx” is the time in minutes.
- 2 When you reach the desired length of time, stop pressing the **SLEEP** button.
 - The **SLEEP** display lights up.
 - The SleepTimer is now set. Before the system switches to standby mode, a countdown of 10 seconds will be displayed. “SLEEP 10” → “SLEEP 9” ... → “SLEEP 1” → “SLEEP”

While SLEEP mode is activated

- Press **SLEEP** once to view the remaining length of time.
- Press **SLEEP** twice to change the pre-selected period of time.
 - The display will show the remaining time followed by the sequence of sleep timer options.

To switch off the Sleep Timer

- Press **SLEEP** repeatedly until “OFF” is displayed, or press the **STANDBY-ON** button.

Specifications**AMPLIFIER**

Output power 2 × 30 W RMS ⁽¹⁾ / 2 × 25 W FTC ⁽¹⁾
Total power 60 W
Signal-to-noise ratio ≥ 67 dBA (IEC)
Frequency response 50 – 15,000 Hz, ± 3dB
Input sensitivity	
AUX In 700 mV
Output	
Speakers ≥ 6 Ω
Headphones 32 Ω – 1000 Ω

(1) (6 Ω, 1 kHz, 10% THD)

CD PLAYER

Number of programmable tracks 40
Frequency response 20 – 20,000 Hz
Signal-to-noise ratio ≥ 80 dBA
Channel separation ≥ 60 dB (1 kHz)
Total harmonic distortion < 0.003%

TUNER

FM wave range 87.5 – 108 MHz
AM wave range 530 – 1700 kHz
Number of presets 40
Antenna	
FM 300 Ω dipole wire
AM Loop antenna

TAPE DECK

Frequency response	
Normal tape (type I) 80 – 12,500 Hz (8 dB)
Signal-to-noise ratio	
Normal tape (type I) ≥ 48 dBA
Wow and flutter ≤ 0.4% DIN

SPEAKERS

System 2 way; double port bass reflex
Impedance 6 Ω
Woofer 1 × 5.5"
Dimensions (w × h × d) 8.27 × 12.20 × 9.25 (inch)
 210 × 310 × 235 (mm)
Weight 5.72 pounds each
 2.6 kg each

GENERAL INFORMATION

Material Polystyrene
AC Power 120 V / 60 Hz
Power Consumption	
Active 70 W
Standby < 15 W
Dimensions (w × h × d) 10.43 × 12.20 × 13.39 (inch)
 265 × 310 × 340 (mm)
Weight (without speakers) 13.35 pounds
 6.07 kg

Subject to modification

Maintenance

Cleaning the Cabinet

- Use a soft cloth slightly moistened with a mild detergent solution. Do not use a solution containing alcohol, spirits, ammonia or abrasives.

Cleaning Discs

- When a disc becomes dirty, clean it with a cleaning cloth. Wipe the disc from the center out.
- Do not use solvents such as benzene, thinner, commercially available cleaners, or antistatic spray intended for analog records.



Cleaning the CD lens

- After prolonged use, dirt or dust may accumulate at the CD lens. To ensure good playback quality, clean the CD lens with Philips CD Lens Cleaner or any commercially available cleaner. Follow the instructions supplied with cleaner.

Cleaning the Heads and the Tape Paths

- To ensure good recording and playback quality, clean the heads, the capstan(s), and pressure roller(s) after every 50 hours of tape operation.
- Use a cotton swab slightly moistened with cleaning fluid or alcohol.
- You can also clean the heads by playing a cleaning tape once.

Demagnetizing the heads

- Use a demagnetizing tape available at your dealer.

Warning! Under no circumstances should you try to repair the set yourself as this will invalidate the guarantee. Do not open the set as there is a risk of electric shock.

- If a fault occurs, check the points listed below before taking the system for repair.
- Should any problems persist after you have made these checks, consult your nearest dealer or service center.

CD Player Operation

“NO DISC” is displayed.

- The disc is inserted upside down.
 - Place CD with printed side up.
- Moisture condensation at the lens.
 - Wait until lens has adjusted to normal room temperature.
- There is no disc in the CD tray.
 - Insert a CD.
- The CD is dirty, badly scratched or warped.
 - Clean or replace the CD.
- The CD lens is dirty or dusty.
 - See section under Maintenance (page 24).

“DISC NOT FINALIZED” is displayed.

- The CD-RW or CD-R disc is not properly recorded for use with a standard CD player.
 - Read the instruction booklet of your CD-Rewritable or CD-Recorder on how to finalize a recording.
- The CD is badly scratched or dirty.
 - Replace or clean CD.

Radio Reception

Poor radio reception.

- The signal is too weak.
 - Adjust the antenna.
 - Connect an external antenna for better reception.
- The TV or VCR is too close to the stereo system.
 - Separate the stereo system from the TV or VCR.

Tape Deck Operation

Recording or playback cannot be made or there is a decrease in audio level.

- Dirty tape heads, capstans or pressure rollers.
- See section on tape deck maintenance (page 24).
- Magnetic build-up in the record/playback head.
- Use demagnetizing tape.

General

System does not react when any button is pressed.

- Electrostatic discharge.
- Press **STANDBY-ON** to switch the system off. Remove the AC power plug from the wall outlet, then reconnect the power plug and switch on the system again.

No or poor sound.

- Volume is not turned up.
- Adjust **VOLUME**.
- The headphones are connected.
- Disconnect the headphones.
- Speakers are not connected or are connected wrongly.
- Check that the speakers are connected correctly.
- Make sure the stripped speaker wire is clamped.

Reversed left and right sound.

- Speakers are connected wrongly.
- Check the speaker connections and location.

Lack of bass sound or apparently imprecise physical location of musical instruments.

- Speakers are connected wrongly.
- Check the speaker connection for proper phasing, colored/black wires to colored/black terminals.

Remote control has no effect on the system.

- Wrong source is selected.
- Select the source (**CD**, **TUNER**, etc.) before pressing the function button, (**▶**, **◀**, **▶**, etc.).
- The distance to the system is too large.
- Reduce the distance.
- Batteries are inserted incorrectly.
- Insert the batteries with their polarities (+/- signs) as indicated.
- Batteries are exhausted.
- Replace the batteries.

Timer is not working.

- Clock is not set.
- Set the clock.
- Timer is not switched on.
- Press **CLOCK•TIMER** to switch on the timer.
- Recording or dubbing is in progress.
- Stop recording.

Clock setting is erased.

- There was a power failure.
- Reset the clock.

System displays features automatically.

- Demonstration mode is switched on.
- Press and hold **■** (on the system) for five seconds to switch off the demonstration.

All lighted buttons are not lit.

- Display is switch on in DIM 3 mode.
- Press **DIM** until **DIM OFF** display mode is shown.

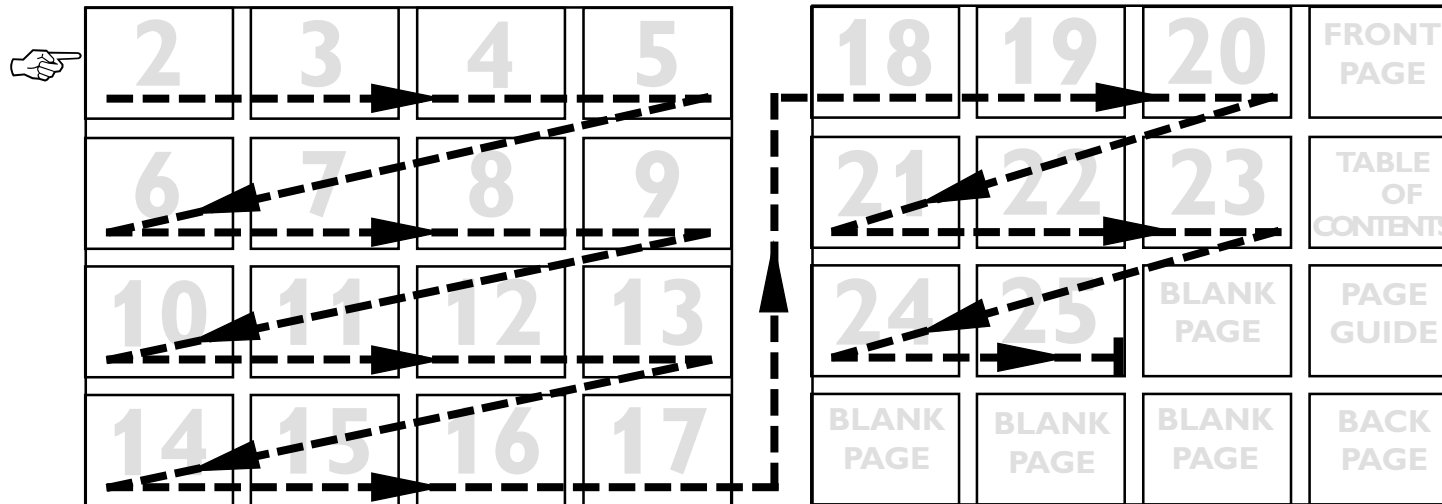

TABLE OF CONTENTS

President Message	2 - 3	AUX	19
Important Safety Instructions	4	Recording	20 - 21
Limited Warranty	5	Clock	21
Model Illustration	6	Timer	22
General Information.....	7	Sleep Timer	22
Safety Information	7	Specifications.....	23
Preparation	8 - 9	Maintenance.....	24
Controls.....	10 - 12	Troubleshooting	24 - 25
Operating The System	12 - 14		
CD.....	14 - 16		
Tuner	17		
Tape	18 - 19		



PAGE GUIDE





English

FW-C250

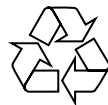

Philips Consumer Electronics Company

A Division of Philips Electronics North America Corporation, Knoxville, Tennessee 37914-1810, USA

3139 115 20353 (ENG)
IB8246T001

Printed In China

SL-0041/37-3

