

Lanzar®

Multi Media Mobile Audio System

SVDVD28

OPERATIONAL MANUAL

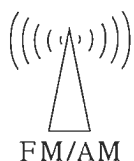

OPERATIONAL MANUAL

Welcome!

Thank you for buying this multi-media mobile audio system!

To operate the system correctly, please read the operational manual carefully before using the unit. Keep these instructions and retain this booklet for future reference.

About This Manual

This unit features a number of sophisticated functions ensuring superior operation. All the functions have been designed for the easiest possible use, but many are not self-explanatory. This manual will help you understand the functions and operations of the unit. This manual mainly explains **remote control operation**. However, in addition to those functions related with DVD/VCD/CD/MP3 operation that can only be operated by the remote control, there are also functions that can be operated by the buttons provided for the main unit.

OPERATIONAL MANUAL

CONTENTS





Notes on Installation	4
Precautions	5
Wiring Connections	6
Location of Controls	7
Location of Card Remote Control	8
Basic Operation	11
Listening to the Radio	14
Playing a DVD	17
Playing a MP3	32
Playing a VCD, CD	36
Maintenance	41
Install & Detach the Front Panel	43
Install & Detach the Unit.....	44
Specification.....	46
Simple Troubleshooting Guide.....	47

Notes on Installation

- ☞ The unit is designed for 12VDC, negative ground operation system only. Before installing the unit, make sure your vehicle is connected to DC 12V negative ground system.
- ☞ Be sure to connect the color coded leads according to the diagram. Incorrect connections may cause the unit to malfunction or damage the vehicle's electrical system.
- ☞ Be sure to connect the speaker (-) leads to the speaker (-) terminal. Never connect the left and right channel speaker cables each other or to the vehicle body.
- ☞ Make sure all the connections are completely correct before turning on your unit.
- ☞ When replacing the fuse(s), the replacement must be of the same amperage as shown on the fuse holder.
- ☞ Do not block vents or radiator panels. Blocking them will cause heat to build up inside and may result in fire.
- ☞ After completing the installation and beginning to play the unit(including replacing the battery), please remove the front panel at first, and then press **RESET** button on the base with pointed object (such as ball-point pen) to set the unit to initial status.

Precautions

☞ This unit can play the following discs only:

Type of disc	Label on the disc	Recorded material	Size of disc
DVD		Sound and moving pictures	12cm
VCD	 	Sound and moving pictures	12cm
CD		Sound only	12cm
MP3		Sound only	12cm

NOTE: The unit is compatible with VCD1.0/2.0/3.0 version and DVCD disc.

☞ Do not attempt to modify the unit, modifying the unit may cause an accident.

☞ Stop the vehicle before carrying out any operation that could interfere with your driving.

☞ Do not work in extremely high or low temperature. Be sure the temperature inside the vehicle is between +60° C and -10° C before turning on your unit .

☞ To enjoy optimum sound and images while playing, handle the discs as follows:

——Handle the disc by its edge to keep the disc clean, and do not touch the surface.



——Do not use your CDs with paste residue or ink attached.



——Do not use CDs with labels or stickers attached, which may leave a sticky residue while beginning to peel off.

(Shown as the picture)

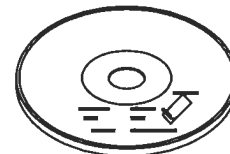

——Clean the discs with an optional cleaning cloth. Wipe each disc from the center out.

(Shown as the picture)

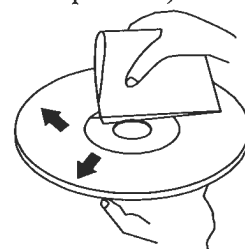

OPERATIONAL MANUAL

Wiring Connection

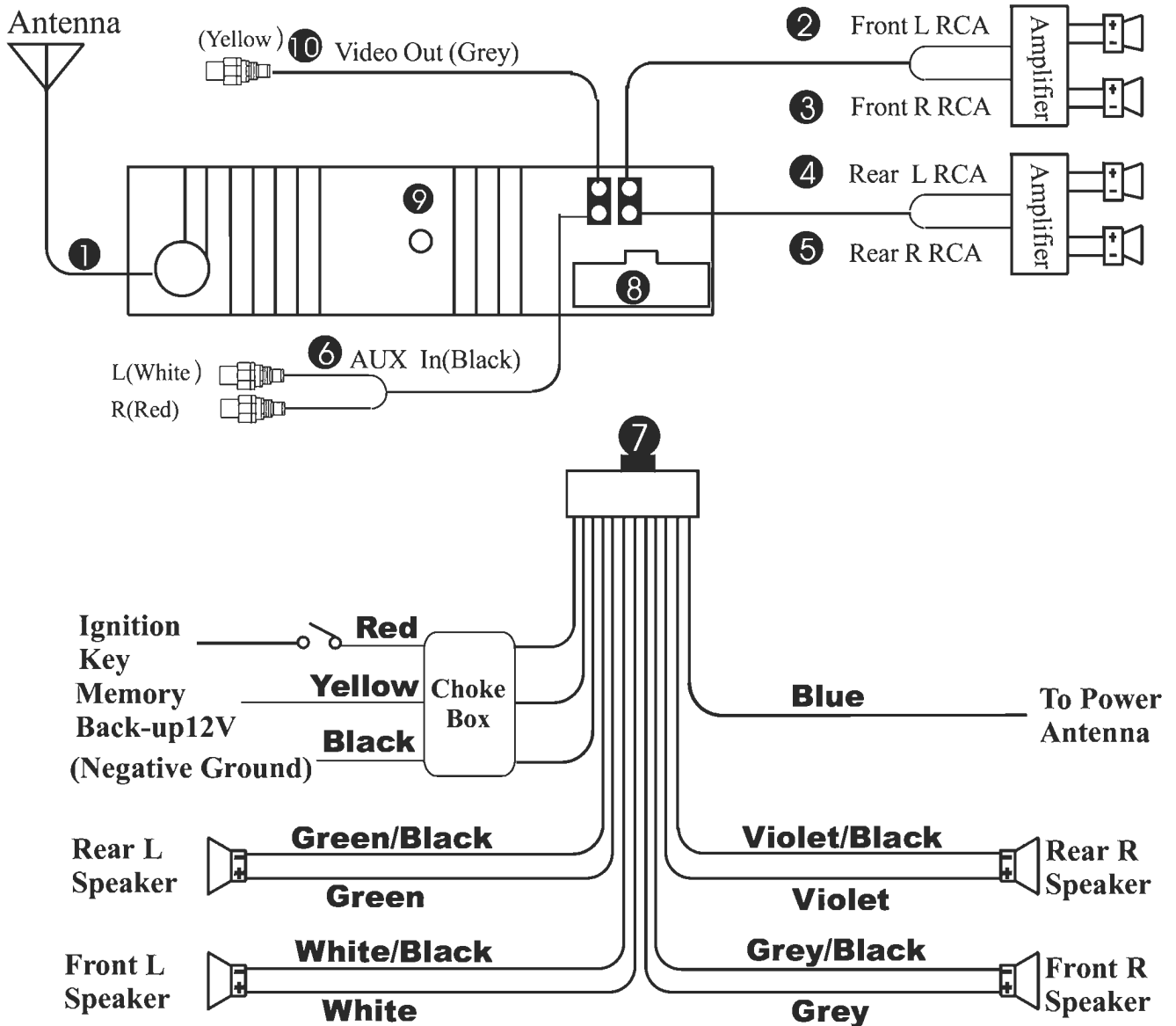

- | | |
|----------------------|--------------------------|
| ① Antenna Receptacle | ⑥ Aux In (Optional) |
| ② Front RCA (L) | ⑦ Output Plug (Male) |
| ③ Front RCA (R) | ⑧ Output Socket (Female) |
| ④ Rear RCA (L) | ⑨ Screw Holes |
| ⑤ Rear RCA (R) | ⑩ Video Out |

OPERATIONAL MANUAL

Location of the Controls

Front Panel

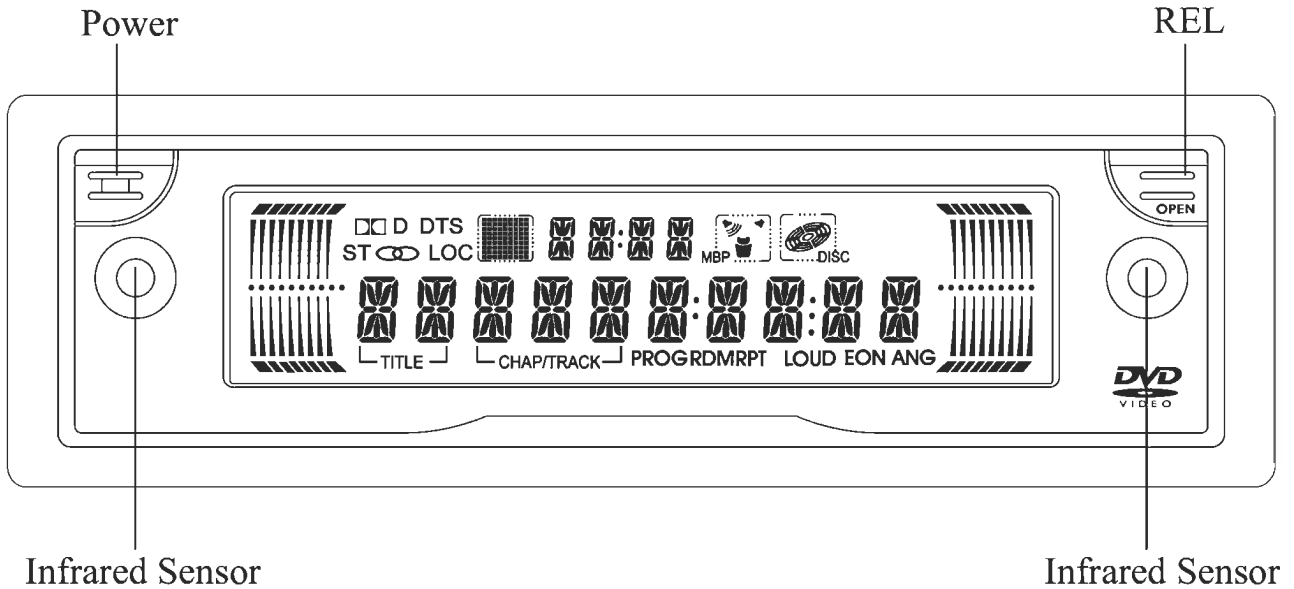

Base

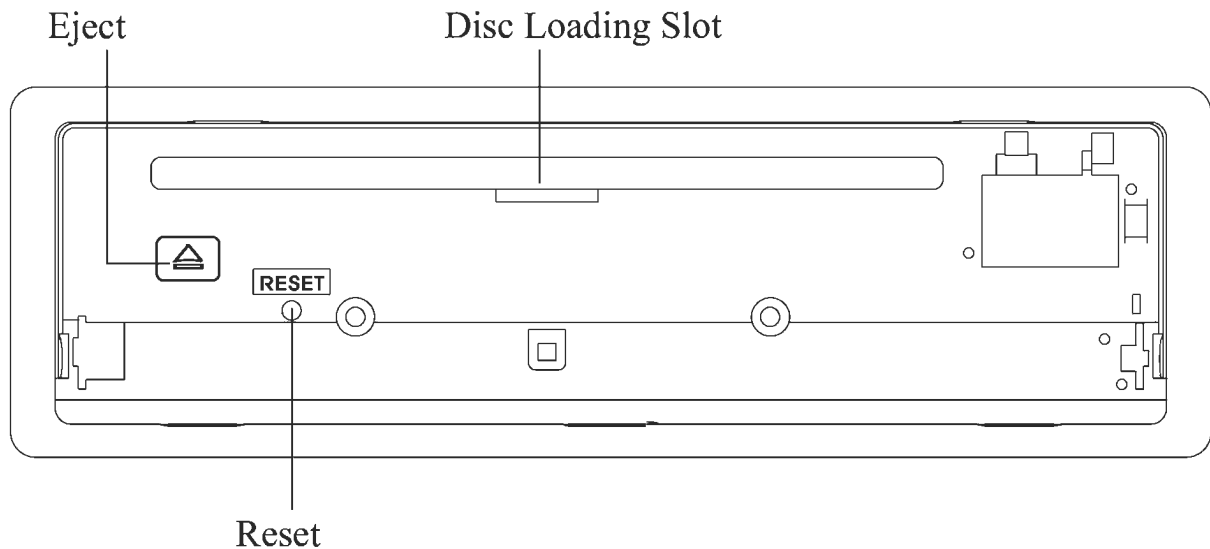

OPERATIONAL MANUAL

Card Remote Control

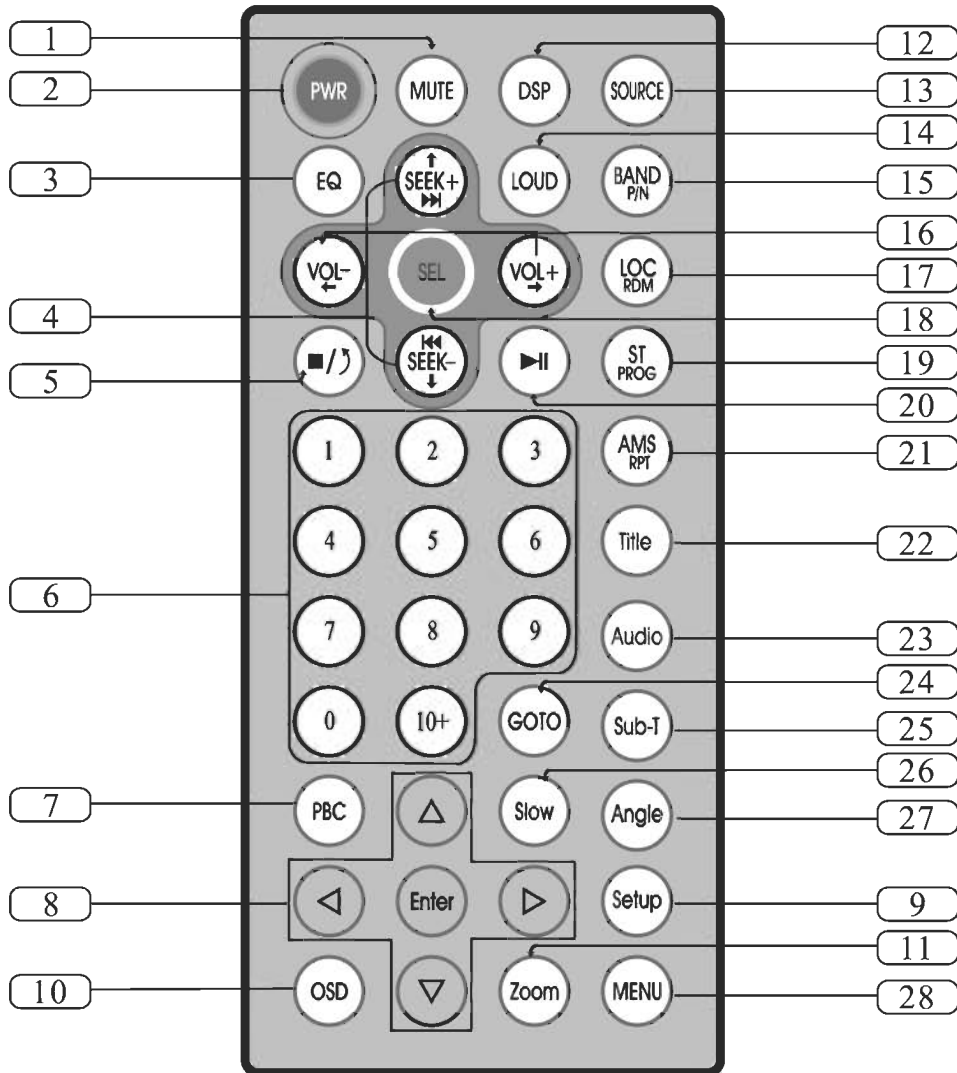

Tips:

For more information as to replacing battery, please refer to “Replacing the Battery” on page 41 .

OPERATIONAL MANUAL

- 1** MUTE
Press to shut off the sound output, press it again to resume previous sound level.
- 2** PWR
Press to turn on or off the unit.
- 3** EQ
Press to select the corresponding preset modes to adjust the sound quality.
- 4** SEEK+/SEEK-
Press to do manual seek tuning and track search controls.
- 5** ■/⏏
Press to stop the playback.
- 6** (0-10+) Number Button
Press to select track, chapter, preset stations.
- 7** PBC
Press to display menus.
- 8** [△][▽][◀][▶][ENTER]
During DVD mode, press to move cursor upward, downward, leftward or rightward, and then press [ENTER] to execute the entering or the selected item in the system setting menu.
- 9** SETUP
During playback mode, press to display system setting picture, the user can select some relative constant parameters.
- 10** OSD
Press to display title, chapter, the elapsed time, remain time.
- 11** ZOOM
Press to increase or decrease the picture in size.
- 12** DSP
Press to display current time.
- 13** SOURCE
Press to select your desired modes.
- 14** LOUD/MBP
Briefly press to activate LOUD function.
Press and hold this button for 3 seconds to activate MBP function.
- 15** BAND/ (P/N)
During radio mode, press to select bands. press and hold this button to change the FM between USA and Europe.
During DVD, VCD status, press to select PAL or NTSC system.

OPERATIONAL MANUAL

- 16** VOL+/VOL-
Press to increase or decrease volume level.
- 17** LOC/RDM
During radio status, press to select local station or distance station; During VCD, CD status, press to play tracks at random order.
- 18** SEL
Repeatedly press to select modes.
- 19** ST/PROG
During radio status, press to select stereo or mono reception; During VCD, CD status, press to set the program order to play.
- 20** ►||
Press to switch sequentially between playback and pause play.
- 21** AMS/RPT
During radio status, press to scan and store station; During playback status, press to replay.
- 22** TITLE
During DVD status, repeatedly press to select different titles.
- 23** AUDIO
During DVD status, press to change the audio language.
- 24** GOTO
Press to set the playback time.
- 25** SUBTITLE
Press to change the subtitle language during DVD playback.
- 26** SLOW
Press to slow forward or slow reward.
- 27** ANGLE
Press to change the viewing angle during DVD playback.
- 28** MENU
Press to return to the root menu of the disc during DVD playback.

OPERATIONAL MANUAL

Basic Operation

1.Reset the Unit

Operating the unit for the first time or after replacing the car battery, you must reset the unit.

Remove the front panel at first, and then Press **RESET** button on the base with a pointed object, (such as a ball-point pen) to set the unit to initial status.

■ Note:

When some errors occur on the display, you can also press RESET button to resume to normal, and it will erase the clock setting and some memorized functions.

2.Turning the Unit On/Off

Press **(2) PWR** button to turn on the unit, press it again, the unit is still in the waiting status. When insert a disc, the unit will automatically start playing. Keep pressing it to turn off the unit completely.

■ Note:

After the unit is off, the volume level is memorized during the area between 10 and 30. If the volume level is set less than 10, it will resume to 10; if it is higher than 30, it will resume to 30; if it is between 10 and 30, it still stores in the status which you set.

3.Volume Control

Press **(16) VOL+** button to increase the sound level and press **(16) VOL-** button to decrease the sound level.

4.Setting the Sound Characteristics

Repeatedly press **(18) SEL** button to select the desired mode in the following order:



■ Note:

- * After selecting the desired mode, you can adjust the current level by pressing **(16) VOL** buttons.
- * If you don't adjust **(16) VOL** buttons within 5 seconds after selecting the desired mode, the unit will automatically return to the current mode being displayed.
- * when **P-EQ** mode is activated, press **(18) SEL** button to select modes, **BAS/TRE** are invalid. (Shown as below)



OPERATIONAL MANUAL

5. Turning Loudness On/Off /My Best Position(MBP)

- 1 Briefly press **[14]** **LOUD** button on the remote control to activate loud function. You can press this button to increase the low frequency, which can improve sensitivity for your ears. And “**LOUD**” appears. Press it again to shut down “**LOUD**” function.
- 2 Press and hold this button for more than 3 seconds to activate MBP function. If no passenger in the car, you can perform MBP function and enjoy optimum sound.

LCD	F Speaker		R Speaker	
	L	R	L	R
MBP-A	0	-4dB	-4dB	-8dB
MBP-B	-4dB	0	-8dB	-4dB
MBP-OFF	0	0	0	0

*Each time when you press and hold **[14]** **LOUD** button for 3 seconds, it will select the position as desired in the following order:*



The corresponding mode will appear on the display.

If accurately adjusting the volume level needed, please use SEL button. (Refer to “*Setting the Sound Characteristics*” on **Page 11** for more details)

■ Note:

- * When activate BAL and FAD (“*Setting the Sound Characteristics*” on **Page 11**), MBP mode will be turned off.

6.P-EQ Setting

While listening to the popular music, classic music or rock music, you can select the corresponding preset modes to adjust the sound quality perfectly by using **[3]** **EQ** button.

Repeatedly pressing **[3]** **EQ** button to choose the following modes in turn:



■ Note:

Bass mode and Treble mode return to initial settings when P-EQ system is on, “Bass” and “Treble” disappear.

OPERATIONAL MANUAL

7.Mute Function

Press **1** **MUTE** button to shut off the sound output. And “*MUTE*” appears on the LCD. Press it again to resume to previous volume level.

8.Displaying and Adjusting Time

1 **Displaying Time:** Press **12** **DSP** button and the current time is shown on the LCD, it will return to original status after 5 seconds.

2 **Adjusting Time:** Press and hold **12** **DSP** button until the two points in the middle of the clock stop blinking, and the “Hour” blinks, you can press **16** **VOL+** or **VOL-** buttons to adjust hours; and then press **18** **SEL** button, and the “Minute” blinks, you can press **16** **VOL+** or **VOL-** buttons to adjust the minutes.

9.Mode Selector

Press **13** **SOURCE** button to select radio mode or playback mode.

10.Sensor

Infrared Sensor:

Receptor for the card remote commander. (Shown as picture)

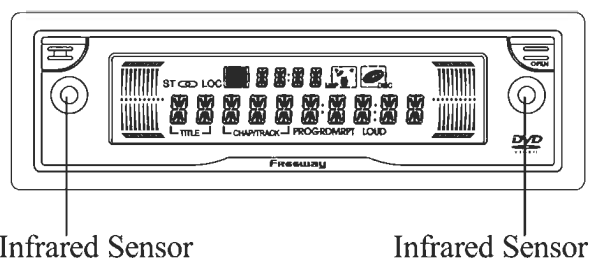

11.Aux In(Optional)

You can input the video frequency into the main unit to increase the volume through AUX.

OPERATIONAL MANUAL

Listening to the radio 1. Band Selector

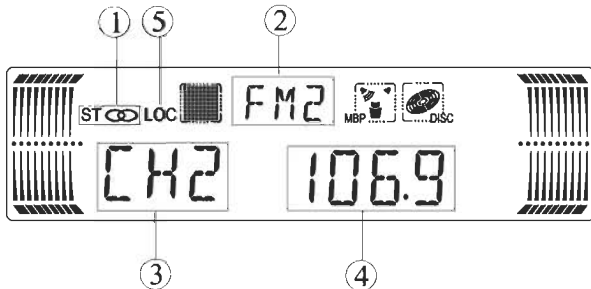

① Stereo (ST) Indicator

Shows that the frequency selected is being broadcast in stereo.

② Band Indicator

Shows which band the radio is tuned to AM or FM.

③ Preset Number Indicator

Shows what preset has been selected.

④ Frequency Indicator

Shows to which frequency the tuner is tuned.

⑤ LOC Indicator



Shows that the local station reception is being broadcasted.

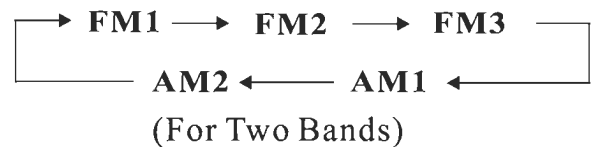

During radio status, repeatedly press  **BND or P/N** button on the card remote control to select bands in the following order:



2. Manual/Automatic Tuning

—During radio status,

① **Manual Tuning:** Press  ( or ) button on the remote control continuously to select a station downward or upward respectively.

② **Automatic Tuning:** Press and hold  ( or ) button for more than 3 seconds, the radio automatically searches a station downward or upward respectively and plays when it finds a station.

OPERATIONAL MANUAL

3. DX/LO Selector

During radio status, press **(17) LOC/RDM** button on the remote control to select strong or weak station reception.

- ① It is set to LOC mode when **(17)** **LOC/RDM** button is first pressed. “*LOC*” appears on the display and only local station is available.
- ② It is switched to DX mode when **(17) LOC/RDM** is pressed again. Both distance and local stations can be received.

■ Note:

- * The initial mode is DX mode.
- * LOC mode is functional only in selecting & memorizing stations.

4. MO/ST Selector

During radio status, you can press **(19) ST/PROG** button on the remote control to select **Mono** mode or **Stereo** mode.

- ① Stereo reception is charged when “*ST*” and “” appear.
- ② It is switched to **MONO** mode when “*ST*” disappear.

5. Scanning/Memorizing Stations Automatically

During radio status, you can press **(21)** **AMS/RPT** button on the remote control to scan each stored station 5 seconds respectively which stored in **(6)** **Number Buttons (from 1 to 6)**. You can press the corresponding **Number Buttons** or **AMS** button when your desired station is charged. And it starts playing that station.

When press and hold **(21)** **AMS/RPT** button for more than 3 seconds, it will activate automatically memory storing function. The radio automatically selects a station and has it stored in any one of the **(6)** **Number Buttons (from 1 to 6)**.

■ Note:

- * The unit can be stored up to 6 stations for each band.
- * Regarding the function of Number Buttons, refer to **6. Number Buttons** for more information.

6. Number Buttons

During radio status, **Number Buttons (from 1 to 6)** **(6)** can help you store your favorite station. You can follow the steps as below:

When receiving a station, press and hold any one of the **Number Buttons (from 1 to 6)** until “*CH*” appears on the **LCD**, which indicates that station is already stored in the corresponding number button.

You can store up to 18 FM stations (6 each for FM1, FM2, FM3), up to 12 AM stations (6 each for AM1/MW and AM2/LW).

Playing a DVD

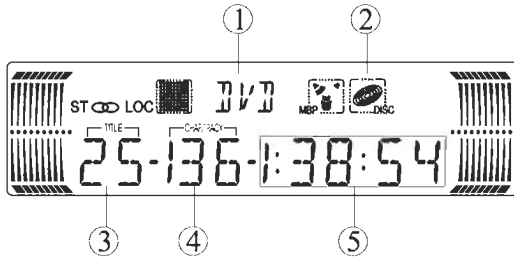

- ① **DVD Indicator**
Shows when a DVD disc is playing.
- ② **DISC Indicator**
Shows when a disc is playing.
- ③ **Title Number Indicator**
Shows the title currently playing.
- ④ **Chapter Number Indicator**
Shows the chapter currently playing.
- ⑤ **Play Time Indicator**
Shows the elapsed playing time of the current chapter.

1. Basic operation of DVD

(1) Press OPEN button on the head unit to open the front panel.

Disc loading slot appears.

(2) Insert a DVD disc into the slot, the unit will automatically switch on, if a DVD disc is loaded, press **13**

SOURCE on the remote control to start the playback.

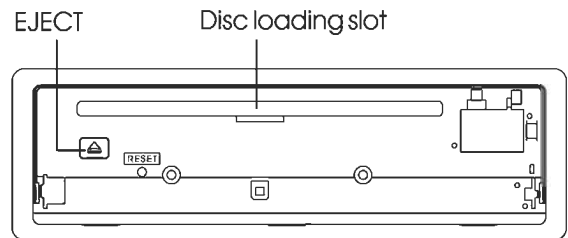

* You can eject a DVD by pressing **EJECT** button on the base.

* To avoid a malfunction, make sure that no metal object comes into contact with the front panel when the user opens the front panel.

(3) After a DVD disc has been inserted, close the front panel.

(4) Use the **VOL+/-** to adjust the sound level.

Press **VOL+** to increase the volume level, press **VOL-** to decrease the volume level.

OPERATIONAL MANUAL

2. Skip backward/forward /F.F/F.REW the playback

To skip back or forward to another chapter, press **[4]** (**⏮** or **⏭**).

Press and hold **[4]** (**⏮** or **⏭**) to perform fast reward or fast forward.

3. Stop the playback

Press **[5]** **■/⏸** to stop the playback.

4. Slow motion playback

Press **[26]** **SLOW** to slow forward or slow backward. There are 3 speeds each press decreases the speed until the minimum speed is reached.

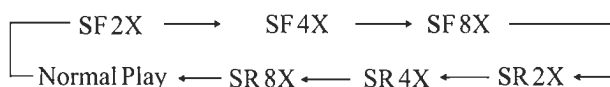

5. Increase the size of the picture

Press **[11]** **ZOOM** to increase the picture in size. There are 3 sizes, Each press increases the size until the maximum size is reached.

X1.5 → X2 → X3 → OFF

6. On-screen display

During DVD playback, press **[10]** **OSD**, the television shows: *total titles, total chapters, total elapsed time, remain time and the current chapter being played.*

7. Repeat Playing

During DVD playback, press  **AMS/RPT** on the remote control to perform replaying function when you need to repeat the track you like.

- 1 Firstly press  **AMS/RPT** button to repeat the current chapter being played. “**RPT**” appears on the LCD, TFT shows: “**CHAPTER REPEAT**”. Which indicates replaying one chapter starts.
- 2 Press it again to repeat the all titles on the disc. TFT shows: “**TITLE REPEAT**”.



8. Changing the viewing angle (Multi-angle)

With DVDs featuring multi-angle (scenes shot from multiple angles) recordings, you can press  **ANGLE** to switch among viewing angles during playback.

Selection options switch as follows:

ANGLE 1 — **ANGLE 2** — **ANGLE 3**

Notes:

- * This function only operates with DVD featuring multi-angle recordings.
- * The  mark on a DVD's package indicates it features multi-angle scenes. The number in the  mark indicates the number of angles from which scenes were shot.
- * You cannot switch angles during slow motion playback.
- * If you press ANGLE during fast forward/fast reverse or pause, fast forward/fast reverse or pause is canceled and normal playback resumes but the viewing angle does not change.

9.Changing audio language (Multi-audio)

DVDs can provide audio playback with different language. With DVDs featuring multi-audio recordings, you can press **23** **AUDIO** to switch between language and audio systems during playback.

Selection options switch as follows:

AUDIO 1 — AUDIO 2 — AUDIO 3

Notes:

- * This function only operates with DVD featuring multi-audio recordings.
- * The number in the “**2**” mark on a DVD's package indicates the number of recorded languages/audio systems.
- * During VCD, CD mode, you can press **AUDIO** to select left channel, right channel or stereo channel.

10.Changing the subtitle language (Multi-subtitle)

With DVDs featuring multi-subtitle recordings. You can press **25** **SUB-T** to switch between subtitle languages during playback.

Selection options switch as follows:

Subtitles 1 — Subtitles 2 — Subtitles OFF

Notes:

- * This function only operates with DVD featuring multi-subtitle recordings.
- * The number in the “**2**” mark on a DVD's package indicates the number of recorded subtitle languages.

OPERATIONAL MANUAL

11. Selecting different title (DVD mode)

- ① For DVD disc, if **PBC OFF**, you can press **22** **TITLE** to select different titles, and then press **6** **Number Buttons** on the remote control to select different chapter under the title chosen.
- ② If **PBC ON**, pressing **22** **TITLE** on the remote control to return the top menu of the disc, and you can select different chapter or title upward or downward by using **4** (**▶▶** or **◀◀**).

12. Selecting root menu (DVD mode)

- ① For DVD disc, if **PBC OFF**, you can press **28** **MENU** to select different root menus, and then press **8** **[Δ][▽][◀][▶][ENTER]** buttons to enter the sub-menus. With pressing **8** **[Δ][▽][◀][▶]** buttons, and **6** (**the number buttons**), and then **8** **ENTER** button to select and enter what you desired.
- ② If **PBC ON**, pressing **28** **MENU** to select different sub-menus. Press **8** **[Δ][▽][◀][▶]** buttons, then **6** (**the number buttons**), and then **8** **ENTER** button to select and enter what you desired.

13. SET UP MENU

During DVD playback, press **9** **SET UP**, the screen will display system setting picture, the user can select some relative constant parameters. The user also can set it as needed by moving the cursor and using **8** [**△**][**▽**][**◀**][**▶**] buttons, and then press **8** **ENTER** to execute the selecting or entering item.

■ Notes:

- * The selections are the preferred options that will be chosen if they are available on a disc. If the disc that is inserted does not have the preferred option then the discs own preference will be used.
- * Regarding SETUP MENU, please refer to the following pages for more details.
- * Some functions varies depending on the types of models or formats of the disc.

OPERATIONAL MANUAL

Set up General page

(Press setup, the screen will display system setting picture as follows:)

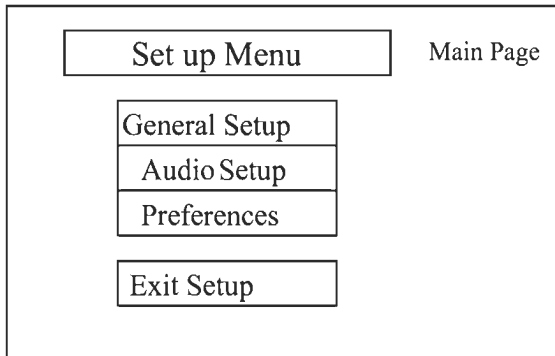

(Press Δ or ∇ , and then press ENTER)

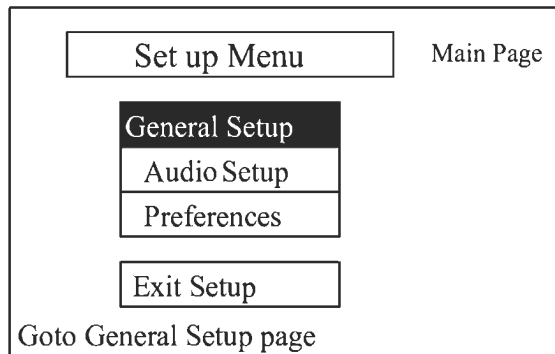

General Setup Menu appears

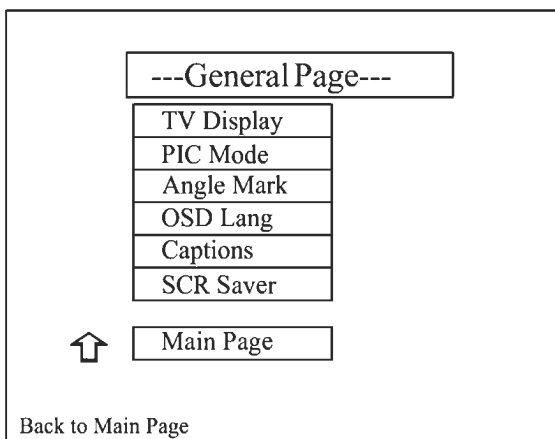

Set up Audio page

(Press setup, the screen will display system setting picture as follows:)

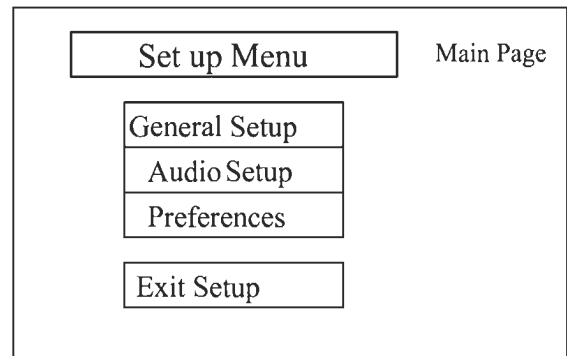

(Press Δ or ∇ , and then press ENTER)

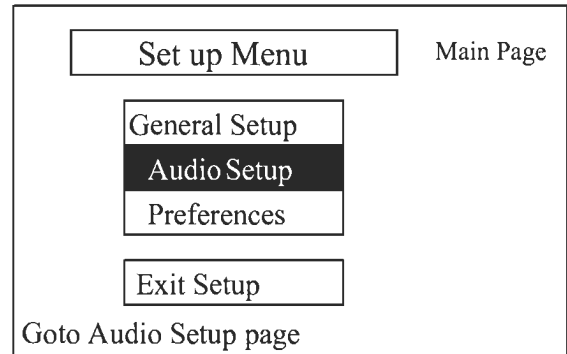

Audio Setup Menu appears

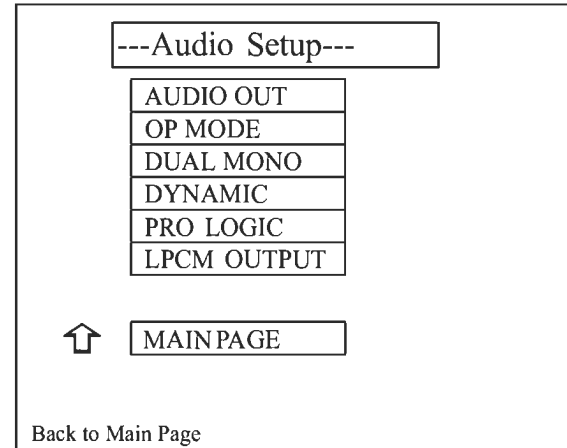

OPERATIONAL MANUAL

Set up Preferences page

(**Firstly press STOP**, and then Press setup, the screen will display system setting picture as follows:)

■ Note:
To access the Preferences setup menu, the disc must be in STOP mode.

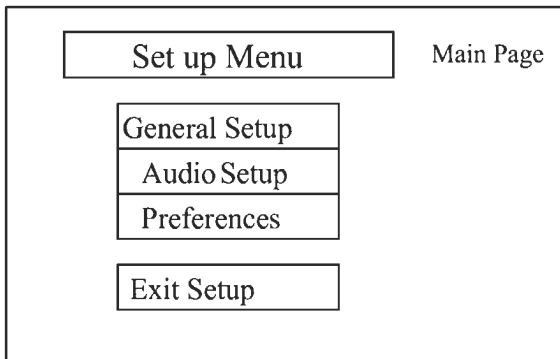

(Press Δ or ∇ , and then press ENTER)

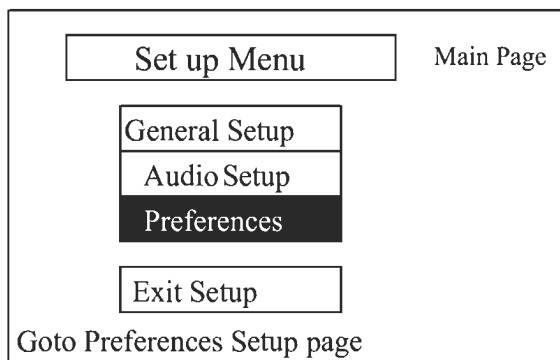

Preferences Menu appears

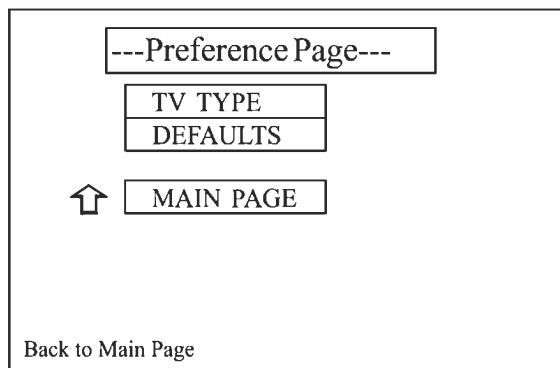

OPERATIONAL MANUAL

--- General page---

TV Display

Example showing how to set TV Display mode:

(1. Press Δ or ∇)

(2. Press \triangleright , Δ , ∇ and then press **ENTER**)

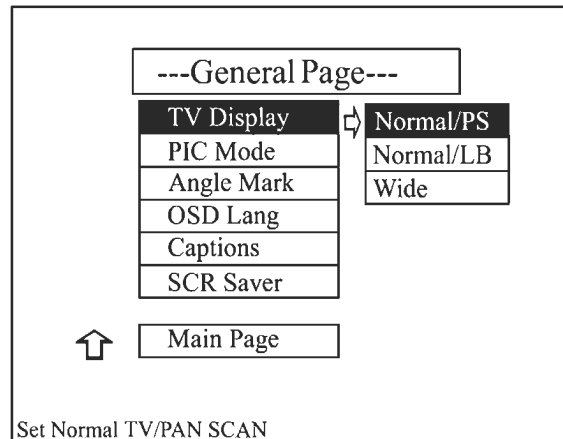
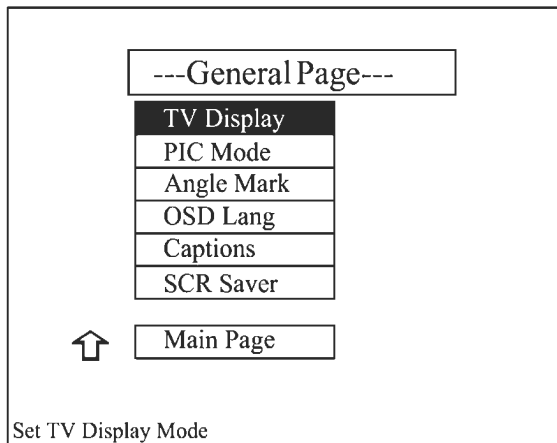

PIC Mode

Example showing how to set picture mode:

(1. Press Δ or ∇)

(2. Press \triangleright , Δ , ∇ and then press **ENTER**)

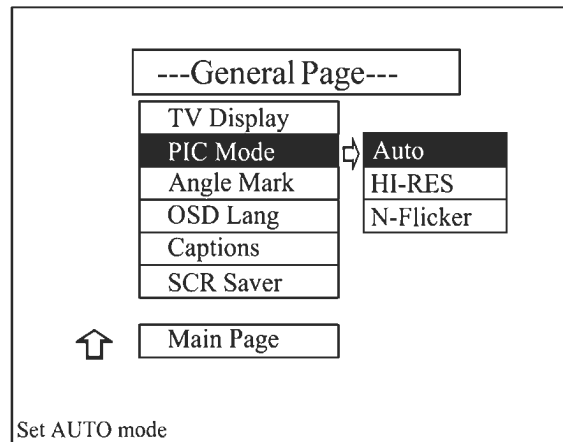
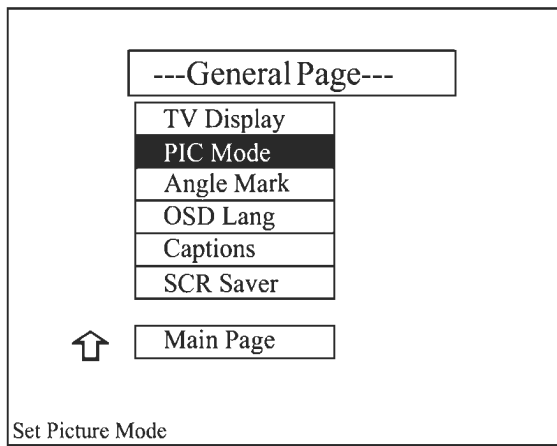

OPERATIONAL MANUAL

--- General page ---

Angle Mark

Example showing how to set Angle Mark On/Off:

(1. Press Δ or ∇)

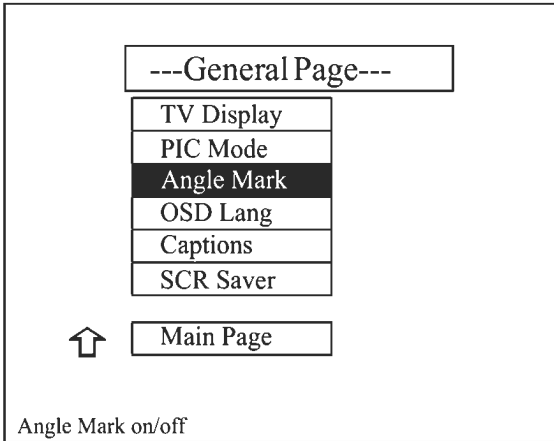

(2. Press \triangleright , Δ , ∇ and then press **ENTER**)

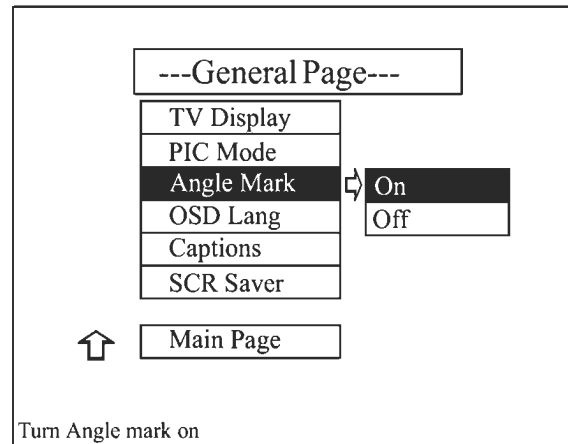

OSD Lang

Example showing how to set OSD Language:

(1. Press Δ or ∇)

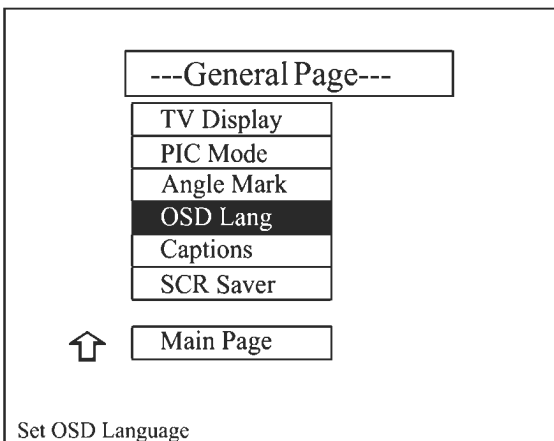

(2. Press \triangleright , Δ , ∇ and then press **ENTER**)

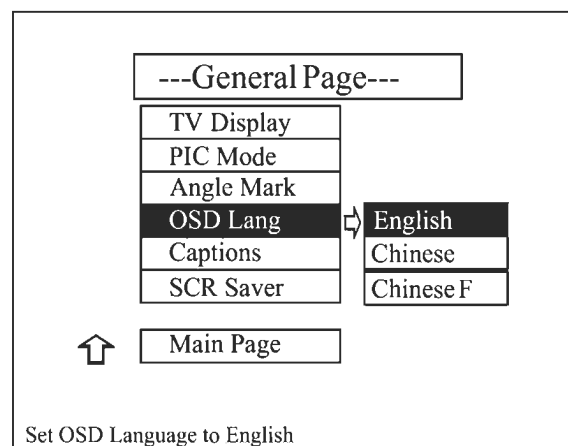

OPERATIONAL MANUAL

--- General page ---

Captions

Example showing how to set closed caption on/off:

(1. Press Δ or ∇)

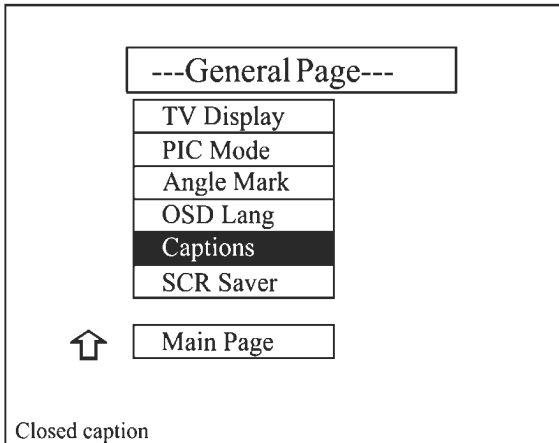

(2. Press \triangleright , Δ , ∇ and then press ENTER)

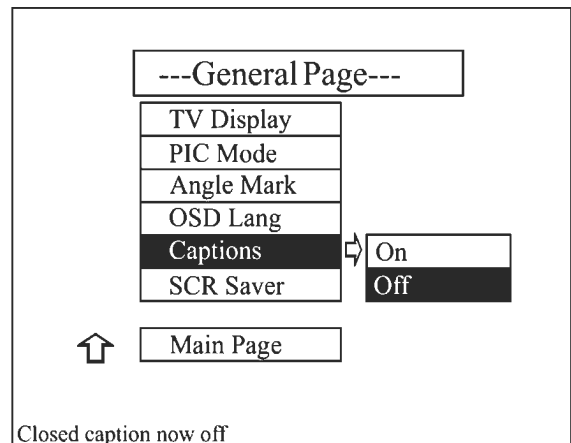

SCR Saver

Example showing how to set screen saver on/off:

(1. Press Δ or ∇)

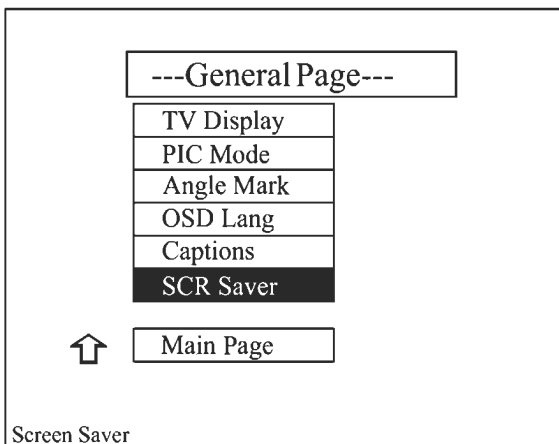

(2. Press \triangleright , Δ , ∇ and then press ENTER)

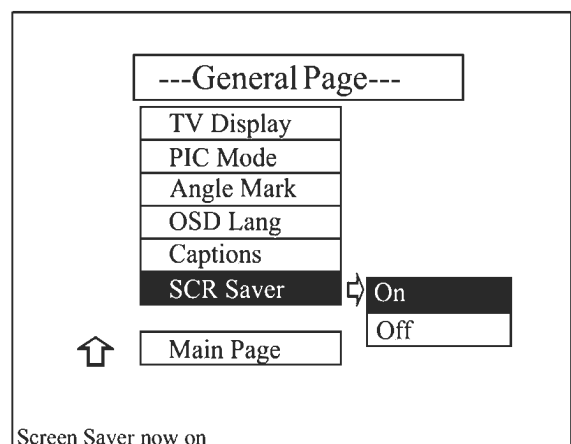

OPERATIONAL MANUAL

---Audio Setup page---

AUDIO OUT Example showing how to set audio output:

(1. Press Δ or ∇)

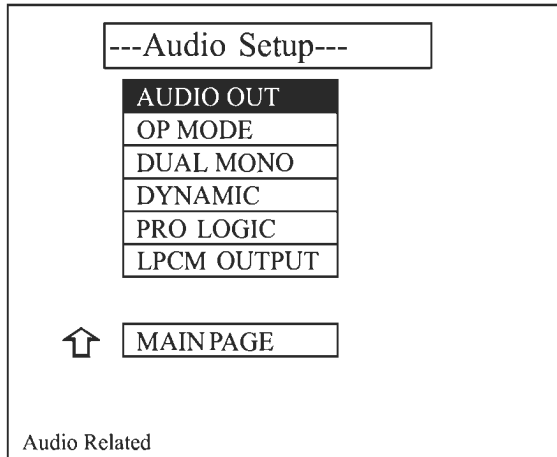

(2. Press \triangleright , Δ , ∇ and then press **ENTER**)

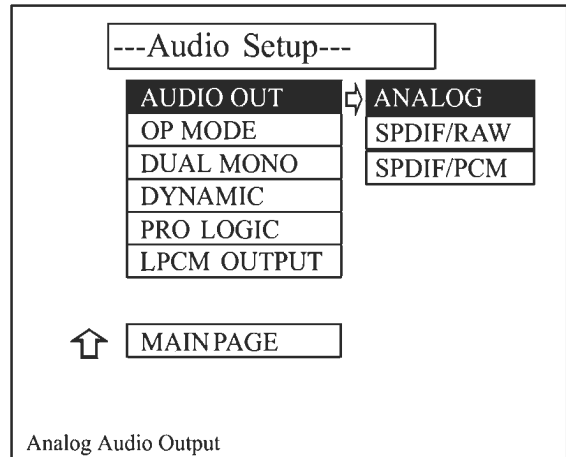

OP MODE Example showing how to set operational mode:

(1. Press Δ or ∇)

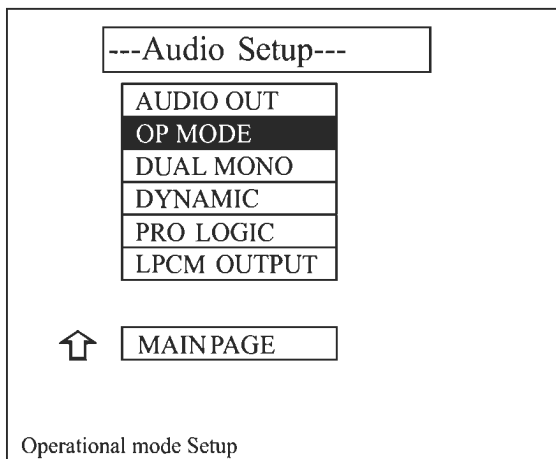

(2. Press \triangleright , Δ , ∇ and then press **ENTER**)

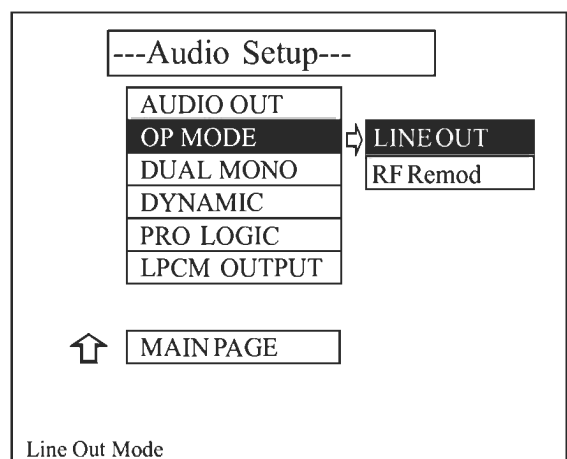

OPERATIONAL MANUAL

---Audio Setup page---

DUAL MONO

Example showing how to set stereo mode:

(1. Press Δ or ∇)

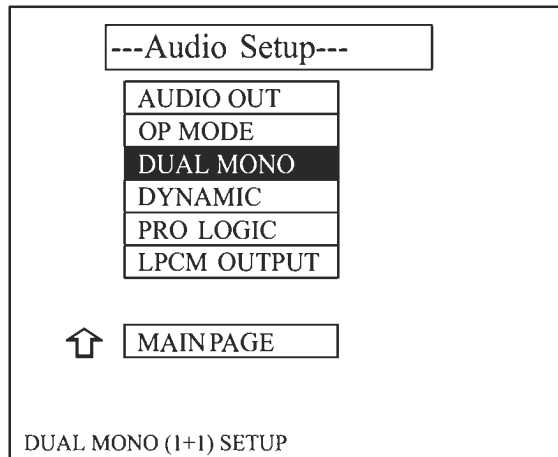

(2. Press \triangleright , Δ , ∇ and then press **ENTER**)

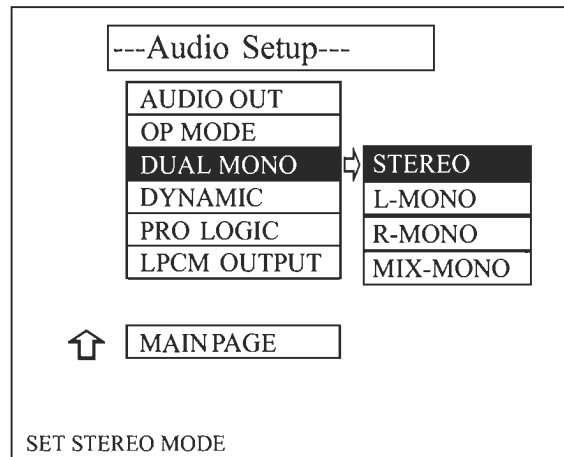

DYNAMIC

Example showing how to set dynamic range compression:

(1. Press Δ or ∇)

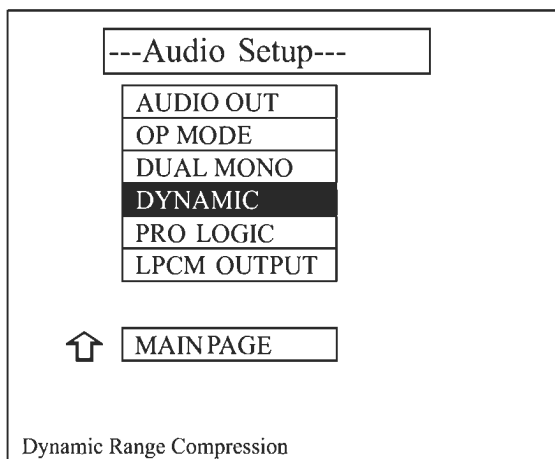

(2. Press \triangleright , Δ , ∇ and then press **ENTER**)

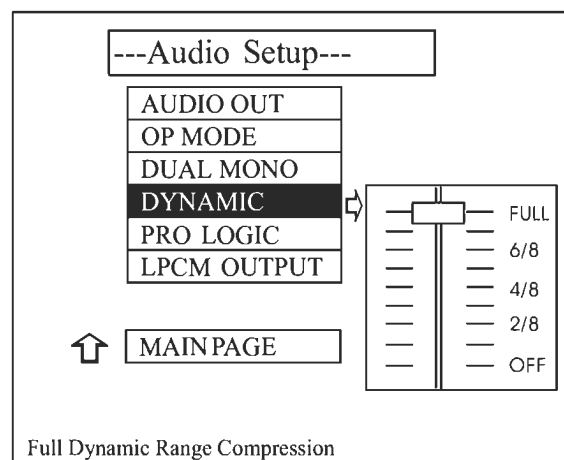

OPERATIONAL MANUAL

---Audio Setup page---

PRO LOGIC

Example showing how to set pro logic on/off:

(1. Press Δ or ∇)

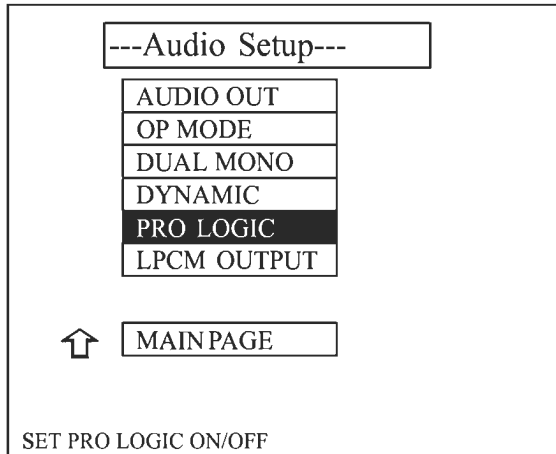

(2. Press \triangleright , Δ , ∇ and then press **ENTER**)

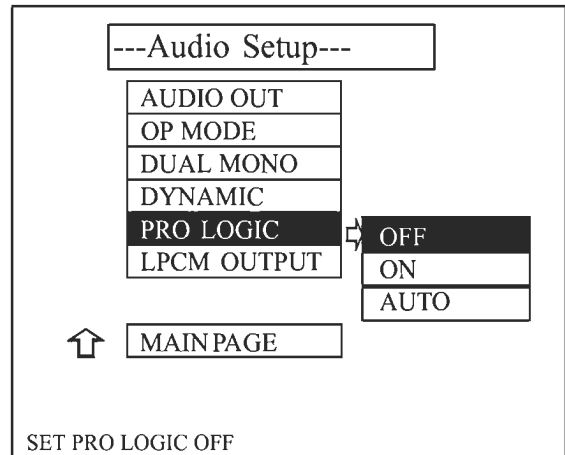

LPCM OUTPUT

Example showing how to set LPCM output to 48k or 96k:

(1. Press Δ or ∇)

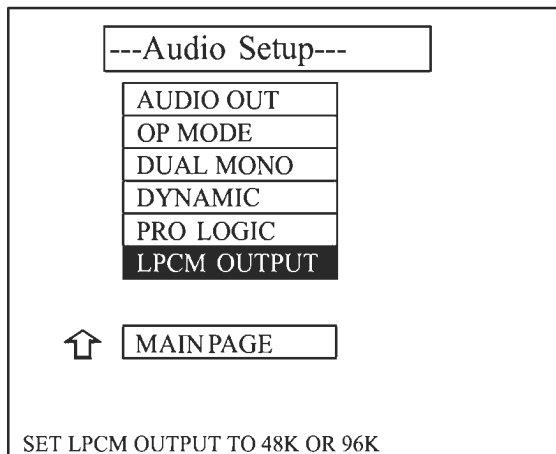

(2. Press \triangleright , Δ , ∇ and then press **ENTER**)

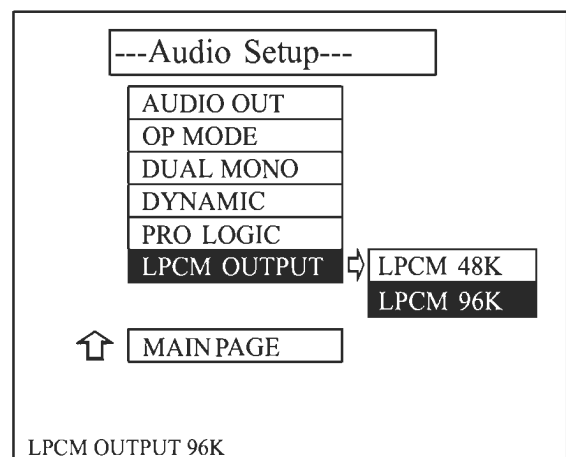

OPERATIONAL MANUAL

--- Preferences page---

TV Type

Example showing how to set TV type:

(1. Press Δ or ∇)

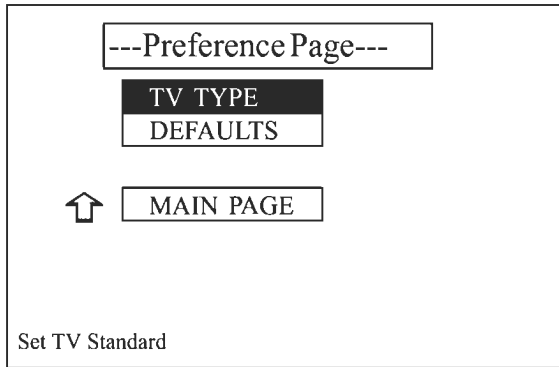

(2. Press \triangleright , Δ , ∇ and then press **ENTER**)

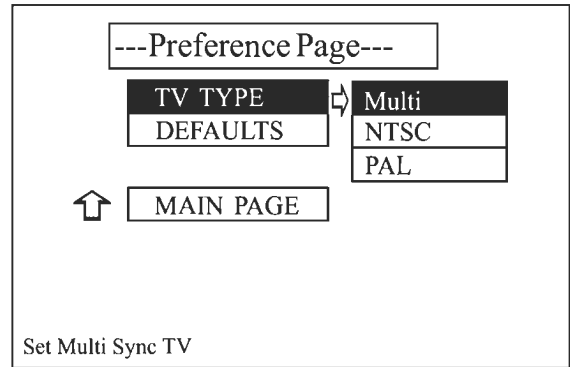

DEFAULTS

Example showing loading factory settings:

(1. Press Δ or ∇)

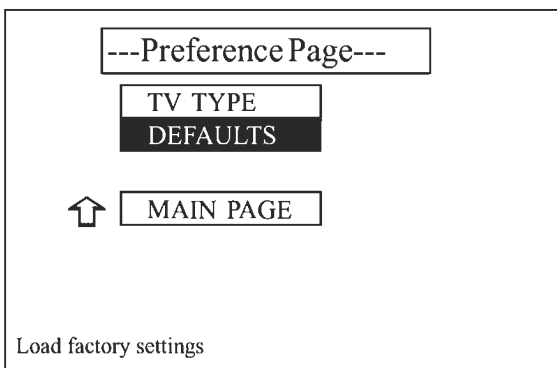

(2. Press \triangleright , Δ , ∇ and then press **ENTER**)

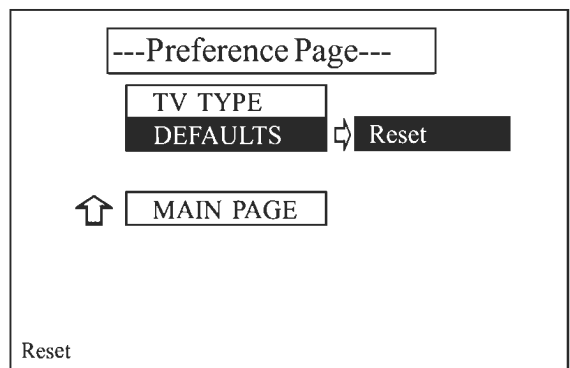

* The menu will return to Preference set up page.

Playing a MP3

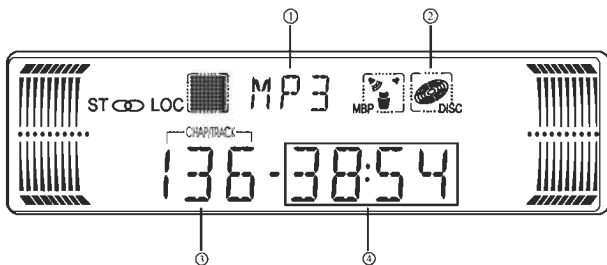

- ① **MP3 Indicator**
Shows when a MP3 disc is playing.
 - ② **DISC Indicator**
Shows when a disc is playing.
 - ③ **Track Number Indicator**
Shows the track currently playing.
 - ④ **Play Time Indicator**
Shows the elapsed playing time of the current track.
- * Shows WMA on the display when playing WMA. (As following picture)

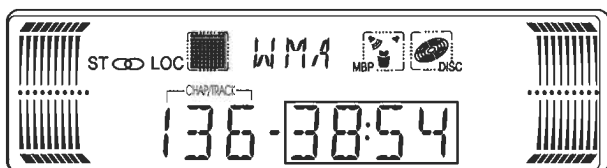

Note:
This function can only be operated on special machine.

1. Basic operation of MP3

(1) Press OPEN button on the head unit to open the front panel.

Disc loading slot appears.

(2) Insert a MP3 disc into the slot, the unit will automatically switch on, if a MP3 disc is loaded, press **13**

SOURCE on the remote control to start the playback.

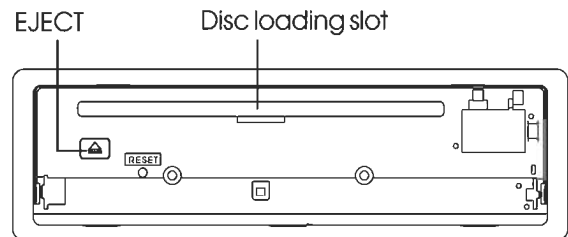

- * You can eject a MP3 disc by pressing **EJECT** on the base.
- * To avoid a malfunction, make sure that no metal object comes into contact with the front panel when the user opens the front panel.

(3) After a MP3 disc has been inserted, close the front panel.

(4) Use the **VOL+/-** to adjust the sound level.

Press **VOL+** to increase the volume level, press **VOL-** to decrease the volume level.

OPERATIONAL MANUAL

2. MP3 Menu Mode

* Put a MP3 disc, the TV screen will display the picture as following :

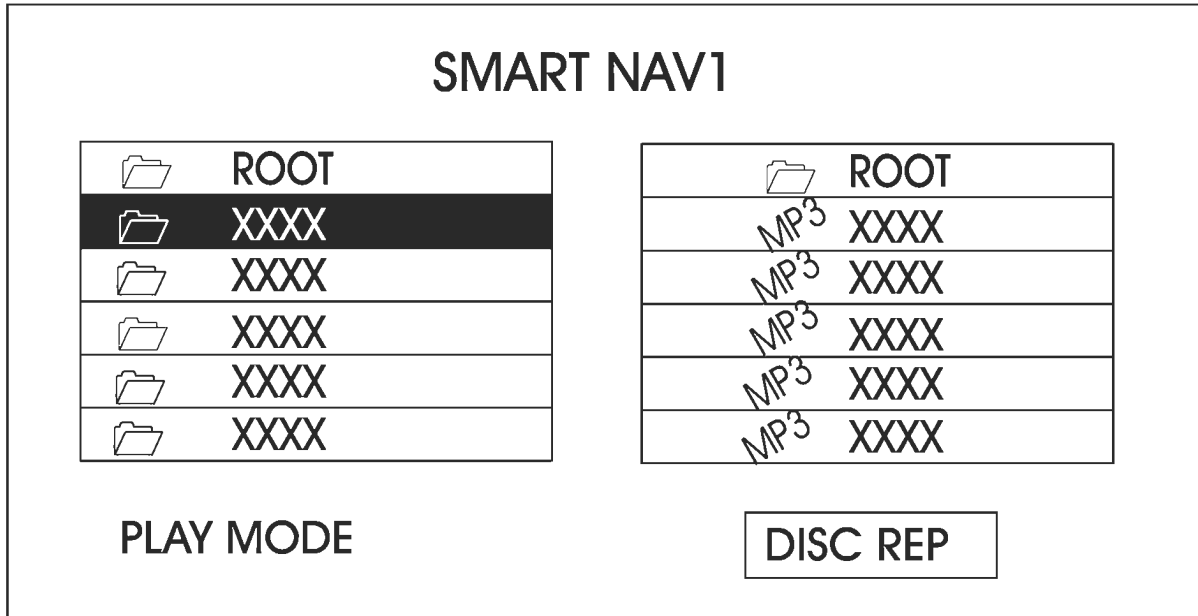

In this picture, the right menu is the left menu' s sub-menu; the down part is MP3 disc playing status. To select tracks on the right menu, you can press **6** [**Number Buttons**]. If you' d like to select director or tracks quickly, please press [**STOP**] firstly, then press **8** [**<**] [**>**] [**△**] [**▽**], and then press **8** [**ENTER**] button to enter what you do.

3. Selecting Tracks/ F.F/F.REW

- ① During MP3 playback, you can choose your favorite track by pressing (◀◀or▶▶) button on the remote control backward or forward respectively.
- ② Press and hold (◀◀or▶▶) button to fast rewind or fast forward for you to reach your desired track (or portion) quickly.

4. Repeat Playing

During MP3 playback , press

AMS/RPT to perform replaying function when you need to repeat the track you like.

- ① Firstly press **AMS/RPT** button to repeat all tracks on the disc. And the television appears .
- ② Press it again to repeat the current track being played. And appears on the television.
- ③ Press it at the third time to repeat the directory on the disc. And the television will show: .

Note:

The default setting is **Disc Repeat**.

5. Playing Tracks in Random Order

During MP3 playback status, when pressing **17** **LOC/RDM** button on the remote control, “**RANDOM PLAY**” will appear on the television, the unit plays any track at random under the directory which you select. Press **RDM** again to return to normal playing.

6. Stop Playing

During **MP3** status, press **5** **■/⏏** button to stop the playback, and the display shows “**STOP**”, and “” mark stops running. Press **▶||** button to revert to normal playback.

7. Pause the Playback

During MP3 playback, press **20** **▶||** button to suspend the playback, and the LCD shows: “**PAUSE**”. Press it again to return to normal playback.

8. On Screen Display

—During **MP3** status, press **10** **OSD** button on the card remote control, the display shows “*single track elapsed time, single track remain time*”

OPERATIONAL MANUAL

Playing a VCD/CD 1. Basic operation of VCD/CD

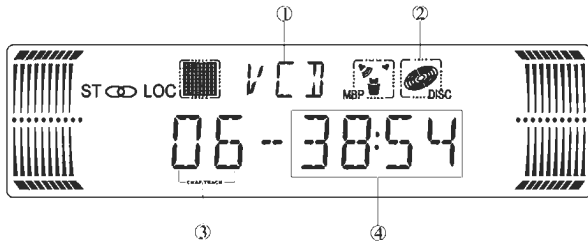

- ① **VCD, CD Indicator**
Shows when a VCD or CD disc is playing.
- ② **Disc Indicator**
Shows when a disc is playing.
- ③ **Track Number Indicator**
Shows the track currently playing.
- ④ **Play Time Indicator**
Shows the elapsed playing time of the current track.

(1) Press OPEN button on the head unit to open the front panel.

Disc loading slot appears.

(2) Insert a VCD or CD disc into the slot, the unit will automatically switch on, if a VCD or CD disc is loaded, press **13** **SOURCE** on the remote control to start the playback.

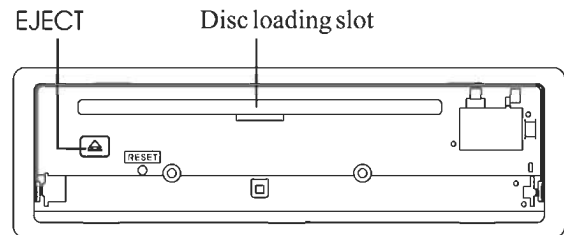

- * You can eject a VCD or CD disc by pressing **EJECT** on the base.
- * To avoid a malfunction, make sure that no metal object comes into contact with the front panel when the user opens the front panel.

(3) After a VCD or CD disc has been inserted, close the front panel.

(4) Use the **VOL+/-** to adjust the sound level.

Press **VOL+** to increase the volume level, press **VOL-** to decrease the volume level.

OPERATIONAL MANUAL

2. System Button

During playback status, press **[15]**

BAND/(P/N) button to set the TV standard to PAL or NTSC system.

■ Note:

It is functional only in DVD , VCD status.

3. Selecting Tracks/F.F/F.REW

- ① During VCD, CD playback, you can choose your favorite track by pressing **[4]** (**⏮** or **⏭**) button backward or forward respectively.
- ② Press and hold **[4]** (**⏮** or **⏭**) button to go fast rewind or fast forward for you to reach your desired track (portion) quickly.

4. Slow motion playback

During VCD playback, press **[26]**

SLOW to go slow forward. There are 3 speeds each press decreases the speed until the minimum speed is reached.

SF 1X → SF 2X → SF 3X → Normal Play

5. Increase the Size of the Picture

During VCD playback, press **[11]**

ZOOM to increase the picture in size.

There are 3 sizes. Each press increases the size until the maximum size is reached.

X1.5 → X2 → X3 → OFF

6. On Screen Display

—During VCD status,
press **[10]** **OSD** button on the card remote control, the display shows “*single track elapsed time, single track left time, the track being played and the amount of the whole disc*”

■ Note:

During MP3 status, only single track elapsed time & single remain time are displayed when pressing OSD button.

7. Setting CDs Playback Time

—During VCD, CD status, press **[24]** **GOTO** button to set the time when you begin playing the track, and the television will display the time: --:--. Enter your desired time by using **[6]** **(0~9) Number Buttons**. For example, enter: **25:00**, it will automatically starts playing the track from the point of twenty-fifth minutes in the disc.

■ **Note:**
During DVD status, press **[24]** **GOTO** button, TFT will display: -- : -- : --.

8. Number Button

During VCD, CD status, you can select any track directly by using **[6]** **Number Buttons(0~10+)**. For example, if you need the **15th** track, you can firstly press **Button 10+**, and then press **Button 5**, the corresponding track (**15th**) will be played.

■ **Note:**
When button 10+ is first pressed, it works as 10+, it works as 20+ when pressed at the second time, the third time...30+,... And the like.

9. Program Playing

—During VCD, CD status, you can set the program order to play.

You can follow the steps as below:

During VCD, CD playback, press **[19]** **ST/PROG** button, and the screen will show: **P00—00:00**, you can enter your desired track, (For example, the **5th** track, enter **05**; the **12th** track, enter **12**), and the unit will automatically turn to :

P02 : - - , P03 : - - ...and the like. (up to 99 tracks.) You can set program order by using **[6]** **(0~10) Number Button**. And then press **[20]** **▶||** button to play them. To stop program playing, press **[5]** **■/)** button.

10.Repeat Playing

Press **(21) AMS/RPT** to perform replaying function when you need to repeat the track you like.

- 1 Firstly press **(21) AMS/RPT** button to repeat the current track being played. “*RPT*” appears on the LCD. Which indicates replaying one track starts.
- 2 Press it again to release single track replaying function.





■ Note:

* The default setting is **Disc Repeat**.



11.Playing Tracks in Random Order

During VCD, CD status, when pressing **(17) LOC/RDM** button, “*RDM*” will appear on the display, the unit plays any track at random. Press it again to return to normal playing.





12. Stop Playing

During VCD, CD status, press   button on the remote control to stop the playback, and the display shows “*total tracks, total elapsed time of all the tracks on the disc*”, and “” mark stops running. Press  button to revert to normal playback.

13. Pause the Playback

During VCD, CD playing, press  () button to suspend the playback, LCD will show: “*PAUSE*”, Press it again to return to normal playback.

14. Playing PBC (Menu)

During VCD status, when pressing  **PBC** button on the card remote control at the first time, PBC playback starts and **the menu of entire disc** appears on the television. And then you can select your favorite track by using **Number Buttons**  (**0~10+**). When a track is playing, you can press   button to return to the menu if you would like to end the track and select others. To cancel PBC playing, press  **PBC** button again.



Note:

PBC playing confirms to version 2.0 of VCD/DVD disc only.

Maintenance

Replacing the Fuse

Make sure the amperage matches the specified value when replacing the fuses. If the fuse is blown, check the power connection and replace with a new one. If the same problem occurs, it would be subjected to the malfunction in-house. In such cases, please consult the nearest service dealer.

Warning

Never use the fuse with the rated amperage more than that supplied to your unit, otherwise it will damage the unit.

Replacing the Battery

When the range of the operation of the card remote control becomes short or no functions while operating. Replace the lithium battery with a new button cell (CR2025). Make sure the battery polarity before replace.

1. Gently pull out the Battery Holder while pressing the Stopper ①

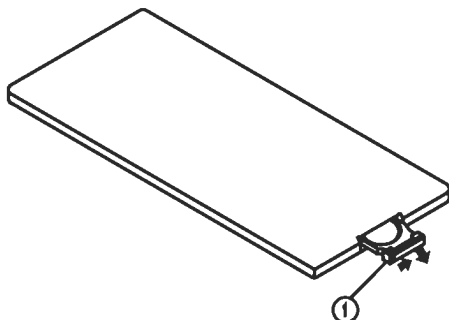

2. Put the button-type battery with mark(+) upward into the Battery Holder.

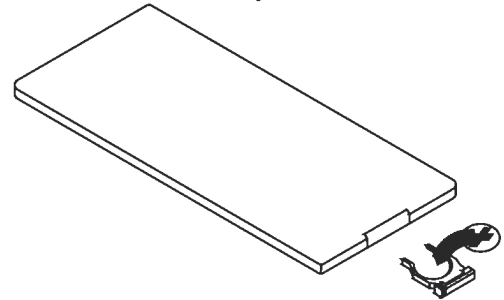

3. Insert the Battery Holder into the Remote Control.

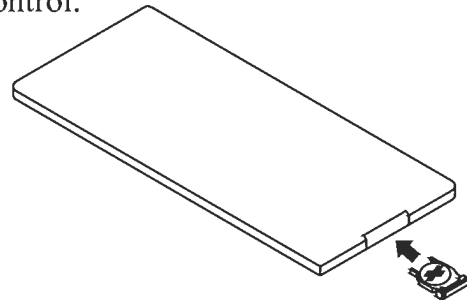

Precautions on Using Lithium Battery

- Always keep the lithium battery beyond children's reach. In case swallowed, see a doctor immediately.
- Cleaning the battery with a dry cloth, to ensure its perfect connected.
- Make sure the proper polarity when loading with the battery.
- To prevent short circuit, do not use metal tweezers to clip the battery.

Warning!

Improperly handling the battery may result in hazardous explosion. It cannot be charged, disassembled or thrown into a fire.

Cleaning the Connector

If the connector between the main unit and the front panel is dirty, it may result the unit in abnormal working condition. To avoid such problems happening, please detach the front panel, and clean the connector with an alcohol swab. Gently clean and avoid damaging the connector.

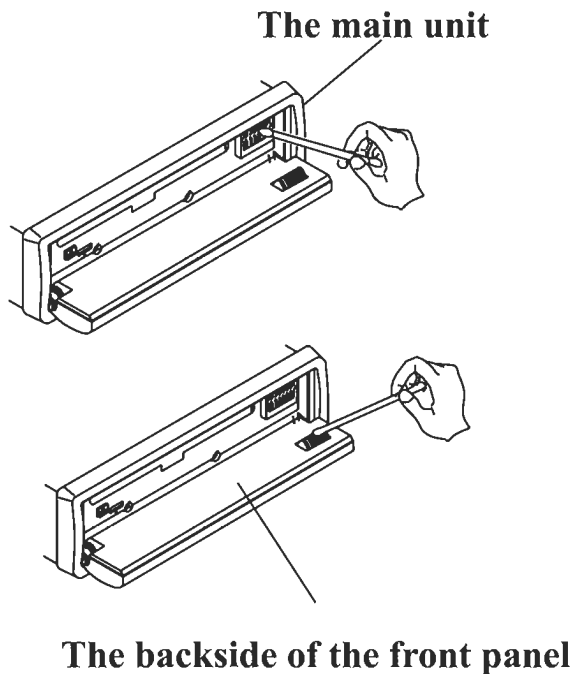

■ Notes

- For safekeeping, always shut down the generator and take out the key from the ignition before cleaning.
- Never keep your finger or any metal device touch the connector directly.

Install the Front Panel

Put notch (A) (Shown as picture) onto shaft (B). And then slightly press into the right side.

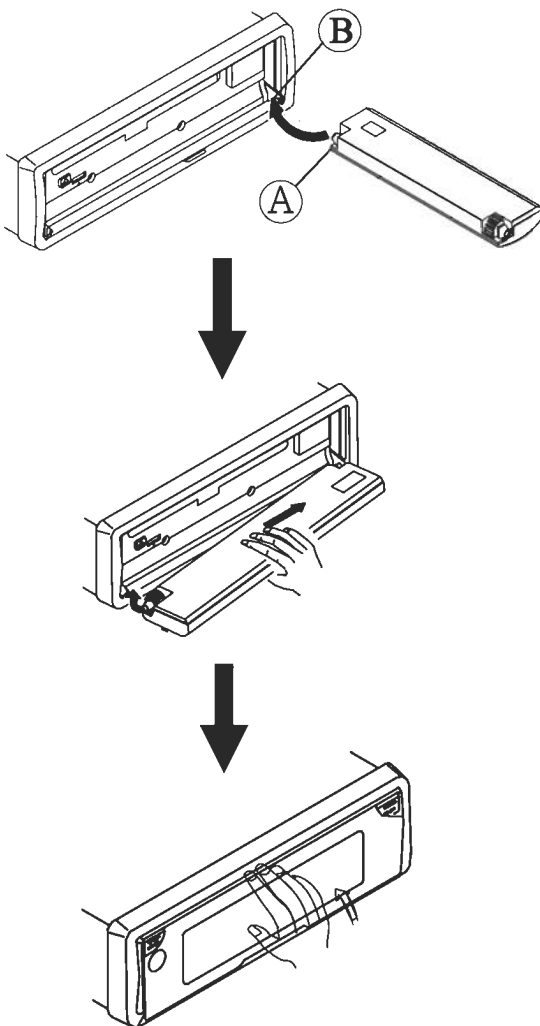

Detach the Front Panel

1. Press (REL) button in the upper right corner, and then the front panel will be folded down.

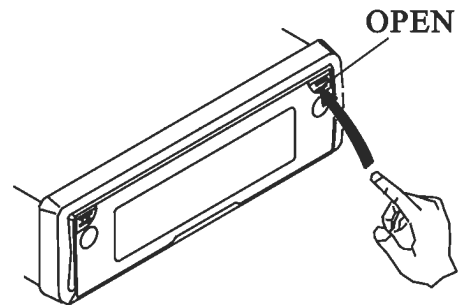

2. When the front panel was turned down to a position of 45°, hold and slide the front panel to left, and then pull it out .

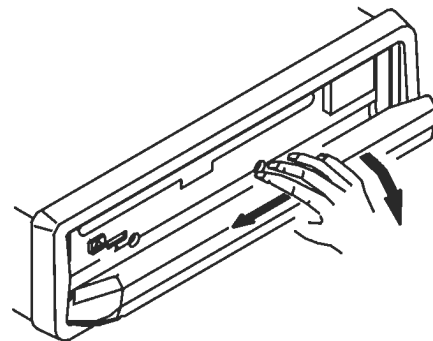

■ **Note:**

Never put any objects into the front panel.

Install the Unit

Installation Method ① : DIN Front-Mount

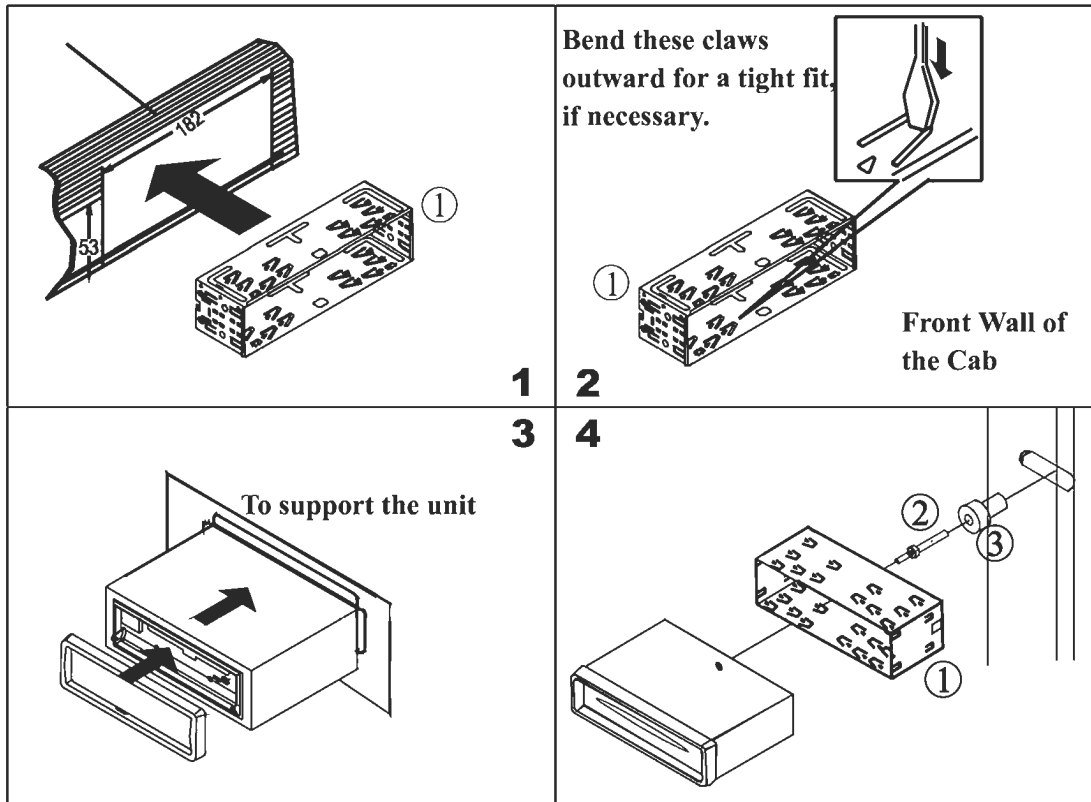

Installation Method ②

Installation using the screw holes at the sides of the unit.

1. Remove the hooks on both sides.
2. Select a position where the screw holes of the mounting bracket supplied with the car and the screw holes of the main unit become aligned (are fitted), and tighten the screws (see ④ at 2 places on each side. And then fasten them to the car.

■ **NOTE:**

Outer Trim Frame ⑤ Hook ⑨ and Mounting Sleeve ① are not used for installation method ②

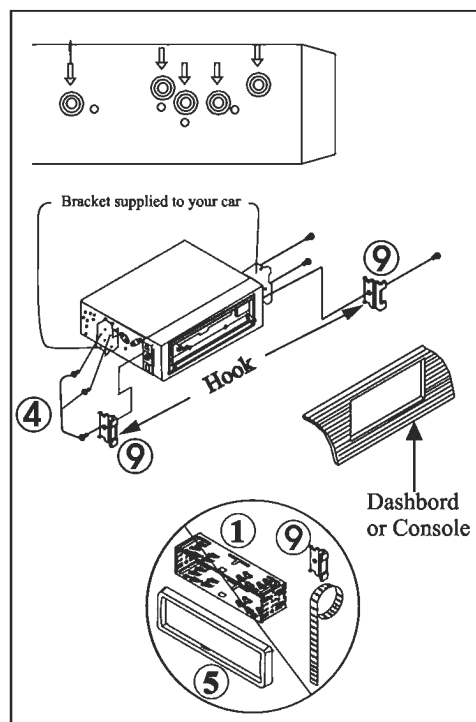

Detach the Unit

Detach the front panel before disassembling the unit. For more details regarding this section, refer to “*Detach the Front Panel*” on Page 43 .

1. Take out the Outer Trim Frame after detaching the front panel.

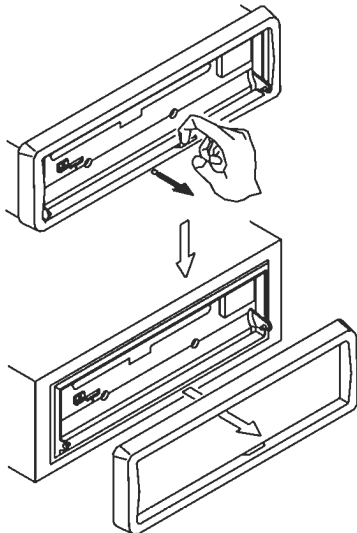

2. Insert the keys supplied to the unit at both sides of the unit (shown as illustrated) until they click. Pulling the keys makes it possible to remove the unit from the dashboard.

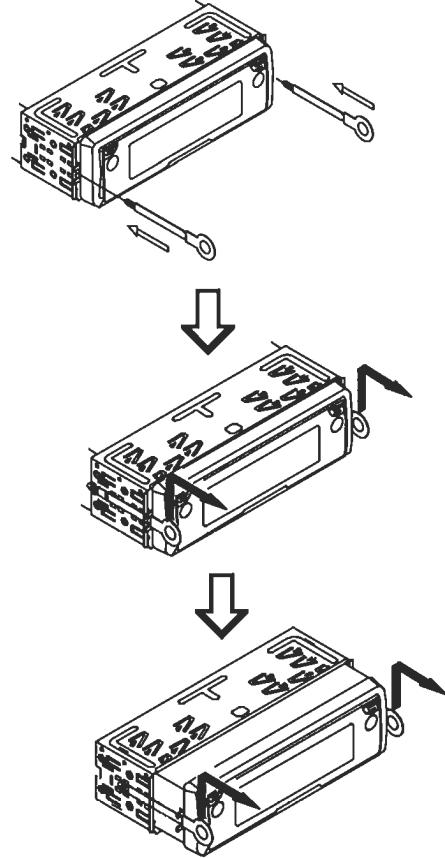

Parts List

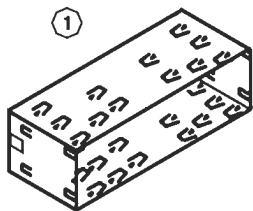

Mounting Sleeve x1

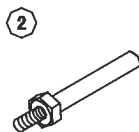

Rear Mounting Bolt x1



Harness Rubber x1

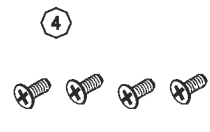

M5 x 5
4 Screws

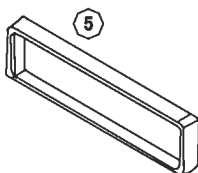

Outer Trim Frame

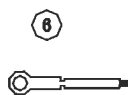

Keys

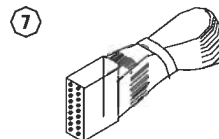

Connecting Wire x1

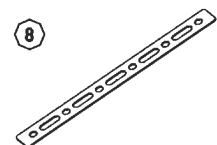

Metallic Lath x1

OPERATIONAL MANUAL

Specifications

General

Power Requirement	14.4V DC (11-16V allowable)
Load Impedance	4Ω
Max.Power Output	25W X 4
Tone Controls	±10dB Bass 100Hz Treble 10KHz
Dimensions	Approx.192 x 178 x50 mm (d/w/h)
Mounting Dimensions	Approx.169 x 182x53 mm (d/w/h)
Weight	Approx.1.75kg

FM Section

Tuning Range	87.5-108(MHz) (China/Europe) 87.5-107.9(MHz) (U.S.A.) 65-74(MHz) (Russia)
IF Range	10.7MHz
Usable Sensitivity (-30dB)	10dBuV
Singal-to-noise Ratio	60dB
Stereo Separation	30dB (1KHz)
Frequency Response	30-15000Hz

AM Tuner Section

Frequency Range	522-1620(KHz) (Europe/China/Russia) 530-1710 (KHz) (U.S.A.)
IF Range	450KHz
Usable Sensitivity (-20dB)	28dBuV

CD Player Section

VCD Signal System	PAL/NTSC
Singal-to-noise Ratio	65dB
Separation	60dB(1KHz)
Distortion	0.1%

DVD Player Section

Number of channel	2 channels
Frequency Response	5Hz to 20,000Hz
Dynamic Range	98dB
Signal-to-Noise Ratio	73dB
Wow and Flutter	Less than measurable limit

Note:

Due to continuous product improvement, specifications and design are subject to change without prior notice.

Simple Troubleshooting Guide

The following checklist is helped to solve the problems which you meet when using the unit. Please double check and make sure if the connection and the procedure of the operation is properly before using the checklist below .

Problem	Cause/Solution
No power.	<ul style="list-style-type: none">• Check and make sure whether the fuse is blown, replace with the proper value if necessary.
Some errors occur in the LCD or no function when pressing the button.	<ul style="list-style-type: none">• Press RESET button.
Unable to receive stations.	<ul style="list-style-type: none">• Check and make sure whether the antenna is inserted or the antenna is properly connected, if so, insert the antenna or connect it properly.
Poor effect on receiving a station.	<ul style="list-style-type: none">• Antenna may not be the proper length. Make sure the antenna is fully extended or broken; if broken, replace the antenna with a new one.• The antenna is poorly grounded, check and make sure the antenna is properly grounded at its mounting location. .
CDs cannot be loaded.	<ul style="list-style-type: none">• A CD is loaded in the mechanism.
Sound skips.	<ul style="list-style-type: none">• The CD is dirty or damaged.
No images.	<ul style="list-style-type: none">• The Video line from main unit to the TV is not connected properly.
Images skip.	<ul style="list-style-type: none">• Improper setting of the color system. Set the color system to “PAL” or “NTSC” according to the connected television.

Note:

If any of the problem persist after check list had been made, consult your nearest service dealer. Never attempt to disassemble your unit by yourself.