

TEC

TEC Label Printer

B-450-HS-QQ SERIES

Owner's Manual

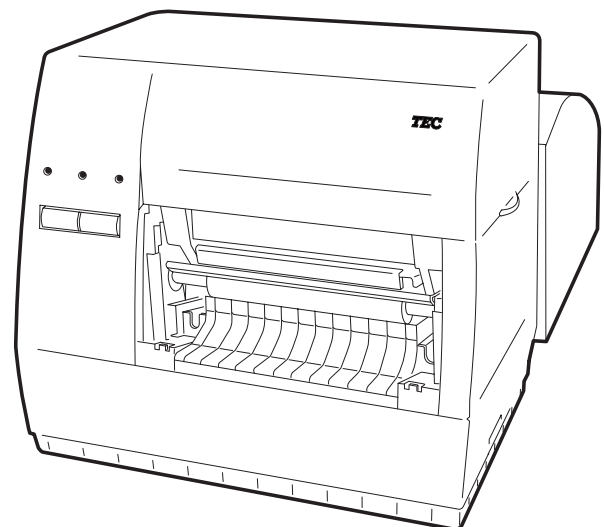

TOSHIBA TEC CORPORATION

This equipment has been tested and found to comply with the limits for a Class A digital device, pursuant to Part 15 of the FCC Rules. These limits are designed to provide reasonable protection against harmful interference when the equipment is operated in a commercial environment. This equipment generates, uses, and can radiate radio frequency energy and, if not installed and used in accordance with the instruction manual, may cause harmful interference to radio communications. Operations of this equipment in a residential area is likely to cause harmful interference in which case the user will be required to correct the interference at his own expense. (for USA only)

Changes or modifications not expressly approved by manufacturer for compliance could void the user's authority to operate the equipment.

"This Class A digital apparatus meets all requirements of the Canadian Interference-Causing Equipment Regulations."

"Cet appareil numérique de la classe A respecte toutes les exigences du Règlement sur le matériel brouilleur de Canada."

(for CANADA only)

敬告使用者：

這是甲類的資訊產品,在居住的環境中使用時,可能會造成射頻干擾,在這種情況下,使用者會被要求採取某些適當的對策。

(for QQ only)

Safety Summary

Personal safety in handling or maintaining the equipment is extremely important. Warnings and Cautions necessary for safe handling are included in this manual. All warnings and cautions contained in this manual should be read and understood before handling or maintaining the equipment. Do not attempt to effect repairs or modifications to this equipment. If a fault occurs that cannot be rectified using the procedures described in this manual, turn off the power, unplug the machine, then contact your authorized TOSHIBA TEC representative for assistance.

Meanings of Each Symbol



This symbol indicates warning items (including cautions). Specific warning contents are drawn inside the \triangle symbol. (The symbol on the left indicates a general caution.)



This symbol indicates prohibited actions (prohibited items). Specific prohibited contents are drawn inside or near the \circ symbol. (The symbol on the left indicates "no disassembling".)



This symbol indicates actions which must be performed. Specific instructions are drawn inside or near the \bullet symbol. (The symbol on the left indicates "disconnect the power cord plug from the outlet".)



WARNING

This indicates that there is the risk of **death** or **serious injury** if the machines are improperly handled contrary to this indication.



Any other than the specified AC voltage is prohibited.

■ Do not use voltages other than the voltage (AC) specified on the rating plate, as this may cause **fire** or **electric shock**.

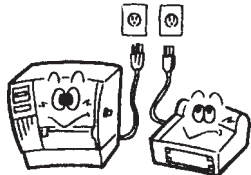

Prohibited

■ Do not plug in or unplug the power cord plug with wet hands as this may cause **electric shock**.

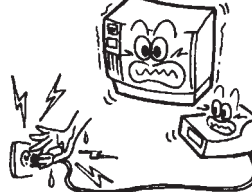

Prohibited

■ If the machines share the same outlet with any other electrical appliances which consume large amounts of power, the voltage will fluctuate widely each time these appliances operate. Be sure to provide an exclusive outlet for the machine as this may cause the machines to **malfunction**.



Prohibited

■ Do not place metal objects or water-filled containers such as flower vases, flower pots or mugs, etc. on top of the machines. If metal objects or spilled liquid enter the machines, this may cause **fire** or **electric shock**.



Prohibited

■ Do not insert or drop metal, flammable or other foreign objects into the machines through the ventilation slits, as this may cause **fire** or **electric shock**.

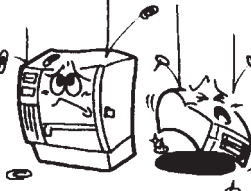

Prohibited

■ Do not scratch, damage or modify the power cords. Also, do not place heavy objects on, pull on, or excessively bend the cords, as this may cause **fire** or **electrical shock**.

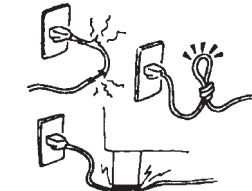

Disconnect the plug.







■ If the machines are dropped or their cabinets damaged, first turn off the power switches and disconnect the power cord plugs from the outlet, and then contact your authorized TOSHIBA TEC representative for assistance. Continued use of the machine in that condition may cause **fire** or **electric shock**.

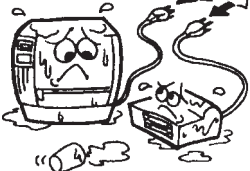

Disconnect the plug.

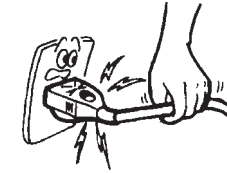
■ Continued use of the machines in an abnormal condition such as when the machines are producing smoke or strange smells may cause **fire** or **electric shock**. In these cases, immediately turn off the power switches and disconnect the power cord plugs from the outlet. Then, contact your authorized TOSHIBA TEC representative for assistance.

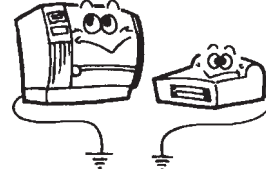

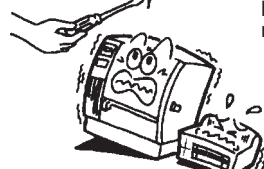
 <p>Disconnect the plug.</p>  <p>■ If foreign objects (metal fragments, water, liquids) enter the machines, first turn off the power switches and disconnect the power cord plugs from the outlet, and then contact your authorized TOSHIBA TEC representative for assistance. Continued use of the machine in that condition may cause fire or electric shock.</p>	 <p>Disconnect the plug.</p>  <p>■ When unplugging the power cords, be sure to hold and pull on the plug portion. Pulling on the cord portion may cut or expose the internal wires and cause fire or electric shock.</p>
 <p>Connect a grounding wire.</p>  <p>■ Ensure that the equipment is properly grounded. Extension cables should also be grounded. Fire or electric shock could occur on improperly grounded equipment.</p>	 <p>No disassembling.</p>  <p>■ Do not remove covers, repair or modify the machine by yourself. You may be injured by high voltage, very hot parts or sharp edges inside the machine.</p>



CAUTION This indicates that there is the risk of personal **Injury** or **damage** to objects if the machines are improperly handled contrary to this indication.

Precautions

The following precautions will help to ensure that this machine will continue to function correctly.

- Try to avoid locations that have the following adverse conditions:
 - * Temperatures out of the specification
 - * Direct sunlight
 - * High humidity
 - * Shared power source
 - * Excessive vibration
 - * Dust/Gas
- The cover should be cleaned by wiping with a dry cloth or a cloth slightly dampened with a mild detergent solution. NEVER USE THINNER OR ANY OTHER VOLATILE SOLVENT on the plastic covers.
- USE ONLY TOSHIBA TEC SPECIFIED paper and ribbons.
- DO NOT STORE the paper or ribbons where they might be exposed to direct sunlight, high temperatures, high humidity, dust, or gas.
- Ensure the printer is operated on a level surface.
- Any data stored in the memory of the printer could be lost during a printer fault.
- Try to avoid using this equipment on the same power supply as high voltage equipment or equipment likely to cause mains interference.
- Unplug the machine whenever you are working inside it or cleaning it.
- Keep your work environment static free.
- Do not place heavy objects on top of the machines, as these items may become unbalanced and fall causing **injury**.
- Do not block the ventilation slits of the machines, as this will cause heat to build up inside the machines and may cause **fire**.
- Do not lean against the machine. It may fall on you and could cause **injury**.
- Care must be taken not to injure yourself with the printer paper cutter.
- Unplug the machine when it is not used for a long period of time.

Request Regarding Maintenance

- Utilize our maintenance services.
After purchasing the machine, contact your authorized TOSHIBA TEC representative for assistance once a year to have the inside of the machine cleaned. Otherwise, dust will build up inside the machines and may cause a **fire** or a **malfunction**. Cleaning is particularly effective before humid rainy seasons.
- Our preventive maintenance service performs the periodic checks and other work required to maintain the quality and performance of the machines, preventing accidents beforehand. For details, please consult your authorized TOSHIBA TEC representative for assistance.
- Using insecticides and other chemicals
Do not expose the machines to insecticides or other volatile solvents. This will cause the cabinet or other parts to deteriorate or cause the paint to peel.

TABLE OF CONTENTS

	Page
1. INTRODUCTION	1- 1
1.1 APPLICABLE MODEL	1- 1
1.2 ACCESSORIES	1- 1
2. SPECIFICATIONS	2- 1
2.1 GENERAL SPECIFICATIONS	2- 1
2.2 PRINTING SPECIFICATIONS	2- 1
2.3 PAPER (LABEL) SPECIFICATIONS	2- 2
2.4 RIBBON SPECIFICATIONS	2- 2
2.5 OPTION	2- 2
3. APPEARANCE	3- 1
3.1 FRONT/REAR VIEW	3- 1
3.2 OPERATION PANEL	3- 1
4. DIP SWITCH FUNCTIONS	4- 1
5. SETUP PROCEDURE	5- 1
5.1 REQUIREMENTS FOR OPERATION	5- 1
5.2 SETTING UP THE PRINTER	5- 1
6. INSTALLATION PROCEDURE	6- 1
6.1 INSTALLING THE SUPPLY HOLDER UNIT	6- 1
6.2 INSTALLING THE SUPPLY COVER	6- 1
6.3 CONNECTING THE POWER CORD AND CABLES	6- 2
7. LOADING THE RIBBON	7- 1
8. LOADING THE PAPER	8- 1
9. THRESHOLD SETTING	9- 1
10. CARE/HANDLING OF THE PAPER AND RIBBON	10- 1
11. GENERAL MAINTENANCE	11- 1
11.1 CLEANING	11- 1
11.2 COVERS	11- 2
11.3 REMOVING JAMMED PAPER	11- 3
12. TROUBLESHOOTING	12- 1
APPENDIX	13- 1
INDEX	

CAUTION:

1. This manual may not be copied in whole or in part without prior written permission of TOSHIBA TEC.
2. The contents of this manual may be changed without notification.
3. Please refer to your local Authorized Service representative with regard to any queries you may have in this manual.

1. INTRODUCTION

Thank you for choosing the TEC B-450 Series thermal transfer printer. This new generation high performance high quality printer is equipped with the latest hardware including the newly developed high density (23.6 dots/mm 600 dots/inch) print head. This allows very clear print at a maximum speed of 50.8 mm/sec. (2 inch/sec.). Other standard features include an external paper supply.

Optional features include a strip mechanism and cutter mechanism.

This manual contains general set-up and maintenance information and should be read carefully to help gain maximum performance and life from your printer. For most queries please refer to this manual and keep it safe for future reference.

1.1 APPLICABLE MODEL

- B-452-HS12-QQ
- B-452-HS12-QQ-US

Model name description

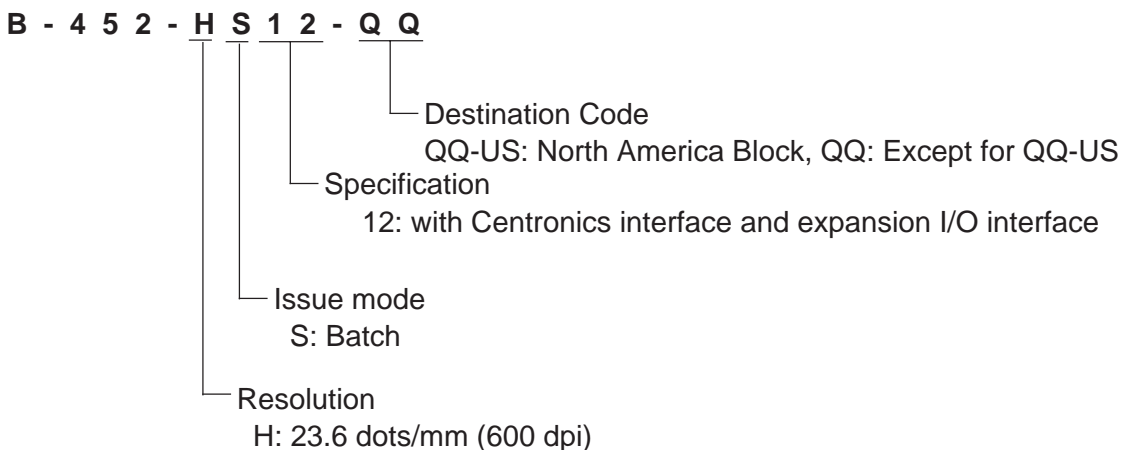

1.2 ACCESSORIES

Owner's Manual
(EO1-33019)



Power Cord

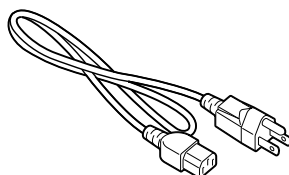

Supply Holder Unit



Supply Cover

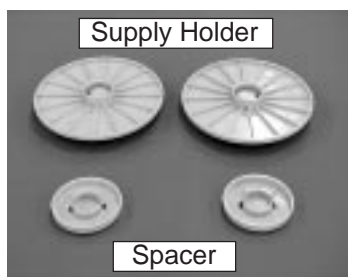
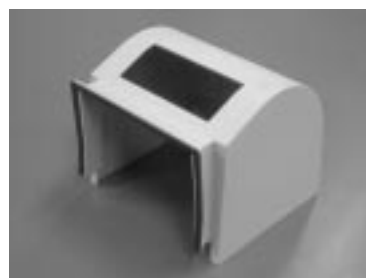

2. SPECIFICATIONS

2.1 GENERAL SPECIFICATIONS

Item \ Model	B-452-HS12-QQ
Supply voltage	100 - 120V, 60Hz
Power consumption	1.8 A, 140 W max. (standby: 0.22 A, 13.5 W)
Operating temperature	5°C ~ 40°C
Relative humidity	25% ~ 85%RH (no condensation)
Dimensions	268 mm (width) x 244 mm (height) x 198 mm (depth), with Supply holder unit 410 mm (depth)
Weight	Printer: 5.0 kg (without paper and ribbon) Supply Holder + Supply Cover: 2.5 kg

2.2 PRINTING SPECIFICATIONS

Item \ Model	B-452-HS12-QQ
Print head	Thermal print head 23.6 dots per mm (600 dots per inch)
Printing method	Thermal transfer
Print speeds	50.8 mm/sec. (2 inch/sec.)
Maximum print width	103.6 mm (4.08 inches)
Dispensing modes	Batch (Continuous), Strip (Option) and Cut modes (Option) (Both cut and strip modes are available only when their respective modules are fitted.)
Available bar-code types	JAN8, JAN13, EAN8, EAN8 + 2 digits, EAN8 + 5 digits EAN13, EAN13 + 2 digits, EAN13 + 5 digits UPC-E, UPC-E + 2 digits, UPC-E + 5 digits UPC-A, UPC-A + 2 digits, UPC-A + 5 digits, UPC-B MSI, ITF, NW-7, CODE39, CODE93, CODE128, EAN128 Industrial 2 to 5, UCC/EAN128, Customer bar code, POSTNET RM4SCC, KIX code
Two-dimensional code	Data Matrix, PDF417, QR code, Maxi code
Graphics	All types of graphic files are available when using the windows driver. However, only BMP and PCX files are available when using the programming commands.
Fonts	Times Roman (6 sizes), Helvetica (6 sizes), Presentation (1 size), Letter Gothic (1 size), Prestige Elite (2 sizes), Courier (2 sizes), OCR (2 types), Writable characters, Outline font (7 type), True Type fonts Optional True Type Fonts (20 type)
Rotations	0°, 90°, 180°, 270°
Standard interfaces	Serial interface (RS-232C) Parallel interface (Centronics) Expansion I/O interface Keyboard interface

* Data Matrix™ is a trademark of International Data Matrix, Inc.
PDF417 is a trademark of Symbol Technologies, Inc.
QR code is a trademark of DENSO CORPORATION.
Maxi code is a trademark of United Parcel Service of America, Inc.

2.3 PAPER (LABEL) SPECIFICATIONS

[Unit: mm]

Item	Label dispensing mode		
	Batch mode	Strip mode	Cut mode
Span of one label	7.0 ~ 999.0	25.4 ~ 999.0	37.0 ~ 999.0
Label length	5.0 ~ 997.0	23.4 ~ 997.0	31.0 ~ 993.0
Width including backing paper	25.4 ~ 110.0		
Label width	20.0 ~ 107.0		
Gap length	2.0 ~ 20.0	2.0 ~ 20.0	6.0 ~ 20.0
Black mark length	2.0 ~ 10.0		
Effective print width	10.0 ~ 103.6		
Effective print length	3.0 ~ 200.0	21.4 ~ 200.0	29.0 ~ 200.0
Print speed up/slow down area	1.0		
Outer roll diameter	MAX. ϕ 152.4 (Paper Core ϕ 38, 40, 42 or 76.2)		
Thickness (Backing paper + label)	0.1 ~ 0.17	0.13 ~ 0.17	0.1 ~ 0.17
Thickness of backing paper	0.056 ~		

2.4 RIBBON SPECIFICATIONS

Type	Spool type
Width	60 mm ~ 110 mm
Length	(270 m)
Outer diameter	ϕ 65 mm (max.)

- NOTES:**
1. To ensure good print quality and maximum print head life use only TOSHIBA TEC specified paper and ribbons.
 2. For further information about paper and ribbon, refer to Section 10. CARE/HANDLING OF THE PAPER AND RIBBON.

2.5 OPTION

Option Name	Type	Description
Cutter module	B-7204-QM	A stop-and-cut rotary cutter
Strip module	B-7904-H-QM	This module strips the label from the backing paper with the take-up block and strip block.
Keyboard module	KB-80-QM	This module is an external intelligent keyboard unit.

NOTE: To purchase the OPTIONAL KIT, please contact your authorized TOSHIBA TEC representative or TOSHIBA TEC Head Quarter.

3. APPEARANCE

3.1 FRONT/REAR VIEW

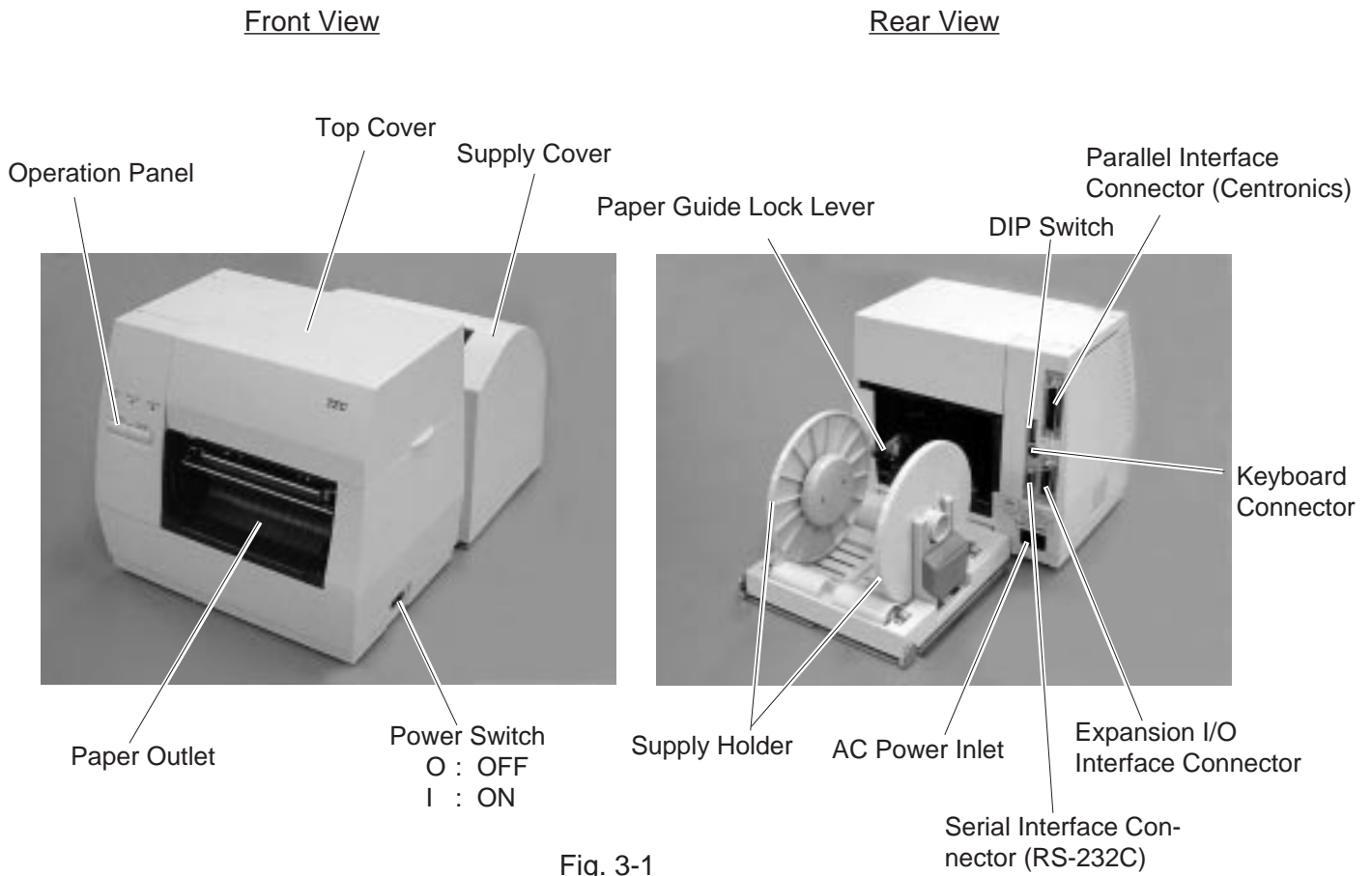

Fig. 3-1

3.2 OPERATION PANEL



Fig. 3-2

POWER LED (Green)

Lights when the power is turned on.

ON-LINE LED (Green)

- 1) Flashes when communicating with a host computer.
- 2) On while printing.

ERROR LED (Red)

Lights when a communication error occurs, when the paper/ribbon ends or the printer is not operating correctly.

FEED Key

Feeds paper.

PAUSE Key

Pauses printing.
Resets the printer when paused or when an error occurs.

4. DIP SWITCH FUNCTIONS

The DIP switches are located at the rear of the printer.

WARNING!

Turn the **POWER OFF** before changing the DIP switches.

DIP SW

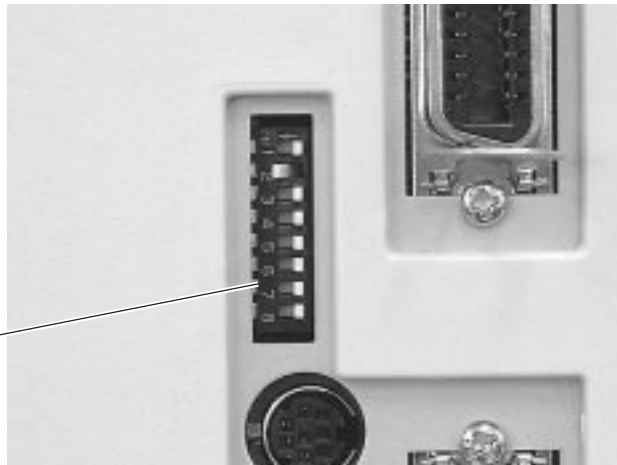

Fig. 4-1

DIP SW

No.	ON/OFF		Function	Remarks
	1	2		
1	OFF	OFF	2400 bps	Transmission speed (Baud rate)
	ON	OFF	4800 bps	
2	OFF	ON	9600 bps	
	ON	ON	19200 bps	
3	OFF		None	Parity
	ON		EVEN	
4	OFF		Not available	Stacker
	ON		Available	
5	OFF		Available	Auto media feed
	ON		Not available	
6	6	7		Selectable only when DIP SW #8 is ON.
	OFF	OFF	RAM clear mode (Maintenance counter)	
7	ON	OFF	Threshold manual setting mode	
	OFF	ON	Sensor adjustment mode	
8	ON	ON	RAM clear mode (Parameter)	
	OFF		Normal operation mode	Operating mode
ON		Program down load operation		

- NOTES:**
1. DIP Switch settings are read at power on time.
 2. To enter the program download mode first set DIP SW #8 to ON. The printer will then enter the relevant modes, as selected by DIP SWS #6 and #7. To initialize these modes hold down the **[FEED]** or **[FEED]** and **[PAUSE]** keys whilst turning the power on. If the printer is turned on without pressing a key, it will enter the program download mode. Do not set the switches to the maintenance mode as this may cause a failure.

5. SET UP PROCEDURE

5.1 REQUIREMENTS FOR OPERATION

This machine has the following requirements:

- The host computer must have a serial port or centronics parallel port.
- To communicate with host, either an RS-232C cable or Centronics cable is required.
 - (1) RS-232C cable 9 pins
 - (2) Centronics cable 36 pins
- To print a label format, create the complete program using the interface/communication manual or use a bespoke labelling package or Windows Driver.

■ Interface Cables

To prevent radiation and reception of electrical noise, the interface cables must meet the following requirements:

- Fully shielded and fitted with metal or metalised connector housings.
- Kept as short as possible.
- Should not be bundled tightly with power cords.
- Should not be tied to power line conduits.

■ RS-232C Cable description

The serial data cable used to connect the printer to the host computer should be one of the following two types:

NOTE: Use an RS-232C cable with imperial (inch) connector securing screws.

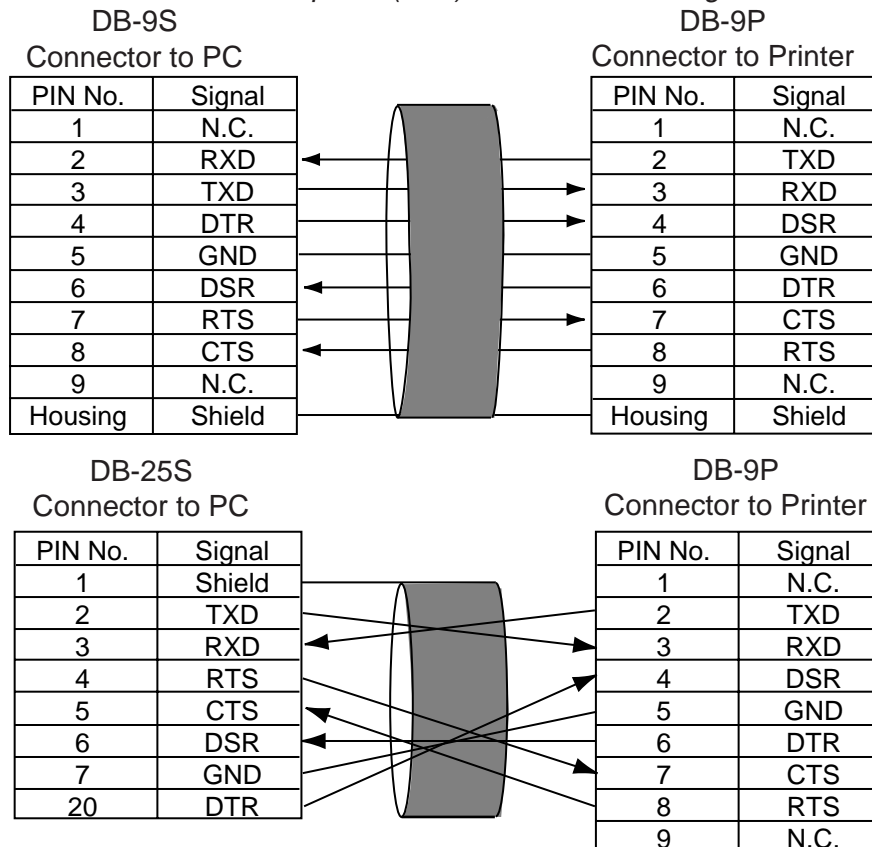

Fig. 5-1

5.2 SETTING UP THE PRINTER

- Place the printer on a flat, stable surface.
- Use a grounded electrical outlet do not use adapter plug.
- Be sure there is adequate room around the printer for easy operation and maintenance.
- Keep your work environment static free.

6. INSTALLATION PROCEDURE

6.1 INSTALLING THE SUPPLY HOLDER UNIT

WARNING!
Turn the power OFF before installing the supply holder unit.

Fit the two studs on the bottom of the printer into the holes in the supply holder unit.

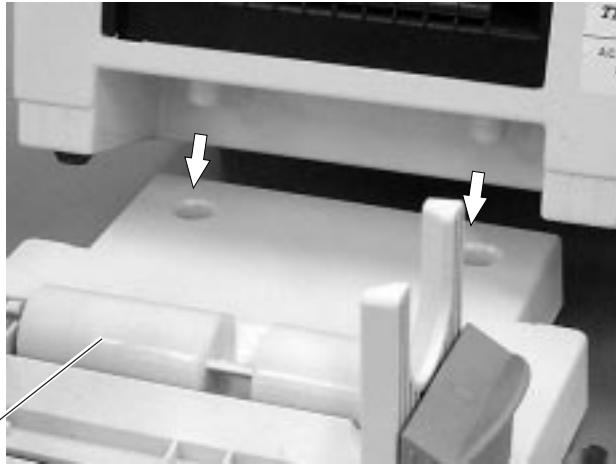

Supply Holder Unit

Fig. 6-1

6.2 INSTALLING THE SUPPLY COVER

Fit both hooks of the supply cover onto the shafts of the supply holder, and then gently close the supply cover. (Refer to Fig. 6-2)

NOTE: After this section, the supply cover will be removed in photos and figures. Please understand that it provides clearer descriptions.

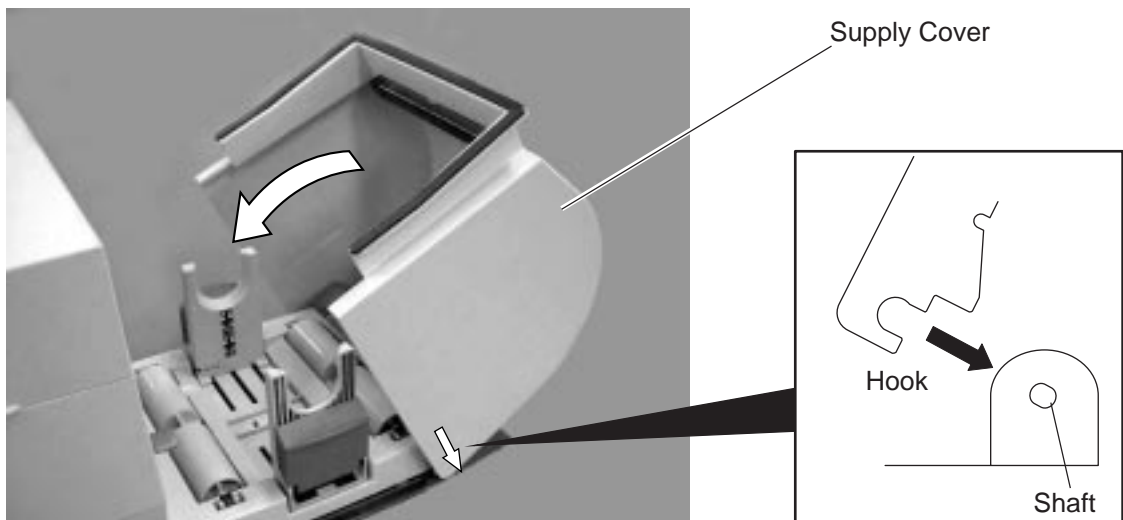

Fig. 6-2

6.3 CONNECTING THE POWER CORD AND CABLES

WARNING!
*Turn the **POWER SWITCH** to **OFF** before connecting the power cord or cables.*

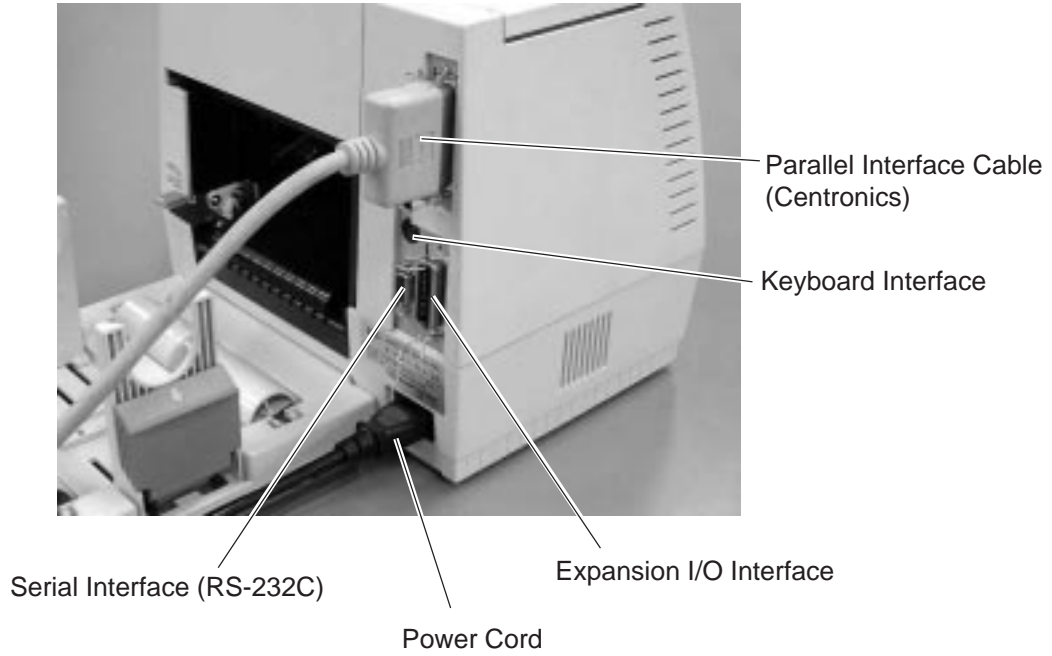

Fig. 6-3

7. LOADING THE RIBBON

WARNING!

Be careful when handling the print head as it becomes very hot.

The printer is capable of printing in thermal transfer mode only.

1. Turn the power off and open the top cover.
2. Move the head release lever toward the front of the printer and raise the print head block.

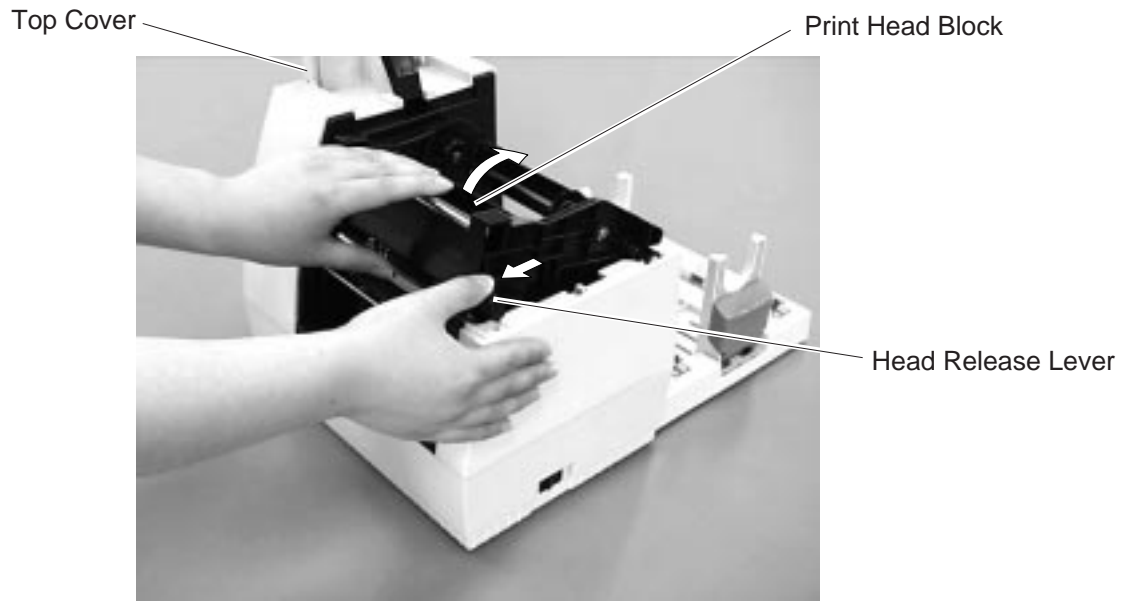

Fig. 7-1

3. Fit the protrusion of the guide wheel into the notch of the ribbon core (take-up side).
4. Pull the knob and set the ribbon core to the spring guide wheel.

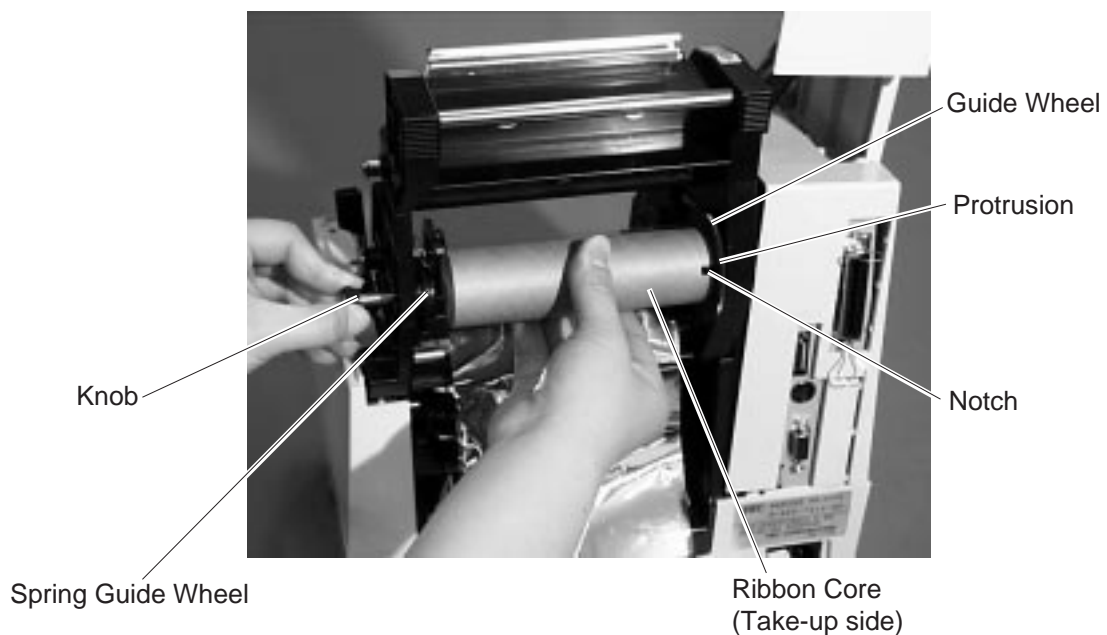

Fig. 7-2

5. Set the ribbon core (supply side) by fitting the protrusion into the notch.



Fig. 7-3

6. Turn the guide wheel in the direction indicated by the arrow to remove any slack on the ribbon.

NOTE: Make sure that the ribbon has no wrinkles and the protrusions are fitted into the notches of the ribbon cores.

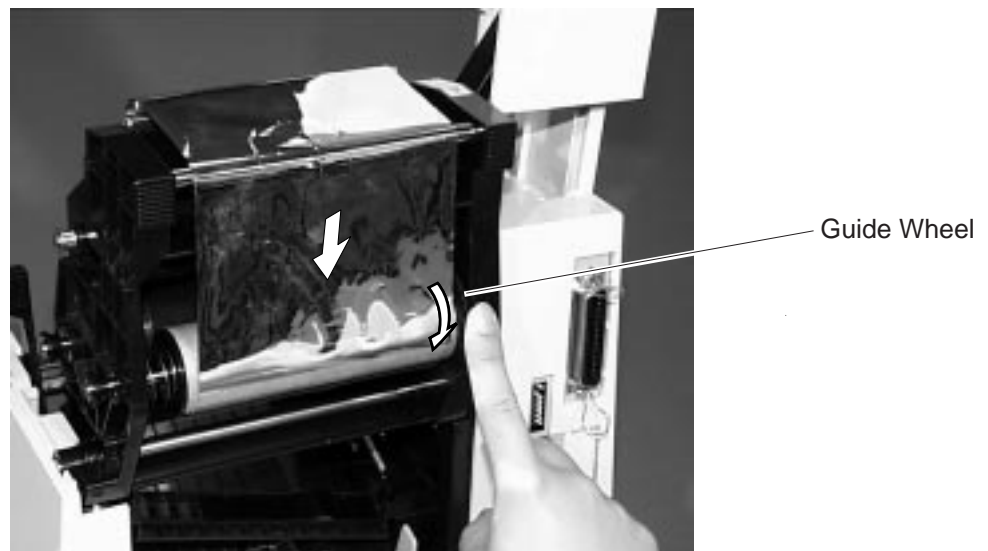

Fig. 7-4

8. LOADING THE PAPER

WARNING!

Be careful when handling the print head as it becomes very hot.

This supply holder accepts four sizes of label core: 38 mm, 40 mm, 42 mm and 76.2 mm. When using a paper roll of 38 mm, 40 mm or 42 mm, remove the spacers from the supply holders using the following procedure.

1. Remove the supply cover.
2. Push both hooks of the spacer to remove it from the supply holder. Keep the removed spacers safe.

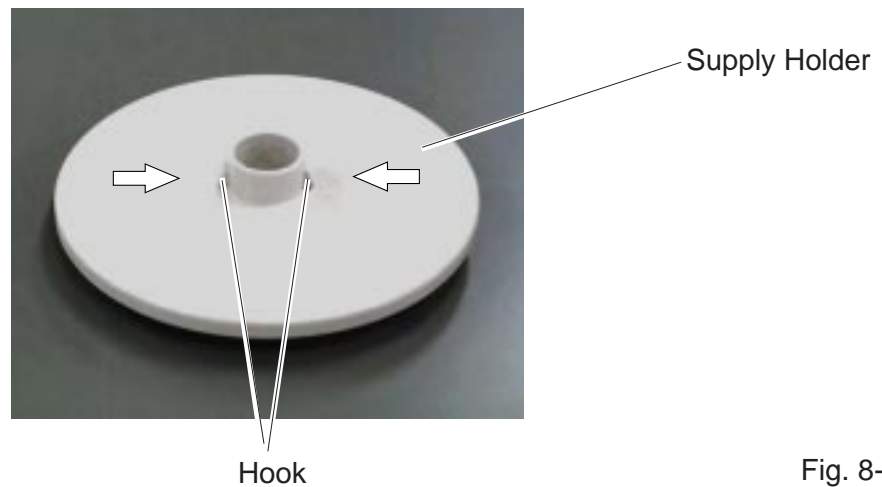

Fig. 8-1

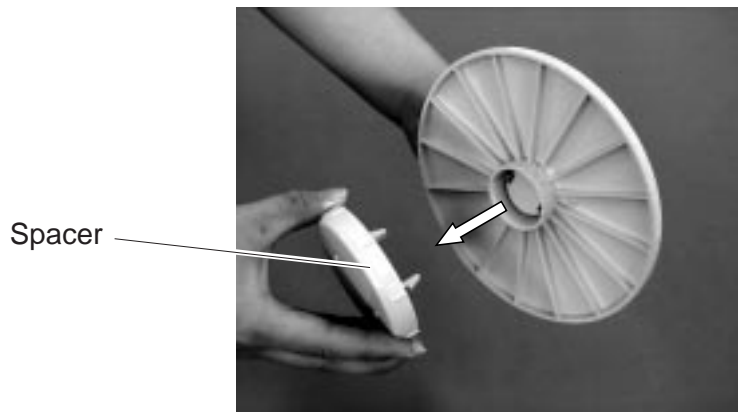

Fig. 8-2

3. Set the supply holders to both sides of the paper roll.

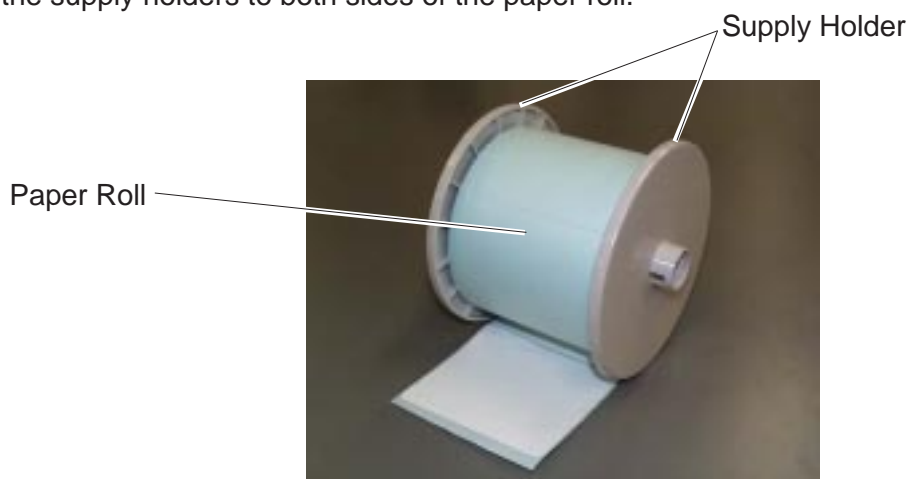

Fig. 8-3

4. Put the paper roll and supply holders on the supply holder unit.

NOTE: The paper must be loaded so that the print side faces upward.
Paper wound inside.

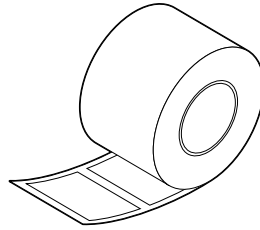

Fig. 8-4

5. Push both sides of the supply holder guides against the paper roll, then lock them with the lock lever.

NOTE: Make sure that the supply holders rotate slightly.

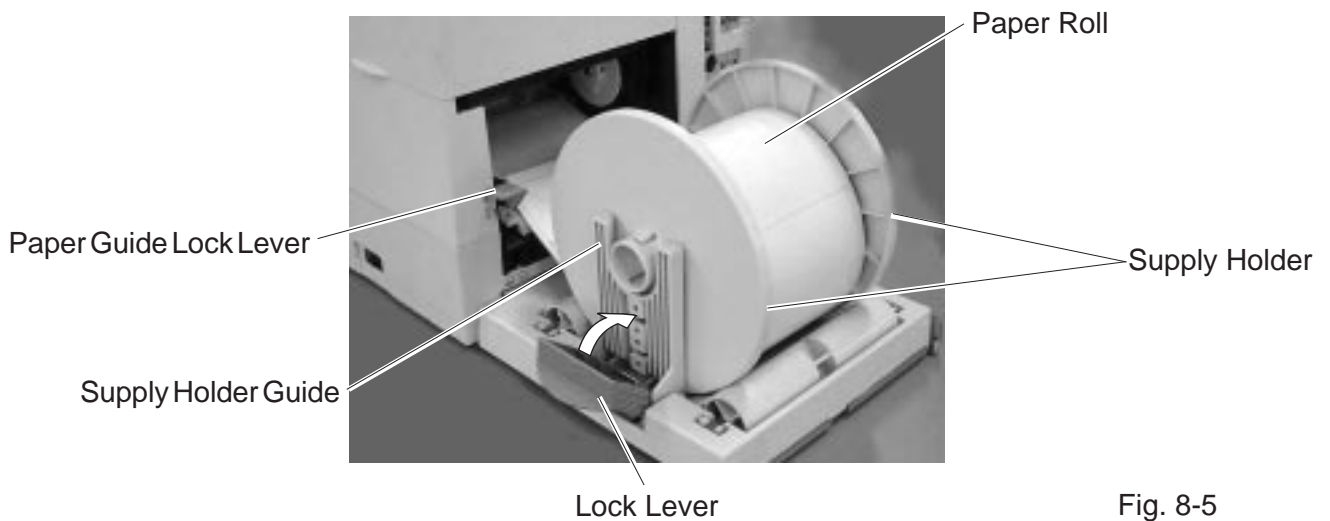

Fig. 8-5

6. Lift up the paper guide lock lever to release the paper guides.

7. Draw the label towards the paper guides.

8. Release the lock lever in the direction indicated by the arrow, and gently lift the sensor cover.

NOTE: Lift the sensor cover gently so that it does not touch the ribbon.

9. Adjust the position of the paper guides to the label width, and return the paper guide lock lever to lock the paper guide.

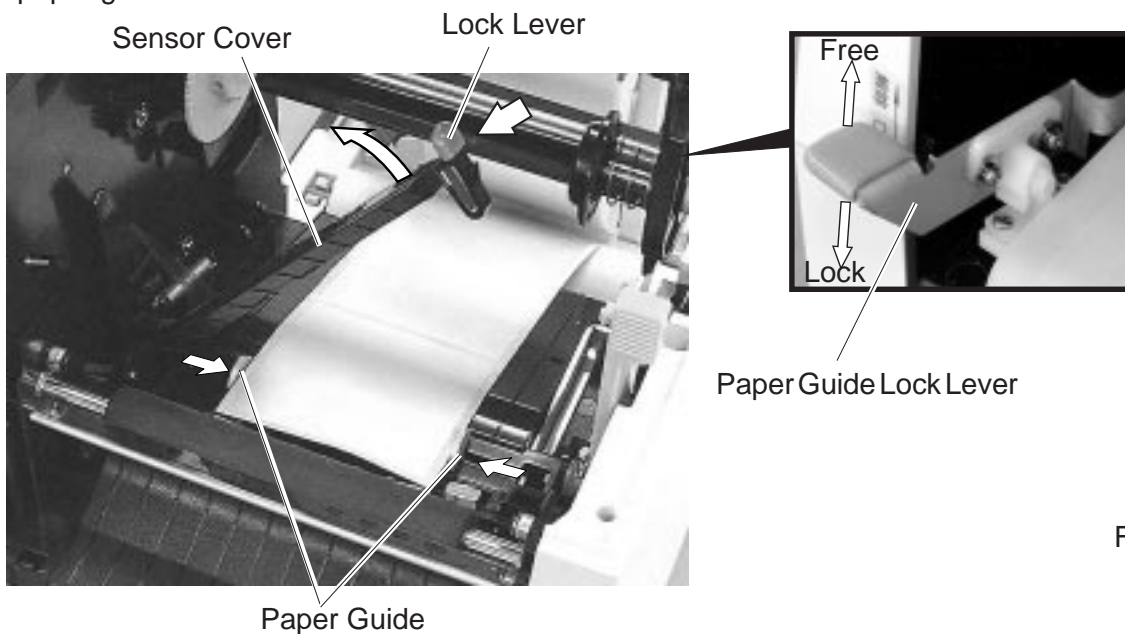

Fig. 8-6

10. For details on changing the black mark sensor position according to the black mark position, refer to the Section "Setting the black mark sensor position". When using the round or pre-printed label, refer to the Section "Setting the feed gap sensor position" and adjust the sensor position.
11. Draw the label onto the platen. Close the sensor cover and return the lock lever to lock the sensor cover tight.
12. Close the print head block by pressing both sides of the print head block's top until it clicks.

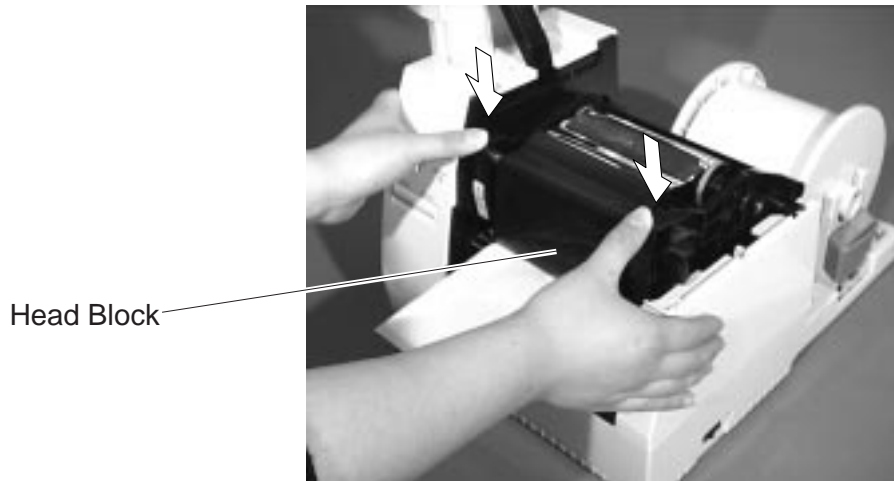

Fig. 8-7

NOTE: Pass the paper straight from the supply holder to paper outlet. Failure to do this may cause skew feeding or paper jam.

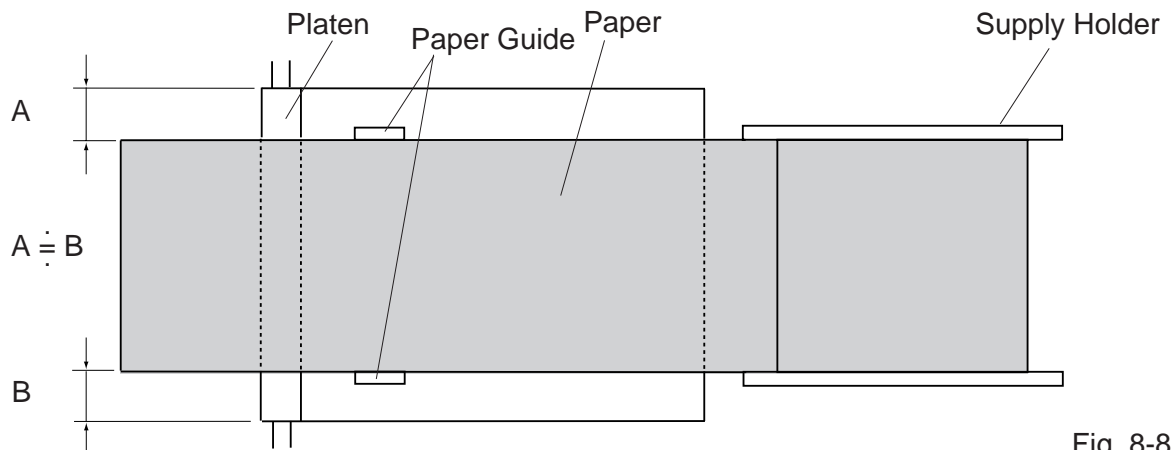

Fig. 8-8

13. Close the top cover, and then attach the supply cover to the supply holder unit. (Refer to section 6.2 INSTALLING THE SUPPLY COVER.) Paper loading is now complete.

Batch type:

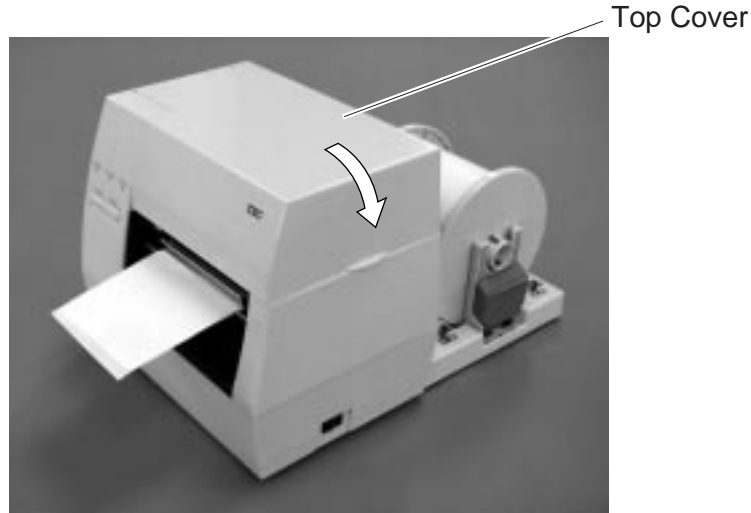

Fig. 8-9

Cutter type: Where a cutter is fitted load the paper as standard and feed it through the cutter module.

NOTE: When using the cutter, be sure to cut the backing paper between the labels. Cutting on the label will cause the glue to stick to the cutter, which may affect the cutter quality and shorten its life.

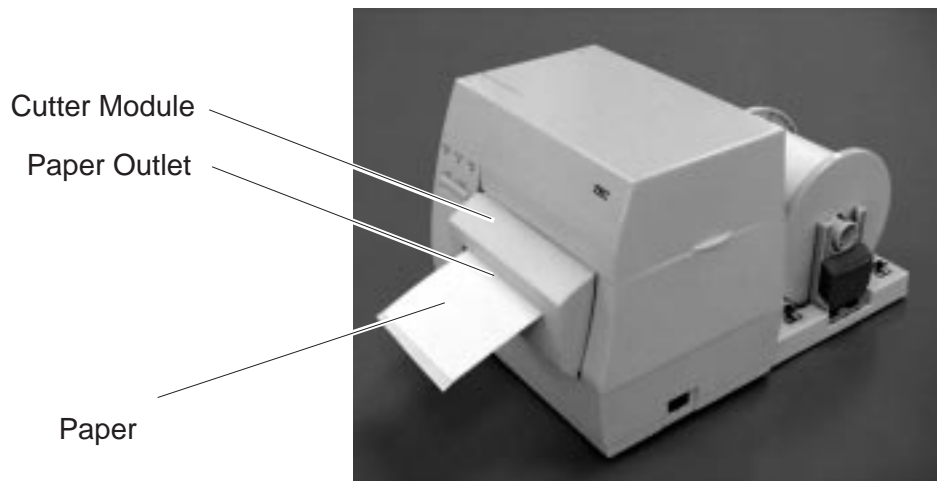

Fig. 8-10

Strip type:

- ① Strip the labels from the backing paper for about 200-mm from the top edge of the label roll.
- ② First push the strip lever toward the printer to release the hook, and then pull the strip lever.
- ③ Pass the backing paper between the strip roller and the strip guide roller. After taking up any slack on the paper, set the strip lever in position.

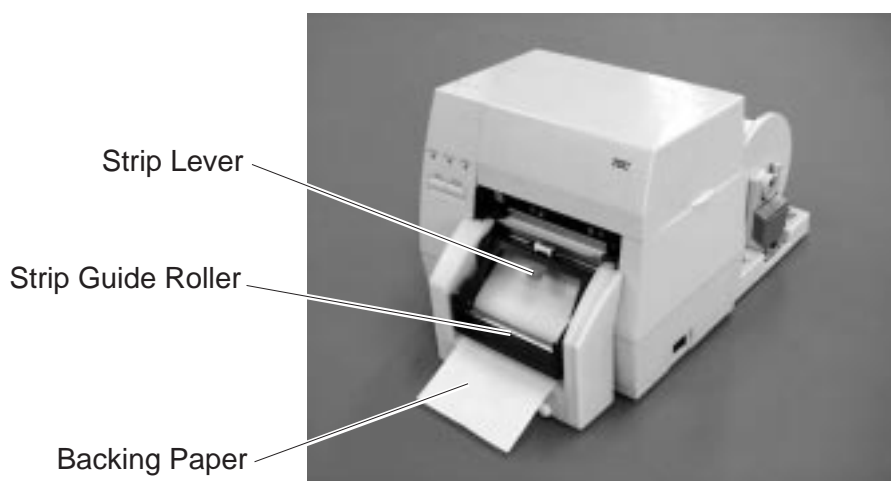



Fig. 8-11

■ Setting the black mark sensor position

- ① Fold over the end of the label. Then, move sensor knob A in a the horizontal direction so that the  mark on the sensor cover aligns with the black mark. Remember the number that centre of the sensor knob A is positioned at. Set the sensor knob B to the same position number.

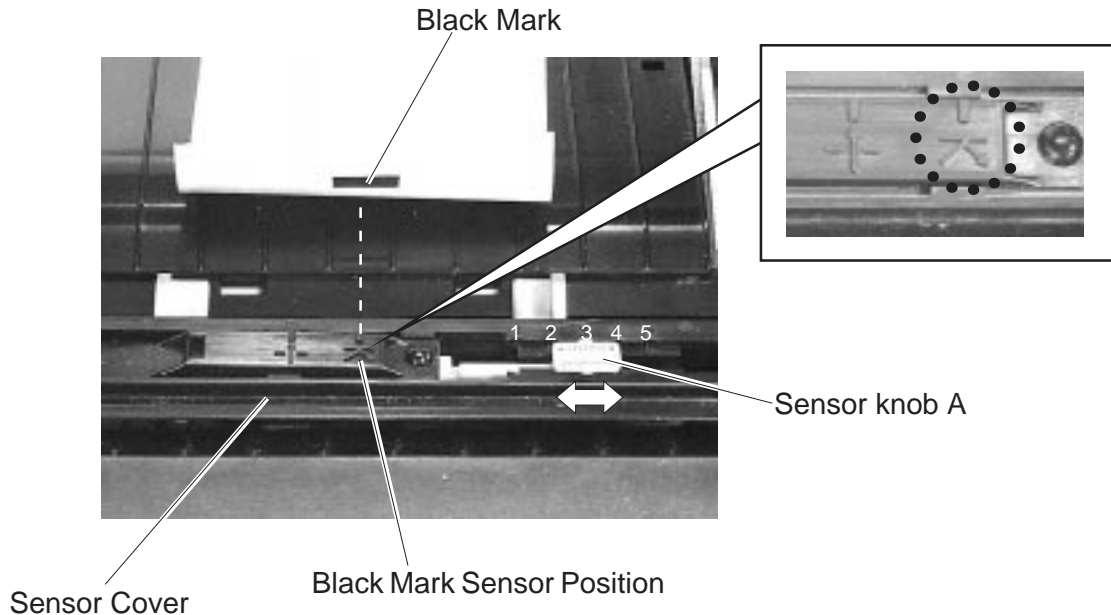

Fig. 8-12

- ② Release the lock lever in the direction indicated by the arrow, and gently lift the sensor cover.
NOTE: Lift the sensor cover gently so that it does not touch the ribbon.

- ③ Set sensor knob B to the same position number as the sensor knob A.
NOTE: The sensor knobs A and B are set to the position #3 where the black mark is centred in the label width as a default. Do not change the position of sensor knobs A and B except when changing the sensor detecting position. Be sure to set sensor knobs A and B to the same position #. Failure to do this may cause a paper feed error and paper end detecting error.

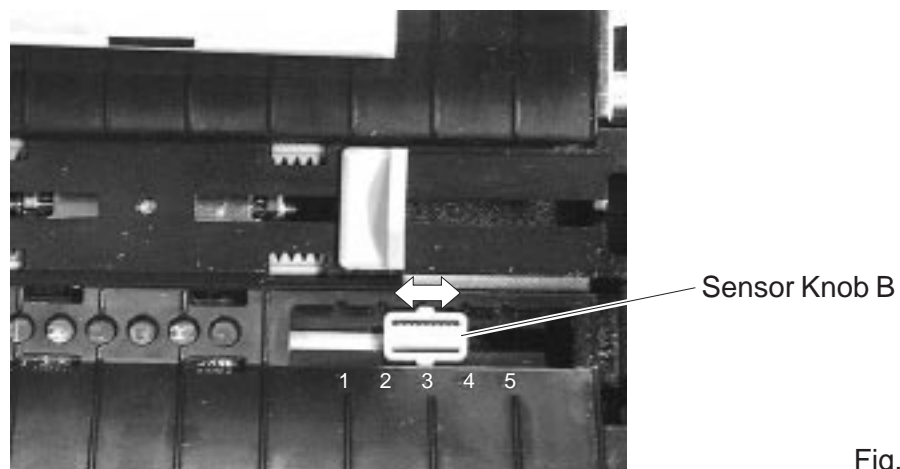



Fig. 8-13

- ④ Draw the label onto the platen. Close the sensor cover and return the lock lever to lock the sensor cover tight.

■ Setting the feed gap sensor position

- ① Move sensor knob A in a horizontal direction so that the  mark on the sensor cover aligns with the centre of the label gap. Remember the number that the centre of the sensor knob A is positioned at. Set sensor knob B to the same position number.

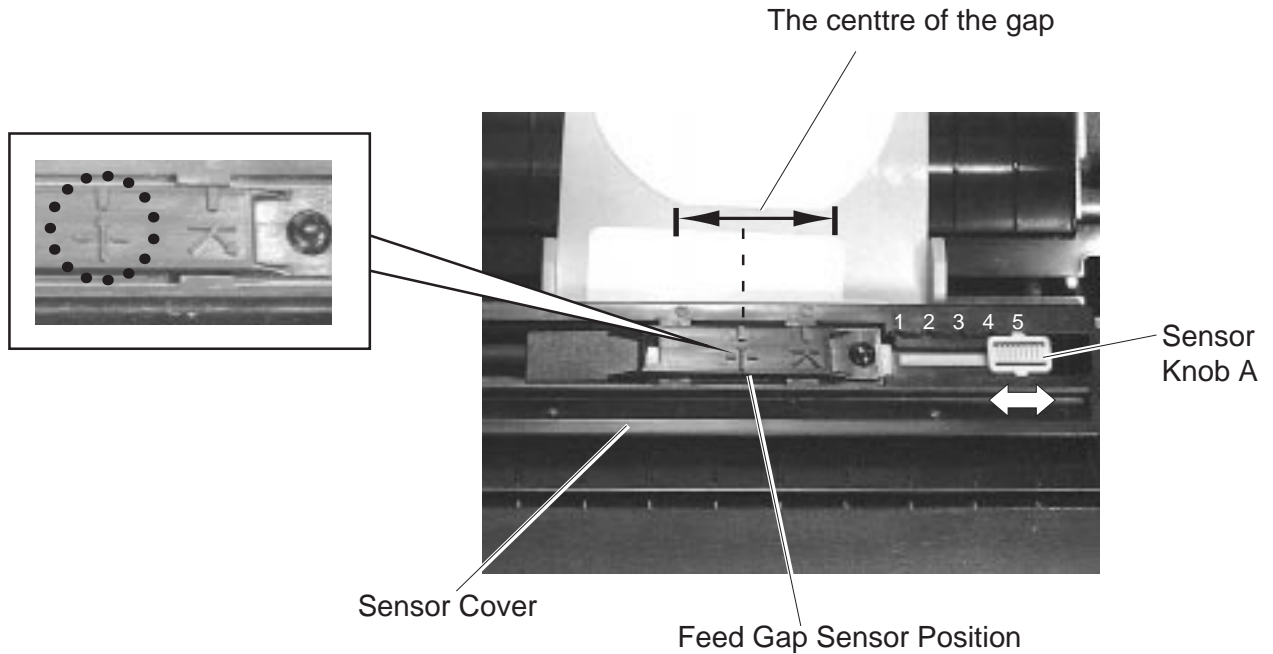

Fig. 8-14

- ② Release the lock lever in the direction indicated by the arrow, and gently lift the sensor cover.

NOTE: Lift the sensor cover gently so that it does not touch the ribbon.

- ③ Set the sensor knob B to the same position # of the sensor knob A.

NOTE: Sensor knobs A and B are set to position #3 where the black mark is centred on the label width as a default. Do not change the position of sensor knobs A and B except when changing the sensor detecting position. Be sure to set the sensor knobs A and B to the same position #. Failure to do this may cause a paper feed error and paper end detecting error.

- ④ Draw the label onto the platen. Close the sensor cover and return the lock lever to lock the sensor cover tight.

9. THRESHOLD SETTING

For the printer to maintain a constant print position it uses the transmissive sensor to measure the amount of light passing through the gap between labels. When the paper is pre-printed, the darker (or more dense) inks can interfere with this process causing paper jam errors. To eliminate this problem a minimum threshold can be set for the sensor in the following way.

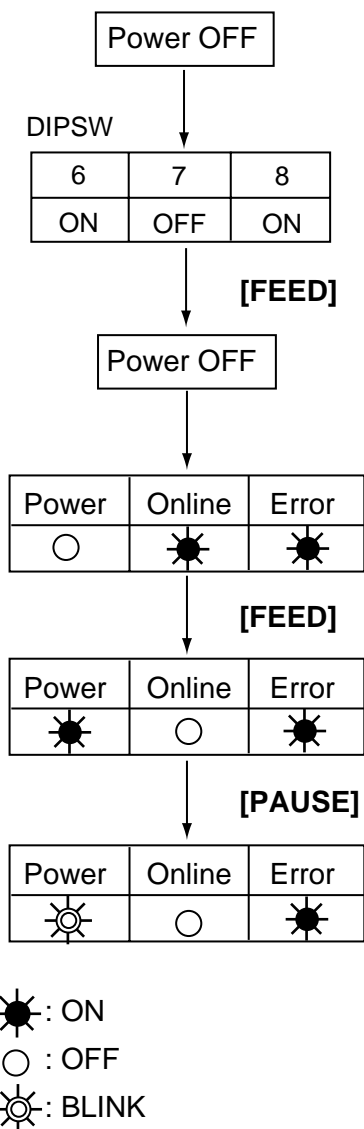

- (1) The power is off.
- (2) Set the DIP switches to enter the manual threshold setting mode.
- (3) Turn the power ON while pressing and holding the **[FEED]** key.

The transmissive sensor is selected.

- (4) Press the **[FEED]** key.
The reflective sensor is selected.
The sensor type is switched by pressing the **[FEED]** key. Load the pre-printed label roll in the usual way.
- (5) Press and hold the **[PAUSE]** key.
The paper will feed through the printer until the **[PAUSE]** key is released. Release the **[PAUSE]** key after more than 1.5 labels have been fed. (Threshold setting is completed by this operation.)
- (6) Turn the power OFF.

NOTES:

1. To set the threshold properly, be sure to feed more than 1.5 labels. Insufficient paper feeding may result in an incorrect threshold setting. In this case, repeat the procedure.
2. While the print head is raised, the **[PAUSE]** key does not work.
3. If the paper runs out or a cutter error occurs, it will not be detected during the paper feed.
4. If the printer does not print in the correct position even after the threshold setting, the transmissive sensor adjustment may be wrong. In this case, re-adjust the transmissive sensor, and then set the threshold again. (When the backing paper is thick, the transmissive sensor adjustment is required.)

10. CARE/HANDLING OF THE PAPER AND RIBBON

CAUTION:

Be sure to read carefully and understand the Supply Manual. Ask your nearest authorized TOSHIBA TEC representative for the Supply Manual. Use only paper and ribbon which meet specified requirements. Use of non-specified paper and ribbon may shorten the head life and result in problems with bar code readability or print quality. All paper and ribbon should be handled with care to avoid any damage to the paper, ribbon or printer. Read the following guideline carefully.

- Do not store the paper and ribbon for longer than the manufactures recommended shelf life.
- Store paper rolls on the flat end, do not store them on the curved sides as this might flatten that side causing erratic media advance and poor print quality.
- Store the paper in plastic bags and always reseal after opening. Unprotected paper can get dirty and the extra abrasion from the dust and dirt particles will shorten the print head life.
- Store the paper and ribbon in a cool, dry place. Avoid areas where they would be exposed to direct sunlight, high temperature, high humidity, dust or gas.
- The thermal paper used for direct thermal printing must not have specifications that exceed Na^+ 800 ppm, K^+ 250 ppm and CL^- 500 ppm.
- Some ink used on pre-printed labels may contain ingredients which shorten the print head's product life. Do not use labels pre-printed with ink which contain hard substances such as carbonic calcium (CaCO_3) and kaolin ($\text{Al}_2\text{O}_3, 2\text{SiO}_2, 2\text{H}_2\text{O}$).

For further information please contact your local distributor or your paper and ribbon manufacturer.

11. GENERAL MAINTENANCE

WARNING!

Be careful when handling the print head as it becomes very hot.

11.1 CLEANING

WARNING!

- 1. Be sure to disconnect the power cord prior to performing any maintenance.*
- 2. DO NOT POUR WATER directly onto the printer.*

CAUTION:

- 1. Do not use any sharp objects to clean the print head and platen. Doing so may damage them, causing poor print quality or missing dots.*
- 2. Never use organic solvents like thinners or benzene for cleaning. Using such solvents may discolour the covers, cause poor print quality, or printer failure.*
- 3. Do not touch the print head element as static build-up may damage the print head.*

To help retain the high quality and performance of your printer it should be regularly cleaned. The greater the usage of the printer, the more frequent the cleaning. (i.e. low usage=weekly : high usage=daily).

1. Turn the power off.
2. Open the top cover.
3. Turn the head lever to raise the print head.
4. Remove the ribbon and paper.
5. Clean the print head element with print head cleaner

NOTE: *Please purchase the print head cleaner from the authorized TOSHIBA TEC service representative.*

Print Head Cleaner
(24089500013)



Print Head (Thermal Element)

Fig. 11-1

6. Clean the platen with a cloth moistened with alcohol.
7. With a soft cloth, remove any dust or glue from the detection area of the sensors and paper path.

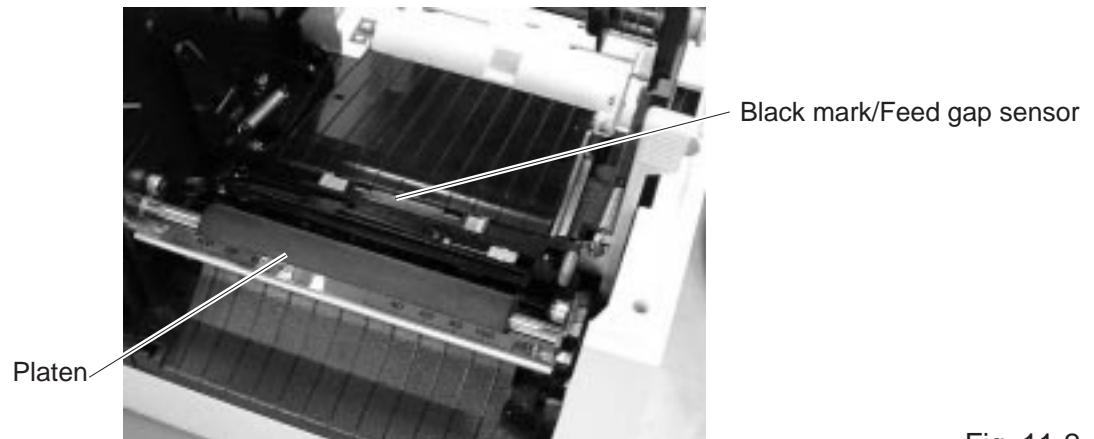

Fig. 11-2

8. Remove the supply holder rollers from the supply holder unit. Remove any dust from the recessed portions of the base and wipe glue from the rollers with a slightly moistened soft cloth.

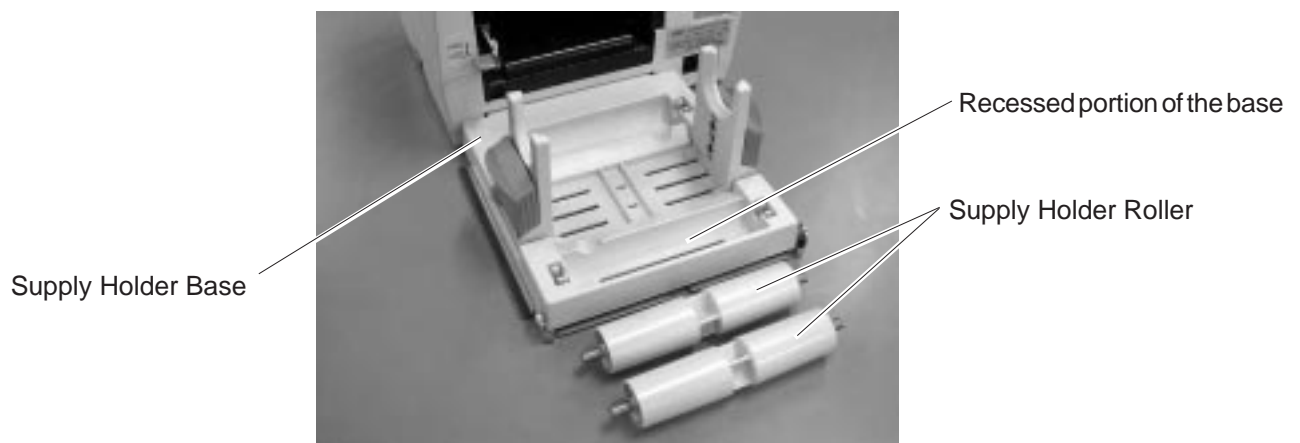

Fig. 11-3

11.2 COVERS

The covers should be cleaned by wiping with a dry cloth or a cloth slightly dampened with a mild detergent solution.

NOTE: Clean printer cover with an electrostatic free cleaner for automated office equipment.

WARNING!

1. **DO NOT POUR WATER** directly onto the printer.
2. **DO NOT APPLY** cleaner or detergent directly onto any cover.
3. **NEVER USE THINNER OR OTHER VOLATILE SOLVENT** on the plastic covers.
4. **DO NOT** clean the covers with alcohol as it may cause them to discolour, loose their shape or develop structural weakness.

11.3 REMOVING JAMMED PAPER

1. Turn the power off.
2. Open the top cover.
3. Move the head release lever toward the front of the printer to raise the print head block.
4. Remove the ribbon and paper.
5. Release the lock lever in the direction indicated by the arrow, and gently lift the sensor cover.
6. Remove the jammed paper. DO NOT USE any sharp implement or tool as these could damage the printer.
7. Clean the print head and platen, then remove any further dust or foreign substances.

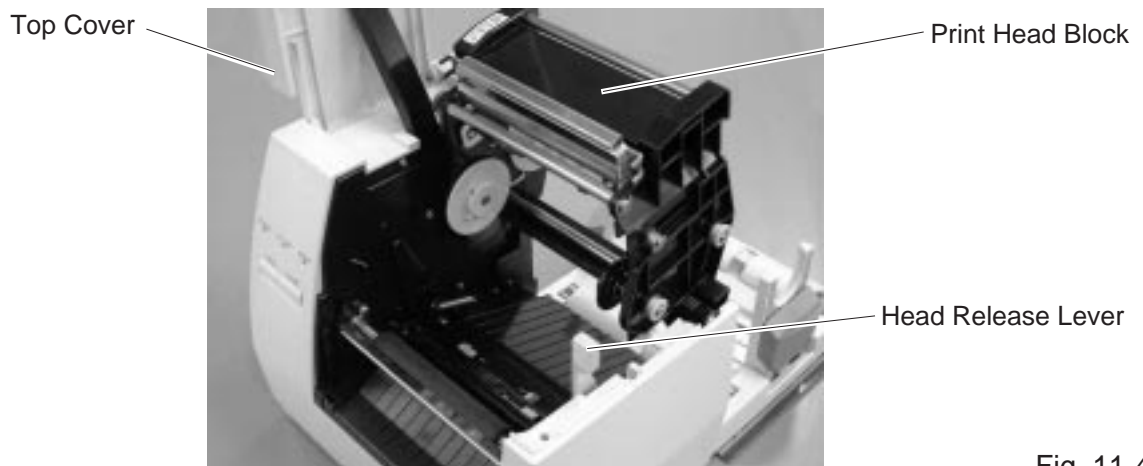

Fig. 11-4

8. Paper jams in the cutter unit can be caused by wear or residual glue from label stock on the cutter. Do not use unspecified paper in the cutter. If frequent jams occur in the cutter contact your Authorized Service representative.

■ Cleaning the Cutter Unit

WARNING!

1. Be sure to disconnect the power cord before cleaning the cutter unit.
2. The cutters are sharp and care should be taken not to injure yourself when cleaning.

1. Press the cutter cover release lever to detach the cutter cover.

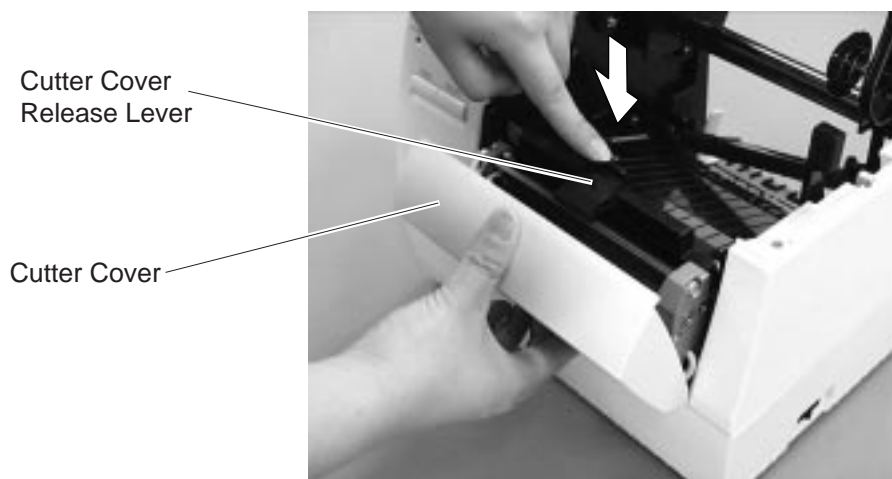

Fig. 11-5

2. Fit the enclosed Allen Key into the right side of the cutter unit to rotate the cutter manually. Remove the jammed paper and any paper particles from the cutter.
3. Clean the cutter with dry cloth.

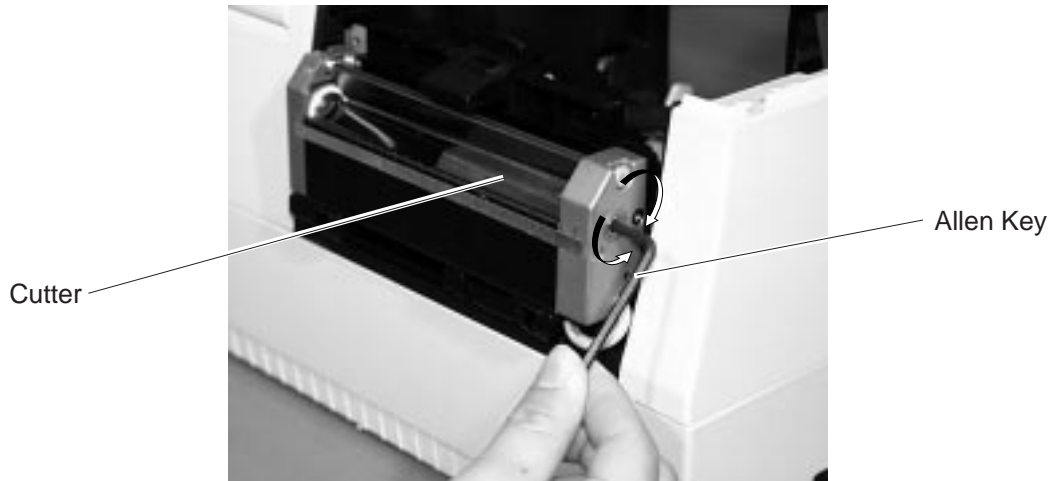

Fig. 11-6

4. Assemble in the reverse order of removal.

■ Cleaning the Strip Unit

WARNING!

1. Be sure to disconnect the power cord before cleaning the strip unit.
2. Do not touch the moving parts. To reduce the risk that fingers, jewellery, clothing, etc., be drawn into the moving parts, push the switch in the "OFF" position to stop movement.

1. First push the strip lever toward the printer to release the hook, and then pull the strip lever.
2. Remove the jammed paper, if any.
3. Clean the strip guide rollers A and B with a cloth moistened with alcohol.

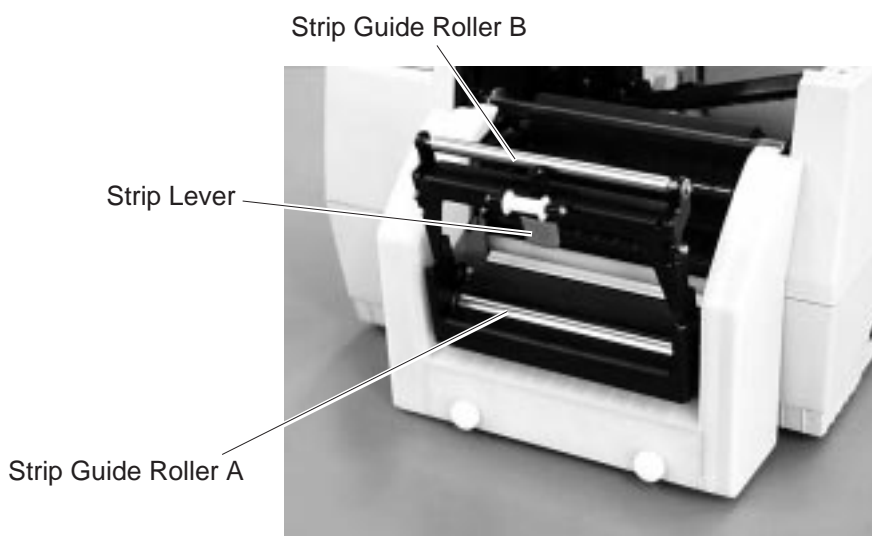

Fig. 11-7

12. TROUBLESHOOTING

WARNING!

If you cannot solve a problem with the following solutions, do not attempt to repair it yourself. Turn the power off, unplug the printer, then contact your TOSHIBA TEC representative for assistance.

If the error lamp lights during printing, refer to the following troubleshooting to solve the problem.

Error type	Problem	Solution
PAPER JAM	<ol style="list-style-type: none"> The paper is not fitted correctly. The paper path is jammed and does not feed smoothly. The installed paper type does not match the selected sensor. The installed paper size is different from the programmed size. The feed gap sensor cannot see the difference between the print area and the gap. 	<ol style="list-style-type: none"> Reload the paper correctly. → Press the [PAUSE] key. Remove the cause of the jam and replace the paper correctly. → Press the [PAUSE] key. Turn the power off then on again. Select the correct sensor. → Feed the paper. Turn the power off then on again. Set the correct paper size. → Feed the paper. Set the threshold (see page 9-1). Else Turn the power off and call your Authorized Service representative.
HEAD OPEN	Feeding or printing has been attempted while the print head is raised.	Lower the print head block. → Press the [PAUSE] key.
NO PAPER	The paper has run out.	Load new paper. → Press the [PAUSE] key.
EXCESS HEAD TEMP.	The print head is too hot.	Turn the power off and decrease the print head temperature.
RIBBON ERROR	<ol style="list-style-type: none"> The ribbon has run out. There is a fault with the ribbon sensor. 	<ol style="list-style-type: none"> Load a new ribbon. → Press the [PAUSE] key. Turn the power off and contact your Authorized Service representative.

Error type	Problem	Solution
HEAD ERROR	This message is displayed when sending the head broken check command ([ESC] HD001 [LF] [NUL]) and the print head has a broken element.	<ol style="list-style-type: none"> Restart the printing by pressing the [PAUSE] key. Replace the print head.
CUTTER ERROR	Paper is jammed in the cutter.	<p>Remove the jammed paper and feed the undamaged media through the cutter (See page 11-3).</p> <p>→ Press the [PAUSE] key.</p> <p>Else</p> <p>Turn the power off and contact your Authorized Service representative.</p>
Other Error	Hardware or software trouble.	Turn the power off then on again. If the problem still exists turn the power off and contact your Authorized Service representative.
<p>NOTE: <i>If an error cannot be cleared by pressing the [PAUSE] key, the power must be switched off then on again.</i></p> <p><i>Once the power has been switched off and on, all the print data in the printer is cleared.</i></p>		

Problem	Solution
No print.	<ol style="list-style-type: none"> Check that the paper and ribbon are loaded correctly. Check that print head is set correctly. Check the cabling between the printer and the host.
Dots missing in the print.	<p>Dirty print head. → Clean the print head.</p> <p>Call your Authorized Service representative if necessary.</p>
Unclear (or blurred) printing.	<ol style="list-style-type: none"> Dirty print head. → Clean the print head. Bad or faulty ribbon. → Replace ribbon. Poor paper quality. → Change paper type.
Power does not come on.	<ol style="list-style-type: none"> Plug the power cord into an AC socket. Check the circuit breakers or fuses. Plug another appliance into the AC socket to check if there is power supplied. <p>Call your Authorized Service representative if necessary.</p>
Printer does not cut.	<p>Check for a paper jam in the cutter.</p> <p>Call your Authorized Service representative if necessary.</p>
You see a raised nap where the paper has been cut.	<ol style="list-style-type: none"> Clean the cutter blades. The blades are worn. <p>→ Call your Authorized Service representative.</p>

APPENDIX

■ ASCII Code Chart

	0	1	2	3	4	5	6	7	8	9	A	B	C	D	E	F
0				0	@	P	`	p	Ç	É	á	€		ð	Ó	–
1			!	1	A	Q	a	q	ü	æ	í	€		Ð	ß	±
2			"	2	B	R	b	r	é	Æ	ó			È	Ò	=
3			#	3	C	S	c	s	â	ô	ú			Ê	Ô	¼
4			\$	4	D	T	d	t	à	ö	ñ			È	ö	¶
5			%	5	E	U	e	u	à	ò	Ñ	Á		×	Õ	§
6			&	6	F	V	f	v	â	û	+	À	ā	í	μ	÷
7			'	7	G	W	g	w	ç	ù	⊕	À	Ā	î	þ	°
8			(8	H	X	h	x	ê	ÿ	¿	⊕		ï	ƒ	•
9)	9	I	Y	i	y	ë	ÿ	⊕			Û	¨	◦
A			*	:	J	Z	j	z	è	Û	¬			Ü	·	◦
B			+	;	K	[k	{	ï	ø	½			Ù	¹	◦
C			,	<	L	\	l		î	£	¼			Ý	³	◦
D			-	=	M]	m	~	ï	Ø	¼			ÿ	²	◦
E			.	>	N	^	n	~	Ä	×	«	¥		ì	—	◦
F			/	?	O	_	o	⌘	Å	f	»			í	—	◦

■ Font Sample

A/0123456789@ABCDEFGHIJKL G/0123456789@ABCDEFGHIJKLMNPOQRS
 B/0123456789@ABCDEFGH H/0123456789@ABCDEFGH
 C/0123456789@ABCDEFG I /0123456789@ABCDE
 D/0123456789@ABCDEF J /0123456789@ABCDE
 E/0123456789@ABCD K/0123456789@ABC
 F/0123456789@ABCDE L /0123456789@ABCDE
M/0123456789@ABCDEFGHIJKL
 N/0123456789@ABCDEFGHIJKLMNO
 O/0123456789@ABCDEFGHIJKLMNO
 P/0123456789@ABCDEFGH
 Q/0123456789@ABCDEFGH
 R/0123456789@ABCDEF
 S/0123456789@ABCDEF
 T/0123456789@ABCDEF

ABC

■ Barcode Sample

0: JAN8, EAN8 4: NW7

 
 ABCDEF1234F a1234567890a
 4940 0458

2: ITF 5: JAN13, EAN13

 
 012345678905 4 901480 079516

3: CODE39 (Standard) 9, A: CODE128

 
 ABC123 ABCDEFGHI

INDEX

- A**
- AC Power inlet 3-1
 - Auto media feed 4-1
- B**
- Bar code types 2-1
- C**
- Cleaning 11-1
- D**
- DIP switch 3-1, 4-1
- F**
- Fonts 2-1
- I**
- Interface 1-1, 2-1
 - Centronics cable 5-1
 - Expansion I/O interface 2-1
 - Keyboard interface 2-1
 - Parallel interface 2-1
 - Parallel interace cable 6-2
 - RS-232C cable 5-1
 - Serial interface 2-1
 - Serial interface cable 6-2
 - Serial interface connector 3-1
 - Issue mode 1-1
- J**
- Jammed paper 11-3
- L**
- Label length 2-2
 - Label width 2-2
- O**
- Operation panel 3-1
 - ERROR LED 3-1
 - FEED key 3-1
 - ON-LINE LED 3-1
 - PAUSE key 3-1
 - POWER LED 3-1
 - Option 2-2
 - Cutter 11-4
 - Cutter module 2-2, 8-4
 - Keyboard module 2-2
 - Strip mechanism 1-1
 - Strip module 2-2
- P**
- Paper 2-2, 10-1
 - Paper jam 12-1
 - Power consumption 2-1
 - Power cord 1-1, 6-2
 - Power switch 3-1
 - Print head 1-1, 2-1, 11-1
 - Print head cleaner 11-1
 - Print length 2-2
 - Print speed 2-1
 - Print width 2-2
 - Printing method 2-1
 - Program down load operation 4-1
- R**
- Relative humidity 2-1
 - Resolution 1-1
 - Ribbon 2-2, 7-1, 10-1
- S**
- Sensor knob A 8-5, 8-6
 - Sensor knob B 8-5, 8-6
 - Sensor
 - Black mark sensor 11-2
 - Feed gap sensor 11-2
 - Sensor adjustment mode 4-1
 - Specifications 2-1
 - Stacker 4-1
 - Supply Cover 1-1, 2-1, 3-1, 6-1
 - Supply holder 1-1, 3-1, 8-1
 - Supply holder unit 1-1, 6-1
 - Supply voltage 2-1
- T**
- Thermal print head 2-1
 - Thermal transfer 1-1, 2-1
 - Threshold manual setting mode 4-1
 - Threshold setting 9-1
 - Transmission speed 4-1
 - Troubleshooting 12-1
 - Two-dimensional code 2-1
- W**
- Weight 2-1



TEC
TOSHIBA TEC CORPORATION

E PRINTED IN JAPAN
EO1-33019