

# OPERATOR'S MANUAL

## DUAL PORT BATTERY CHARGER

### 140276004

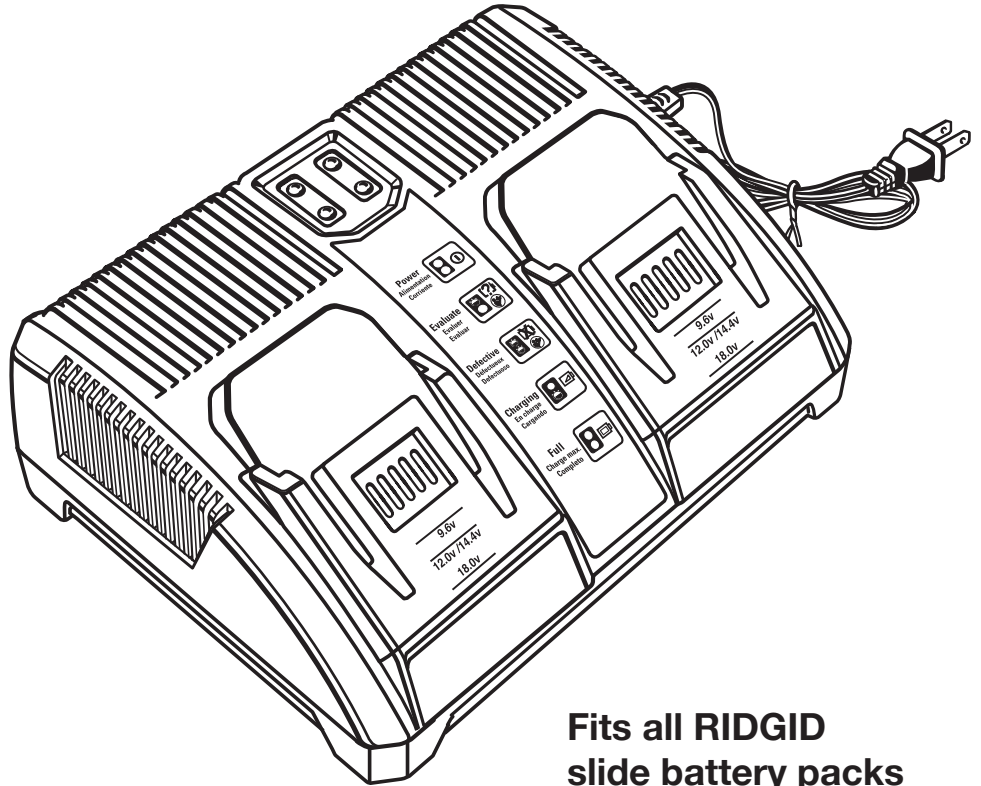

**Fits all RIDGID  
slide battery packs**

Your dual port charger has been engineered and manufactured to our high standards for dependability, ease of operation, and operator safety. When properly cared for, it will give you years of rugged, trouble-free performance.

**⚠ WARNING:**

To reduce the risk of injury, the user must read and understand the operator's manual before using this product.

Thank you for buying a RIDGID product.

**SAVE THIS MANUAL FOR FUTURE REFERENCE**

# IMPORTANT SAFETY INSTRUCTIONS

---

## **WARNING!**

### **READ AND UNDERSTAND ALL INSTRUCTIONS.**

Failure to follow all instructions listed below, may result in electric shock, fire and/or serious personal injury.

- **Before using battery charger**, read all instructions and cautionary markings in this manual, on battery charger, battery, and product using battery to prevent misuse of the products and possible injury or damage.

## **CAUTION:**

To reduce the risk of electric shock or damage to the charger and battery, charge only nickel-cadmium rechargeable batteries as specifically designated in this manual. Other types of batteries may burst, causing personal injury or damage.

- **Do not use charger outdoors or expose to wet or damp conditions.** Water entering charger will increase the risk of electric shock.
- **Use of an attachment not recommended or sold by the battery charger manufacturer may result in a risk of fire, electric shock, or injury to persons.** Following this rule will reduce the risk of electric shock, fire, or serious personal injury.
- **Do not abuse cord or charger.** Never use the cord to carry the charger. Do not pull the charger cord rather than the plug when disconnecting from receptacle. Damage to the cord or charger could occur and create an electric shock hazard. Replace damaged cords immediately.
- **Make sure cord is located so that it will not be stepped on, tripped over, come in contact with sharp edges or moving parts, or otherwise subjected to**

**damage or stress.** This will reduce the risk of accidental falls, which could cause injury, and damage to the cord, which could result in electric shock.

- **Keep cord and charger from heat to prevent damage to housing or internal parts.**
- **Do not let gasoline, oils, petroleum-based products, etc., come in contact with plastic parts.** They contain chemicals that can damage, weaken, or destroy plastic.
- **Do not operate charger with a damaged cord or plug,** which could cause shorting and electric shock. If damaged, have the charger replaced by an authorized serviceman.
- **Do not operate charger if it has received a sharp blow, been dropped, or otherwise damaged in any way.** Take it to an authorized serviceman for electrical check to determine if the charger is in good working order.
- **Do not disassemble charger.** Take it to an authorized serviceman when service or repair is required. Incorrect reassembly may result in a risk of electric shock or fire.
- **Unplug charger from outlet before attempting any maintenance or cleaning to reduce the risk of electric shock.**
- **Disconnect charger from the power supply when not in use.** This will reduce the risk of electric shock or damage to the charger if metal items should fall into the opening. It also will help prevent damage to the charger during a power surge.
- **Risk of electric shock.** Do not touch uninsulated portion of output connector or uninsulated battery terminal.
- **Save these instructions.** Refer to them frequently and use them to instruct others who may use this tool. If you loan someone this tool, loan them these instructions also to prevent misuse of the product and possible injury.

# IMPORTANT SAFETY INSTRUCTIONS

## 1. SAVE THESE INSTRUCTIONS





This manual contains important safety and operating instructions for battery charger 140276004.

2. **Before using battery charger**, read all instructions and cautionary markings on battery charger, battery, and product using battery.

3. **CAUTION:** To reduce the risk of injury, charge only nickel-cadmium rechargeable batteries. Other types of batteries may burst, causing personal injury or damage.

# SYMBOLS

Some of the following symbols may be used on this tool. Please study them and learn their meaning. Proper interpretation of these symbols will allow you to operate the tool better and safer.

SYMBOL	NAME	DESIGNATION/EXPLANATION
	Wet Conditions Alert	Do not expose to rain or use in damp locations.
	Read The Operator's Manual	To reduce the risk of injury, user must read and understand operator's manual before using this product.
	Eye Protection	Always wear safety goggles or safety glasses with side shields and, as necessary, a full face shield when operating this product.
	Safety Alert	Precautions that involve your safety.

# FEATURES

## PRODUCT SPECIFICATIONS

Charger Voltage.....	9.6 Volt, 12 Volt, 14.4 Volt, and 18 Volt DC
Charger Input .....	120 V, 60 Hz, AC only
Charge Rate .....	30 minutes

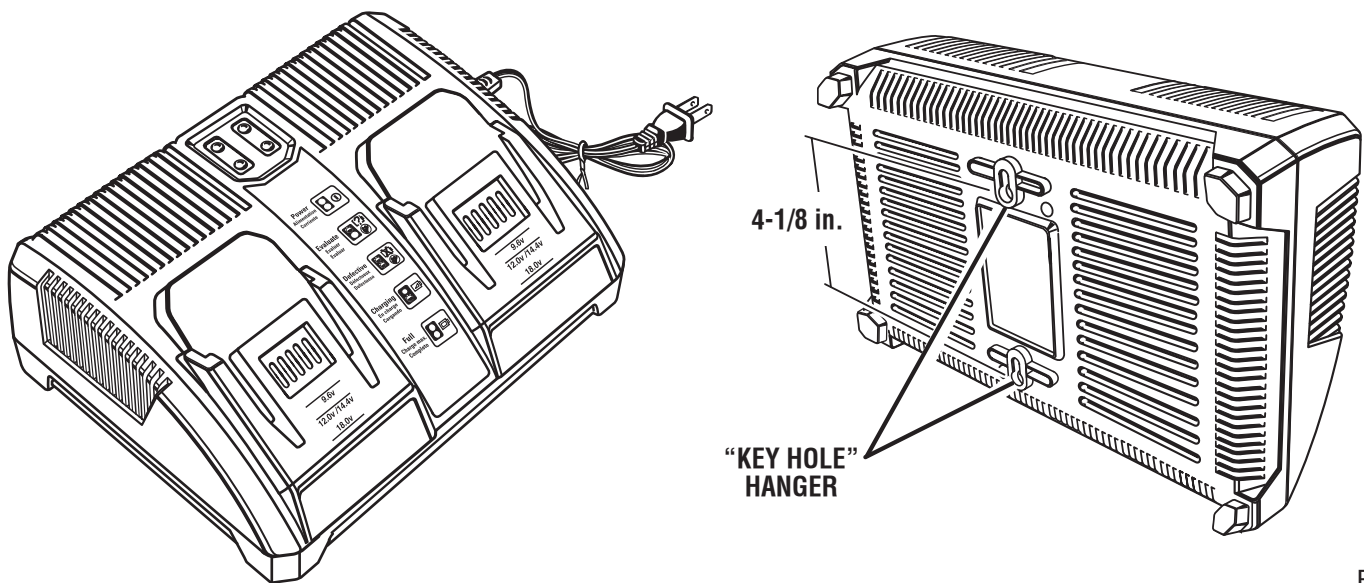

Fig. 1

## KNOW YOUR DUAL PORT CHARGER

See Figure 1.

Before attempting to use this product, familiarize yourself with all operating features and safety rules.

## AUTOMATIC FAN SHUT-OFF

Your dual port charger is fan-cooled. When a battery pack is fully charged (the green LED is on), the fan will automatically shut itself off.

## “KEY HOLE” HANGER

The charger has a “key hole” hanging feature for convenient, space saving storage. Screws should be installed so that the center distance is 4-1/8 in.

# OPERATION

## APPLICATIONS

You may use this tool for the following purposes:

- Charging 9.6 Volt, 12 Volt, 14.4 Volt, and 18 Volt RIDGID slide batteries

### CAUTION:

If at any point during the charging process none of the LEDs are lit, remove the battery pack from the charger to avoid damaging the product. DO NOT insert another battery. Return the charger and battery to your nearest service center for service or replacement.

## CHARGING THE BATTERY PACK

The battery pack for this tool has been shipped in a low charge condition to prevent possible problems. Therefore, you should charge it until the light on front of charger changes from flashing green to continuous green.

**NOTE:** Batteries will not reach full charge the first time they are charged. Allow several cycles (operation followed by recharging) for them to become fully charged. This is normal for nickel-cadmium batteries.

### TO CHARGE

- Charge the battery pack only with the charger provided.
- Make sure the power supply is normal household voltage, **120 volts, 60 Hz, AC only.**
- Connect the charger to a power supply.
- Attach the battery pack to the charger by aligning the raised ribs on the battery pack with the grooves in the charger, then slide the battery pack onto the charger. *See Figure 2.*
- The battery pack will become slightly warm to the touch while charging. This is normal and does not indicate a problem.
- Do not place the charger in an area of extreme heat or cold. It will work best at normal room temperature.
- For average charge times, refer to the chart on the following page.
- When the batteries become fully charged, unplug the charger from the power supply and remove the battery pack.

## CHARGING A HOT BATTERY PACK

When using the tool continuously, the battery pack will become hot. Because the dual port charger is fan-cooled, a hot battery pack may be placed directly onto the charger port. When placed on the charger, a hot battery pack will cool for 20 minutes or less before attempting to recharge.

If the battery pack is above normal temperature range, the red LED will begin flashing and the green LED will be off. When the battery pack cools down to approximately 104°F (40°C), the charger will automatically begin fast charge mode.

CHARGER SHOWN WITH 18 VOLT BATTERY PACK

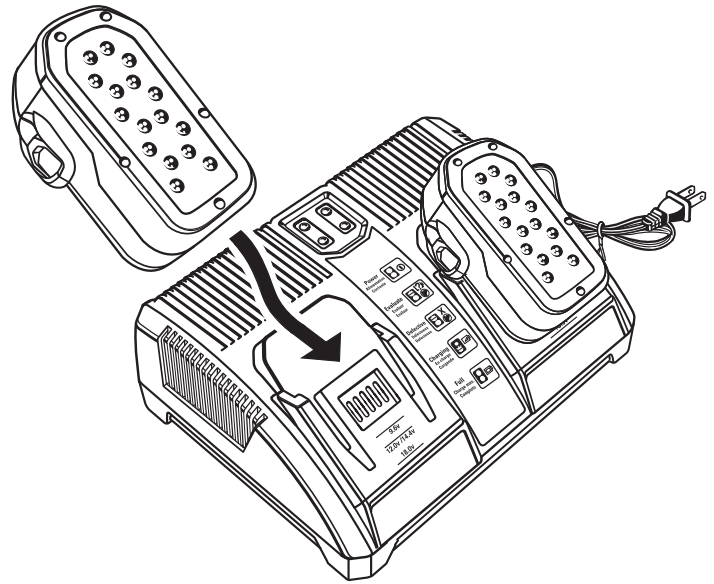

Fig. 2

**NOTE:** Refer to **CHARGING THE BATTERY PACK** for normal recharging of batteries. If the charger does not charge your battery pack under normal circumstances, return both the battery pack and charger to your nearest repair center for electrical check. For the location of your nearest repair center, please call 1-866-539-1710.

## CHARGING A COOL BATTERY PACK

If the battery pack is below normal temperature range, the red LED will begin flashing and the green LED will be off. When the battery warms to a temperature of more than 41°F (5°C), the charger will automatically begin fast charge mode.

**NOTE:** Refer to **CHARGING THE BATTERY PACK** for normal recharging of batteries. If the charger does not charge your battery pack under normal circumstances, return both the battery pack and charger to your nearest repair center for electrical check. For the location of your nearest repair center, please call 1-866-539-1710.

**USE THIS RIDGID BATTERY CHARGER ONLY WITH THE BATTERY PACKS LISTED BELOW.**

Part Number	Voltage	Part Number	Voltage
130252007	9.6	130254008	14.4
130252002	12	130252001	18
130254001	12	130252004	18
130252003	14.4	130254003	18
130254002	14.4	130254007	18

# OPERATION

## LED FUNCTION OF CHARGER

See Figure 3.

LED INDICATOR	BATTERY PACK	RED LED	GREEN LED	ACTION
<b>Power</b> Alimentation Corriente	Without battery pack	ON	OFF	Ready to charge battery pack
<b>Evaluate</b> Evaluer Evaluar	Hot battery pack	Flashing	OFF	When battery pack reaches cooled temperature, charger begins fast charge mode
	Cold battery pack	Flashing	OFF	When battery pack reaches warmed temperature, charger begins fast charge mode
	Deeply discharged	Flashing	OFF	Charger pre-charges battery until normal voltage is reached, then begins fast charge mode
<b>Defective</b> Défectueux Defectuoso	Defective	Flashing	Flashing	Battery pack or charger is defective <ul style="list-style-type: none"> <li>• If defective, try to repeat the conditions a second time by removing and reinstalling the battery pack. If the LED status repeats a second time, try charging a different battery.</li> <li>• If a different battery charges normally, dispose of the defective pack (see <i>Maintenance</i> section).</li> <li>• If a different battery also indicates “Defective,” the charger may be defective.</li> </ul>
<b>Charging</b> En charge Cargando	Fast charging	ON	Flashing	See chart below for charge times
<b>Full</b> Charge max. Completo	Slow charging	OFF	ON	Fast charging is complete Charger maintains charge mode

BATTERY	AVERAGE CHARGE TIME
COMPACT SERIES	18 min.
HC	27 min.
HC 2.5	34 min.

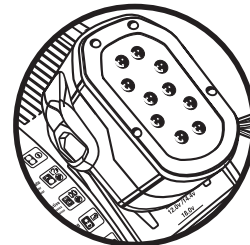
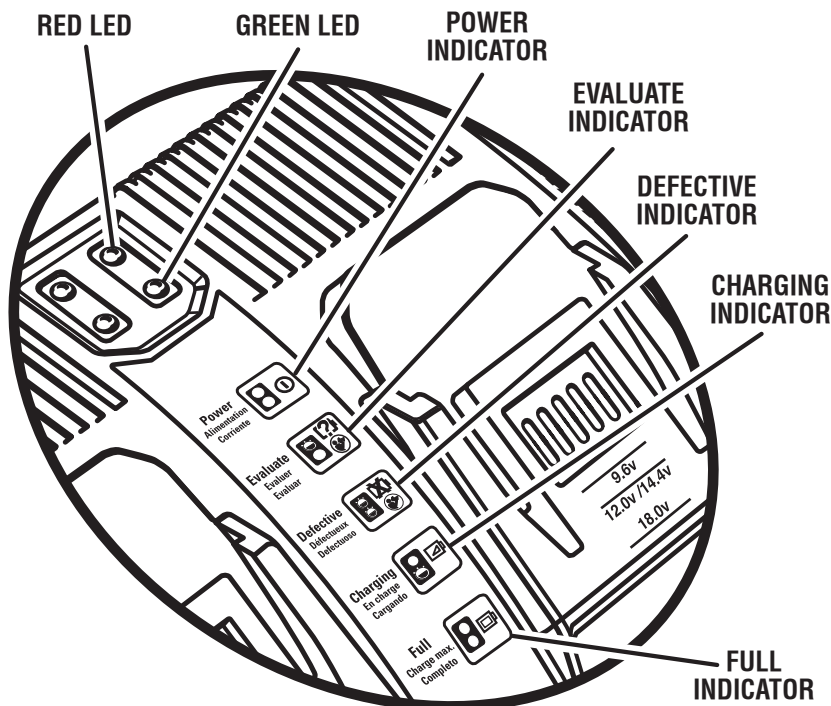

**NOTE:** The 9.6 Volt, 12 Volt, and 14.4 Volt battery packs will not slide all the way down onto the charger port. Insert 9.6 Volt, 12 Volt, and 14.4 Volt battery packs until they click into place and are aligned with the line on the charger, shown at left. Allow up to 5 seconds for the “charge” light to come on after the battery pack is inserted.

Fig. 3

# MAINTENANCE

---

## **WARNING:**

When servicing use only identical RIDGID replacement parts. Use of any other parts may create a hazard or cause product damage.

---

## **WARNING:**

Always wear safety goggles or safety glasses with side shields during power tool operation or when blowing dust. If operation is dusty, also wear a dust mask.

---

## **WARNING:**

To avoid serious personal injury, always remove the battery pack from the tool when cleaning or performing any maintenance.

---

## GENERAL MAINTENANCE

Avoid using solvents when cleaning plastic parts. Most plastics are susceptible to damage from various types of commercial solvents and may be damaged by their use. Use clean cloths to remove dirt, dust, oil, grease, etc.

---

## BATTERIES

The battery pack for this tool is equipped with nickel-cadmium rechargeable batteries. Length of service from each charging will depend on the type of work you are doing.

The batteries in this tool have been designed to provide maximum trouble-free life. However, like all batteries, they will eventually wear out. **Do not** disassemble battery pack and attempt to replace the batteries. Handling of these batteries, especially when wearing rings and jewelry, could result in a serious burn.

To obtain the longest possible battery life, we suggest the following:

- Remove the battery pack from the charger once it is fully charged and ready for use.

For battery pack storage longer than 30 days:

- Store the battery pack where the temperature is below 80°F.
- Store battery packs in a “discharged” condition.

## **WARNING:**

Do not at any time let brake fluids, gasoline, petroleum-based products, penetrating oils, etc., come in contact with plastic parts. Chemicals can damage, weaken or destroy plastic which may result in serious personal injury.

---

Only the parts shown on the parts list are intended to be repaired or replaced by the customer. All other parts should be replaced at a RIDGID authorized service center.

## KEEPING THE CHARGER VENTS CLEAN

The fan in this charger will perform more efficiently if the air vents and ports are kept clean and dust-free. Periodically check the air vents for dust or other debris.

To clean the vents, unplug the charger. Using a fine nylon-bristle brush, whisk dust or debris away from the air vents and ports.

The battery pack has intake and exhaust vents that should also be kept free of dust and debris. Clean the battery pack vents by using a fine nylon-bristle brush to whisk away dust or debris.

When cleaning, do not allow metal to come into contact with any of the vents or ports of the charger or battery pack.

---

## BATTERY PACK REMOVAL AND PREPARATION FOR RECYCLING



To preserve natural resources, please recycle or dispose of batteries properly.

This product contains nickel-cadmium batteries. Local, state or federal laws may prohibit disposal of nickel-cadmium batteries in ordinary trash.

Consult your local waste authority for information regarding available recycling and/or disposal options.

---

## **WARNING:**

Upon removal, cover the battery pack's terminals with heavy-duty adhesive tape. Do not attempt to destroy or disassemble battery pack or remove any of its components. Nickel-cadmium batteries must be recycled or disposed of properly. Also, never touch both terminals with metal objects and/or body parts as short circuit may result. Keep away from children. Failure to comply with these warnings could result in fire and/or serious injury.

---

# WARRANTY

---

## RIDGID® HAND HELD AND STATIONARY POWER TOOL 3 YEAR LIMITED SERVICE WARRANTY

Proof of purchase must be presented when requesting warranty service.

Limited to RIDGID® hand held and stationary power tools purchased 2/1/04 and after. This product is manufactured by One World Technologies, Inc. The trademark is licensed from RIDGID, Inc. All warranty communications should be directed to One World Technologies, Inc., attn: RIDGID Hand Held and Stationary Power Tool Technical Service at (toll free) 1-866-539-1710.

### 90-DAY SATISFACTION GUARANTEE POLICY

During the first 90 days after the date of purchase, if you are dissatisfied with the performance of this RIDGID® Hand Held and Stationary Power Tool for any reason you may return the tool to the dealer from which it was purchased for a full refund or exchange. To receive a replacement tool you must present proof of purchase and return all original equipment packaged with the original product. The replacement tool will be covered by the limited warranty for the balance of the 3 YEAR service warranty period.

### WHAT IS COVERED UNDER THE 3 YEAR LIMITED SERVICE WARRANTY

This warranty on RIDGID® Hand Held and Stationary Power Tools covers all defects in workmanship or materials and normal wear items such as brushes, chucks, motors, switches, cords, gears and even cordless batteries in this RIDGID® tool for three years following the purchase date of the tool. Warranties for other RIDGID® products may vary.

### HOW TO OBTAIN SERVICE

To obtain service for this RIDGID® tool you must return it; freight prepaid, or take it in to an authorized service center for RIDGID® branded hand held and stationary power tools. You may obtain the location of the authorized service center nearest you by calling (toll free) 1-866-539-1710 or by logging on to the RIDGID® website at [www.ridgid.com](http://www.ridgid.com). When requesting warranty service, you must present the original dated sales receipt. The authorized service center will repair any faulty workmanship, and either repair or replace any part covered under the warranty, at our option, at no charge to you.

### WHAT IS NOT COVERED

This warranty applies only to the original purchaser at retail and may not be transferred. This warranty only covers defects arising under normal usage and does not cover any malfunction, failure or defect resulting from misuse, abuse, neglect, alteration, modification or repair by other than an authorized service center for RIDGID® branded hand held and stationary power tools. Consumable accessories provided with the tool such as, but not limited to, blades, bits and sand paper are not covered.

**RIDGID, INC. AND ONE WORLD TECHNOLOGIES, INC. MAKE NO WARRANTIES, REPRESENTATIONS OR PROMISES AS TO THE QUALITY OR PERFORMANCE OF ITS POWER TOOLS OTHER THAN THOSE SPECIFICALLY STATED IN THIS WARRANTY.**

### ADDITIONAL LIMITATIONS

To the extent permitted by applicable law, all implied warranties, including warranties of MERCHANTABILITY or FITNESS FOR A PARTICULAR PURPOSE, are disclaimed. Any implied warranties, including warranties of merchantability or fitness for a particular purpose, that cannot be disclaimed under state law are limited to three years from the date of purchase. One World Technologies, Inc. and RIDGID, Inc. are not responsible for direct, indirect, incidental or consequential damages. Some states do not allow limitations on how long an implied warranty lasts and/or do not allow the exclusion or limitation of incidental or consequential damages, so the above limitations may not apply to you. This warranty gives you specific legal rights, and you may also have other rights which vary from state to state.

---

**One World Technologies, Inc.**

Hwy. 8

Pickens, SC 29671

---

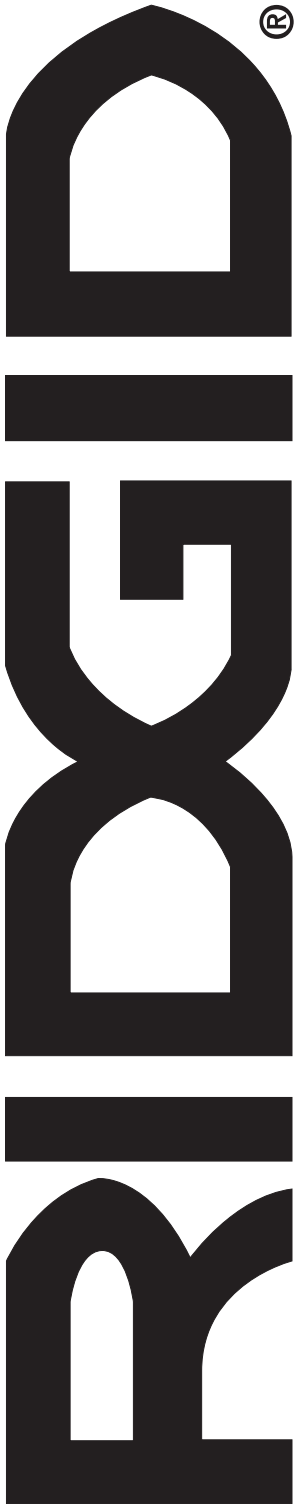

# OPERATOR'S MANUAL

## DUAL PORT BATTERY CHARGER

### 140276004

#### Customer Service Information:

For parts or service, contact your nearest RIDGID authorized service center. Be sure to provide all relevant information when you call or visit. For the location of the authorized service center nearest you, please call 1-866-539-1710 or visit us online at [www.ridgid.com](http://www.ridgid.com).

The model number of this tool is found on a plate attached to the motor housing. Please record the serial number in the space provided below. When ordering repair parts, always give the following information:

**Model No.** \_\_\_\_\_ 140276004 \_\_\_\_\_

**Serial No.** \_\_\_\_\_