

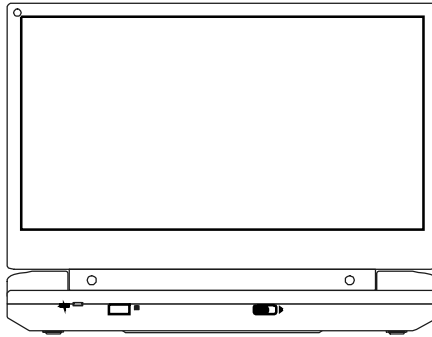

AUDIOVOX[®]
ELECTRONICS CORP.



D1915

PORTABLE DVD PLAYER AND 9" LCD MONITOR

	<p>For Customer Service Visit Our Website At www.audiovox.com Product Information, Photos, FAQ's Owner's Manuals</p>
-------------------------------------------------------------------------------------	-----------------------------------------------------------------------------------------------------------------------------------------------------------------------------------

Contents

A. Introduction	3
B. Cautions and Warnings	3
C. Contents	5
D. Powering and Installation	5
E. Controls, Indicators and Connectors	6
F. Loading and Playing a Disc	7
G. Basic Operation.....	8
H. Menu	9
I. Display.....	9
J. Playing Audio CDS.....	12
K. Playing MP3 Discs	13
L. Playing JPG file	15
M. Connecting to Other Electronic Equipment.....	17
N. Setup	19
O. Specifications	28
P. Rechargeable Battery Installation and Use	28
Q. Troubleshooting	31

A. Introduction

Thank you for choosing the D1915 portable DVD player. The main features include a 9" Wide Screen (16:9 Aspect Ratio) Liquid Crystal Display (LCD) monitor and a DVD player. The unit applies the latest state of the art electronics and is designed for use in hotels, offices, vehicles or your home. The unit is constructed to provide years of reliable, trouble-free service, and is compact so that you can take it with you anywhere and is designed for quick and easy installation. Please read the entire instruction manual supplied with this product prior to using. The documentation will assist you in installing the system properly to obtain the best equipment performance. Please save this manual for later use.

B. Cautions and Warnings

1. Placement

To prevent fire or electric shock, do not expose this appliance to rain or moisture. Do not place the set on an unstable cart, stand, tripod, bracket or table to prevent it from falling. Keep the unit away from strong magnets, heat sources, direct sunlight, excessive dust. If the unit is brought directly from a cold to a warm location, moisture may condense inside the unit. When you move it from a cold to a warm location, wait for about one hour before operating the unit, or remove the disc and leave the unit turned on until the moisture evaporates.

2. Installation

Ensure that the D1915 is installed in accordance with the instructions and illustrations provided in this manual.

3. Caution

Do not push objects of any kind into the unit through openings; do not spill or spray liquid of any kind on or in the system (this may result in a fire or electric shock). Do not place anything heavy on the unit. To ensure proper ventilation and proper

operation, never cover or block the slots and openings with a cloth or other material. Keep the unit away from an open flame such as fire, candle etc. It is hazardous to replace the battery incorrectly. Replace the battery only with the same or equivalent type, in order to protect the environment, please dispose of the battery properly. Do not use the unit in temperatures higher than 95 degrees Fahrenheit or 35 degrees Celsius.

4. Disassembly

Do not attempt to disassemble the cabinet. There is a risk of electric shock and/or exposure to Laser Radiation. Contact qualified service personnel if your system needs repair.

5. Cleaning

When cleaning, make sure the system is unplugged from the power source. Do not use liquid cleaners or aerosol cleaners. Use a cloth lightly dampened with water for cleaning the exterior of the system only.

6. Disc

Do not use irregularly shaped discs such as heart or star-shaped discs as they may cause the unit to malfunction. Do not stick paper, tape or glue on the disc. Do not expose the disc to direct sunlight or heat sources. Do not touch the surface of disc. Handle the disc by its edge. Clean the disc by wiping the disc from the center out with a cleaning cloth. Remove the disc from the unit and store it in its case after playing. Some playback operations of discs may be intentionally fixed by software producers. Since this unit plays discs according to the disc contents the software producers designed, some playback features may not be available. Also refer to the instructions supplied with the discs.

7.Regional Coding

Both the DVD player and discs are coded by region. These regional codes must match in order for the disc to play. If the codes don't match, the disc won't play. This unit's code is region 1. DVDs with other regional codes can not be played in this unit

C. Contents

1. 1 x 9" LCD Monitor & DVD Player Combo
2. 1 x Remote Control with battery (CR2025)
3. 1 x Audio/Video Adapter Cable
4. 1 x AC to DC Adapter
5. 1 x DC Power Adapter
6. 1 x Instruction Manual
7. 1 x Rechargeable Battery

D. Powering and installation

1. Powering the system indoors (Refer to Figure 1)

Plug one end of the AC to DC adapter into the DC input jack on the left side of the main unit, then plug the other end into a 110~240V AC power receptacle.

2. Powering the system in a car

Plug one end of the DC power adapter into the DC input jack on the left side of the main unit, then plug the other end into the vehicle power outlet.

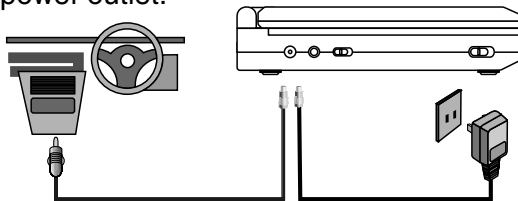

Figure 1

E. Controls, Indicators, and Connectors

1. Unit View (Refer to Figure 2)

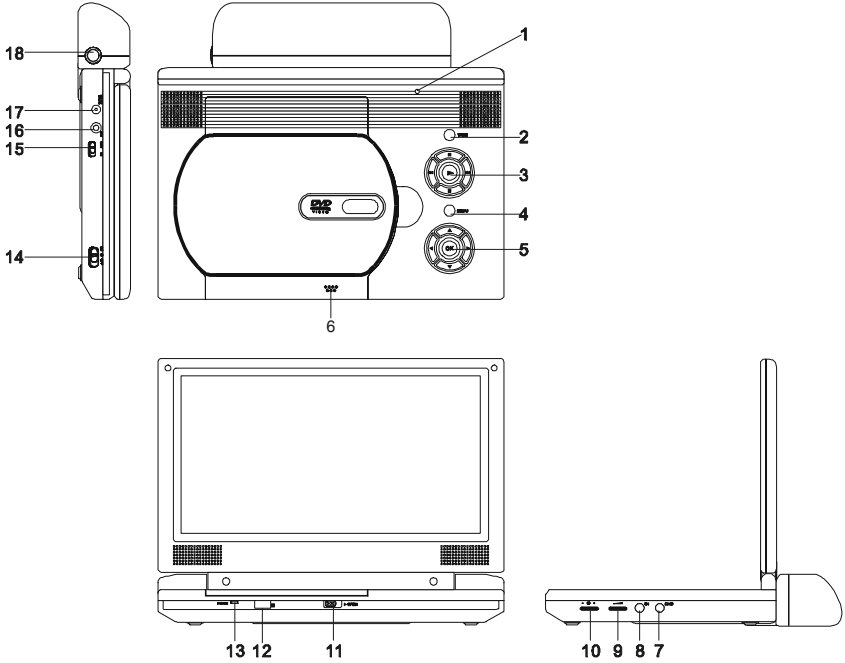

Figure 2

- | | |
|-----------------------------------------|----------------------------|
| 1) LCD Panel Shut Off Switch | 9) Volume Control |
| 2) Wide Button | 10) Brightness Control |
| 3) Previous/Next/Pause/Stop Play Button | 11) Door Open Switch |
| 4) Menu Button | 12) Remote Control Sensor |
| 5) Up/Down/Left/Right/OK Button | 13) Power LED |
| 6) Press to close | 14) Power On/Off Switch |
| 7) Headphone Jack 1 | 15) AV in/out SW |
| 8) Headphone Jack 2 | 16) AV Jack |
| | 17) DC 9-12V Input Jack |
| | 18) Battery Release Button |

2. Remote Control (Refer to figure 3)

- 1) Setup Button
- 2) Up Button
- 3) Previous Button
- 4) Enter Button
- 5) Reverse Scan/Left Button
- 6) DOWN Button
- 7) Numeric Button
- 8) Display Button
- 9) Zoom Button
- 10) Subtitle Button
- 11) Next Button
- 12) A-B Repeat Button
- 13) Forward Scan/Right Button
- 14) 1/All Repeat Button
- 15) Stop Button
- 16) Menu Button
- 17) Audio Button
- 18) Angle Button
- 19) Play/Pause Button

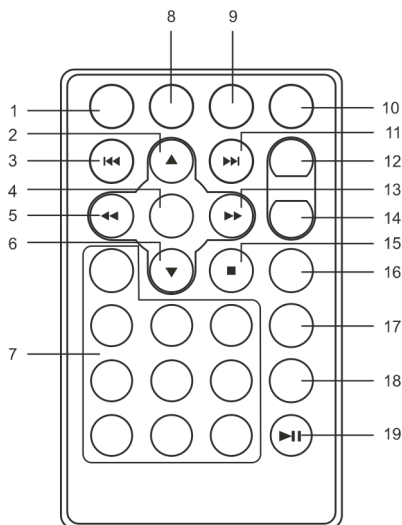

Figure 3

F. Loading and Playing a Disc

- a. After connecting power to the unit, turn on the DVD player with the power switch. The power indicator will light.
- b. Open the disc tray by sliding the OPEN switch to the right. Place a disc into the tray with the label side facing up.
- c. Close the tray by pressing the area marked "PRESS". The unit will load the disc and start playing.
- d. Adjust the BRIGHTNESS and VOLUME to the desired levels.
- e. To stop playing a disc, press STOP.

G. Basic Operation

POWER	Turn the unit on/off
OPEN	Remove/load the disc
PLAY	Start Play/Confirm item or setting
SLOW	Play at 1/2, 1/4, 1/8 or 1/16 normal speed
PAUSE	Still Picture
STOP	(1 time) Stop at the present playing point / (2 times) Stop playing
NEXT	Go to the next chapter, track or scene during play back
PREVIOUS	Go back to the previous chapter, track or scene during play back
FORWARD	Scan forward at 2, 4, 8, 16 or 32 times speed
REVERSE	Scan backward at 2, 4, 8, 16 or 32 times speed
LEFT/RIGHT/UP/DOWN	Used for Menu Navigation
ENTER	Execute item or confirm setting
NUMBERS	Select item or setting
MENU	Display the main menu of the disc
REPEAT	Repeat playing title, chapter, or track
A-B	Repeat a specific portion from point A to point B of the disc
DISPLAY	Display information (title, chapter, track, time, etc.).
ANGLE	Change the viewing angles
SUBTITLE	Select the subtitle language and turn it on/off
AUDIO	Select the audio language
ZOOM	Enlarge an image to 2, 3, or 4 times the original size.
SETUP	Display the setup menu to select and set items, and exit the setup menu.

H. Menu

A DVD is divided into sections called titles and chapters. When you play a DVD, a root menu of the disc will appear on the screen of your TV or Monitor. The contents of the menu vary from disc to disc. Press MENU during playback to display the menu. Some DVDs only allow you to select disc playback options using the DVD root menu.

I. Display

1. PLAYING TIME AND REMAINING TIME

- a. During playback press the 'DISPLAY' button to display the current Title Number (1), the total Number of Titles (2), the current Chapter Number (3), the total Number of Chapters (4), and the Playing elapsed Time for the title (5). The heading will disappear automatically after 3 seconds if DISPLAY button is not pressed.

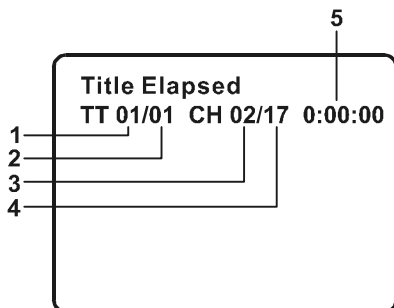

Title, Chapter Number, and Time Screen Display

- b. Press 'DISPLAY' repeatedly to choose from the options below :

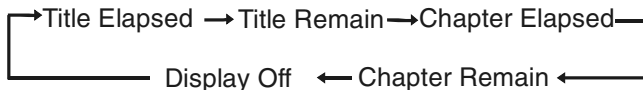

2. ANGLE

During playback of a disc, press 'ANGLE' to display the available angles for discs containing multi-angles*, with the current angle number (1) and the total number of angles (2) displaying. Press 'ANGLE' to select another angle, then press again to exit and return to the normal viewing angle. The angle display will disappear automatically if the 'ANGLE' button is not pressed again within 3 seconds.

***NOTE:** Not all discs contain this feature.

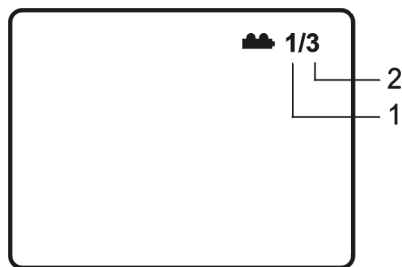

Angle

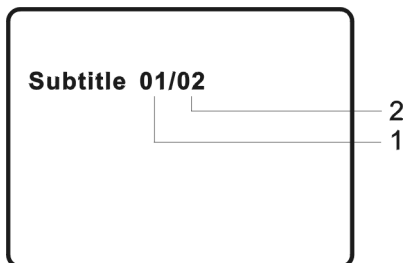

Subtitle

3. SUBTITLE

During disc playback press 'SUBTITLE' to select the subtitle language you desire*, with the current Subtitle Language Number (1) and the total Number of Subtitle Languages (2) displayed. If there are multiple languages press 'SUBTITLE' again to select another subtitle language. To turn subtitles OFF, press the 'SUBTITLE' button until 'Subtitle Off' is displayed. The Subtitle display will disappear automatically if the 'SUBTITLE' button is not pressed again within 3 seconds.

* Some DVDs only allow access to this function through the DVD menu

4. AUDIO

During playback press 'AUDIO' to select the audio language you desire*, with the current Audio Channel Number (1) and the total number of Audio Channels (2) displayed. Press AUDIO again to select another audio language. The audio display will disappear automatically if the 'AUDIO' button is not pressed within for 3 seconds.

* Some DVDs only allow access to this function through the DVD menu.

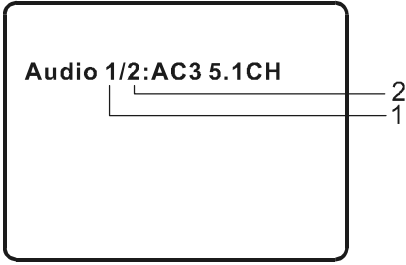

Audio Language

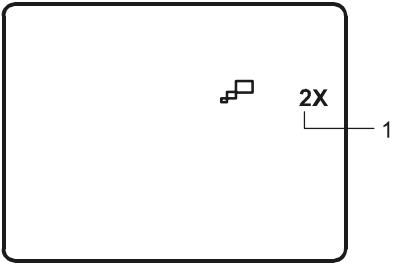

Zoom

5. ZOOM

During playback press 'ZOOM' to enlarge the picture by 2X, 3X or 4X.

- (1) Press "zoom" one time, the picture will be enlarged 2X.
- (2) Press "zoom" a second time, the picture will be enlarged 3X.
- (3) Press "zoom" a 3rd time, the picture will be enlarged 4X.
- (4) Press "zoom" a 4th time, the picture will return to normal size.

6. A-B REPEAT

- a. During playback press a first time 'A-B' to set the Starting Point A.
- b. Press 'A-B' a second time to set the Ending Point B and the player will repeatedly play the part between Point A and Point B.
- c. Press A-B a third time to cancel A-B repeat and resume normal playback.

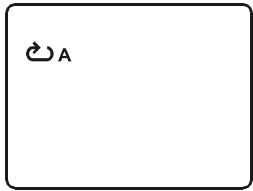

A-B Repeat Starting Point



A-B Repeat Ending Point



A-B Repeat Cancelled

7. REPEAT

a. During playback press 'REPEAT' to select see the repeat mode desired.

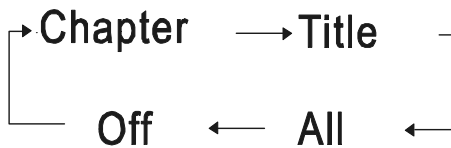

DVD Repeat Mode

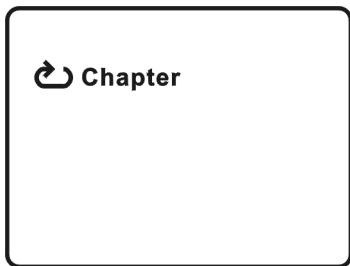

Chapter Repeat

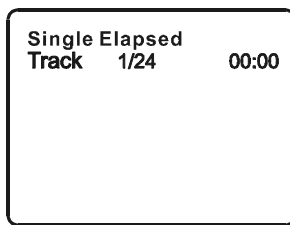

Single Elapsed Time When
Playing Audio CDs

J. Playing Audio CDs

When playing an audio CD press the DISPLAY button on the remote to view time playback information. The options below appear on the display:

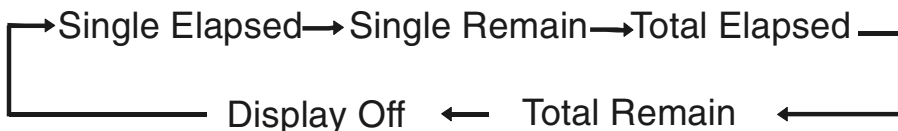

CD Display Mode

Single Elapsed: The current track playing and playing time of that track will display on the screen.

Single Remain: The current track playing and the amount of time left.

- Total Elapsed: The current track playing and the total time that the CD has been playing.
- Total Remain: The current track playing and the amount of time remaining on the CD.
- Display Off: The CD time Information will not be displayed.

USING THE REPEAT FEATURE

The default mode for the Repeat feature is OFF. Pressing REPEAT consecutively changes the repeat options:

- *Track-* repeats the track that is playing.
- *All-* repeats the disc that is playing.
- *Off*

As you toggle through the options, the repeat option changes. The selected repeat option loops repeatedly until you turn it off.

K. Playing MP3 Discs

MP3 is a format for storing digital audio. An audio CD-quality song is compressed into the MP3 format with very little loss of audio quality while taking up much less disc space. CD-R /RW discs that have been encoded in MP3 format are compatible with this system.

When a MP3 disc is inserted into the unit, the menu screen will appear automatically. You can use the menu screen to select your desired folders and songs.

1. Press the ▲ or ▼ button to choose a folder from the folder list on the left side of the screen.
2. Press ENTER to select the highlighted folder. The songs available under the folder will be listed.
3. Use ▲ or ▼ button to choose a song from the list. Press ENTER to select and begin playback of the highlighted song.

4. Use the ►► (NEXT) button to move to the next song. Press the ◀◀ (PREVIOUS) button to move to the beginning of the previous song.

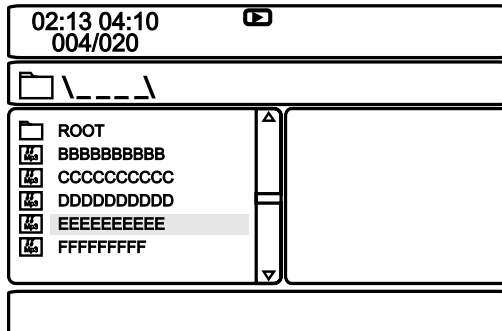

USING THE REPEAT FEATURE

The default mode for the Repeat feature is OFF. Pressing REPEAT consecutively changes the repeat options:

- Single
- Repeat One (repeat playback of a song)
- Repeat Folder (repeat playback of a specific folder)
- Repeat Off (normal playback)

As you toggle through the options, the repeat mode changes. The selected repeat mode loops repeatedly until you turn it off.

NOTICE

- “” icon in front of a file name indicates that this is a folder, not an MP3 file.
- “MP3” icon in front of a file name indicates that this is a MP3 file.

L. Playing JPEG file

- 1) Load the JPEG Disc into tray.
- 2) Select JPEG file by pressing “UP/DOWN” button.
- 3) You can preview the JPEG file by pressing “Play” or “ENTER”.
- 4) Pressing the “Left Key“ will rotate the picture counterclockwise.
Pressing the “Right Key“ will rotate the picture clockwise.
- 5) When browsing the photos, you can reverse the photo horizontally by pressing “Up” key, or you can reverse the photos vertically by pressing “Down” key.
- 6) When you browse the JPEG file, pressing “display” will change the refresh mode below.
 - a. Press “display” first time, “WIPE TOP” will display on the screen, the picture will refresh from top to bottom.
 - b. Press “display” 2nd time, “WIPE BOTTOM” will display on the screen, the picture will refresh from bottom to top.
 - c. Press “display ” 3rd time, “WIPE LEFT” will display on the screen, the picture will refresh from left side to right side.
 - d. Press “display ” 4th time, “WIPE RIGHT” will display on the screen, the picture will refresh from right side to left side.
 - e. Press “display” 5th time, “DIAGONAL WIPE LEFT TOP” will display on the screen, the picture will refresh from left top to right bottom.
 - f. Press “ display ” 6th time, “DIAGONAL WIPE RIGHT TOP” will display on the screen, the picture will refresh from right top to left bottom.
 - g. Press “display ” 7th time, “DIAGONAL WIPE LEFT BOTTOM” will display on the screen, the picture will refresh from left bottom to right top.
 - h. Press “display ” 8th time, “DIAGONAL WIPE RIGHT BOTTOM” will display on the screen, the picture will refresh from right bottom to left top.

- i. Press “display” 9th time, “EXTEND FROM CENTER H” will display on the screen, the picture will refresh from horizontal center to both sides.
 - j. Press “display” 10th time, “EXTEND FROM CENTER V” will display on the screen, the picture will refresh from vertical center to both sides.
 - k. Press “display” 11th time, “COMPRESS TO CENTER H” will display on the screen, the picture will refresh from top and bottom to center.
 - l. Press “display” 12th time, “COMPRESS TO CENTER V” will display on the screen, the picture will refresh from right and left to center.
 - m. Press “display” 13th time, “WINDOW H” will display on the screen, the picture will refresh from four window’s top side to bottom side.
 - n. Press “display” 14th time, “WINDOW V” will display on the screen, the picture will refresh from four window’s left side to right side.
 - o. Press “display” 15th time, “WIPE FROM EDGE TO CENTER” will display on the screen, the picture will refresh from 4 edges to center.
- 7) When previewing the file, pressing “ANGLE, SUBTITLE, AUDIO, NUMBER, AB, RETURN, REW/FF, SLOW” a hand icon will appear on the display meaning that these options are not available.
 - 8) Press “Stop” to browse the JPEG file, “SLIDE SHOW MENU” will be displayed on the screen.
 - 9) When browsing the picture, press “Stop” and thumbnail size pictures will be displayed. You can select the picture you desire by using the UP/DOWN/LEFT/RIGHT/ENTER key.
 - 10) Press “Play” or “OK”, to preview the picture.

M. Connecting to Other Electronic Equipment

1. Connecting to a TV or another monitor (Refer to Figure 4)

- Position the AV In/Out Switch to the “Out” Position.
- Connect one end of the audio/video adapter cable’s black (1/8” plug) plug into the unit’s DVD AV jack, and connect the other end to a standard A/V Cable (purchased separately). Then connect the A/V Cable to the INPUT jacks on your TV or Monitor.
(white = left channel, red = right channel, yellow=video).

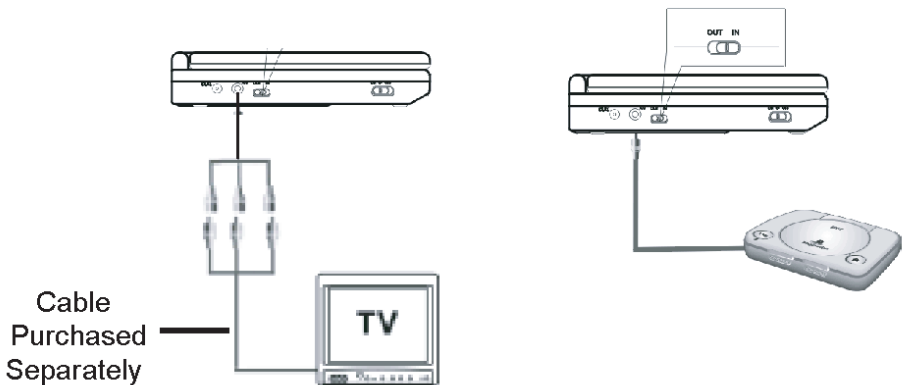

Figure 4

2. Connecting to a Game or Camcorder (Refer to Figure 4)

- Position the AV In/Out Switch to “In” Position.
- Connect one end of the audio/video adapter cable’s black (1/8” plug) plug into the unit’s DVD AV jack, and connect the other end to the A/V output jacks on your Camcorder or Game.
(white = left channel, red = right channel, yellow=video).

3. Headphone

Optional wired headphones may be used with the unit. Simply plug in the headset to either Headphone 1 jack or Headphone 2 jack on the right side of the DVD. (Refer to Figure 5)

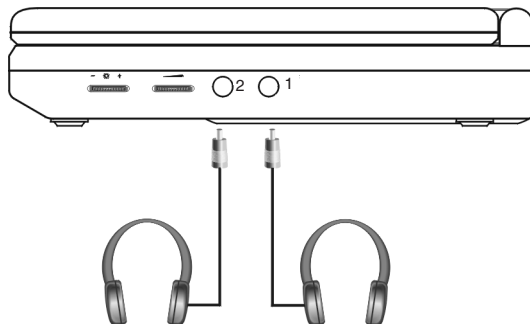

Figure 5

Plugging into Headphone jack 1 disables the internal speakers.

Notice:

1. This Product incorporates copyright protection technology that is protected by method claims of certain U.S. Patents and other intellectual property rights owned by Macrovision Corporation and other rights owners. Use of this copyright protection technology must be authorized by Macrovision Corporation, and is intended for home and other limited viewing uses only unless otherwise authorized by Macrovision Corporation. Reverse engineering or disassembly is prohibited.

2. Apparatus Claims of U.S. Patent Nos. 4,631,603; 4,577,216; 4,819,098 and 4,907,093 licensed for limited viewing uses only.

N. Setup

Press 'SETUP' to display the Main screen of the Setup Menu on the screen. Press 'SETUP' again to exit the Setup Menu and the unit will resume it's last playback mode.

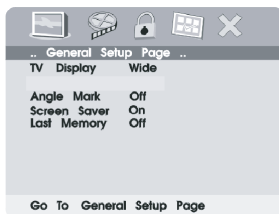

Main Setup Menu Screen

- 1) Press "SETUP", the 'General Setup Page' will be displayed.
 - a). Select 'TV Display' using the UP/DOWN button, and then press RIGHT to enter the submenu. Select the TV display mode desired using UP/DOWN, and press ENTER to confirm the setting. Press LEFT to return.
 - * Normal/PS: When the player is connected to a normal TV, and a wide picture is shown on the full screen.
 - * Normal/LB: When the player is connected to a normal TV, and a wide picture is shown on the screen with a black strip at both the top and bottom of the screen.
 - * Wide: When the player is connected to a wide screen TV, a wide picture is shown on the full screen.

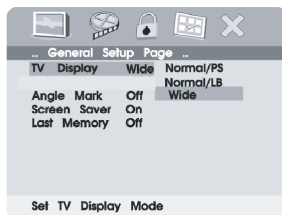

TV Display Screen Display

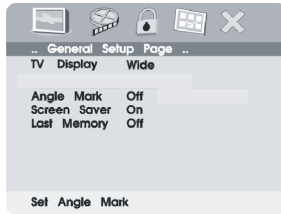

TV Type Screen Display

b).Select 'Angle Mark' using the UP/DOWN button, and then press the RIGHT button to enter the submenu. Choose Angle Mark on or off using the UP/DOWN button and then press ENTER to confirm the setting. Press the LEFT button to return.

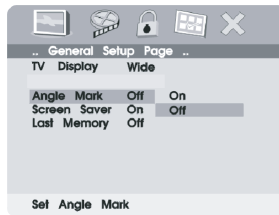

Angle Mark Screen Display

- * On: The screen will show the angle mark icon. (*If an angle option is available).
- * Off: The screen will not display the Angle Mark Icon

- c). Select 'Screen Saver' using the UP/DOWN button, and then press the RIGHT button to enter the submenu. Choose Screen Saver on or off using the UP/DOWN button and then press ENTER to confirm the setting. Press the LEFT button to return.

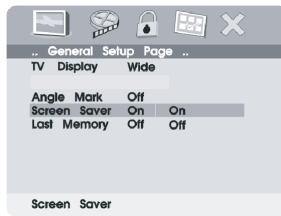

Screen Saver Screen Display

*On: Enables screen saver

*Off: Disables screen saver (off)

***NOTE:** The DVD player will enter the Screen Saver mode after approximately five minutes if the same image remains on the screen.

- d. Select "Last Memory" by using the UP/DOWN button.

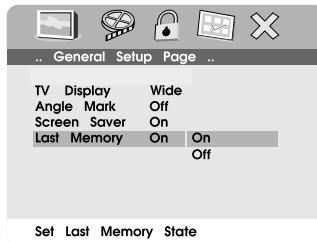

Last Memory Screen Display

*on: The unit will return to the last position on the disc.

*off: The unit will not return to the last position on the disc.

Note: The Last position memory function will only work when the power is on.

- 2) Select the “Video Quality Setup” page by using the LEFT/RIGHT buttons. Press “Enter” to enter the video quality set up page.



Main SETUP Menu VIDEO QUALITY

- a).Select “Brightness by using the UP or DOWN buttons, then press “Enter”. You can change the Brightness by pressing the LEFT or RIGHT buttons. To exit “Brightness Setting”, press “Enter” again to return to the main Menu.

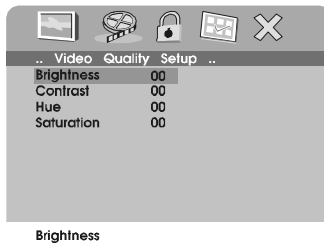

BRIGHTNESS Screen Display

- b).Select “Contrast” by using the UP or DOWN buttons, then press “Enter”. You can adjust the Contrast by pressing the LEFT or RIGHT buttons. To exit “Contrast Setting”, press “Enter” again to return to the main menu.

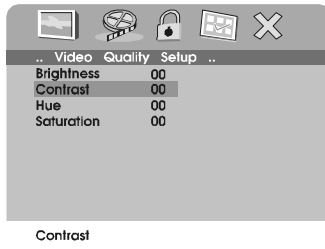

CONTRAST Screen Display

c).Select “Hue” (Tint) by using the UP or DOWN buttons, then press “Enter”. You can adjust the Hue by pressing the LEFT or RIGHT buttons.

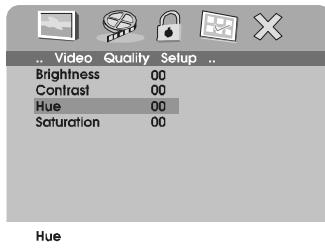

HUE (Tint) Screen Display

To exit “Hue” (Tint) Setting, press “Enter”again to return to the main Menu.

d).Select “Saturation” (color) by using the UP or DOWN buttons, then press “Enter”. You can adjust the Saturation by pressing the LEFT or RIGHT buttons.

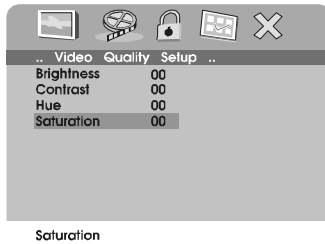

SATURATION (Color)Screen Display

To exit “Saturation” (color), press “Enter”again to return to the main Menu.

3).With no disc inside the player select “password” using the LEFT or RIGHT buttons, press ‘ENTER’ to enter the password setup page, then press the RIGHT button to enter the submenu .



Change Password

PASSWORD CHANGE Menu

Press ‘ENTER’ to enter the Password Change Page. Input the Old Password or the Default Password, the New Password, and the Confirmed New Password. Press ‘ENTER’ to confirm the change.



PASSWORD VERIFY Input Screen Display

NOTE: The Default Password is **3308**. This password is always effective even after you have selected your own password and changed it. To avoid the possibility of others using the default password to set the parental level and change the password, you can record this default password in another area and delete it from this manual. Some discs can be limited depending on the age of users while some discs cannot.

- 4). With no disc in the player select 'PREFERENCES' using the LEFT or RIGHT buttons, then press 'ENTER' to enter the preferences page.
- a. Select 'AUDIO' using the DOWN button, then press 'RIGHT' to enter the submenu. Select the audio language you desire using the UP or DOWN buttons, then press 'ENTER' to confirm the setting. Press LEFT to return.

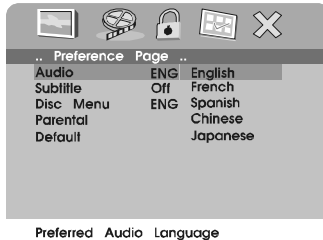

Preference Audio Language

- b. Select 'SUBTITLE' using the DOWN button, then press RIGHT to enter the submenu. Select the desired subtitle language or SUBTITLE OFF using the UP or DOWN buttons , then press 'ENTER' to confirm the setting. Press 'LEFT' to return.



Preference SUBTITLE LANGUAGE

Note: Language and subtitle selection is only available for discs that are recorded in the above listed languages. If the selected, language is not available, the player will play and display on the screen the original recorded language contained in the disc.

- c. Select 'DISC MENU' using the DOWN button, then press 'RIGHT' to enter the submenu. Select the Disc Menu Language you desire using the UP or DOWN buttons, then press 'ENTER' to confirm the setting. Press 'LEFT' to return.

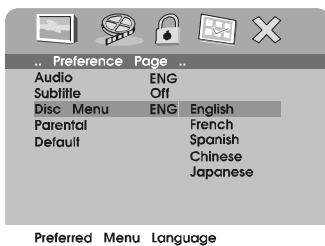

Preference DISC MENU LANGUAGE

- d. Select 'PARENTAL' using the DOWN button, then press RIGHT to enter the submenu.

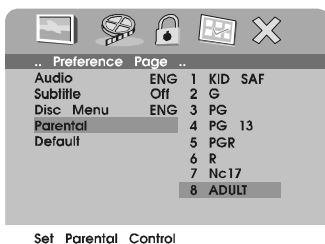

PARENTAL Preference Screen Display

Select the parental level you desire using the UP or DOWN buttons for discs with lock-out feature. These are listed from the lowest level (1 Kid Safe) to the highest level (Adult). Enter a 4 digit password, then press 'ENTER' to confirm the parental level setting.

NOTE: The level of 8 Adult is the factory default.

- e. Select 'DEFAULT' using the DOWN button, then press RIGHT to enter the submenu. Press ENTER to make all of the settings return to the factory-set mode.

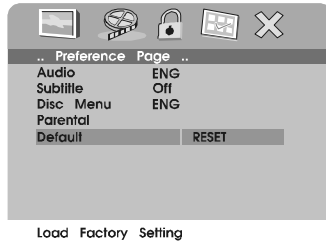

Loading Factory Setting

NOTE: The parental setting is not affected by the default reset function.

O. Specifications

Compatible DISC: DVD/CD/MP3/JPEG

Signal system: NTSC

Panel size: 9 inch

Frequency response: 20 Hz to 20 kHz

Video output: 1 Vp-p/75 Ohm, unbalanced

Audio output: 1.4V_{rms}/10kOhm

Audio S/N: Better than 60 dB

Dynamic range : Better than 85 dB

Laser: Semiconductor Laser, Wave Length: 650 nm/795 nm

Power source: DC 9-12VDC

Power consumption: 12 W

Operating temperature: 5~35°C

Weight : 0.94 kg

Dimensions (W x D x H): 9.41 X 6.26 X1.34inches
239 x 159 x 34mm

Battery Type: Ni-Mh

P. Rechargeable Battery Installation and Use

The player utilizes a set of long-life Ni-Mh batteries for a portable power supply. Ni-Mh batteries feature high storage capacity and low level of degradation. This means the Ni-Mh batteries do not have “Memory Effect” and thus can be recharged safely regardless of whether the battery is fully or only partially discharged. Please fully charge the battery prior to first use. Ensure that the battery has been charged for at least eight hours prior to connecting it to the DVD player for the first time.

NOTE:

If you plan not to use the battery for an extended period of time (one week or longer), we recommend that you first fully charge the battery and store it away properly. For longer periods of storage, please recharge the battery at least once every two months to maintain the

battery in optimum condition. Under no circumstances short the battery terminals, store the battery in a metal container, or leave the battery in a humid or damp environment. Ideally, store the battery in an airtight container with desiccant or other dehumidifying agent. Each full recharge takes approximately five-hours and one full charge can provide power to the player for at least 2 hours.

During recharge, the red indicator will stay on. Once fully recharged, the indicated LED on the right side of the unit will turn off. At this point you may remove the wall plug and stop charging.

Precautions related to Battery Recharge:

1. Once the battery is fully discharged, immediately recharge (regardless of whether you plan to use battery or not) in order to maximize battery life.
2. Recharge efficiency will degrade when environmental temperatures drop below 50°F (10°C) or exceed 95°F (35°C).
3. Please remove battery from the player and store it properly if the player is not to be used for long time. During this period, please recharge the battery at least once two months to avoid irreparable damage to the battery.

Using your Rechargeable Batteries

1. Please make sure you always use **only** the AC adapter included with the player to recharge your batteries, the DC power adapter can't be used to recharge the battery.
2. To charge the battery, please connect the power jack directly into the DVD player and leave the POWER switch in the OFF position.

Installing the Battery Pack:

1. First, make sure the player is in the “Power Off” mode and that the AC power supply has been disconnected.
2. Flip down the monitor.
3. Push the battery towards the rear of the player until it locks into position. The lock position is indicated by a click. The battery will fit snugly to the player.



Figure 6. Installing the DVD Player Battery

Removing the Battery Pack:

1. First, make sure the player is in the “Power Off” mode.
2. Press the release button on the side of battery.
3. Pull the battery from the rear of the player.



Figure 7. Removing the DVD Player Battery

Q. Troubleshooting

PROBLEM	SOLUTION
No sound or distorted sound	<ul style="list-style-type: none">• Make sure your DVD player is connected properly. Make sure all cables are securely inserted into the appropriate jacks.
Can't advance through a movie	<ul style="list-style-type: none">• You can't advance through the opening credits and warning information that appears at the beginning of movies because the disc is programmed to prohibit that action.
The icon () appears on screen	<p>The feature or action cannot be completed at this time because:</p> <ol style="list-style-type: none">1. The disc's software restricts it.2. The disc's software doesn't support the feature (e.g., angles)3. The feature is not available at the moment.4. You've requested a title or chapter number that is out of range.
Picture is distorted	<ul style="list-style-type: none">• The disc might be damaged. Try another disc.• It is normal for some distortion to appear during forward or reverse scan.
No forward or reverse scan	<ul style="list-style-type: none">• Some discs have sections that prohibit rapid scanning or title and chapter skip.• If you try to skip through the warning information and credits at the beginning of a movie, you won't be able to. This part of the movie is often programmed to prohibit skipping through it.

Troubleshooting (Cont)

PROBLEM	SOLUTION
IR sensor inoperative	<ul style="list-style-type: none">• Verify that the batteries in the remote are fresh.• Verify that the remote sensor eye is not obstructed.
Disc won't play	<ul style="list-style-type: none">• Insert a disc with the label side facing up.• Check the type of disc you put into disc tray. This DVD only plays DVDs, audio CDs, MP3s and JPEG discs.
Play starts, but then stops immediately	<ul style="list-style-type: none">• Both the unit and the disc are coded by region. If the regional codes don't match, the disc can't be played. This DVD is Region Number 1.• The disc is dirty. Clean it.• Condensation has formed. Allow player to dry out.



AUDIOVOX
ELECTRONICS CORP.

90 DAY LIMITED WARRANTY

Applies to Audiovox Video Products

AUDIOVOX ELECTRONICS CORP. (the Company) warrants to the original retail purchaser of this product that should this product or any part thereof, under normal use and conditions, be proven defective in material or workmanship within 90 days from the date of original purchase, such defect(s) will be repaired or replaced with reconditioned product (at the Company's option) without charge for parts and repair labor.

To obtain repair or replacement within the terms of this Warranty, the product is to be delivered with proof of warranty coverage (e.g. dated bill of sale), specification of defect(s), transportation prepaid, to the Company at the address shown below.

This Warranty does not extend to the elimination of externally generated static or noise, to correction of antenna problems, to costs incurred for installation, removal or reinstallation of the product, or to damage to tapes, discs, speakers, accessories, or electrical systems.

This Warranty does not apply to any product or part thereof which, in the opinion of the Company, has suffered or been damaged through alteration, improper installation, mishandling, misuse, neglect, accident, or by removal or defacement of the factory serial number/bar code label(s). THE EXTENT OF THE COMPANY'S LIABILITY UNDER THIS WARRANTY IS LIMITED TO THE REPAIR OR REPLACEMENT PROVIDED ABOVE AND, IN NO EVENT, SHALL THE COMPANY'S LIABILITY EXCEED THE PURCHASE PRICE PAID BY PURCHASER FOR THE PRODUCT.

This Warranty is in lieu of all other express warranties or liabilities. ANY IMPLIED WARRANTIES, INCLUDING ANY IMPLIED WARRANTY OF MERCHANTABILITY, SHALL BE LIMITED TO THE DURATION OF THIS WRITTEN WARRANTY. ANY ACTION FOR BREACH OF ANY WARRANTY HEREUNDER INCLUDING ANY IMPLIED WARRANTY OF MERCHANTABILITY MUST BE BROUGHT WITHIN A PERIOD OF 30 MONTHS FROM DATE OF ORIGINAL PURCHASE. IN NO CASE SHALL THE COMPANY BE LIABLE FOR ANY CONSEQUENTIAL OR INCIDENTAL DAMAGES FOR BREACH OF THIS OR ANY OTHER WARRANTY, EXPRESS OR IMPLIED, WHATSOEVER. No person or representative is authorized to assume for the Company any liability other than expressed herein in connection with the sale of this product.

Some states do not allow limitations on how long an implied warranty lasts or the exclusion or limitation of incidental or consequential damage so the above limitations or exclusions may not apply to you. This Warranty gives you specific legal rights and you may also have other rights which vary from state to state.

U.S.A. : AUDIOVOX ELECTRONICS CORPORATION, 150 MARCUS BLVD.
HAUPPAUGE, NEW YORK 11788 • 1-800-645-4994

CANADA : CALL 1-800-645-4994 FOR LOCATION OF WARRANTY STATION SERVING YOUR AREA

128-5556C