

Model

UPM51 PROJECTOR MOUNT

Thank you for purchasing the *PDR* Projector mount with the exclusive **“Bayonet locking system”**.
To ensure the correct usage, please read and follow the instructions manual thoroughly. Please store the instructions in a safe place for future reference.

All *PDR* mounts and adapters carry a lifetime warranty against defects in material and workmanship. We are not liable for improper installation that results in damage to mounts, adapters or presentation equipment.

Special techniques are necessary for installation of the panel display mount.

- Do not attempt to perform this work by yourself.
- Request an installation specialist to install this unit.
- Manufacturer assumes absolutely no responsibility for injuries and damages that may occur due to improper installation and handling.
- Please remember that if you remove the mount from the wall/ceiling later, you will find the screw holes and anchor bolts for the mounting unit left on the wall.

To ensure customer safety, be sure to decide the installation location so that the strength is sufficient to withstand the weight of both the projector and the mount.

Fully tighten all of the mounting screws as specified in the instructions.

Features

- Simple to adjust no-tools required
- Low profile 4.8”
- Applications for 1 ½”NPT mounting
- +- 20 deg. Pitch
- + -30 deg. yaw
- 360 deg. rotation
- Quick projector removal with exclusive **“Bayonet locking system”**

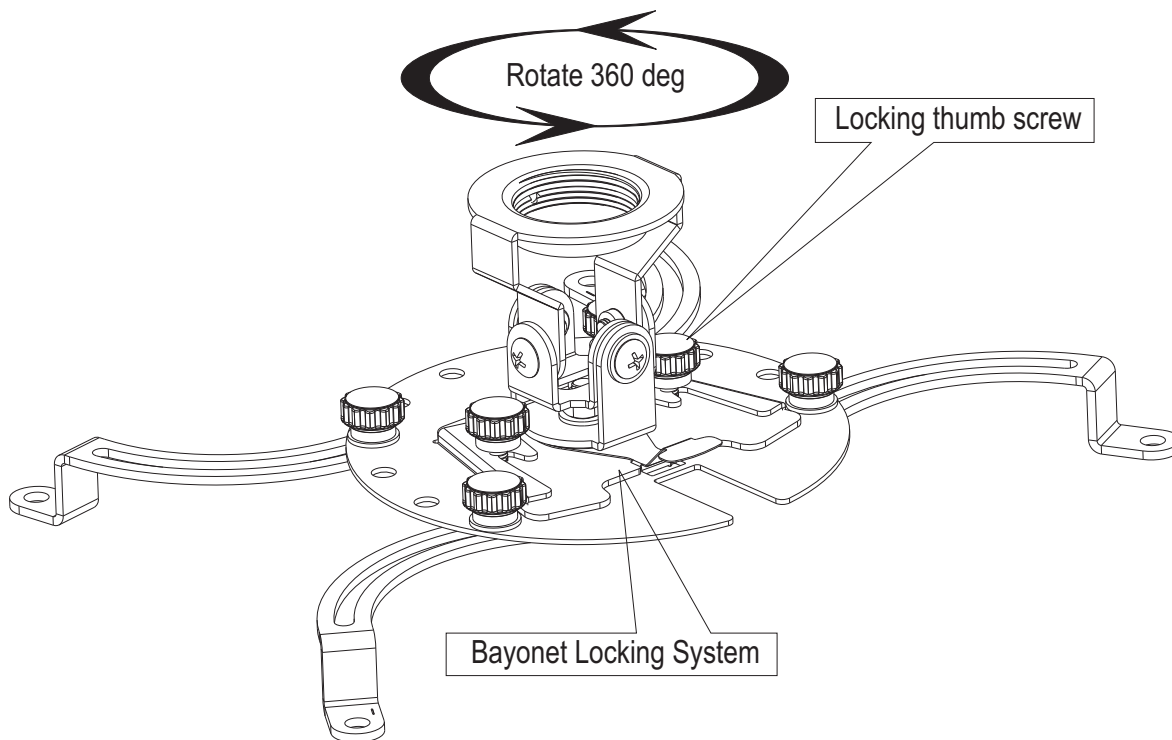

INSTALLATION LOCATION



WARNING

- ⊘ The ceiling where the mount is to be installed must be capable of long-term support of the total load of the projector and mount. Measures should be taken to ensure sufficient strength to withstand the force of earthquakes, vibrations and other external forces.

Note: Incorrect installation can cause the projector mount to fall and cause injury.

**Total load of the mount (projector + Mount)
Maximum weight - 40 Lbs (10Kg.)**



INSTALLATION ON A WOODEN WALL

Always install so that the load is supported by a wood stud. If the strength of the wood studs is not sufficient, add reinforcement. Do not install on decorative posts or plaster board. **Always confirm the center of the stud is used for the installation.**



CAUTION

- Avoid installing in locations where the temperature and humidity are excessively high, and where contact with any water is possible. These can result in fire or electric shock.
- Do not install close to an air conditioner intake or outlet. Do not install in locations where there are excessive amounts of dust, oily smoke or tobacco smoke. Fire could result.
- Do not block the ventilation holes. Leave sufficient clearance in regard to the surroundings to avoid blocking the ventilation. The internal temperature could elevate and possibly result in fire. Install the projector (4") or more away from surroundings.
- Do not install in locations where there is excessive vibration or impact. Injury and damage could result from the projector mount falling.
- Do not install where there is direct sunlight or other strong light. Strong light could result in eye fatigue during usage.



WARNING

- Use the specified bolts and screws in the specified places and tighten firmly. Failure to do this could cause injury if the projector mount falls.
- Do not alter any of the parts. Do not use broken parts. This could result with injury due to the projector mount falling.

Caution: Installation of unit is to be carried out by qualified technicians only. Install in an appropriate location by checking the wall structure and durability for safety and accident prevention.

ADAPTER PLATE HARDWARE













A		Leveling barrels 4 pcs
B		1/4-20 x 5/8 carriage bolts 4 pcs
C		9/32" x 47/64" Nylon washer 4 pcs
D		4.3 mm x 8.9mm steel washer 4pcs
E		2.7mm x 6mm steel washer 4 pcs
F		Black plastic knob 4 pcs
G		M6 x 25mm Pan Head Philips machine Screw 4 pcs
H		M4 x 25mm Pan Head Philips machine Screw 4 pcs
I		M 3 x 25mm Pan Head Philips machine Screw 4 pcs
J		M2.6 x 25mm Cheese Head slotted machine Screw 4 pcs Note: must be used with washer "E"
K		Adjustable arm (left) 2 pcs
L		Adjustable arm (right) 2 pcs
M		Adapter plate 1 pc

Fig 1



1. FASTEN THE PROJECTOR MOUNT TO 1 ½" NPT PIPE

- 1: The bracket must be secured to a ceiling structure capable of at least (4) times the weight of the projector + mount.
- 2: Screw the bayonet sub assembly onto the 1 ½" NPT (not supplied).
- 3: Secure with the locking set screw making sure the sub assembly safety lever is facing the front of the projector. **SEE FIG 2**

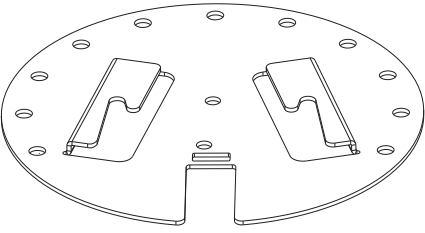
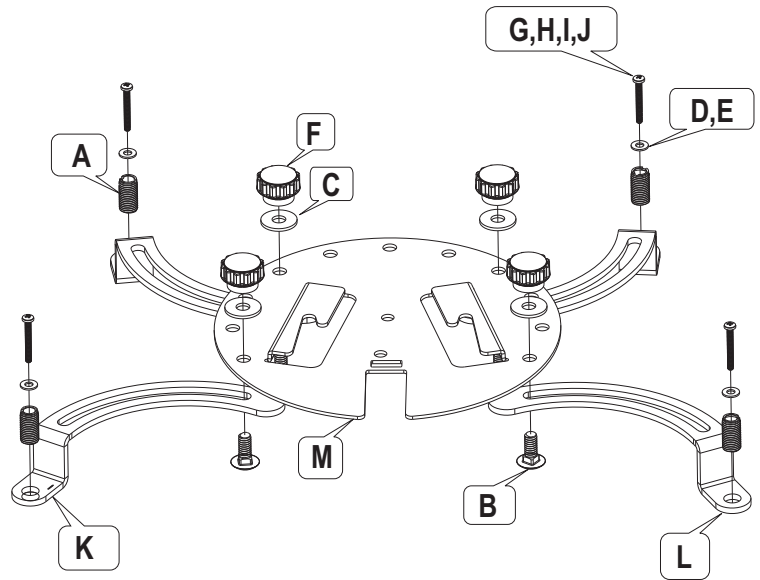
Fig 2

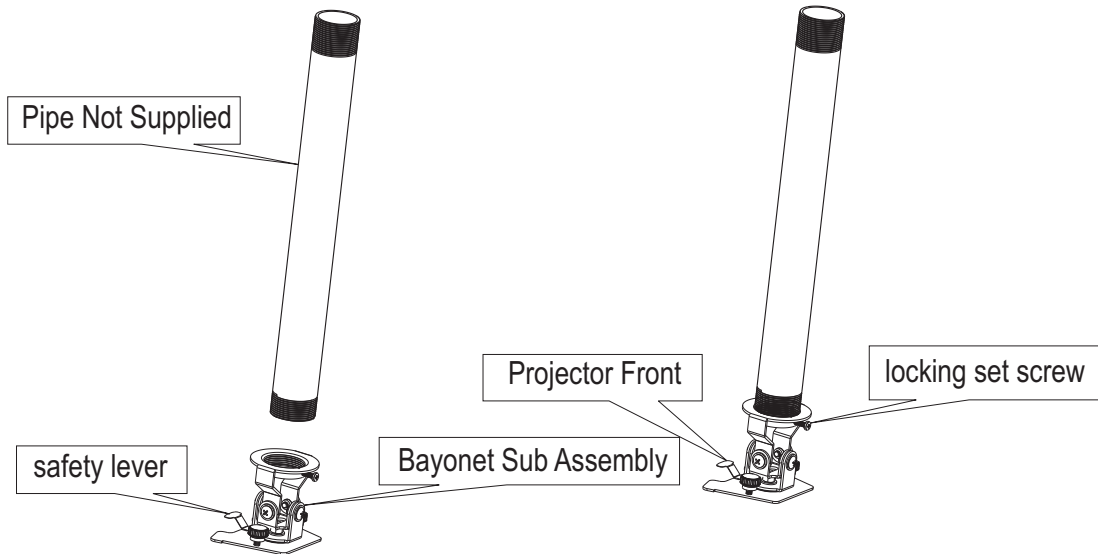

2. ATTACH THE ADAPTER PLATE TO THE PROJECTOR.

- 1: Start by screwing the leveling barrels (A) into the Adjustable arms (K and L). A screwdriver slot is provided in the barrel (A). The barrels only need to be threaded approx. 1/8" through the bottom of the arm (K and L). If the mounting plane of the projector is not flat, the barrels can be adjusted to make up the difference in height.
- 2: Using the adapter plate (M) attach the adjustable arms (K,L) with the hardware supplied (B,C,F). No need to tighten at this time.
- 3: Place the Universal adapter plate onto the projector. Using the proper hardware supplied (screws G,H,I, or J) (washers D or E) lightly fasten to the projector. **SEE FIG 3**
- 4: Position the universal adapter plate approx over the center of the projector. Tighten the screws to the projector and then tighten the plastic knobs (You can also adjust the adapter plate assembly to access the filters and light source to suite.)
Be careful to not over tighten the projector screws.

Damage to the projector may occur if the screws to the projector are over tightened.

SEE FIG 3 for details

Fig 3

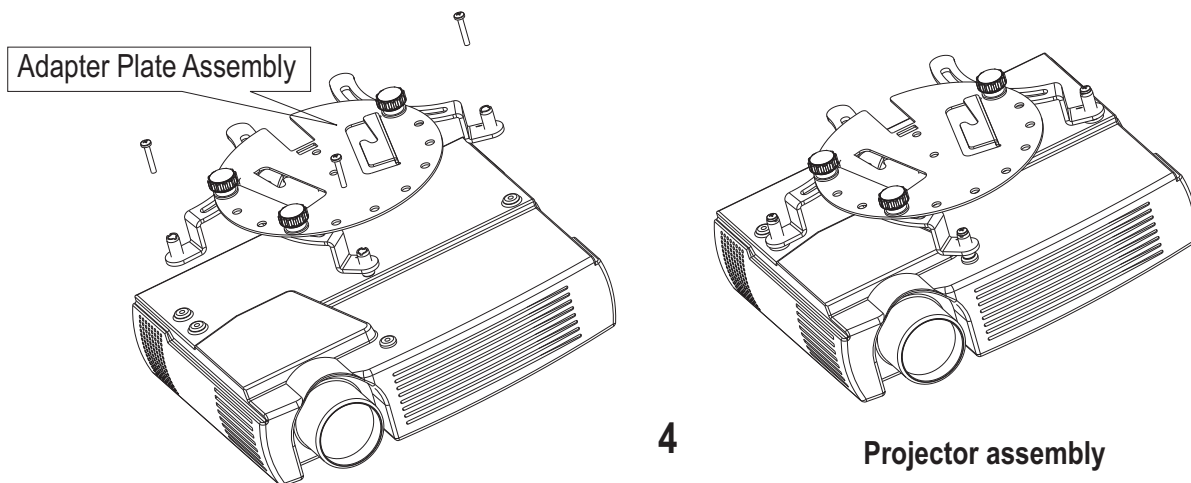

4

Projector assembly

3. MOUNT THE PROJECTOR ASSEMBLY TO THE PROJECTOR MOUNT

- 1: Place the projector assembly into the bayonet slots on the mount (**small end into large end**) and slide backward until the safety lever engages **SEE FIG 4**.
- 2: Adjust the thumb screws to secure the mount to the projector.
- 3: To remove, loosen the thumb screws and lift the safety lever to slide the unit out.
- 4: Adjust for best view and tighten all hardware.

