

*Sunbeam*

# VitaSteam Electronic

## Programmable Food Steamer

Instruction Booklet  
ST6810

Please read these instructions carefully  
and retain for future reference.



# Contents

<b>Sunbeam's Safety Precautions</b>	<b>1</b>
<b>Features of your VitaSteam Electronic</b>	<b>2</b>
<b>An introduction to Steam Cooking</b>	<b>4</b>
<b>Using your VitaSteam Electronic</b>	<b>5</b>
<b>For Best Results</b>	<b>6</b>
<b>Guide to the Instant Steam Function</b>	<b>7</b>
<b>Guide to Water Levels</b>	<b>7</b>
<b>Guide to using the Steaming Trays</b>	<b>8</b>
<b>Guide to using the Rice Bowl</b>	<b>8</b>
<b>Care and Cleaning</b>	<b>9</b>
<b>Cooking Times</b>	
<b>Vegetables</b>	<b>10</b>
<b>Rice, Grain &amp; Cereals</b>	<b>12</b>
<b>Fish &amp; Seafood</b>	<b>13</b>
<b>Poultry</b>	<b>14</b>
<b>Eggs</b>	<b>15</b>
<b>Recipes</b>	<b>16</b>

## Important instructions – retain for future use.

تأكد من تفهم احتياطات السلامة المذكورة اعلاه

請務必理解上述的安全預防措施。

Assurez-vous que les précautions ci-dessus relatives à la sécurité sont bien comprises

Versichern Sie sich, dass die obestehenden Sicherheitsmaßnahmen Verstanden werden

Βεβαιώνετε πως οι παραπάνω προφυλάξεις ασφαλείας γίνονται κατανοητές

Pastikan bahwa tindakan-tindakan keselamatan seperti di atas dimengerti anda

Accertatevi che le suddette norme di sicurezza siano comprese a dovere

上記の注意事項をよくお読みになり、安全を御確認ください

Уверете се дека погоре споменатите мерки на претпазливост се добро разбрани

Asegúrese de que las precauciones de seguridad precedentes sean bien comprendidas

کاری بکنید کہ احتیاط‌های بالا حتماً درک بشوند

ต้องแน่ใจว่า ข้อควรระวังเรื่องความปลอดภัยข้างต้น เป็นที่เข้าใจกันดี

Yukarda belirtilen güvenlik önlemlerinin anlaşıldığından emin olunuz

Xin kiểm chắc rằng những biện pháp làm an toàn kể trên được hiểu rõ

# Sunbeam's Safety Precautions

## SAFETY PRECAUTIONS FOR YOUR SUNBEAM VITASTEAM ELECTRONIC.

- Ensure your steamer is used at least 50cm (half a metre) away from a gas flame or electric element.
- Do not operate the steamer on an inclined surface.
- Do not move or cover the steamer while in operation.
- Do not immerse the base of the steamer in water or any other liquid.
- Use your steamer well away from walls, curtains and cupboards that may be affected by steam.
- Do not use your steamer in confined spaces.
- Remove the cover away from you after steaming.

---

**Sunbeam are very safety conscious when designing and manufacturing consumer products, but it is essential that the product user also exercise care when using an electrical appliance. Listed below are precautions which are essential for the safe use of an electrical appliance:**

- Read carefully and save all the instructions provided with an appliance.
- Always turn the power off at the power outlet before you insert or remove a plug. Remove by grasping the plug – do not pull on the cord.
- Turn the power off and remove the plug when the appliance is not in use and before cleaning.
- Do not use your appliance with an extension cord unless this cord has been checked and tested by a qualified technician or service person.
- Always use your appliance from a power outlet of the voltage (A.C. only) marked on the appliance.
- Close supervision is necessary when your appliance is being used near children or infirm persons.
- Never leave an appliance unattended while in use.
- Young children should be supervised to ensure that they do not play with the appliance.
- Do not use an appliance for any purpose other than its intended use.
- Do not place an appliance on or near a hot gas flame, electric element or on a heated oven. Do not place on top of any other appliance.
- Do not let the power cord of an appliance hang over the edge of a table or bench top or touch any hot surface.
- For safety reasons and to avoid maintenance by unskilled persons, some appliances are 'sealed' using tamperproof screws. Such appliances should always be returned to the nearest Sunbeam Appointed Service Centre for adjustment or repair if required.
- Do not operate any electrical appliance with a damaged cord or after the appliance has been dropped or damaged in any manner. If damage is suspected, return the appliance to the nearest Sunbeam Appointed Service Centre for examination, repair or adjustment.
- For additional protection, Sunbeam recommend the use of a residual current device (RCD) with a tripping current not exceeding 30mA in the electrical circuit supplying power to your appliances.
- Do not immerse the appliance in water or any other liquid unless recommended.

If you have any concerns regarding the performance and use of your appliance, please visit [www.sunbeam.com.au](http://www.sunbeam.com.au) or contact the Sunbeam Consumer Service Line. Ensure the above safety precautions are understood.

# Features of your VitaSteam Electronic

### 6 cup capacity rice bowl

The separate rice bowl cooks 6 cups of cooked, light and fluffy rice every time.

### 3 steaming trays

Enables you to cook your entire meal using one appliance. Steam meat and seafoods in the lower tray, then add the upper trays to steam nutritious vegetables. The steaming bowls are shatter resistant to prevent breakage. Trays can also have the bases removed to allow for larger foods.

### Neon ON/OFF light

Indicates when the appliance is steaming.

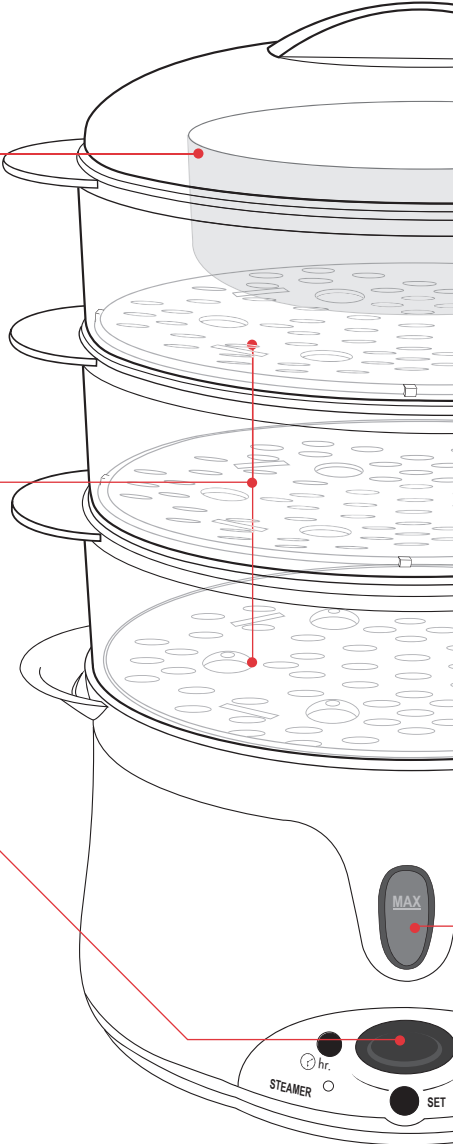

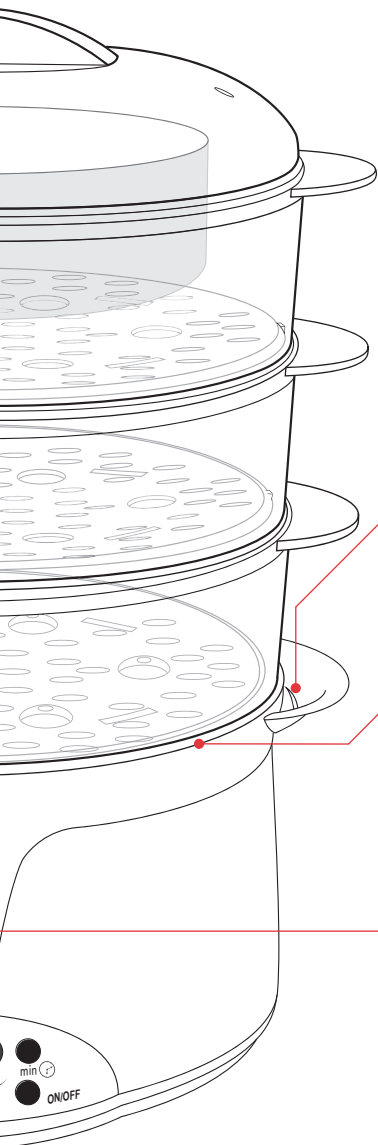

**External water fill hole**

Allows you to add water to the steamer without removing the steaming trays.

**Removable drip tray**

Collects the fats, juices and condensation during steaming, and is removable for easy cleaning.

**Water level indicator**

External water level indicator allows you to see the water levels at all times.

# An Introduction to Steam Cooking

Congratulations on the purchase of your new Sunbeam VitaSteam electronic food steamer. You will now be able to enjoy the benefits and convenience of steam cooking.

Steaming is one of the healthiest cooking methods available, as it requires no fats or oils. Steaming ensures that fruit and vegetables retain vitamins and minerals required for a balanced diet. Meats such as chicken can be gently steamed to retain their flavour and tenderness, while the fats drain away.

Steaming is also gentle, as the food never comes in contact with the cooking liquid, ensuring that it retains its shape, colour and texture.

# Using your VitaSteam Electronic

Before using your VitaSteam Electronic for the first time, wash the steaming bowls, rice bowl, lid and drip tray in warm soapy water. Rinse and dry thoroughly. Operate the steamer for 15 minutes using a solution of 1 tablespoon lemon juice and 2 cups water in the reservoir.

**Note:** You may notice a slight odour during this first operation. This is normal with many heating appliances and will not affect the performance of your steamer.

1. Fill the water reservoir above the 'MIN' water level and no higher than the 'MAX' water level.

**Note:** Use only clean water in your VitaSteam Electronic. Do not use wine, stock or other liquids.

2. Put the Removable Drip Tray in place.

**Note:** Do not operate the Steamer without the Removable Drip Tray.

3. Place food to be steamed without sauce or liquid into the steaming bowls and place on the Power Base. If steaming with sauce or liquid, use the rice bowl and place inside one of the steaming bowls.

4. Replace the lid.

5. Insert the plug into a 230-240V power outlet and turn the power on.

6. To set the Timer turn unit on by pressing the Power button.  00:00 will appear on the LCD screen.

7. Press the "SET" button once and the word "STEAMER" will appear on the LCD screen. An automatic cooking time of 10 minutes will appear. To change this time use the MIN (minutes) and HR (hours) buttons to change cooking time to the desired cooking time. There is a maximum cooking time of 3 hours 59 minutes. Once the cooking time has been chosen

the unit will turn on automatically after 5 seconds. The neon cooking light will go on to let you know that steaming has commenced. 5 beeps will sound when the selected time has elapsed and the steamer will automatically go to a "KEEP WARM" function.

**Note:** If the water in the Steamer runs out before the cooking has finished the unit will sound a continuing beep and the Neon light will blink. See section on the Automatic Boil dry sensor setting on page 6.

8. Using oven mitts or a cloth, remove the lid by tilting it away from you to ensure steam is safely released without scalding. Hold the lid over the steamer to allow the condensation to drain into the unit before removing completely. Remove the plug from the power outlet after use.

9. Remove the steamer tray/rice bowl and serve the food.

**Note:** Use caution when handling the base of the unit and steamer/rice bowl as these will be hot.

## Delay Start

You can delay your cooking process by up to 30 minutes. This helps you to get all food ready in advance and the Steamer will start itself once the desired time has been selected.

1. Turn unit on by pressing the Power . 00:00 will appear on the LCD screen

2. Press the "SET" button once and the word "STEAMER" will appear on the LCD screen. An automatic cooking time of 10 minutes will appear. To change this time use the MIN (minutes) and HR (hours) buttons to change cooking time to the desired cooking time. There is a maximum cooking time of 3 hours 59 minutes.

3. Press the “SET” button again, and the word “TIMER” will appear on the LCD. Press the MIN (minutes) button to the desired delay time. There is a maximum of 30 minutes that this function can be used for. Once the delay time has been chosen the unit will turn on automatically after 5 seconds and the delay countdown will begin. Once the delay time has finished the Steamer will start the cooking process.

### **Keep warm function**

The steamer is fitted with a “Keep Warm” function. Once the selected cooking time has finished the Steamer will beep 5 times. The unit will automatically go to the “Keep Warm” function where the Steamer will switch itself on and off releasing a small amount of steam at a time to keep your food warm. The Steamer will stay in the “Keep Warm” setting function for 1 hour. After 1 hour the Steamer will beep 3 times and the Steamer will turn off.

### **Automatic boil dry sensor setting:**

The Steamer is fitted with an automatic boil dry sensor which switches off the heating element if the base is accidentally switched on empty or boils dry. If this occurs a continuing beep will sound and the Neon light will blink. If cooking, the timer will stop. Refill water through the spout and press the “SET” button to recommence the cooking process. The timer will continue with the remaining cooking time left on the LCD.

---

## For Best Results

The cooking times stated in this booklet are a guide only. The steaming time required for specific foods is affected by the following:

- The size, quality and the temperature of the food.
- The degree to which you like your food cooked.
- The temperature of the water used for steaming.

To ensure good results using your VitaSteam Electronic, follow these simple tips: –

- Remove food soon after the steaming cycle is completed. Food will continue to cook slightly with the keep warm function.
- Food should be arranged evenly in all steamer bowls. Foods of uniform size will steam at a similar rate.



# Guide to Instant Steam Function

The VitaSteam Deluxe features an Instant Steam Function that will enable steam to be generated in as little as 30 seconds. For this feature to operate you must place the Removable Drip Tray with instant steam sleeve in position.

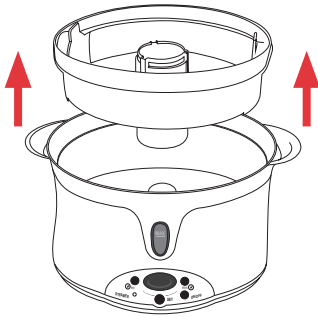

The Sleeve concentrates a small amount of water around the Exposed Heating Element, quickly bringing it to boiling temperature to produce steam, rather than heating all of the water in the reservoir.

The Sleeve has a small cut out in the bottom to allow water to flow into the contained water area.

For more efficient steaming we recommend that the appliance is always operated with the Removable Drip Tray with instant steam sleeve in position.

---

# Guide to Water Levels

Your VitaSteam Electronic relies on the water reservoir being full of water to operate. Fill the water reservoir with clean water only. The water level must be between the 'MIN' (500ml) and 'MAX' (1000ml) markings.

When continuously cooking food with your steamer ensure that the water level does not fall below the 'MIN' marking (500ml).

If this does occur your VitaSteam Electronic is fitted with an Automatic boil dry sensor. See previous page for more details.

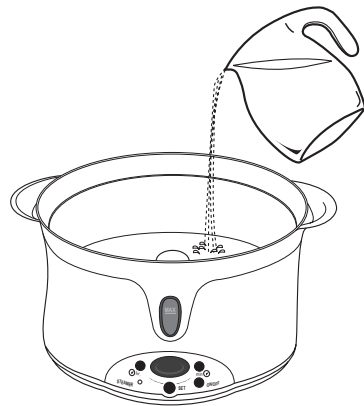

# Guide to using the Steaming Trays

The VitaSteam Electronic comes with three steaming trays. The appliance can operate with all trays stacked on top of each other or with just one tray in position. See Figure 1.

Trays can also have the bases removed to allow for larger foods. See Figure 2.

Place the largest piece of food with the longest cooking time in the lower steaming bowl, then place on top of the Removable Drip Tray and Power Base.

Then place the upper steaming tray on top for cooking of vegetables.

**Note:** Ensure bases are properly clicked into the sides of each tray before use.



Figure 1



Figure 2

---

# Guide to using the Rice Bowl

Cooking of rice must be done in the Rice Bowl. The Rice Bowl must be placed in the top steaming tray with the lid.

Both uncooked rice and water must be added to the Rice Bowl. Check the recommended quantities on Page 12. For perfect rice, ensure you rinse rice properly with cold running water before cooking.

When handling the Rice Bowl use insulated pot holders/oven mitts to avoid burns from the hot steam.

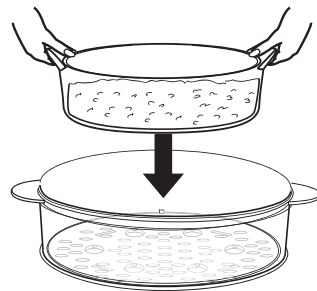

# Care and Cleaning

Before cleaning your Sunbeam VitaSteam Electronic, ensure the power is turned off at the power outlet and the plug removed.

Wash the rice bowl, steam tray, drip trays and the lid in warm, soapy water, rinse and dry.

**DO NOT** wash in dishwasher as the hot water temperatures and harsh detergents may ultimately warp and scratch these parts. **DO NOT** use abrasives or abrasive cleaners as these may also cause scratching.

Wipe out the interior of the steamer base with a warm, damp cloth or a small brush. Wipe the exterior of the base with a damp cloth or sponge. **DO NOT** use abrasives or abrasive cleaners as these may scratch the steamer base.

## **Warning.**

NEVER IMMERSE THE BASE OF YOUR STEAMER IN WATER OR ANY OTHER LIQUID.

## **Important – Mineral Deposits.**

Mineral deposits may accumulate on the Exposed Heating Element which can result in your Sunbeam VitaSteam Electronic switching off before the cooking cycle is complete. To remove this build up use a wet scouring pad and rub over the surface of the heating element only after each use.

Alternatively, prepare a solution of either:  
(i)-2 cups of water in which 1 teaspoon of cream of tartar has been dissolved; or

(ii)-2 cups of water to which 1 tablespoon of lemon juice or white vinegar has been added.

Pour the solution into the reservoir, position the Lid and operate your Sunbeam VitaSteam Electronic for approximately 15 minutes. Remove the lid and clean as directed. If excess scale has built up, repeat this process.

## **Note:**

If food with a strong odour, such as fish and cabbage has been steamed, the above procedure may be followed with the Steamer trays or rice cooker bowl in position. This will ensure that the odour is not transferred to the next steaming cycle.

# Vegetables – guide to steaming times

The following are some handy hints on how to steam vegetables:

1. Before steaming, wash the vegetables thoroughly.
2. Cut off stems and peel if desired.
3. Cut vegetable to the desired size (smaller pieces steam faster than larger ones).
4. To retain the vegetables flavour and nutrients, steam until just tender, but still slightly firm.
5. When steaming several different vegetables at once, place the largest and firmest in the steamer first. Add other vegetables according to size during the steaming time.
6. If a sauce or liquid is to be prepared with the vegetables, use the rice bowl for steaming.
7. Frozen vegetables should not be thawed before steaming.

VEGETABLE	QUANTITY	APPROX. TIME IN MINUTES
Artichokes – globe	3 whole, tops trimmed	18 – 25
Asparagus	500g	12 – 15
Beans – Green or Wax	500g, cut or whole	12 – 15
Beetroot	500g, whole with 3cm tops	38 – 42
Broccoli	500g	12 – 16
Brussel Sprouts	500g	17 – 20
Cabbage	500g, coarsley shredded	12 – 16
Carrots	500g, sliced	17 – 20
Cauliflower florets	500g	17 – 20
Celery	1 bunch, thinly sliced	17 – 20
Corn on Cob	3 to 5 cobs	38 – 42
Mushrooms	500g, whole	7 – 10
Onions	250g, thinly sliced	12 – 16
Parsnip	500g, peeled and sliced	12 – 16
Peas	500g, shelled	17 – 20
Peppers	500g, halved, seeds removed	7 – 10

## Vegetables – guide to steaming times (continued)

<b>VEGETABLE</b>	<b>QUANTITY</b>	<b>APPROX. TIME IN MINUTES</b>
<b>Potatoes</b>		
1.-New	500g, whole (approx. 8)	28 – 31
2.-Red or White	500g, whole (approx. 3)	38 – 42
3.-Sweet	500g, cut into 3cm pieces	26 – 29
Pumpkin	500g, cut into 3cm pieces	26 – 29
Turnip	500g, cut into 3cm pieces	26 – 29
Zucchini	500g, sliced	7 – 10
<b>FROZEN VEGETABLES</b>		
Green Beans	500g	17 – 20
Lima Beans	500g	17 – 20
Broad Beans	500g	17 – 20
Broccoli (cuts)	500g, cuts	17 – 20
Brussel Sprouts	500g	17 – 20
Carrots (sliced)	500g, sliced	17 – 20
Cauliflower	500g	17 – 20
Mixed Vegetables	500g	17 – 20
Peas	500g	17 – 20
Corn on Cob	500g	26 – 29

# Rice, Grain & Cereals – guide to cooking times

To cook rice in the rice cooker bowl, the following are some handy hints:

1. Wash rice well under cold running water, using a fine sieve.
2. Place rice and water into the rice cooker bowl.
3. Cover with the lid and set the timer.
4. For firmer rice, slightly decrease the water specified in the rice cooker bowl.
5. For softer rice, slightly increase water quantity.

## RICE, GRAIN AND CEREALS

VARIETY	RICE COOKER BOWL		APPROX. TIME IN MINUTES
	Cups of Rice	Cups of Water	
Long Grain	1	1	22 – 29
Long Grain	2	2	30 – 36
Brown – Regular	1	1½	58 – 62

## OTHER GRAINS AND CEREALS

VARIETY	METHOD	APPROX. TIME IN MINUTES
Oatmeal Regular	Put ½ cup oatmeal and 1 cup water into Rice Cooker bowl.	17 – 20
Rolled Oats	Put 1 cup rolled oats and 1½ cups water in Rice Cooker bowl. Place in the steaming tray, then put the lid on and set the timer.	17 – 20
Wheat-Cracked	Put 1 cup of cracked wheat into Rice Cooker bowl with 1½ cups of water. Place in the steaming tray, then put the lid on and set the timer.	26 – 29

# Fish and Seafood – guide to cooking times

The following are some handy hints on steaming your fish and seafood:

1. Place fish in the Steamer tray.
2. If fish or seafood is to be poached or cooked in a sauce, use the Rice Cooker bowl.
3. Add lemon wedges, herbs and seasoning before steaming, as desired.
4. Add butter or margarine after steaming, if desired.
5. Fish is cooked when it flakes easily with a fork and is opaque in colour.
6. Frozen fish may be steamed without defrosting, except for fillets which need to be defrosted and separated before steaming. Fillets are best steamed in a single layer.
7. When steaming frozen fish, extend the steaming time.

TYPE	QUANTITY	APPROX. TIME IN MINUTES	SUGGESTIONS
Clams	500g	7 – 20	Steam just until open.
Lobster, whole	750g	17 – 20	Steam just until red.
<b>Fish</b>			
1)-Fillet	500g	12 – 16	Cook until fish flakes easily
2)-Steak	2cm thick	17 – 20	with fork. Season fish as desired
3)-Whole	500 – 750g	17 – 20	with lemon juice, wine or herbs.
Mussels	500g fresh in the shell	12 – 16	Steam just until open.
<b>Prawns</b>			
Medium	500g, in the shell	12 – 16	Steam just until pink.
Large	500g, in the shell	12 – 16	Steam just until pink.
Scallops, shelled	500g	12 – 16	Steam just until hot and tender.

# Poultry – guide to cooking times

To steam chicken and poultry using your VitaSteam Deluxe, the following are some handy hints:

1. Select pieces of poultry of similar size for even cooking.
2. Arrange poultry in a single layer, to facilitate even cooking.
3. Removal of fat and the removal of skin is recommended.
4. If some colour is desired, brown poultry well in a non-stick frypan before steaming.
5. Steam until well done. Check by piercing the thickest part of the poultry. If the juices run clear, it is cooked.

<b>TYPE</b>	<b>QUANTITY</b>	<b>APPROX. TIME IN MINUTES</b>	<b>SUGGESTIONS</b>
Breast, on Bone	250g (2 pieces)	38 – 41	Flesh side down.
Drumstick	500g (4 pieces)	33 – 36	Thickest part to outside of Steamer tray.
Thighs, on Bone	500g (4 pieces)	33 – 36	Thickest part to outside of Steamer tray.
Poached Breast Boneless	500g (2 pieces)	42 – 45	Poach in Rice Cooker bowl.
Chicken, whole	1.3kg	50	
Duck, pieces	500g (4-6 pieces)	47 – 50	Remove all visible fat
Quail, whole	500g (6 pieces)	22 – 25	
Whole breast fillet	200g 38-45 (1 side of breast)		



# Eggs – guide to cooking times

The following are some handy hints for cooking eggs in the VitaSteam Electronic:

1. The Steamer is ideal for boiling, poaching or scrambling eggs.
2. Using the Steamer tray, eggs may be cooked in the shell or cracked into individual size heatproof dishes.
3. Scrambled eggs may be prepared in the rice cooker bowl.
4. Large eggs will require slightly longer cooking times.

---

VARIETY	QUANTITY	APPROX. TIME IN MINUTES
Soft Boiled	1 – 8	7 – 9
Hard Boiled	1 – 8	12 – 19
<b>POACHED</b>	1 – 6	12 – 15
Crack eggs into well greased ramekin dishes or smallcups and place into Steamer. Cover and steam.		
<b>SCRAMBLED</b>	6	17 – 20
Beat together eggs and $\frac{1}{4}$ cup milk in rice cooker bowl. Season with salt and pepper. Stir eggs 2-3 times during cooking.		

---

## Guide to recipes

The recipes in this book are a guide to the various types of food you can cook in your Sunbeam VitaSteam Electronic.

Each recipe specifies if the Steamer tray or the rice cooker bowl should be used.

Under each recipe title there is a note of the approximate cooking time required. This may not always produce food cooked to your personal taste (over cooked/under cooked).

However, after you have used your Sunbeam VitaSteam Electronic and experimented with it, you will be able to decide the exact time requirements to achieve results you wish.

# Recipes

## **Prawn dumplings**

**Makes 24**

*Approximate cooking time 12-15 minutes*

- 1kg uncooked prawns
- 2 tablespoons finely chopped bamboo shoots
- 2 tablespoons finely diced carrot
- 1 tablespoon finely chopped chives
- 3 teaspoons sesame oil
- 2 teaspoons cornflour
- sea salt
- 24 gow gee wrappers

1. Shell and devein prawns. Process prawns until just smooth. Combine prawns in large bowl with bamboo shoots, carrot, chives, oil, cornflour and salt.
2. Place one wrapper on your hand; place one heaped teaspoon of the prawn mixture into centre of wrapper. Gently cup your hand and gather sides of wrapper to form pleats, leaving top open. Press base of wrapper on bench to flatten. Repeat with remaining wrappers and prawn mixture.

Arrange dumplings in the Steamer Baskets. Place the lid on and set the timer.

## **Chicken Gow Gee**

**Makes 24**

*Approximate steaming time 12-15 minutes*

- ¼ cup sliced dried shitake mushrooms
- 1 tablespoon finely chopped, unsalted, roasted peanuts
- 1 clove garlic, crushed
- 1 green onion, chopped finely
- 1 long red chilli, seeded, chopped finely
- 2 teaspoons hoisin sauce
- 200g chicken mince
- 24 gow gee wrappers

1. Place mushrooms in small heatproof bowl and cover with boiling water. Stand 20 minutes, drain. Chop finely.
2. Combine mushrooms in medium bowl with nuts, garlic, onion, chilli, sauce and chicken.
3. Place one heaped teaspoon of mixture in centre of one wrapper; brush around half of the wrapper's edge with a little water. Pleat damp side of wrapper only; pinch both sides together to seal. Repeat with remaining chicken mixture and wrappers.
4. Arrange gow gee in Steamer Baskets. Place lid on and set timer.

## Recipes (continued)

### **Asparagus with Lemon & Butter**

*Approximate steaming time 12-16 minutes.*

500g fresh asparagus  
40g butter, melted (or 2 teaspoons olive oil)  
2 tablespoons lemon juice  
2 teaspoons finely chopped parsley  
cracked black pepper

1. Arrange asparagus evenly in Steamer tray.
2. Place the lid on and set the timer.
3. Place asparagus onto serving platter, pour over melted butter, lemon juice, parsley and pepper. Serve at once.

### **Minted Tabouli Salad**

*Approximate steaming time 17-20 minutes.*

¼ cup cracked wheat  
2 cups parsley sprigs  
4 green onions, chopped  
¼ cup mint leaves, finely chopped  
250g punnet cherry tomatoes, halved  
juice of 3 lemons  
1 tablespoon olive oil

1. Place cracked wheat and ½ cup of water into the Rice cooker bowl. Position the Rice cooker bowl, place the lid on and set the timer.
2. Cool cracked wheat. Add remaining ingredients and combine well.

### **Saffron Rice**

*Approximate steaming time 30 minutes.*

1 cup uncooked white rice  
2-3 threads of saffron, or pinch saffron powder  
1 small onion, chopped finely

1. Place rice into the rice cooker bowl, combine saffron with 1 cup of water. Pour over rice and add the onion.
2. Position the rice cooker bowl, place the lid on and set the timer. Serve warm.

## Recipes (continued)

### **Wild Rice Salad**

*Approximate steaming time 30 minutes.*

- 1 cup uncooked wild rice
- 2 tomatoes, diced
- 6 green onions, sliced
- 1 stick celery, diced
- 1 teaspoon chopped mint
- 2 tablespoons white vinegar
- 2 tablespoons olive oil
- salt & pepper to season

1. Place rice and 1½ cups of water into the rice cooker bowl. Position the Rice cooker bowl, place the lid on and set the timer.
2. Toss with tomato, green onions, celery and mint. Chill.
3. Combine vinegar, oil and seasonings. Toss with rice just before serving.

### **Tortellini with Tomato and Basil Sauce**

*Approximate steaming time 20 minutes.*

- 500g fresh tortellini
- 750ml bottled tomato sauce
- 100ml chicken stock
- 2 tablespoons red wine
- ⅓ cup fresh basil, chopped
- 2 tablespoons grated fresh parmesan cheese
- basil fresh for garnish

- 1.-Place tortellini into the rice cooker bowl.
- 2.-On stove top, bring tomato sauce, chicken stock and wine to the boil, pour over tortellini.
- 3.-Position the rice cooker bowl, place the lid on and set the timer.
- 4.-Toss through basil and parmesan cheese. Garnish with basil.

### **Asian Style Steamed Marinated Pork Ribs**

*Approximate cooking time 25-30 minutes*

- ½ cup shao hsing wine (Chinese rice wine) or dry sherry
- 1 tablespoon caster sugar
- 1 tablespoon grated fresh ginger
- 2 cloves garlic, crushed
- 1 tablespoon light soy
- 1 tablespoon oyster sauce
- 2 green onions, finely sliced
- 1 long red chilli, seeded, finely sliced
- 1 teaspoon sesame oil
- 500g baby pork ribs

1. Combine shao hsing wine, sugar, ginger, garlic, soy, oyster sauce, onions, chilli and sesame oil in a jug.
2. Place ribs into ceramic dish. Pour over marinade. Cover and refrigerate for at least 30 minutes.
3. Remove ribs from marinade and place into Steamer Basket. Cover with lid and set timer.
4. Serve with rice and Asian style green vegetables

## Recipes (continued)

### **Satay Prawns**

*Approximate steaming time 20-25 minutes.*

- 1kg green king prawns, shelled and deveined
- ¼ cup crunchy peanut butter
- 1 tablespoon soy sauce
- juice of 1 lemon
- 1 tablespoon plum sauce
- ½ teaspoon chilli powder

1. Arrange prawns in the rice cooker bowl. Combine remaining ingredients and spread over prawns.
2. Position the rice cooker bowl, place the lid on and set the timer.
3. After 12 minutes of steaming, stir prawns through the peanut mixture to combine. Cover and continue steaming.
4. Stir prawns again after steaming has completed. Serve with rice.

### **Bream with Pinenut Stuffing**

*Approximate steaming time 17-20 minutes.*

- 1 whole bream, gutted and scaled
- 1 rasher bacon, rind removed and finely chopped
- 2 green onions, finely sliced
- ⅔ cup white wine
- ½ cup breadcrumbs
- 2 tablespoon sour cream
- juice of ½ lemon
- fresh ground black pepper to taste

1. In a small saucepan lightly sauté bacon and green onions. Add wine and simmer until nearly all the liquid has evaporated. Remove from heat.
2. Add breadcrumbs, pinenuts and sour cream. Stir to combine.
3. Place filling into fish cavity.
4. Place fish onto piece of greased foil and pour lemon juice and black pepper over fish. Cover with foil.
5. Place fish into Steamer Basket. Place the lid on and set the timer. Steam until the fish flakes easily with a fork.

## Recipes (continued)

### **Herb Salmon Cutlets**

*Approximate cooking time 28-30 minutes.*

2 salmon cutlets  
2 onions, thinly sliced  
rind and juice of 1 lemon  
2 tablespoons chopped parsley  
1 tablespoon chopped dill  
black pepper

1. Lie cutlets in Steamer Basket. Arrange onion over cutlets. Sprinkle with lemon rind, juice, herbs and black pepper.
2. Position the Rice cooker bowl, place the lid on and set the timer.

### **Spicy Whole Chicken**

*Approximate steaming time 50 minutes.*

1 x 1.3kg chicken  
2 lemons, rind and juice removed  
3 cloves garlic  
2 teaspoons brown sugar  
1½ teaspoons ground cumin  
1 teaspoon tumeric  
½ teaspoon cayenne pepper

1. Remove giblets, wash and pat dry chicken.
2. Place lemon rind and garlic, cloves inside the chicken. Position the chicken breast up in the Rice Cooker bowl.
3. Combine lemon juice, brown sugar, tumeric, cumin and cayenne pepper. Brush mixture over the chicken using a pastry brush.
4. Position the Rice cooker bowl, place the lid on and set the timer.

### **Saucy Drumsticks**

**Serves 2**

*Approximate steaming time 20-25 minutes*

¼ cup tomato sauce  
2 tablespoons barbecue sauce  
1 tablespoon Worcestershire sauce  
1 tablespoon brown sugar  
1 teaspoon Dijonnaise  
4 chicken drumsticks

1. Combine tomato sauce, barbecue sauce, Worcestershire sauce, brown sugar and Dijonnaise in a jug.
2. Place drumsticks in a ceramic dish and cover with marinade. Cover and refrigerate for at least 30 minutes.
3. Arrange drumsticks in Steamer Basket, thickest part to outside of Steamer tray. Cover with lid and set timer.

## Recipes (continued)

### **Ginger Beef**

*Approximate steaming time 20-30 minutes.*

- 2 pieces of rump steak, trimmed of fat
  - 3 tablespoons marmalade
  - 3 teaspoons grated fresh ginger
  - 2 cloves garlic, crushed
  - 1 teaspoon fresh ginger
  - 1 tablespoon wine vinegar
1. Mix together marmalade, ginger, garlic, ground ginger and wine vinegar. Spread over sides of the beef. Cover and refrigerate for 3 hours or overnight.
  2. Arrange steaks in the Steamer tray. Place the lid on and set the timer.

### **Honey & Mustard Lamb**

*Approximate steaming time 10-15 minutes.*

- 4 lamb steaks, trimmed of fat
  - 2 tablespoons sesame seeds
  - 2 tablespoons mild mustard
  - 1 tablespoon honey
  - 2 tablespoons soy sauce
1. Mix together sesame seeds, mustard, honey and soy sauce. Spread over both sides of the lamb. Cover and refrigerate for 3 hours or overnight.
  2. Arrange lamb in Steamer tray. Place the lid on and set the timer.

### **Moroccan Chicken Breast with Couscous**

**Serves 4**

*Approximate steaming time 13-15 minutes*

- 1 tablespoon olive oil
  - 1 tablespoon finely grated lemon rind
  - 2 tablespoons lemon juice
  - 2 teaspoons ground coriander
  - 2 teaspoons ground cumin
  - 1 teaspoon paprika
  - 1 teaspoon turmeric
  - ½ cup roughly chopped flat leaf parsley leaves
  - 500g corn fed chicken breast fillets
  - 1 cup couscous
  - 1 cup water
1. Combine olive oil, lemon rind, lemon juice, coriander, cumin, paprika, turmeric and parsley in a bowl until mixture forms a paste. Season.
  2. Spread paste onto chicken. Arrange chicken breasts in Steamer Basket.
  3. Put couscous and water into Rice Cooker bowl. Position rice cooker bowl in a Steamer Basket over basket containing chicken. Cover with lid and set timer.

## Recipes (continued)

### Steamed Christmas Pudding

Serves 4

*Approximate steaming time 3 ½ hours.*

500g mixed dried fruit

½ cup brown sugar, firmly packed

90g butter or margarine

1/3 cup sherry or brandy

½ teaspoon bi-carbonate of soda

2 eggs, lightly beaten

1 cup self raising flour

½ teaspoon mixed spice

1. In a saucepan, combine mixed fruit, brown sugar, butter, water and sherry. Heat until butter is melted and mixture begins to boil.
2. Remove from heat, add bi-carbonate of soda and allow to cool completely.
3. Grease a 6 cup capacity pudding bowl.
4. Add eggs to the cooled mixture and mix until well combined. Fold through flour and spices.
5. Pour mixture into the prepared bowl, cover with a double layer of foil and tie firmly with string to form a good seal.
6. Place into steamer. Place the lid on and set timer.

**Note:** the water levels will need to be refilled during the cooking time of this recipe.

7. Re-heat pudding by heating pudding in steamer for 1 hour prior to serving. Serve with brandy custard.

### Baileys chocolate Soufflé

Serves 6

*Approximate steaming time 25 minutes.*

125g dark chocolate

¼ cup caster sugar

4 eggs, separated plus 1 extra egg white

1 tablespoon Baileys Irish cream

1. Lightly grease rice cooker bowl.
2. Melt chocolate gently in a heat proof bowl over a pan of simmering water. Once the chocolate has melted, remove from heat and stir through the sugar until dissolved. Lightly beat the egg yolks and Baileys. Stir through the chocolate mixture.
3. In a large bowl, beat the egg whites using an electric mixer until stiff peaks form. Stir through one third of the egg whites into the chocolate mixture then fold through the remaining egg whites.
4. Pour the chocolate mixture into the prepared rice cooker bowl. Cover the rice cooker bowl with a piece of greased baking paper.
5. Place rice cooker bowl into steaming tray. Replace the lid and set the timer.
6. Serve immediately with cream or ice cream and drizzled with extra Baileys.



# Notes

# Notes

# 12 Month Replacement Guarantee

We are so confident of the quality of our product, should this appliance develop any malfunction within 12 months of purchase (3 Months commercial use) due to faulty materials or manufacture, we will replace it for you absolutely free.

Should you experience any difficulties with your appliance, please phone our free call customer service line for advice on 1800 025 059 in Australia, or 0800 786 232 in New Zealand.

Alternatively, simply return the faulty appliance to your place of purchase, along with your purchase receipt.

Your Sunbeam 12 Month Replacement Guarantee naturally does not cover misuse or negligent handling, and excludes breakables such as glass or ceramic items, and normal wear and tear.

Similarly, your 12 Month Replacement Guarantee does not cover damage to household surfaces as a result of water or other substances leaking from your appliance, nor does it cover freight costs.

In Australia, this guarantee is additional to the conditions and guarantees which are mandatory as implied under the Trade Practices Act 1974 and State and Territory legislation.

## **Sunbeam Service Centres**

Sunbeam has established a network of authorised service centres throughout Australia and New Zealand to provide quick, convenient service for our customers.

Should your appliance require repair or service, either during or after the guarantee period, contact your nearest service centre.

For a complete list of Sunbeam's authorised service centres:

### **Australia**

[www.sunbeam.com.au/service-centres](http://www.sunbeam.com.au/service-centres)  
1800 025 059

### **New Zealand**

[www.sunbeam.co.nz/service-centres](http://www.sunbeam.co.nz/service-centres)  
0800 786 232

*Sunbeam*

## Consumer Hotline

In Australia

Visit [www.sunbeam.com.au](http://www.sunbeam.com.au)

Or call 1800 025 059

In New Zealand

Visit [www.sunbeam.co.nz](http://www.sunbeam.co.nz)

Or call 0800 786 232

*Sunbeam*

Is a registered Trademark of Sunbeam.

Made in China. Designed and engineered in Australia.  
Due to minor changes in design or otherwise,  
the product may differ from the one shown in this leaflet.

© Copyright. Sunbeam Corporation Limited 2006.

ABN 45 000 006 771

Sunbeam Corporation is a division of GUD Holdings Ltd.