

## SHINDAIWA OWNER'S/OPERATOR'S MANUAL

# SP210 SPRAYER



### WARNING!

Minimize the risk of injury to yourself and others! Read this manual and familiarize yourself with the contents. Always wear eye protection, gloves and a respirator when operating this unit.

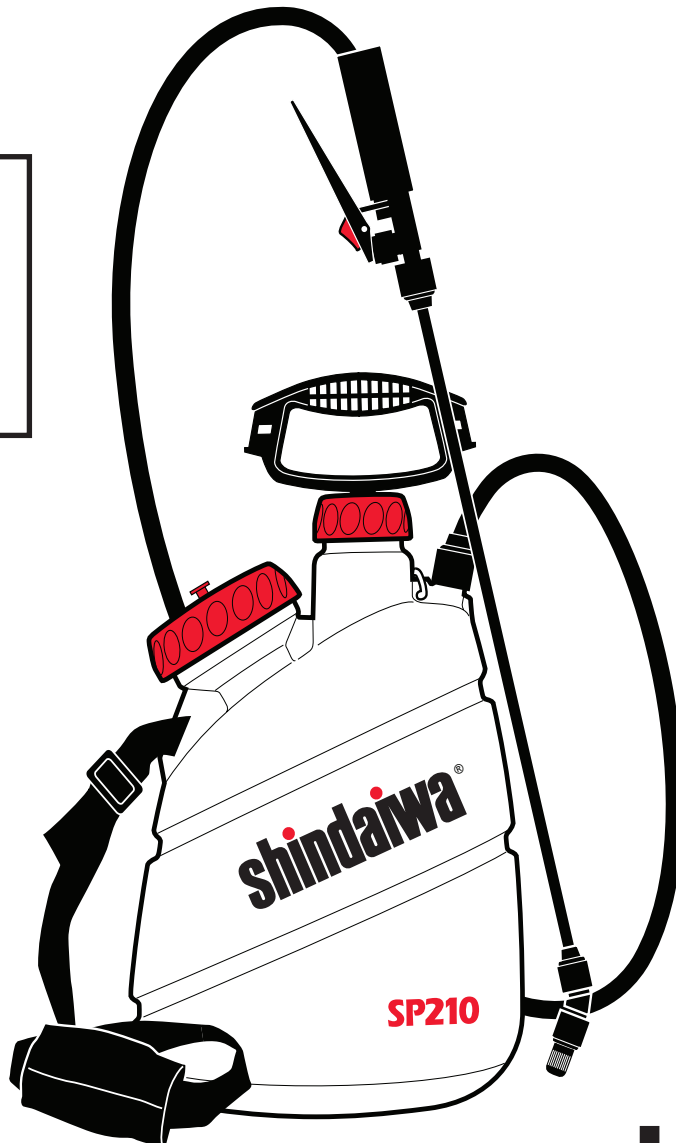

Part Number 80555 Rev. 7/06

# shindaiwa

## Introduction

This manual contains information for the proper assembly, operation and care of your SP210 sprayer. Carefully read and follow the instructions contained in this manual before operating your sprayer.

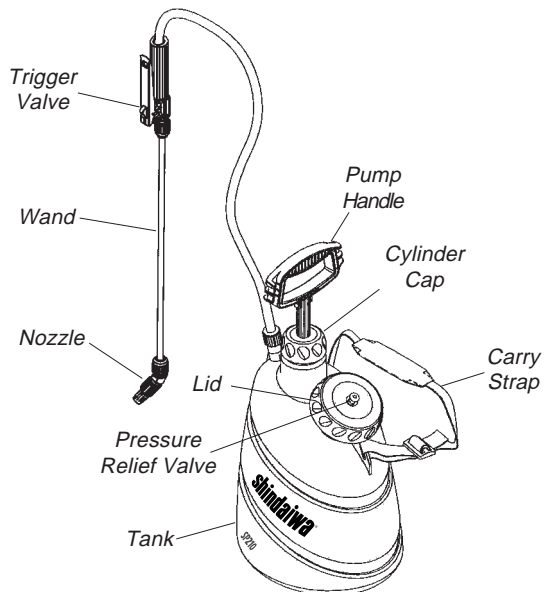

## Specifications

Net Weight .....	4.8 pounds (2.2 kg)
Tank Capacity .....	2.0 U.S. gallons (7.6 liters)
Tank Material .....	UV Protected Polyethylene
Fill Opening Diameter .....	3.6 inches (92 mm)
Pump Type/Material .....	Piston/Polyethylene
Operating Pressure .....	10-45 psi (0.7-3.15 kg/sq.cm)
Wand Assembly Length .....	27.5 inches (698.5 mm)
Hose Length .....	69 <sup>3/4</sup> inches (1771 mm)
Nozzle Installed .....	Red Adjustable Cone

Specifications subject to change without notice.

## Prepare to Assemble

Unpack the following items shipped in your sprayer box:

- Wand
- Tank Assembly
- Owner's/Operator's Manual

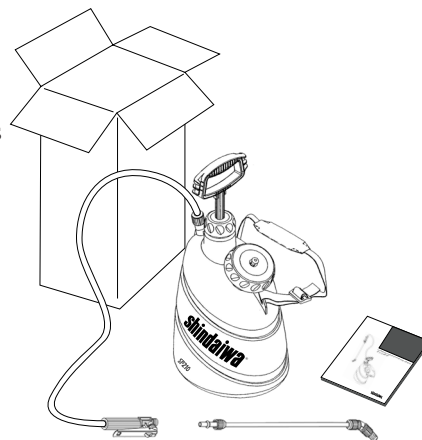

## Assembling the Spray Wand

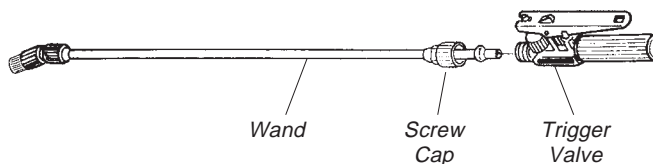

Push the wand into the trigger valve and secure with screw cap. Hand tighten to prevent leakage.

**CAUTION!**  
Do not overtighten!

### IMPORTANT!

After assembling the sprayer, fill the tank with clear water, and lay it on its side. Check for leaks. Return sprayer to its upright position. Pump the sprayer 10-40 times or until the pressure relief valve is released and check for leaks. Most leaks can be stopped by tightening the appropriate connection or fitting. Any leaks must be stopped prior to filling the sprayer with chemicals.

 **WARNING!**  
Always relieve pressure from the sprayer tank by pulling the pressure relief valve before removing the tank lid.

## Safety Precautions



Carefully read the labels on chemical containers prior to use. Chemicals are classified in four categories of toxicity:

- Category I, High Toxicity, Red label
- Category II, Moderate Toxicity, Yellow label
- Category III, Low Toxicity, Blue label
- Category IV, Light Toxicity, Green label

There are unique handling recommendations for each category, and you should familiarize yourself with them.



Always wear clothing and safety equipment that will provide appropriate protection against the materials you are handling. Equipment may include, but not be limited to:

- Long sleeve shirt
- Impermeable apron or coverall
- Impermeable gloves and boots
- Wide-brim hat
- Protective mask equipped with appropriate filters



Do not eat, drink, or smoke while handling chemicals or while you are spraying. Always handle chemicals in a well ventilated area while wearing appropriate protective clothing and safety equipment. **DO NOT STORE OR TRANSPORT CHEMICALS WITH FOOD OR MEDICINES, AND NEVER REUSE A CHEMICAL CONTAINER FOR ANY OTHER PURPOSE.**



Keep chemicals out of the reach of children, animals, or other unauthorized people. When not in use, store chemicals in a safe place. Never blow through nozzles, valve, pipes or any other component by mouth!

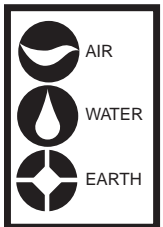

When handling chemicals and when spraying, make sure you are operating in accordance with local, state, and federal environmental protection rules and guidelines. Do not spray in very hot or windy conditions. **DO NOT POLLUTE THE ENVIRONMENT!**



After spray application, take a thoroughly cleansing shower using plenty of water and soap, then change into clean clothes. Protective clothing and safety gear should also be cleaned after each use. **IN CASE OF EXPOSURE TO DANGEROUS CHEMICALS, seek a physician immediately and be prepared to provide the label from the chemical container.**

## Calibrating the Sprayer

(Requires optional flow calibrator bottle, P/N 646901)

1. Hold the wand at the working height and spray a test pattern to measure the application band width.
2. Based on the band width, identify from the table below the walking distance required to calibrate the sprayer.

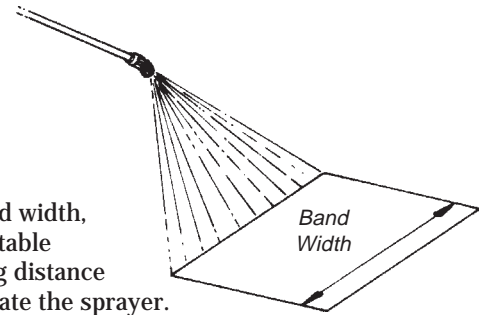

Band width	1.6 ft 0.5m	2.3 ft 0.7m	3.3 ft 1.0m	4.0 ft 1.2m	5.0 ft 1.5m
Distance to walk	165 ft 50.0m	120 ft 35.7m	80 ft 25.0m	70 ft 20.8m	55 ft 16.7m

3. Attach the flow calibrator bottle to the wand:
  - a. Remove the nozzle, cap and filter from the spray wand.
  - b. Mount the flow calibrator cover to the spray wand.
  - c. Reinstall the nozzle, filter and nozzle cap.
  - d. Screw the flow calibrator bottle into the cover.

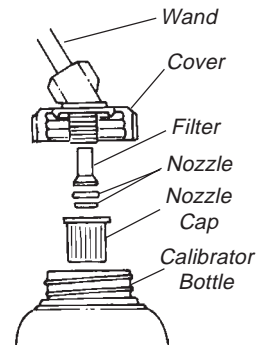

4. Using the flow calibrator bottle:
  - a. Operate the pump handle to maintain spray system pressure as you would when applying chemicals.
  - b. Hold the wand at your normal working position and spray into the bottle while walking the distance identified in step 2 above.
  - c. Place the bottle on a level surface and observe the liquid level visible through the side of the bottle. Match the liquid level to the 1/acre (liter per acre) scale on the calibration bottle.
  - d. Multiply the 1/acre (liter per acre) reading identified in step 4-c by .264 to determine your application coverage rate in gallons per acre.
  - e. Empty the bottle contents back into the sprayer tank.

### NOTE:

For improved accuracy in calibrating your application coverage, repeat steps 4-a through 4-e and average the results.

## Typical Nozzle Assemblies

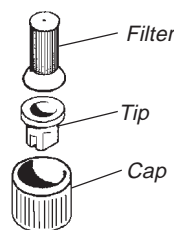

Flat Fan Nozzle

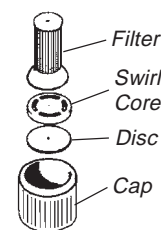

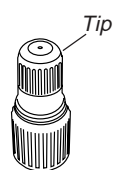

Cone Nozzle





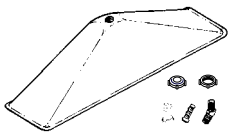
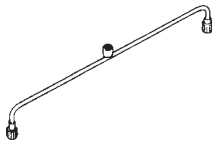
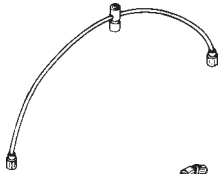
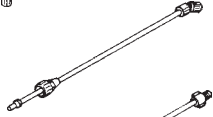
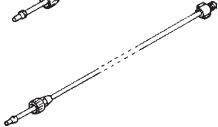
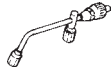

The spraying angle is changed by turning the tip





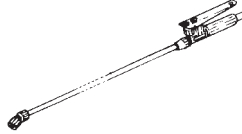
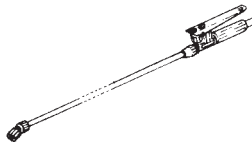

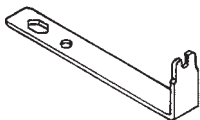
Adjustable Cone Nozzle

# Optional Accessories

Part Number	Description
	<b>761882</b> Spray hood is used for nonselective herbicides when spraying under windy conditions. Comes with Kematal 110-DEF-06 deflector fan nozzle and parts to assemble spray hood to your existing Shindaiwa spray wand.
	<b>902296</b> Brass spray boom (27.5") for use with agrochemicals and foliar fertilizers applied to row crops. Provides 40" coverage. JD-12P cone nozzles and 40 mesh stainless steel filter included.
	<b>907873</b> Flexible annealed copper boom fitted with three JD-12P cone nozzles. For use with agrochemicals and foliar fertilizers on row crops. Can be easily shaped as appropriate to provide proper coverage. 40 mesh stainless steel filter included.
	<b>831107</b> Brass extension (11.8") complete with plastic fittings for extra reach. Attachable to original wand.
	<b>728139</b> Brass extension (23.6") complete with plastic fittings for extra reach. Attachable to original wand.
	<b>100016</b> Brass extension (6.3") complete with two JD-12P cone nozzles for doubling output of agrochemicals and foliar fertilizers on perennials. 40 mesh stainless steel filter included.
	<b>646901</b> Flow calibrator bottle. For accurate calibration of backpack sprayers to prevent waste and damage to the environment.
	<b>336115</b> Brass Y nozzle for use on plants requiring heavy applications of fungicides. Complete with two JD-12P cone nozzles, 40 mesh stainless steel filter and plastic fittings.

Part Number	Description
	<b>838052</b> Constant pressure valve reduces pumping action, reduces drift and delivers uniform spraying. Improves productivity and saves chemicals.
	<b>565648</b> Plastic anti-drip valve for agrochemicals and foliar fertilizer application. Attaches to wand and is compatible with any type of cone or flat fan nozzle.
	<b>568774</b> Spray wand assembly (21.6") Plastic handle, trigger valve and spray tube. 40 mesh stainless steel nozzle and trigger valve filters included. Fitted with adjustable cone nozzle.
	<b>725267</b> All brass spray wand assembly (21.6") for extra duty applications. Trigger valve and spray tube are brass. 40 mesh stainless steel nozzle and trigger valve filters included. Fitted with JD-12P cone nozzle.
	<b>229724</b> Nozzle cap for attaching flat fan and cone type nozzles.
	<b>452284</b> All Purpose Wrench for periodic maintenance and repair.

## AVAILABLE SPRAY NOZZLES

Nozzle Type	Part Number	Application	Pressure psi (kg/sq.cm)	Flow Rate gal (ml)/min
	437756 110-SF-015 Kematal green, 0.16 gpm @ 45 psi	Herbicides	45 (3.2)	0.16 (610)
	437764 110-SF-02 Kematal yellow, 0.21 gpm @ 45 psi		45 (3.2)	0.21 (810)
	437772 110-SF-03 Kematal blue, 0.33 gpm @ 45 psi		45 (3.2)	0.33 (1250)
	717942 JD-10A Stainless steel	Agrochemicals and foliar fertilizers	45 (3.2)	0.08 (300)
	217174 JD-12P Stainless steel		45 (3.2)	0.16 (615)
	437855 110-LD-03 Kematal blue, 0.33 gpm @ 45 psi		45 (3.2)	0.16 (615)
			45 (3.2)	0.22 (830)
	457317 HC-02 Kematal yellow		45 (3.2)	0.44 (1680)
	457325 HC-04 Kematal red		15 (1.0)	0.54 (2060)
	457333 HC-05 Kematal brown		15 (1.0)	0.25 (950)
	457390 DEF-04 Kematal red		15 (1.0)	0.32 (1200)
	457408 DEF-05 Kematal brown		45 (3.2)	0.41 (1540)
	457416 DEF-06 Kematal gray		45 (3.2)	0.41 (1540)
	323725 Yellow 0.08 gpm @ 45 psi.	45 (3.2)	0.08 (315)	
	015024 Red 0.17 gpm @ 45 psi.	45 (3.2)	0.17 (640)	
	325787 Blue 0.18 gpm @ 45 psi.			

**Note:** All Shindaiwa sprayers come with the red adjustable cone nozzle P/N 015024 installed as standard equipment.

# Maintenance

## Cleaning the Sprayer



### WARNING!

Always relieve pressure from the sprayer tank by pulling the pressure relief valve before removing the tank lid.

After finishing the spray application, empty the sprayer and wash all equipment in an approved decontamination area.

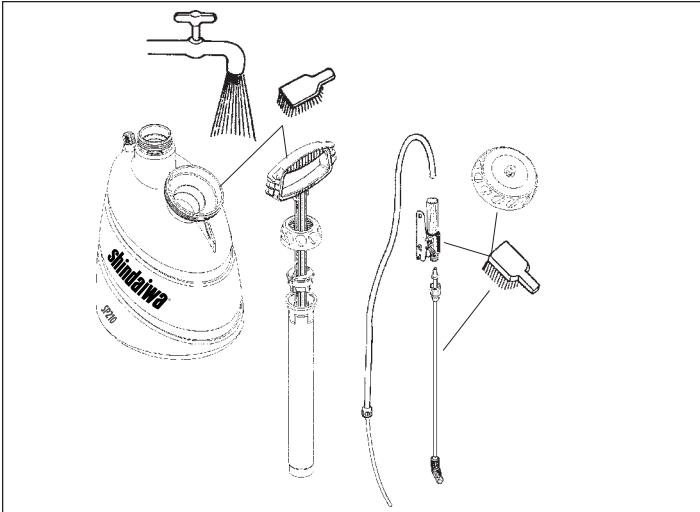

### WARNING!

Remove all chemicals and wash before storing the sprayer. Chemical products have different reactions and can cause damage to the sprayer components and the environment. Unidentified chemicals left in the sprayer tank can pose a serious health threat to anyone servicing the unit and unaware of its presence!

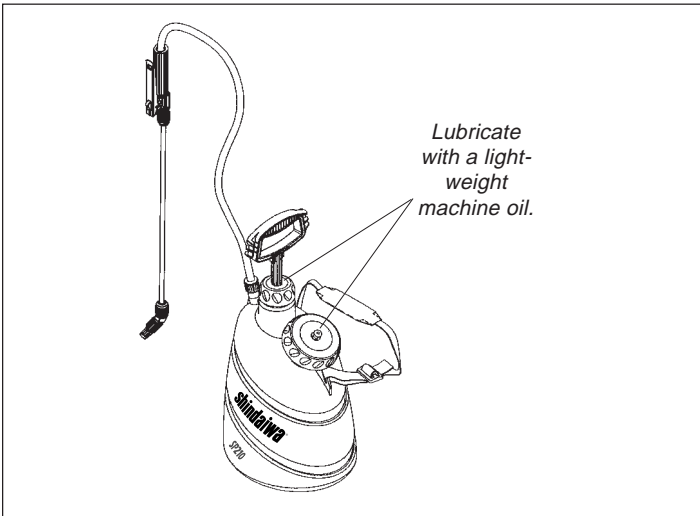

Periodically lubricate the pump handle, bushings and tank lid pressure relief valve with a light-weight machine oil.

## Pump Disassembly

1. Unscrew the cylinder cap and remove the pump chamber piston assembly from the tank.
2. Pull the pump piston out of the pump chamber.
3. Remove the piston cup from the pump piston.
4. Remove the diaphragm valve from the pump chamber.
5. Clean all parts and carefully inspect for worn or damaged parts and replace as necessary.
6. Reassemble in the reverse order.

### NOTE:

Lubricating all moving parts with a high quality lithium grease will ease assembly and prolong the life of the unit.

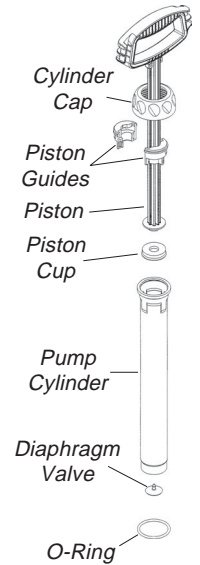

## Troubleshooting

SYMPTOM	CAUSE	REMEDY
Lack of sprayer pressure and/or leakage at the cylinder.	Worn or damaged diaphragm valve and piston cup.	Replace the diaphragm valve and piston cup.
After pumping and pressurizing the tank, the pump handle rises slowly when released prior to being locked in place.	Diaphragm valve not sealing properly due to wear or impurities.	Clean or replace the diaphragm valve.
Sprayer will not hold pressure.	Hose seal, cap seal or pump chamber o-ring damaged.	Replace seals as necessary.
Tank lid difficult to remove.	Pressure relief valve inoperative.	Replace tank lid.

# Illustrated Parts List (SP210)

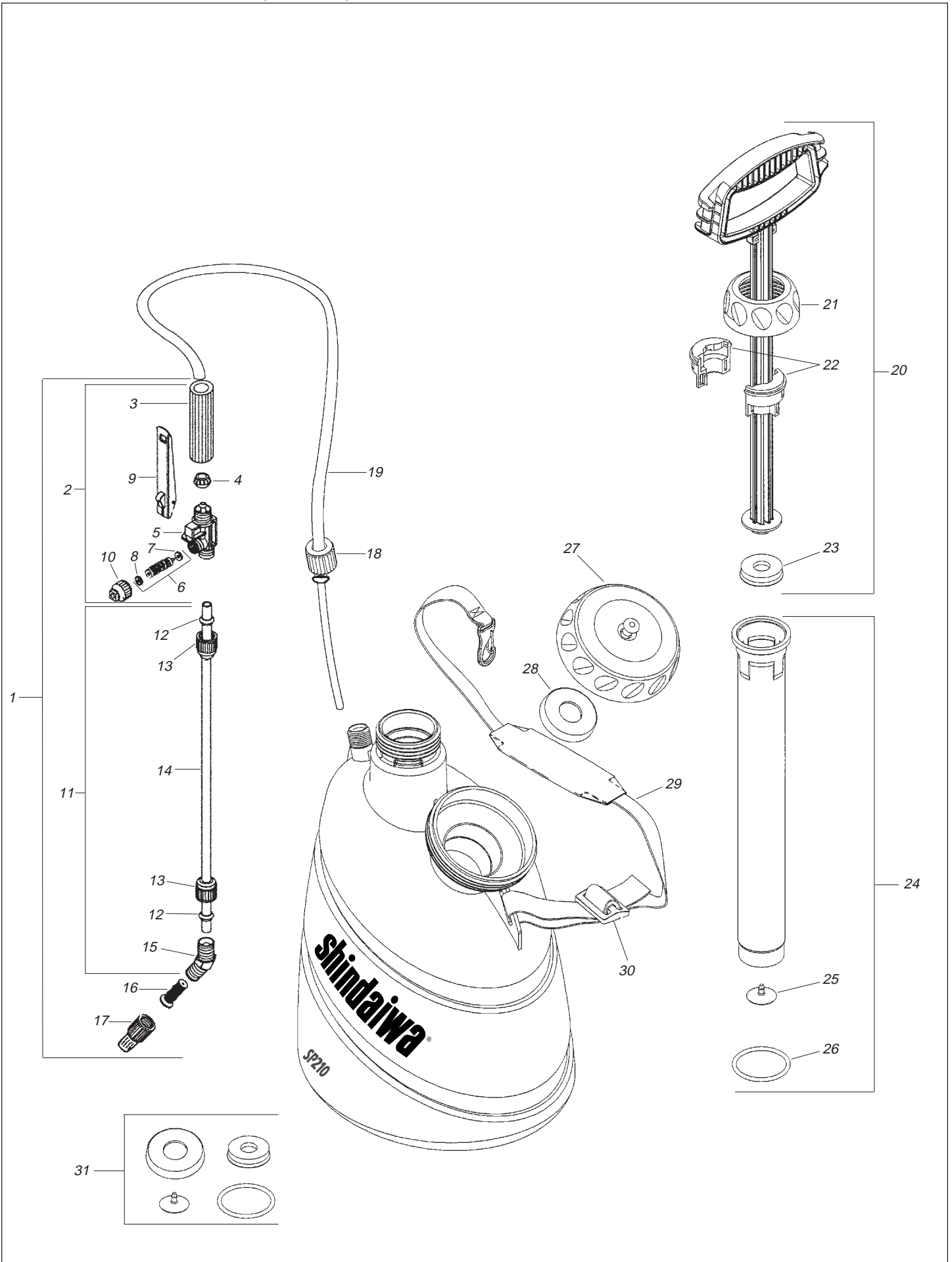

## Illustrated Parts List (SP210)

No.	Part Number	ItemDescription	Qty.
<b>1</b>	<b>568774</b>	<b>Spray wand assembly</b>	<b>1</b>
2	568782	Trigger valve assembly	1
3	909192	Trigger valve handle	1
4	920470	Hose ferrule	1
5	909283	Trigger valve body	1
6	105239	Trigger valve needle assembly	1
7	300731	Lower seal 30x88x25	1
8	300764	Upper seal 50x96x35	1
9	568972	Trigger	1
10	996058	Trigger valve cap	1
11	568873	Spray tube assembly	1
12	909309	Cone packing	2
13	915744	Screw cap	2
14	336263	Spray tube	1
15	635276	Elbow	1
16	730366	Nozzle filter 40 mesh	1
17	015024	Adjustable cone nozzle	1
18	942193	Screw cap S-20	1
19	048116	Hose/dip tube assembly	1
<b>20</b>	<b>285312</b>	<b>Pump handle assembly</b>	<b>1</b>
21	285296	Cylinder cap	1
22	285288	Bushing	2
23	147678	Piston cup, Nitrilic	1
<b>24</b>	<b>285262</b>	<b>Cylinder assembly</b>	<b>1</b>
25a	964270	Diaphragm valve, Viton®	1
25b	560573	Diaphragm valve, Nitrilic (optional)	1
26	010533	O-Ring ORI-224	1
27	285247	Tank lid	1
28a	148072	Tank lid gasket, Nitrilic	1
28b	285346	Tank lid gasket, Viton® (optional)	1
<b>29</b>	<b>148064</b>	<b>Strap &amp; buckle assembly</b>	<b>1</b>
30	502757	Strap buckle	1
31	285320	Seal kit (optional)	1



# Shindaiwa Limited Warranty

Shindaiwa Inc. manufactures its products to superior standards of quality to ensure customers obtain the highest level of satisfaction. In keeping with this goal, Shindaiwa Inc. warrants the SP210 sprayer to the original purchaser as follows:

## Warranty Period

One year from the delivery date to the original purchaser for consumer and commercial applications.

90 days for rental applications.

## Warranty Administration

Within the covered warranty period, Shindaiwa Inc. will, at their option, repair or replace any defect in material or workmanship, without charge for parts or labor, if this product is presented at an authorized Shindaiwa dealer.

## Warranty Exclusions and Limitations

Shindaiwa Inc. assumes no responsibility for damages, loss, or injury resulting from:

- Normal wear and tear
- Misuse or neglect
- Modifications to or removal of original component parts

The warranty is limited to the terms stated herein. Shindaiwa Inc. disclaims all liability for incidental or consequential damages. Some states do not allow the exclusion of incidental or consequential damages, so these limitations may not apply to you.

This warranty give you specific legal rights, and you may also have other rights which may vary from state to state.

Shindaiwa reserves the right to change the design or specifications of this product without obligation to modify previously manufactured products.

## Owner's Responsibilities

The owner of the sprayer must demonstrate reasonable care in the use, maintenance, and storage of this Shindaiwa product. If a warrantable failure should occur, the owner must deliver the product to an authorized Shindaiwa servicing dealer for correction. All residual chemicals must be flushed from the sprayer prior to delivery.

## **Unidentified chemicals left in the sprayer tank can pose a serious health threat to anyone servicing the unit and unaware of its presence!**

To obtain warranty service, proof of purchase must be presented to the authorized Shindaiwa servicing dealer when the product is presented for repairs.

Proof of purchase must include date of purchase and the name and address of the selling dealer.











# shindaiwa

Shindaiwa Inc.

11975 S.W. Herman Road

Tualatin, Oregon 97062

Telephone: 503 692-3070

Fax: 503 692-6696

[www.shindaiwa.com](http://www.shindaiwa.com)

©2006 Shindaiwa, Inc.

Part Number 80555

Revision 7/06

Shindaiwa is a registered trademark  
of Shindaiwa, Inc.

Specifications subject to change without notice.

Printed in Brazil