

ACN-C CUTOFF GENERATION SERIES

50-400W
MH/HPS/QL

DECORATIVE LUMINAIRE



STREETWORKS™

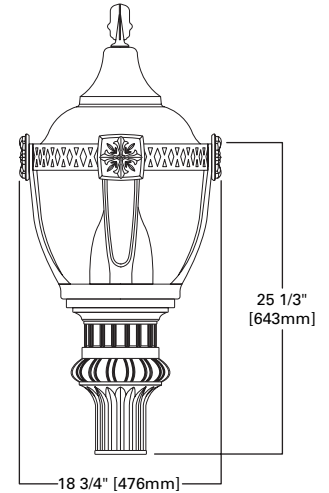

TOPS + FINIALS

All hard mount tops are made of spun aluminum. Nostalgic and architectural tops are provided with toolless access for ease of maintenance. Finials are manufactured of cast aluminum.

REFLECTOR

Highly specular multi-faceted CVL reflector system provides a Type III or V Cutoff Distribution. Vertical lamp position maximizes light output, ensures a uniform distribution and minimizes direct glare.

GLOBE

Clear injection molded 9" globe is offered in UV resistant acrylic.

DECORATIVE CHIMNEY

Chimney provided with brushed aluminum finish standard. Optional copper finished accents available for chimney and access top.

CAGE ASSEMBLIES

All uprights are manufactured of cast aluminum. Banding is extruded aluminum. All cage assemblies are mounted to the exterior of the housing via four (4) stainless steel fasteners. A variety of finishes are available.

ELECTRICAL

Available up to 400W MH and 250W HPS. Ballast assembly is mounted on a removable tray with quick disconnects for ease of installation and maintenance. Plug in starter standard when applicable. Terminal block is hard mounted to the casting and easily accessible through the door's wide entryway. UL listing and optional induction fluorescent lamp available.

HOUSING

Heavy duty-cast aluminum housing and door. Wide handhole provide toolless entry for access to plug-in starters and optional NEMA twistlock PCR. 1" ANSI wattage/source label. Fixture is 3G vibration rated.

MOUNTING

Post top mount fits 3" OD tenons. Four (4) stainless steel fasteners standard.

FINISH

Standard polyester powder coat finish in black. For more color options see optional color or consult your Streetworks representative for more information.

EPA:

Effective Projective Area: 2.1

SHIPPING DATA

Approximate Net Weight:

50 lbs. (23 kgs.)

ORDERING INFORMATION

SAMPLE NUMBER: ACN25MWW5C373

| PRODUCT FAMILY | LAMP WATTAGE ³ | LAMP TYPE ³ | BALLAST TYPE ³ | VOLTAGE ³ | REFRACTOR TYPE | CAGE TYPE ⁷ | TOP TYPE | FINIAL TYPE | OPTIONS (See Below) |
|----------------|---|---|--|--|------------------------------|---|---|---|---------------------|
| ACN=Acorn | 50=50W 70=70W 85=85W ¹ 10=100W 15=150W 17=175W 25=250W 40=400W ² | M=Metal Halide ⁴ S=High Pressure Sodium Q=Induction ¹ | R=Reac./NPF ⁵ H=Reac./HPF N=Hi. Reac./NPF P=Hi. Reac./HPF W=CWA K=10KV CWA ⁶ I=Induction | 2=120V 0=208V 4=240V 7=277V 8=480V 9=347V W=Multi-Tap wired 120V N=Multi-Tap wired 277V | 3C=Cutoff III 5C=Cutoff V | 1=CLASSICAL A=Classical/Sun Gold B=Classical/Antique Gold C=Classical/Colonial Bronze 2=MODERN D=Modern/Sun Gold E=Modern/Antique Gold F=Modern/Colonial Bronze 3=ARCHITECTURAL G=Architectural/Sun Gold H=Architectural/Antique Gold J=Architectural/Colonial Bronze X=None | 4=Classical 6=Nostalgic (Top Access) 7=Architectural (Top Access) | 1=Victorian 2=Modern 3=Architectural 4=Nostalgic | |

OPTIONS [Must be ordered in alphanumeric order]

- OPTIONS (add as suffix)
- 1=Single Fuse (120 or 277V)
- 2=Double Fuse (208, 240 or 480V)
- Y=Black Chimney
- 4=Internal NEMA photocontrol Receptacle
- P=Polycarbonate Refractor⁸
- WH=White
- BZ=Bronze
- AP=Grey
- DP=Dark Platinum
- H=Hartford Green
- U=UL Listed
- C=Copper Accents⁹

OPTIONAL COLORS [Standard color is black, other finish colors available. Consult your Cooper Lighting representative]



OPTIONAL METALLIC COLORS [Classical, Modern, and Architectural Cage Type Only]⁷



NOTE: 1 85W QL Induction only. 120 or 240V only. 2 Metal Halide only. Not available in 480V. 3 Refer to technical section for lamp/ballast/voltage compatibility. 4 Medium-base lamp standard for 150W and below Metal Halide. 400W Metal Halide requires reduced jacket ED28 lamp. 5 Available 120V only. 6 Available 50-150W, 120/240 or single voltage only. 7 Cage Type 1, 2, 3 will be finished same color as base. 8 Polycarbonate parts used with Metal Halide lamps will eventually yellow. 9 Chimney and Access Top finished in copper.

PHOTOMETRICS [Complete IES files available at www.cooperlighting.com]

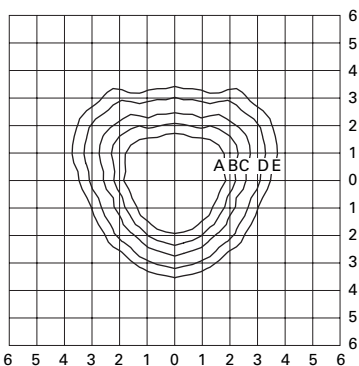

ACN15S3C.IES
150-Watt HPS
16,000-Lumen Clear ED-23.5 Lamp
Type III Cutoff

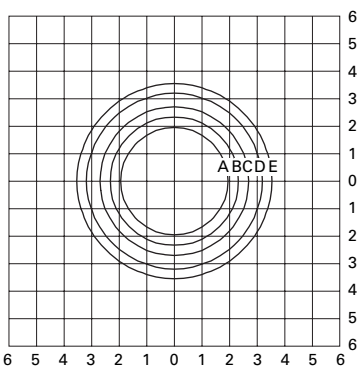

ACN15S5C.IES
150-Watt HPS
16,000-Lumen Clear ED-23.5 Lamp
Type V Cutoff

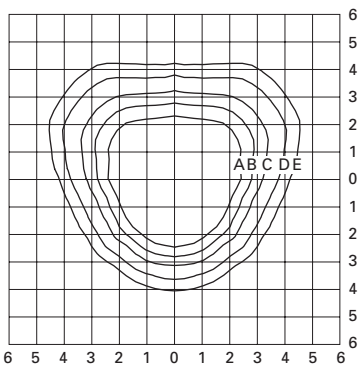

ACN17M3C.IES
175-Watt MH
14,000-Lumen Clear ED-28 Lamp
Type III Cutoff

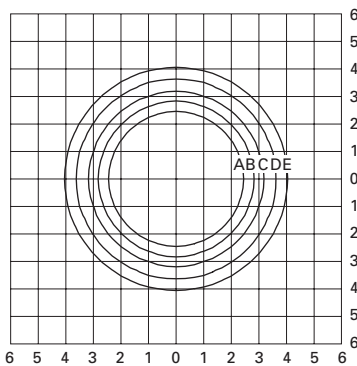

ACN17M5C.IES
175-Watt MH
14,000-Lumen Clear ED-28 Lamp
Type V Cutoff

FOOTCANDLE TABLE

Select mounting height and read across for footcandle values of each isofootcandle line. Distance in units of mounting height.

| Mounting Height | Footcandle Values for Isofootcandle Lines | | | | |
|-----------------|---|------|------|------|------|
| | A | B | C | D | E |
| 10' | 4.50 | 2.25 | 1.12 | 0.45 | 0.22 |
| 15' | 2.00 | 1.00 | 0.50 | 0.20 | 0.10 |
| 20' | 1.12 | 0.56 | 0.28 | 0.11 | 0.05 |

ACN15S5C.IES

| | | | | | |
|-----|------|------|------|------|------|
| 10' | 4.50 | 2.25 | 1.12 | 0.45 | 0.22 |
| 15' | 2.00 | 1.00 | 0.50 | 0.20 | 0.10 |
| 20' | 1.12 | 0.56 | 0.28 | 0.11 | 0.05 |

FOOTCANDLE TABLE

Select mounting height and read across for footcandle values of each isofootcandle line. Distance in units of mounting height.

| Mounting Height | Footcandle Values for Isofootcandle Lines | | | | |
|-----------------|---|------|------|------|------|
| | A | B | C | D | E |
| 10' | 2.00 | 1.00 | 0.50 | 0.20 | 0.10 |
| 15' | 0.88 | 0.44 | 0.22 | 0.09 | 0.04 |
| 20' | 0.50 | 0.25 | 0.3 | 0.05 | 0.03 |

ACN17M5C.IES

| | | | | | |
|-----|------|------|------|------|------|
| 10' | 2.00 | 1.00 | 0.50 | 0.20 | 0.10 |
| 15' | 0.88 | 0.44 | 0.22 | 0.09 | 0.04 |
| 20' | 0.50 | 0.25 | 0.3 | 0.05 | 0.03 |

CONFIGURATIONS

CAGE TYPE

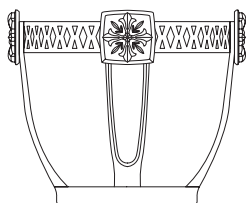

Classical

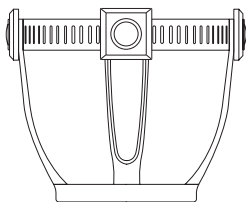

Modern

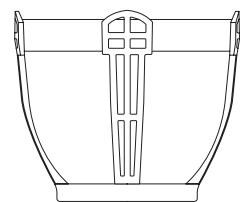

Architectural

TOP TYPE

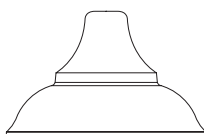

Classical

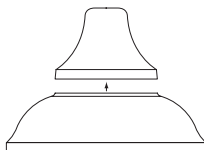

Nostalgic (Top Access)

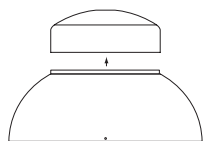

Architectural (Top Access)

FINIAL TYPE



Architectural



Modern



Victorian



Nostalgic