



Use and Care & Installation Guide

Self-Cleaning Radiant Range



Safety Instructions 3-5
 Anti-Tip Device 3, 30, 38



Operating Instructions, Tips

Aluminum Foil..... 19, 23-25
 Clock and Timer 16
 Control Panel..... 15
 Features..... 6, 7
 Oven 17-28
 Auto Oven Shut Off..... 17
 Baking 18, 19
 Broiling..... 25, 26
 Roasting 23, 24
 Self-Cleaning Instructions 27-29
 Timed Baking 20, 21
 Power Outage 16
 Surface Cooking 10-14
 Canning Tips..... 13
 Control Settings..... 10
 Cooktop Comparison 8, 9
 Cookware Tips..... 11, 12
 Surface Cleaning 14



Care and Cleaning 30-34
 Anti-Tip Device 30
 Door Removal 32
 Glass Cooktop..... 14
 Oven Light..... 30
 Self-Cleaning Instructions 27-29



Problem Solver 39-41
 Thermostat Adjustment-
 Do It Yourself..... 22
 More questions?...call
GE Answer Center® 800.626.2000



Installation 34-38
 Anti-Tip Device 34, 38
 Flooring Under the Range..... 35
 Leveling 36



Consumer Services 42, 43
 Appliance Registration..... 2
 Important Phone Numbers..... 43
 Model and Serial Number Location..... 2
 Warranty Back Cover

<i>Models:</i>	<i>JBP60</i>	<i>JBP76</i>
	<i>JBP65</i>	<i>JBP77</i>
	<i>JBP75</i>	<i>JBP78</i>

GE Appliances

164D2966P234
49-8723





Congratulations! You have just purchased one of the most innovative and exciting products on the market today. A great deal of research and technology has gone into the development of this appliance, and we believe that by choosing GE, you have made a wise investment that will provide years of enjoyment. With this range you not only get the assurance of GE quality, but many other exceptional features.

Quick Cooking Response

- With radiant heating surface units you get fast, uniform cooking. The heat cycles on and off to maintain the temperature level.

QuickClean™ Design

- Hard to clean cracks and crevices are eliminated. The full-width glass cooktop is sealed to the porcelain enamel spill-proof frame. The raised edges and recessed top contain spills.

Glass Cooktop

- This durable “glass ceramic” material is impact, stain and scratch resistant.

QuickSet Self-Clean Oven Controls

- QuickSet controls make setting the self-clean cycle easy. The controls also feature Auto Oven Shut-Off, electronic clock and timer, automatic oven timer, a single control knob, a preheat light and signal and more.

Safety Features

- The four hot surface indicator lights let you know which surface unit is turned on or still too hot to touch.

“Big View” Window (on some models)

- An exclusive feature from GE, the big window makes it easy to check baking progress without opening the door.

HELP US HELP YOU...

Before using your range, read this guide carefully.

It is intended to help you operate and maintain your new range properly.

Keep it handy for answers to your questions.

If you don't understand something or need more help, call:

GE Answer Center®

800.626.2000

24 hours a day, 7 days a week

Write down the model and serial numbers.

You'll find them on a label behind the range door or behind the storage drawer or kick panel.

These numbers are also on the Consumer Product Ownership Registration Card that came with your range. Before sending in this card, please write these numbers here:

Model Number

Serial Number

Use these numbers in any correspondence or service calls concerning your range.

If you received a damaged range...

Immediately contact the dealer (or builder) that sold you the range.

Save time and money.

Before you request service...

Check the Problem Solver in the back of this guide. It lists causes of minor operating problems that you can correct yourself.

IMPORTANT SAFETY INSTRUCTIONS

Read all instructions before using this appliance.



IMPORTANT SAFETY NOTICE

- **The California Safe Drinking Water and Toxic Enforcement Act** requires the Governor of California to publish a list of substances known to the state to cause birth defects or other reproductive harm, and requires businesses to warn customers of potential exposure to such substances.
- **The fiberglass insulation in self-clean ovens gives off a very small amount of carbon monoxide during the cleaning cycle.** Exposure can be minimized by venting with an open window or using a ventilation fan or hood.
- **Fluorescent light bulbs contain mercury.** If your model has a surface light, you must recycle the fluorescent light bulb according to local, state and federal codes.

When using electrical appliances, basic safety precautions should be followed, including the following:

- **Use this appliance only for its intended use** as described in this guide.
- **Be sure your appliance is properly installed and grounded** by a qualified technician in accordance with the provided installation instructions.
- **Do not attempt to repair or replace any part of your range unless it is specifically recommended in this guide.** All other servicing should be referred to a qualified technician.
- **Before performing any service, DISCONNECT THE RANGE POWER SUPPLY AT THE HOUSEHOLD DISTRIBUTION PANEL BY REMOVING THE FUSE OR SWITCHING OFF THE CIRCUIT BREAKER.**
- **Do not leave children alone**—children should not be left alone or unattended in an area where an appliance is in use. They should never be allowed to sit or stand on any part of the appliance.
- **Do not allow anyone to climb, stand or hang on the door, kick panel or storage drawer or cooktop.** They could damage the range and even tip it over, causing severe personal injury.
- **Do not store flammable materials in an oven or near the cooktop.**

▲ WARNING—

All ranges can tip and injury could result. To prevent accidental tipping of the range, attach it to the wall and floor by installing the Anti-Tip device supplied.

To check if the device is installed and engaged properly, remove the kick panel or storage drawer and inspect the rear leveling leg. Make sure it fits securely into the slot.

If you pull the range out from the wall for any reason, make sure the device is properly engaged when you push the range back against the wall. If it is not, there is a possible risk of the range tipping over and causing injury if you or a child stand, sit or lean on an open door.

Please refer to the Anti-Tip device information in this guide. Failure to take this precaution could result in tipping of the range and injury.

- **CAUTION: ITEMS OF INTEREST TO CHILDREN SHOULD NOT BE STORED IN CABINETS ABOVE A RANGE OR ON THE BACKSPASH OF A RANGE—CHILDREN CLIMBING ON THE RANGE TO REACH ITEMS COULD BE SERIOUSLY INJURED.**

- **Never wear loose-fitting or hanging garments while using the appliance.** Be careful when reaching for items stored over the range. Flammable material could be ignited if brought in contact with hot surface units or heating elements and may cause severe burns.



- **Use only dry pot holders**—moist or damp pot holders on hot surfaces may result in burns from steam. Do not let pot holders touch hot surface units or heating elements. Do not use a towel or other bulky cloth.
- **For your safety, never use your appliance for warming or heating the room.**
- **DO NOT STORE OR USE COMBUSTIBLE MATERIALS, GASOLINE OR OTHER FLAMMABLE VAPORS AND LIQUIDS IN THE VICINITY OF THIS OR ANY OTHER APPLIANCE.**

(continued next page)



IMPORTANT SAFETY INSTRUCTIONS

(continued)

- **Keep the hood and grease filters clean to maintain good venting and to avoid grease fires.**
- **Do not let cooking grease or other flammable materials accumulate in or near the range.**



- **Do not use water on grease fires. Never pick up a flaming pan.** Turn the controls off. Smother a flaming pan on a surface unit by covering the pan completely with a well-fitting lid, cookie sheet or flat tray. Use a multi-purpose dry chemical or foam-type fire extinguisher.

Flaming grease outside a pan can be put out by covering it with baking soda or, if available, by using a multi-purpose dry chemical or foam type fire extinguisher.

Flame in the oven can be smothered completely by closing the oven door and turning the oven off or by using a multi-purpose dry chemical or foam-type fire extinguisher.

- **Do not touch the surface units, the heating elements or the interior surface of the oven.** These surfaces may be hot enough to burn even though they are dark in color. During and after use, do not touch, or let clothing or other flammable materials contact the surface units, areas nearby the surface units or any interior area of the oven; allow sufficient time for cooling, first.

Potentially hot surfaces include the cooktop, areas facing the cooktop, oven vent opening, surfaces near the opening, crevices around the oven door and metal trim parts above the door.

Remember: The inside surface of the oven may be hot when the door is opened.

- **When cooking pork,** follow the directions exactly and always cook the meat to an internal temperature of at least 170°F. This assures that, in the remote possibility that trichina may be present in the meat, it will be killed and the meat will be safe to eat.

Oven

- **Stand away from the range when opening the oven door.** Hot air or steam which escapes can cause burns to hands, face and/or eyes.
- **Do not heat unopened food containers.** Pressure could build up and the container could burst, causing an injury.



- **Keep the oven vent unobstructed.**
- **Keep the oven free from grease buildup.**
- **Place the oven shelf in the desired position while the oven is cool.** If shelves must be handled when hot, do not let pot holder contact the heating elements.
- **Pulling out the shelf to the shelf stop is a convenience in lifting heavy foods.** It is also a precaution against burns from touching hot surfaces of the door or oven walls.
- **When using cooking or roasting bags in the oven,** follow the manufacturer's directions.
- **Do not use your oven to dry newspapers.** If overheated, they can catch on fire.
- **Do not use oven for a storage area.** Items stored in an oven can ignite.
- **Do not leave paper products, cooking utensils or food in the oven when not in use.**

Self-Cleaning Oven

- **Do not clean the door gasket.** The door gasket is essential for a good seal. Care should be taken not to rub, damage or move the gasket.
- **Do not use oven cleaners.** No commercial oven cleaner or oven liner protective coating of any kind should be used in or around any part of the oven. Residue from oven cleaners will damage the inside of the oven when the self-clean cycle is used.
- **Clean only parts listed in this Use and Care Guide.**
- **Before self-cleaning the oven,** remove the broiler pan, grid and other cookware.
- **Be sure to wipe up excess spillage before starting the self-cleaning operation.**
- **If the self-cleaning mode malfunctions,** turn the oven off and disconnect the power supply. Have it serviced by a qualified technician.



Cooktop and Radiant Surface Units

- **Use proper pan size**—Select cookware having flat bottoms large enough to cover the selected surface unit. The use of undersized cookware will expose a portion of the surface unit to direct contact and may result in ignition of clothing. Proper relationship of the cookware to the surface units will also improve efficiency.
- **Never leave the surface units unattended at high heat settings.** Boilovers cause smoking and greasy spillovers that may catch on fire.
- **Do not operate the radiant surface units if the glass is broken.** Spillovers or cleaning solution may penetrate a broken cooktop and create a risk of electrical shock. Contact a qualified technician immediately should your glass cooktop become broken.
- **Avoid scratching the glass cooktop.** The cooktop can be scratched with items such as sharp instruments, rings or other jewelry and rivets on clothing.
- **Never use the glass cooktop surface as a cutting board.**
- **Do not place or store items that can melt or catch fire on the glass cooktop,** even when it is not being used.
- **Be careful when placing spoons or other stirring utensils on glass cooktop surface** when it is in use. They may become hot and could cause burns.
- **To minimize the possibility of burns,** ignition of flammable materials and spillage, the handle of a container should be turned toward the center of the range without extending over the nearby surface units.
- **Always turn the surface units off before removing cookware.**
- **Keep an eye on foods being fried at high or medium high heat settings.**
- **When flaming foods are under the hood, turn the fan off.** The fan, if operating, may spread the flame.

- **Foods for frying should be as dry as possible.** Frost on frozen foods or moisture on fresh foods can cause hot fat to bubble up and over the sides of the pan.
- **Use little fat for effective shallow or deep-fat frying.** Filling the pan too full of fat can cause spillovers when food is added.
- **If a combination of oils or fats will be used in frying,** stir together before heating, or as fats melt slowly.
- **Always heat fat slowly,** and watch as it heats.
- **Use a deep fat thermometer whenever possible** to prevent overheating fat beyond the smoking point.

- **Clean the cooktop with caution.** If a wet sponge or cloth is used to wipe spills on a hot surface unit, be careful to avoid steam burns. Some cleaners can produce noxious fumes if applied to a hot surface.

NOTE: We recommend that you avoid wiping any surface unit areas until they have cooled and the indicator light has gone off. Sugar spills are the exception to this. Please see the Glass Cooktop Cleaning section.

When the cooktop is cool, use only the recommended cleaning cream to clean the cooktop.

- **Use care when touching the cooktop.** The glass surface of the cooktop will retain heat after the controls have been turned off.
- **To avoid possible damage to the cooking surface,** do not apply cleaning cream to the glass surface when it is hot.
- **After cleaning,** use a dry cloth or paper towel to remove all cleaning cream residue.
- **Read and follow all instructions and warnings on the cleaning cream labels.**

SAVE THESE INSTRUCTIONS



FEATURES OF YOUR RANGE

Not all features are on all models.

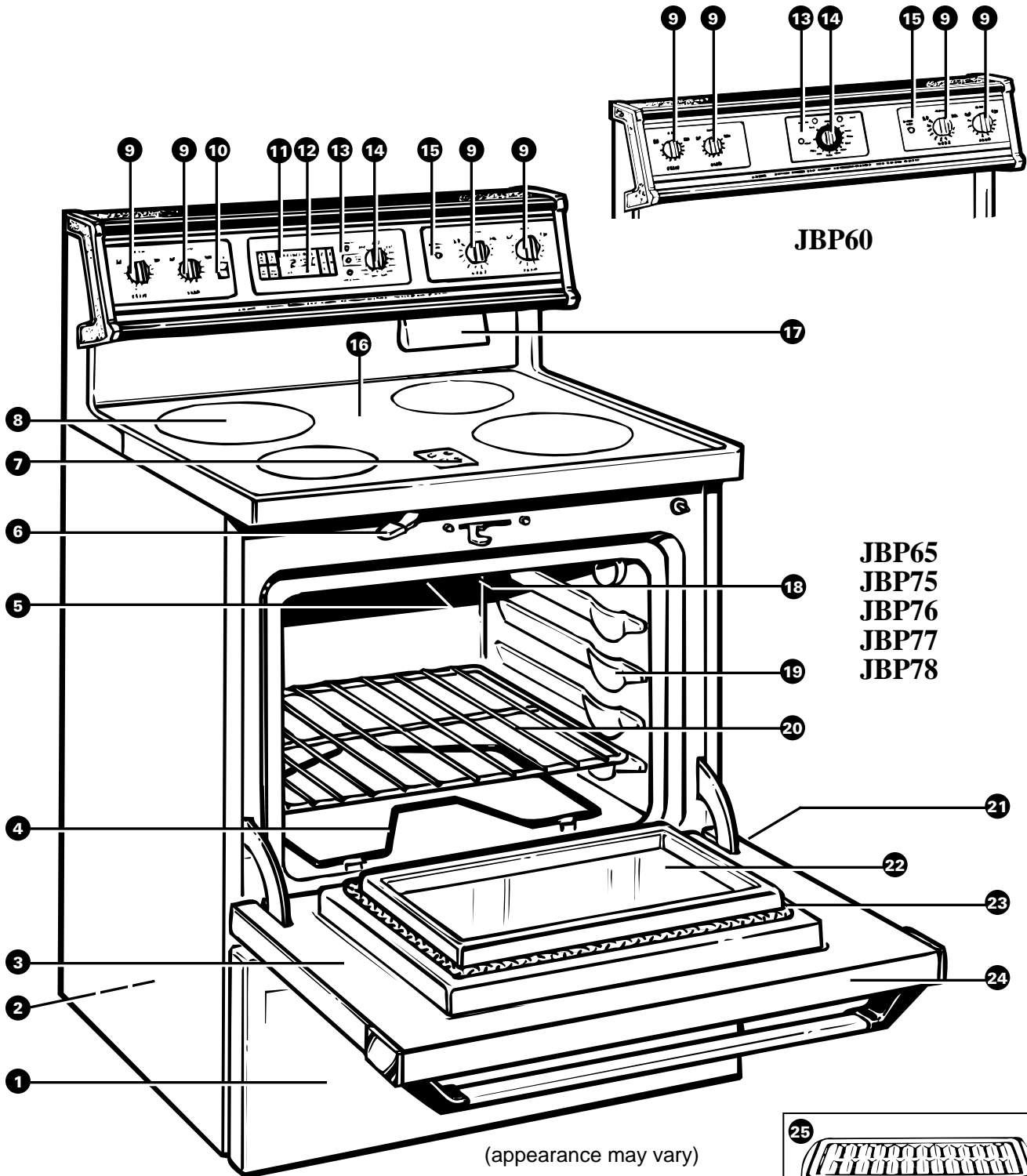

JBP60

JBP65
JBP75
JBP76
JBP77
JBP78

(appearance may vary)

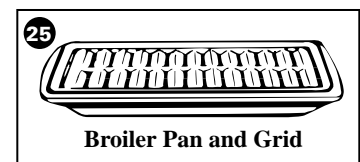

Broiler Pan and Grid



Feature Index Not all models have all features.	Explained on page
1 Storage Drawer or Kick Panel	3, 33
2 Anti-Tip Device See the Installation Instructions.	3, 30, 34
3 Anti-Tip Label	–
4 Bake Element May be lifted gently for wiping oven floor.	4, 32
5 Broil Element	4, 25, 32
6 Oven Door Latch Use for self-cleaning only.	18, 20, 23, 25, 27–29
7 Hot Surface Indicator Lights	9
8 Radiant Surface Units	3–5, 8–14
9 Surface Unit Control Knobs	10, 31
10 Oven Light Switch	17
11 AUTOMATIC OVEN Light	15, 20, 21
12 Clock and Timer	15
13 OVEN ON Light LATCH DOOR Light PREHEATED Light	15, 16, 22 15, 22, 28, 29 15, 16, 22
14 Oven Temperature Knob	15, 16, 22, 23, 25, 27–29, 31
15 Surface Unit “On” Light	10
16 Cooktop	5, 9–14
17 Oven Vent Located at the rear of the cooktop.	4, 31
18 Oven Interior Light Comes on automatically when the door is opened.	17, 27, 30
19 Oven Shelf Supports Shelf positions for cooking are suggested in the Baking, Roasting and Broiling sections.	4, 17, 18, 23, 24, 26
20 Oven Shelf with Stop-Locks (number may vary)	4, 17–19, 23, 28, 33
21 Model and Serial Number Location Behind the storage drawer.	2
22 “Big View” Window (on some models)	2, 20, 31
23 Oven Door Gasket	4, 27, 32
24 Lift-Off Oven Door with Broil Stop Position Easily removed for cleaning.	3, 25, 27, 32
25 Broiler Pan and Grid	4, 23, 25, 33







HOW DOES THIS COOKTOP COMPARE TO YOUR OLD ONE?

Your new range has a radiant glass cooktop. If you are used to cooking with gas burners or electric surface units, you will notice some differences when you use the radiant cooktop.

The best types of cookware to use, plus heat-up and cool-down times, depend upon the type of burner or surface unit you have.

The following chart will help you to understand the differences between radiant cooktops and any other type of cooktop you may have used in the past.

Type of Cooktop	Description	How it Works
Radiant (Glass Cooktop) 	Electric coils under a glass cooktop.	Heat travels to the glass surface and then to the cookware, so pans must be flat on the bottom for good cooking results. The glass cooktop stays hot enough to continue cooking after it is turned off. Remove the pan from the surface unit if you want cooking to stop.
Induction 	High frequency induction coils under a glass surface.	Pans must be made of ferrous metals (metal that attracts a magnet). Heat is produced by a magnetic circuit between the coil and the pan. Heats up right away and changes heat settings right away, like a gas cooktop. After turning the control off, the glass cooktop is hot from the heat of the pan, but cooking stops right away.
Electric Coil 	Flattened metal tubing containing electric resistance wire suspended over a drip pan.	Heats by direct contact with the pan and by heating the air under the pan. For best cooking results, use good quality pans. Electric coils are more forgiving of warped pans than radiant or solid disks. Heats up quickly but does not change heat settings as quickly as gas or induction. Electric coils stay hot enough to continue cooking for a short time after they are turned off.
Solid Disk 	Solid cast iron disk sealed to the cooktop surface.	Heats by direct contact with the pan, so pans must be flat on the bottom for good cooking results. Heats up and cools down more slowly than electric coils. The disk stays hot enough to continue cooking after it is turned off. Remove the pan from the solid disk if you want the cooking to stop.
Gas Burners 	Regular or sealed gas burners use either LP gas or natural gas.	Flames heat the pans directly. Pan flatness is not critical to cooking results, but pans should be well balanced. Gas burners heat the pan right away and change heat settings right away. When you turn the control off, cooking stops right away.



General Information About Radiant Surface Units

The radiant cooktop features heating units beneath a smooth glass surface. The surface units are shown by outlines on the glass.

Before you use the cooktop for the first time, clean it with cleaning cream. This helps protect the top and makes clean-up easier.

NOTE: A slight odor is normal when a new cooktop is used for the first time. It is caused by the heating of new parts and insulating materials and will disappear in a short time.

When a surface unit is turned on, coils beneath the surface unit radiate heat through the glass to the cookware. The red glow of the coils will be visible through the glass. It will take the surface unit a few moments to heat up. The coil cycles on and off to maintain your selected control setting. With poor cookware, you will see frequent cycling of the unit off and on. Good, flat cookware will minimize the cycling.

Use only flat-bottomed cookware. Do not let pots boil dry. Overheated metal can bond to glass cooktop. An overheated copper pot will leave a residue that will permanently stain the glass.

Sliding aluminum cookware across the glass may leave metal marks. These metal marks will appear as small scratches. They can be removed with cleaning cream and a razor scraper.

It is safe to place hot cookware from the oven or surface on the glass surface when the surface is cool.

Avoid sliding pans on the glass cooktop. Pan edges that are even slightly rough or grit on the cooktop can cause scratches on the glass.

Even after the surface units are turned off, the glass cooktop retains enough heat to continue cooking. To avoid overcooking, remove pans from the surface units when the food is cooked. Avoid placing anything on the surface unit until it has cooled completely.

The Hot Surface Lights will stay lit until the cooktop is safe to touch. It is not unusual for the lights to stay lit for 30 minutes.

Hot Surface Indicator Light

A “HOT SURFACE” light will glow brightly when any radiant element is turned on, and will remain lit after the unit is turned off until the surface is cool enough to touch. Each element has its own “HOT SURFACE” indicator light.

- It comes on instantly when the unit is turned on.
- It stays on even after the unit is turned off.
- It glows brightly until the unit is safe to touch.

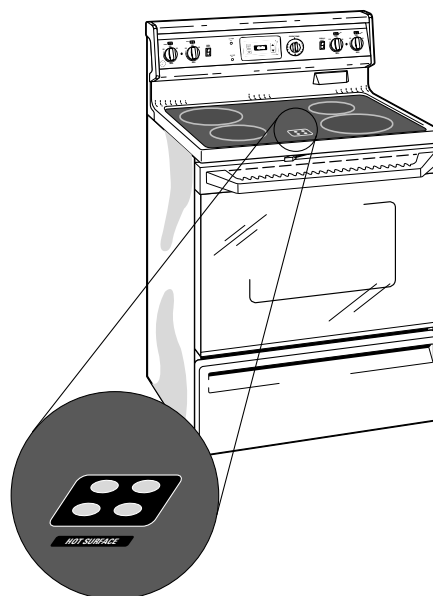

A “HOT SURFACE” light will glow brightly when any element is turned on.



SURFACE CONTROLS

At both OFF and HI the control “clicks” into position. You may hear slight “clicking” sounds during cooking, indicating the control is keeping the unit at the heat level or power level you set.

Switching heats to higher settings always shows a quicker change than switching to lower settings.

How to Set the Controls

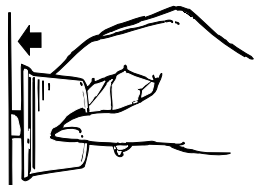

Push the knob in and turn in either direction to the setting you want.

Be sure you turn the control knob to OFF when you finish cooking.

The surface unit “on” indicator light will glow when ANY surface unit is on.

Cooking Guide for Using Heat Settings

HI—Used to begin cooking or to bring water to a boil. Reduce heat setting after water boils.

Medium High—(Setting halfway between HI and MED) Maintains a fast boil on large amounts of food.

MED—Sauté and brown; keeps food at a medium boil.

Medium Low—(Setting halfway between MED and LO) Cook after starting at HI; cooks with little water in covered pan.

LO—Used for long slow cooking (simmering) to tenderize and develop flavors. Use this setting to melt butter and chocolate or to keep foods warm.

NOTE: The surface unit “on” indicator light may glow between LO and OFF, but there is no power to the surface units.

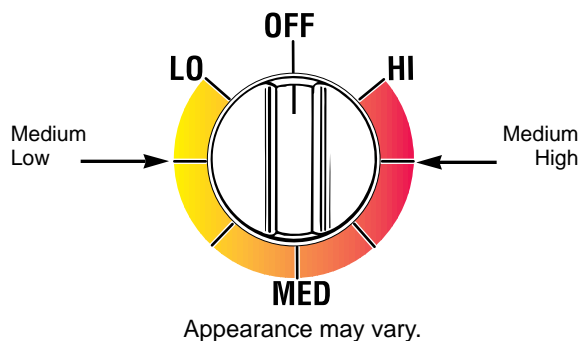

Special Notes for Glass Cooktops:

Cooktop temperatures increase with the number of surface units that are on. With 3 or 4 units turned on, surface temperatures are high so be careful when touching the cooktop. The hot surface indicator light will remain lit after the surface unit is off until the surface is cool enough to touch.

NOTE:

- At HI and Medium High settings never leave food unattended. Boilovers cause smoking and greasy spillovers may catch fire.
- At Medium Low and LO settings melt chocolate and butter on a small surface unit.

- When a surface unit is turned on, the unit can be seen glowing red within a few seconds. The red glow will turn on and off (cycling) to maintain the selected heat setting. With poor cookware, you will see frequent cycling of the unit off and on. Good, flat cookware will minimize the cycling. See the Surface Cookware Tips section.
- It is safe to place hot cookware from the oven or surface on the glass surface when it is cool.

SURFACE COOKWARE TIPS



Types of Cookware

The following information will help you choose cookware which will give good performance.

Stainless Steel: *highly recommended*

Especially good with a sandwich clad bottom. The sandwich bottom combines the benefits of stainless steel (appearance, durability and stability) with the advantages of aluminum or copper (heat conduction, even heat distribution).

Aluminum: *heavy weight recommended*

Good conductivity. Aluminum residues sometimes appear as scratches on the cooktop, but can be removed if cleaned immediately. Because of its low melting point, thin weight aluminum should not be used.

Cast Iron: *usable, but not recommended*

Poor performance. May scratch the surface.

Copper Bottom:

Good performance, but copper may leave residues which can appear as scratches. The residues can be removed, as long as the cooktop is cleaned immediately. However, do not let these pots boil dry. Overheated metal can bond to glass cooktops. An overheated copper pot will leave a residue that will permanently stain the cooktop.

Porcelain/enamel:

Good performance only with a thick, flat, smooth bottom. Avoid boiling dry, as porcelain can melt and fuse to the surface.

Glass-ceramic: *usable, but not recommended*

Poor performance. May scratch the surface.

Stoneware: *usable, but not recommended*

Poor performance. May scratch the surface.

- Place only dry pans on the surface units. Do not place lids on the surface units, particularly wet lids.

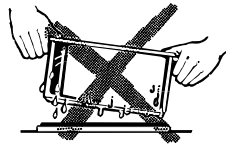

- We recommend that you use only a flat-bottomed wok. They are available at your local retail store. The bottom of the wok should have the same diameter as the surface unit to insure proper contact.



- Do not use woks that have support rings. This type of wok will not heat on glass cooktops.



- Some special cooking procedures require specific cookware such as pressure cookers, deep fat fryers, etc. All cookware must have flat bottoms and be the correct size.

(continued next page)



SURFACE COOKWARE TIPS

(continued)

How to Check Pan Performance

Use of correct cookware can affect the cooking performance and cleaning of your cooktop.

The correct cookware reduces the temperature of the cooktop surface and minimizes the chance of spillovers burning onto the cooktop.

You must use pans with perfectly flat bottoms.

Some pans may have curved or rounded bottoms or may be warped. If you are unsure of the flatness of your pans you may do this quick test.

Turn your pan upside down on the countertop, place a ruler flat against the pan surface. The bottom of the pan and the straight edge of the ruler should fit flush against each other all the way across. Turn the ruler a full 360 degrees, checking for any space between the ruler and the bottom of the pan.

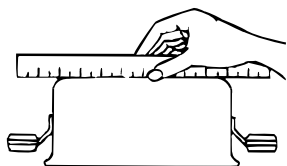

Pans with rounded, curved, ridged or warped bottoms are not recommended.

Another simple test to determine even heat distribution across the cookware bottom is to put one inch of water in the pan. Bring the water to a boil and observe the location of bubbles as the water starts to boil. Good flat cookware will have an even distribution of bubbles over the bottom surface area of the pan. Bubbles localized in only a portion of the bottom indicate uneven contact of the pan to the surface unit, uneven heat transfer or an unsuitable pan.

Use pans that match the diameter of the surface unit. Cooking performance will not be as good if the cookware is either smaller or larger than the surface unit.

SPECIAL CAUTIONS FOR GLASS COOKTOPS



- Never cook directly on the glass. Always use cookware.



- Do not slide cookware across the cooktop because it can scratch the glass—**the glass is scratch resistant, not scratch proof.**



- Always place the pan in the center of the surface unit you are cooking on.



- Don't store heavy items above the cooktop. If they drop onto the cooktop, they can cause damage.

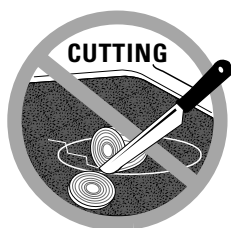

- Do not use the surface as a cutting board.

HOME CANNING TIPS

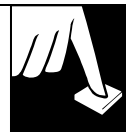

Canning should be done on the cooktop only.

Pots that extend beyond 1 inch of the surface unit circle are not recommended for most surface cooking. However, when canning with water-bath or pressure canner, larger-diameter pots may be used. This is because boiling water temperatures (even under pressure) are not harmful to the cooktop surfaces surrounding the surface units.

HOWEVER, DO NOT USE LARGE DIAMETER CANNERS OR OTHER LARGE DIAMETER POTS FOR FRYING OR BOILING FOODS OTHER THAN WATER. Most syrup or sauce mixtures—and all types of frying—cook at temperatures much higher than boiling water. Such temperatures could eventually harm the glass cooktop surfaces.

Observe the Following Points in Canning

1. Be sure the canner fits over the center of the surface unit. If your cooktop or its location does not allow the canner to be centered on the surface unit, use smaller diameter pots for good canning results.
2. Flat-bottomed canners must be used. Do not use canners with flanged or rippled bottoms (often found in enamelware) because they don't make enough contact with the surface units and take too long to boil water.

RIGHT



WRONG

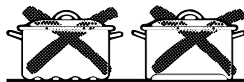

Flat-bottomed canners are required for glass cooktops.

3. When canning, use recipes and procedures from reputable sources. Reliable recipes and procedures are available from the manufacturer of your canner; manufacturers of glass jars for canning, such as Ball and Kerr; and the United States Department of Agriculture Extension Service.
4. Remember that canning is a process that generates large amounts of steam. To avoid burns from steam or heat, be careful when canning.

NOTE: If your house has low voltage, canning may take longer than expected, even though directions have been carefully followed. The process time will be shortened by:

- (1) using a pressure canner, and
- (2) starting with HOT tap water for fastest heating of large quantities of water.

CAUTION:

Safe canning requires that harmful microorganisms are destroyed and that the jars are sealed completely. When canning foods in a water-bath canner, a gentle but steady boil must be maintained for the required time. When canning foods in a pressure canner, the pressure must be maintained for the required time.

After you have adjusted the controls, it is very important to make sure the prescribed boil or pressure levels are maintained for the required time.

The cooktop surface units have temperature limiters that prevent the glass cooktop from getting too hot. If the bottom of your canner is not flat, the surface unit can overheat, triggering the temperature limiters to cycle the unit off for a time. This will stop the boil or reduce the pressure in the canner.

Since you must make sure to process the canning jars for the prescribed time, with no interruption in processing time, you cannot can on any of the cooktop surface units if your canner is not flat enough.

What is a Temperature Limiter?

Every radiant surface unit has a Temperature Limiter. The Temperature Limiter protects the glass cooktop from getting too hot.

The Temperature Limiter may cycle the units off for a time if:

- The pan boils dry.
- The pan bottom is not flat.
- The pan is off center.
- There is no pan on the unit.



GLASS COOKTOP CLEANING

Glass Cooktop Cleaning

Cleaning of glass cooktops is different from cleaning a standard porcelain finish. To maintain and protect the surface of your new glass cooktop follow these basic steps.

Before you use the cooktop for the first time, clean it with cleaning cream. This helps protect the top and makes clean-up easier.

DAILY CLEANING: Use only a recommended cleaning cream, such as Cerama Brite or the Cooktop Cleaning Creme, on the glass cooktop.

For normal, light soil:

1. Rub a few drops (less is better) of the cleaning cream onto soiled area using a damp paper towel. Buff with a dry paper towel until all soil and cream are removed. Frequent cleaning leaves a protective coating which is essential in preventing scratches and abrasions.
2. Clean the surface with the cleaning cream after each use.

For heavy, burned on soil:

1. Apply a few drops of the cleaning cream to the (cool) soiled area.
2. Using a damp paper towel, rub the cream into the burned on area. As with any burned on spill, this may require some effort.
3. Carefully scrape soil with razor scraper. Hold scraper at a 30° angle against the glass cooktop.
4. If any soil remains, repeat the steps listed above. For additional protection, after all soil has been removed, polish the entire surface with the cleaning cream.
5. Buff with a dry paper towel.

NOTE:

- Using a razor scraper will not damage the surface if the 30° angle is maintained.
- Be sure to use a new, sharp razor scraper. Do not use a dull or nicked blade.
- **Store the razor scraper out of reach of children.**

SPECIAL CARE: Sugary spillovers (such as jellies, fudge, candy syrups) or **melted plastics** can cause pitting of the surface of your cooktop (not covered by the warranty) unless the spill is removed while still hot. **Special care should be taken when removing hot substances.** Follow these instructions carefully and remove soil while spill is still hot.

1. Turn off all surface units affected by the spillover. Remove hot pans.

2. Wearing an oven mitt, hold the razor scraper at a 30° angle to the cooktop and scrape hot spill to a cool area outside the surface unit.

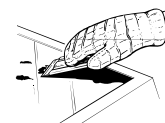

3. With the spill in a cool area, use a dry paper towel to remove any excess. Any spillover remaining should be left until the surface of the cooktop has cooled. Do not continue to use the soiled surface unit until all of the spillover has been removed. Follow the steps under Heavy Soil to continue the cleaning process.

COOKTOP SEAL: To clean the cooktop seal, let a wet cloth rest on it for a few minutes, then wipe clean. Use a mild detergent if needed. Do not use a knife or any sharp object on the seal because it will cut or damage it.

GENERAL INFORMATION: As the cleaning cream cleans, it leaves a protective coating on the cooktop surface. This coating helps to prevent build-up of mineral deposits (water spots) and will make future cleaning easier. Dishwashing detergents remove this protective coating and therefore make the cooktop more susceptible to staining.

To conveniently order more cream and/or scrapers for cleaning your glass cooktop, please call our toll free number:

National Parts Center	800-626-2002
Cleaner	# WX10X300
Scraper	# WX5X1614
Cream and scraper kit	# WB64X5027

PRECAUTIONS

- If pots with a thin overlay of aluminum, copper or enamel are allowed to boil dry, the overlay may bond with the glass cooktop and leave a black discoloration. This should be removed immediately before heating again or the discoloration may be permanent.
- Water stains (mineral deposits) are removable using the cleaning cream or full strength white vinegar.
- Use of window cleaner may leave an iridescent film on the cooktop. The cleaning cream will remove this discoloration.

- If you slide **aluminum or copper cookware** across the surface of your cooktop, they may leave **metal markings which appear as scratches**. If this should happen, use the razor scraper and cleaning cream to remove these markings. Failure to remove these residues immediately may leave permanent marks.
- Most cleaners contain ammonia, chemicals and abrasives which can damage the surface of your cooktop. **Use only the recommended cleaning cream for proper cleaning and protection of your glass cooktop.**

Read and follow all instructions and warnings on the cleaning cream labels.

FEATURES OF YOUR OVEN CONTROL

Not all features are on all models. Appearance may vary.

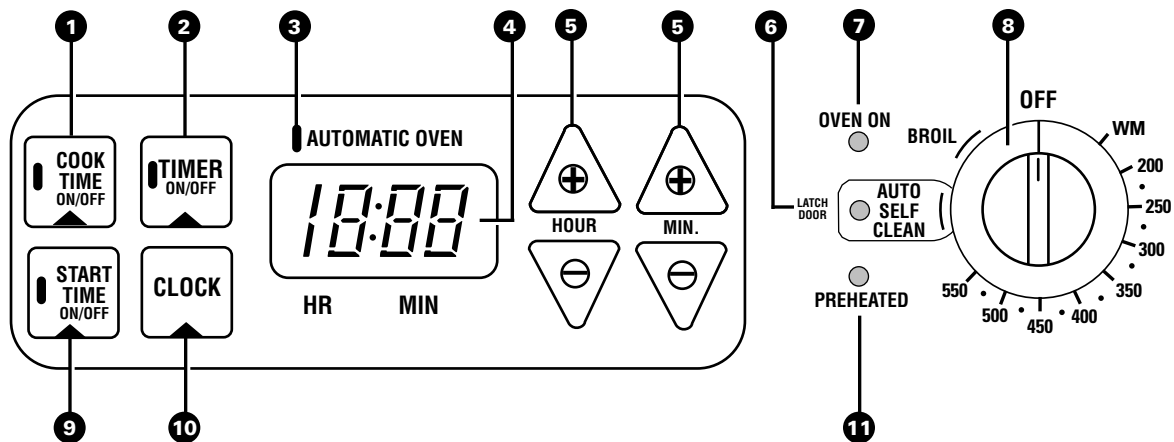

1. COOK TIME ON/OFF. Press this pad and then press the HOUR and MIN. pads to set the amount of time you want your food to cook. Turn the Oven Temperature knob to the desired temperature. The oven will shut off after the Cook Time has run out.

2. TIMER ON/OFF. Press this pad to select the timer feature. The timer does not control oven operations. The timer can time up to 11 hours and 59 minutes.

To set the timer, first press the TIMER ON/OFF pad. Press the HOUR and MIN. pads to change the time.

To cancel the timer, press the TIMER ON/OFF pad until the display clears.

3. AUTOMATIC OVEN Light. This lights anytime the oven has been programmed.

4. TIME DISPLAY. Shows the time of day and the times set for the timer on automatic oven operations.

5. HOUR and MIN. pads. These pads allow you to set times up to 11 hours and 59 minutes.

6. LATCH DOOR Light. Glows when the oven is in the Self-Clean cycle. After the Self-Clean Cycle, the light will flash. Unlatch the door and turn the Oven Temperature knob to OFF.

7. OVEN ON Light. Glows anytime the oven is heating. The light will flash when the oven automatically turns off to remind you to turn the Oven Temperature knob to OFF.

8. Oven Temperature Knob. Turn this knob to the temperature or function you want. See the Baking, Roasting, Broiling and Self-Cleaning sections.

9. START TIME ON/OFF. Press this pad and the HOUR and MIN. pads to delay the starting of your oven up to 11 hours and 59 minutes.

10. CLOCK. Press this pad before setting the clock. To set the clock, first press the CLOCK pad. Then press the HOUR and MIN. pads to change the time of day.

11. PREHEATED Indicator Light. Glows when the oven reaches your selected temperature.



OVEN CONTROL, CLOCK AND TIMER

Automatic Clock

The clock must be set for the automatic oven timing functions to work properly. The time of day cannot be changed during a Timed Baking or Self-Cleaning cycle.

To Set the Clock



1. Press the CLOCK pad.
2. Press the HOUR and MIN. pads to set the time of day.

Timer

The timer is a minute timer only. The timer does not control oven operations. The maximum setting on the timer is 11 hours and 59 minutes.

To Set the Timer



1. Press the TIMER ON/OFF pad.
2. Press the HOUR and MIN. pads until the amount of time you want shows in the display. The timer will start automatically within a few seconds of releasing the pad.

To Reset the Timer

If the display is still showing the time remaining, you may change it by pressing the HOUR and MIN. pads until the time you want appears in the display.

If the remaining time is not in the display, recall the remaining time by pressing the TIMER ON/OFF pad and then pressing the HOUR and MIN. pads until the new time you want shows on the display.

To Cancel the Timer

To cancel the timer, the remaining time must be in the display. To recall the time remaining, press the TIMER ON/OFF pad once. To cancel the timer press the TIMER ON/OFF pad again.

End of Cycle Tones (on some models)

The end of cycle tone can be cleared by pressing the TIMER ON/OFF pad or, on some models, by pressing the COOK TIME ON/OFF pad depending on which function you are using.

Power Outage

On some models, after a power outage the oven will automatically resume its setting once the power is restored.

For models with a CLOCK pad, when the power is restored the display will flash "PF" for Power Failure until a pad is pressed or the knob is turned. Reset the clock to the correct time of day.

If the oven was in operation when the power outage occurred, the Oven Temperature knob must be turned back to OFF. Then reset the knob to the way it was before the power outage.

If your model has a COOK TIME ON/OFF pad and your oven was set for timed baking or roasting when the power outage occurred, the clock and all programmed functions must be reset. To reset them, first turn the Oven Temperature knob back to OFF, reset the clock, functions and knob back to the way they were before the power outage.

Oven Temperature Knob

The oven temperature knob maintains the temperature you set from WARM (170°F.) to BROIL (550°F.). It also has an OFF and an AUTO SELF CLEAN setting.

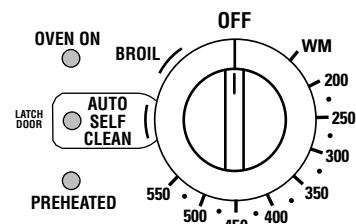

Appearance may vary.

The PREHEATED light glows when the oven reaches your selected temperature.

The OVEN ON light will glow any time the Oven Temperature knob is not in the OFF position and is set on a temperature or a function.

USING YOUR OVEN



Before Using Your Oven

1. Look at the controls. Be sure you understand how to set them properly.
2. Check the oven interior. Look at the shelves. Take a practice run at removing and replacing them properly to give sure, sturdy support.
3. Read over the information and tips that follow.
4. Keep this guide handy so you can refer to it, especially during the first weeks of using your new range.

Oven Shelves

The shelves are designed with stop-locks so that when placed correctly on the shelf supports, they will stop before coming completely out from the oven, and will not tilt when removing food from or placing food on them.

When placing cookware on a shelf, pull the shelf out to the bump on the shelf support. Place the cookware on the shelf, then slide the shelf back into the oven. This will eliminate reaching into the hot oven.

To remove a shelf from the oven, pull it toward you, tilt the front end upward and pull it out.

To replace, place the shelf on the shelf support with the stop-locks (curved extension of the shelf) facing up toward the rear of the oven. Tilt up the front and push the shelf toward the back of the oven until it goes past the bump on the shelf support. Then lower the front of the shelf and push it all the way back.

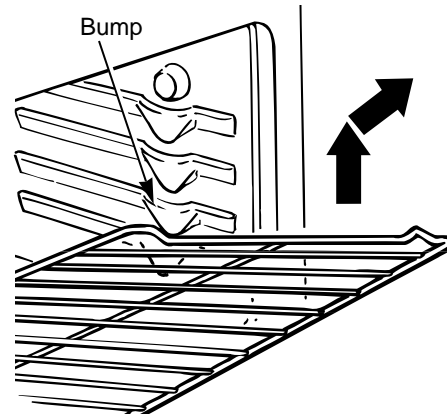

Shelf Positions

The oven has 4 shelf supports as identified in this illustration as A (bottom), B, C and D (top).

Shelf positions for cooking food are suggested in the Baking, Roasting and Broiling sections.

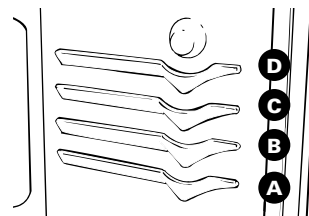

Oven Light

The light comes on automatically when the oven door is opened.

On some models, use the switch to turn the light on and off when the door is closed.

OVEN
LIGHT



(on some models)

Automatic Oven Shut-Off

As a safety feature, this oven will automatically shut itself off if it has been left on for more than 12 hours.



BAKING

Do not lock the oven door with the latch during baking. The latch is used for self-cleaning only.

Your oven temperature is controlled very accurately using an oven control system. We recommend that you operate the range for a number of weeks using the time given on recipes as a guide to become familiar with your new oven's performance.

If you think an adjustment is necessary, see the Adjust the Oven Thermostat section. It gives easy *Do It Yourself* instructions on how to adjust the thermostat.

NOTE: When the oven is hot, the top and outside surfaces of the range get hot too.

How to Set Your Range for Baking

To avoid possible burns, place the shelves in the correct position before you turn the oven on.

1. Turn the Oven Temperature knob to the temperature you desire.

2. Check food for doneness at minimum time on recipe. Cook longer if necessary.

3. Turn the Oven Temperature knob to OFF and then remove the foods.

Oven Shelves

Arrange the oven shelf or shelves in the desired locations while the oven is cool. The correct shelf position depends on the kind of food and the browning desired. As a general rule, place most foods in the middle of the oven, on either shelf position B or C. See the chart for suggested shelf positions. B will be used more than C.

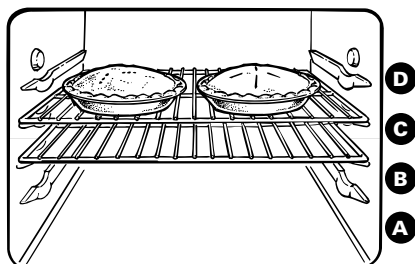

Type of Food	Shelf Position
Angel food cake	A
Biscuits or muffins	B or C
Cookies or cupcakes	B or C
Brownies	B or C
Layer cakes	B or C
Bundt or pound cakes	A or B
Pies or pie shells	B or C
Frozen pies	A (on cookie sheet)
Casseroles	B or C
Roasting	A or B

Preheating

Preheat the oven if the recipe calls for it. Preheat means bringing the oven up to the specified temperature before putting the food in the oven. To preheat, set the oven at the correct temperature—selecting a higher temperature does not shorten preheat time.

Preheating is necessary for good results when baking cakes, cookies, pastry and breads. For most casseroles and roasts, preheating is not necessary. For ovens without a preheat indicator light or tone, preheat 10 minutes. After the oven is preheated, place the food in the oven as quickly as possible to prevent heat from escaping.

Baking Pans

Use the proper baking pan. The type of finish on the pan determines the amount of browning that will occur.

- Dark, rough or dull pans absorb heat resulting in a browner, crisper crust. Use this type for pies.
- Shiny, bright and smooth pans reflect heat, resulting in a lighter, more delicate browning. Cakes and cookies require this type of pan.
- Glass baking dishes also absorb heat. When baking in glass baking dishes, the temperature may need to be reduced by 25°F.

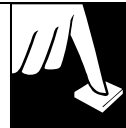

Pan Placement

For even cooking and proper browning, there must be enough room for air circulation in the oven. Baking results will be better if baking pans are centered as much as possible rather than being placed to the front or to the back of the oven.

Pans should not touch each other or the walls of the oven. Allow 1- to 1½-inch space between pans as well as from the back of the oven, the door and the sides. If you need to use two shelves, stagger the pans so one is not directly above the other.

Baking Guides

When using prepared baking mixes, follow package recipe or instructions for the best baking results.

Cookies

When baking cookies, flat cookie sheets (without sides) produce better-looking cookies. Cookies baked in a jelly roll pan (short sides all around) may have darker edges and pale or light browning may occur.

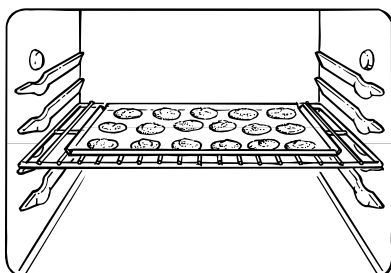

Do not use a cookie sheet so large that it touches the walls or the door of the oven. Never entirely cover a shelf with a large cookie sheet.

For best results, use only one cookie sheet in the oven at a time.

Aluminum Foil

Never entirely cover a shelf with aluminum foil. This will disturb the heat circulation and result in poor baking. A smaller sheet of foil may be used to catch a spillover by placing it on a lower shelf several inches below the food.

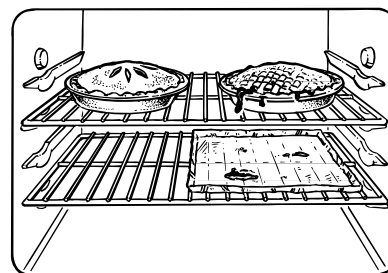

Pies

For best results, bake pies in dark, rough or dull pans to produce a browner, crisper crust. Frozen pies in foil pans should be placed on an aluminum cookie sheet for baking since the shiny foil pan reflects heat away from the pie crust; the cookie sheet helps retain it.

Cakes

When baking cakes, warped or bent pans will cause uneven baking results and poorly shaped products. A cake baked in a pan larger than the recipe recommends will usually be crisper, thinner and drier than it should be. If baked in a pan smaller than recommended, it may be undercooked and batter may overflow. Check the recipe to make sure the pan size used is the one recommended.

Don't Peek

Set the timer for the estimated cooking time and do not open the door to look at your food. Most recipes provide minimum and maximum baking times such as "bake 30-40 minutes."

DO NOT open the door to check until the minimum time. Take advantage of the "Big View" window (on some models) to monitor cooking progress. Opening the oven door frequently during cooking allows heat to escape and makes baking times longer. Your baking results may also be affected.



TIMED BAKING

(on some models)

How to Time Bake

Do not lock the oven door with the latch during timed baking. The latch is used for self-cleaning only.

The oven control allows you to turn the oven on or off automatically at specific times that you set. Examples of Immediate Start (oven turns on now and you set it to turn off automatically) and Delay Start and Stop (setting the oven to turn on automatically at a later time and turn off at a preset Stop Time) will be described.

NOTE: Before beginning, make sure the oven clock shows the correct time of day.



To set the clock, first press the CLOCK pad. Then press the HOUR and MIN. pads until the correct time of day is displayed.

How to Set Immediate Start and Automatic Stop

To avoid possible burns, place the shelves in the correct position before you turn the oven on.

The oven will turn on immediately and cook for a selected length of time. At the end of Cook Time the oven will turn off automatically.



1. Press the COOK TIME ON/OFF pad.



2. Press the HOUR and MIN. pads until the desired length of baking time appears in the display.



3. Turn the Oven Temperature knob to the desired temperature.
4. The oven will turn on. The display will show the Cook Time remaining. When the oven reaches the set temperature, a tone sounds. The oven will continue to cook for the programmed amount of time, then shut off automatically.
5. When the oven automatically turns off the AUTOMATIC OVEN light will flash and the oven will signal. Turn the oven control to OFF to stop the flashes and signal.
6. Remove the food from the oven. Remember, foods that are left in the oven continue cooking after the controls are off.

NOTE: Foods that spoil easily such as milk, eggs, fish, stuffings, poultry and pork should not be allowed to sit for more than 1 hour before or after cooking. Room temperature promotes the growth of harmful bacteria. Be sure that the oven light is off because heat from the bulb will speed harmful bacteria growth.

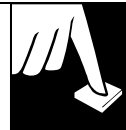

How to Set Delay Start and Automatic Stop

Quick Reminder:

1. Press the COOK TIME ON/OFF pad.
2. Press the HOUR and MIN. pads to set the desired length of cooking time.
3. Press the START TIME ON/OFF pad.
4. Press the HOUR and MIN. pads to set the time of day you want cooking to start.
5. Turn the Oven Temperature knob to the desired temperature.

To avoid possible burns, place the shelves in the correct position before you program the oven.

You can set the oven control to delay-start the oven, cook for a specific length of time and then turn off automatically.

For example: Let's say it's 2:00 and dinner time is shortly after 7:00. The recipe suggests 3 hours cooking time at 325°F.



1. Press the COOK TIME ON/OFF pad.



2. For 3 hours of cooking time, press the HOUR pad until "3:00" appears in the display.



3. Press the START TIME ON/OFF pad.

4. Press the HOUR pad until "4:00" appears in the display. The timer is now set to start baking in 2 hours, at 4:00.
5. Turn the Oven Temperature knob to the desired temperature (in this example 325°F).
The oven is now set to start at 4:00 and cook for 3 hours at a temperature of 325°F. At the end of the 3 hour cooking time (7:00), the oven will automatically turn off. When the oven automatically turns off the AUTOMATIC OVEN light will flash and the oven will signal. Turn the oven control to OFF to stop the flashes and signal.
6. Remove the food from the oven. Remember, even though the oven shuts off automatically, foods continue cooking after controls are off.

NOTE:

- The low temperature zone of this range (between WARM and 200°F.) is available to keep hot cooked foods warm. Food kept in the oven longer than two hours at these low temperatures may spoil.
- Foods that spoil easily such as milk, eggs, fish, stuffings, poultry and pork should not be allowed to sit for more than one hour before or after cooking. Room temperature promotes the growth of harmful bacteria. Be sure that the oven light is off because heat from the bulb will speed harmful bacteria growth.

Questions and Answers

Q. Can I use the minute timer during oven cooking?

A. The minute timer can be used during any cooking function.

Q. Can I change the time of day on the clock while I'm Time Baking in the oven?

A. The time of day on the clock should not be changed during any program that uses the oven timer. You must either stop those programs or wait until they are finished before changing the time.



ADJUST THE OVEN THERMOSTAT— *DO IT YOURSELF!*

You may find that your new oven cooks differently than the one it replaced. We recommend that you use your new oven for a few weeks to become more familiar with it, following the times given in your recipes as a guide.

If you think your new oven is too hot or too cold, you can adjust the thermostat yourself. If you think it is too hot, adjust the thermostat to make it cooler. If you think it is too cool, adjust the thermostat to make it hotter.

We do not recommend the use of inexpensive thermometers, such as those found in grocery stores, to check the temperature setting of your new oven. These thermometers may vary 20–40 degrees.

To Adjust the Thermostat:

1. Put the Oven Temperature knob in the OFF position.



2. Press and hold the HOUR INCREASE and the HOUR DECREASE pads for 5 seconds until the display changes.

3. Immediately, before display changes back, press the HOUR INCREASE or DECREASE pads to increase or decrease the temperature in 5 degree increments.

The oven temperature can be increased up to 35°F. hotter or decreased 35°F. cooler.

If the oven adjustment is set cooler than the factory setting a minus sign “-” and the offset temperature will appear in the display.

4. Wait several seconds for the control to automatically set and return to its previous setting.

NOTE: This adjustment will not affect the broiling or the self-cleaning temperatures. The adjustment will be retained in memory after a power failure.

To Adjust the Temperature on Models with Only an Oven Temperature Knob

1. Put the knob in the OFF position.
2. Pull the knob off by pulling straight out.
3. Press and hold the HOTTER or COOLER button for 5 seconds to make the oven 20°F. hotter or 20°F. cooler.

When you are adjusting the thermostat, the following lights will flash indicating where the thermostat will be set when you release the adjustment button:

OVEN ON indicates the thermostat will be set at the factory setting.

PREHEATED indicates the thermostat will be set 20°F. hotter.

LATCH DOOR indicates the thermostat will be set 20°F. cooler.

4. After you have made the adjustment, replace the knob.

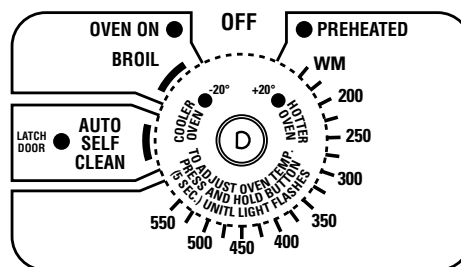
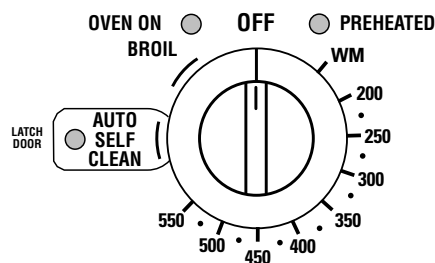

(appearance may vary)

ROASTING



Do not lock the oven door with the latch during roasting. The latch is used for self-cleaning only.

Roasting is cooking by dry heat. Tender meat or poultry can be roasted uncovered in your oven. Roasting temperatures, which should be low and steady, keep spattering to a minimum.

Roasting is really a baking procedure used for meats. Therefore, the oven controls are set for Baking or Timed Baking. (You may hear a light clicking sound, indicating the oven is working properly.) Timed Baking will turn the oven on and off automatically.

Most meats continue to cook slightly while standing, after being removed from the oven. Standing time recommended for roasts is 10 to 20 minutes. This allows roasts to firm up and makes them easier to carve. Internal temperature will rise about 5° to 10°F; to compensate for temperature increase, if desired, remove the roast from the oven sooner (at 5° to 10°F less than the temperature in the Roasting Guide).

Remember that food will continue to cook in the hot oven and therefore should be removed when the desired internal temperature has been reached.

1. Place the shelf in A or B position. No preheating is necessary.
2. Check the weight of the meat. Place it, fat side up, or for poultry, breast-side-up, on the roasting grid in a shallow pan. The melting fat will baste the meat. Select a pan as close to the size of the meat as possible. (The broiler pan with grid is a good pan for this.)

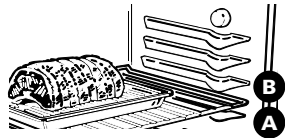

3. Turn the Oven Temperature knob to the desired setting.
4. After roasting is complete, turn the Oven Temperature knob to OFF and then remove the food from the oven.

Use of Aluminum Foil

You can use aluminum foil to line the broiler pan. This makes clean-up easier when using the pan for marinating, cooking with fruits, cooking heavily cured meats or basting food during cooking. Press the foil tightly around the inside of the pan.



(continued next page)



ROASTING

(continued)

Questions and Answers

Q. Is it necessary to check for doneness with a meat thermometer?

A. Checking the finished internal temperature at the completion of cooking time is recommended. Temperatures are shown in the Roasting Guide. For roasts over 8 lbs., check with thermometer at half-hour intervals after half the cooking time has passed.

Q. Why is my roast crumbling when I try to carve it?

A. Roasts are easier to slice if allowed to cool 10 to 20 minutes after removing them from the oven. Be sure to cut across the grain of the meat.

Q. Do I need to preheat my oven each time I cook a roast or poultry?

A. It is not necessary to preheat your oven.

Q. When buying a roast, are there any special tips that would help me cook it more evenly?

A. Yes. Buy a roast as even in thickness as possible, or buy rolled roasts.

Q. Can I seal the sides of my foil “tent” when roasting a turkey?

A. Sealing the foil will steam the meat. Leaving it unsealed allows the air to circulate and brown the meat.

ROASTING GUIDE

Frozen Roasts

Frozen roasts of beef, pork, lamb, etc., can be started without thawing, but allow 10 to 25 minutes per pound additional time (10 minutes per pound for roasts under 5 pounds, more time for larger roasts).

Make sure poultry is thawed before roasting. Unthawed poultry often does not cook evenly. Some commercial frozen poultry can be cooked successfully without thawing. Follow the directions given on the package label.

Type	Oven Temperature	Doneness	Approximate Roasting Time in Minutes per Pound		Internal Temperature °F.
Meat			3 to 5 lbs.	6 to 8 lbs.	
Tender cuts; rib, high quality sirloin tip, rump or top round*	325°	Rare: Medium: Well Done:	24–33 35–39 40–45	18–22 22–29 30–35	140°–150°† 150°–160° 170°–185°
Lamb leg or bone-in shoulder*	325°	Rare: Medium: Well Done:	21–25 25–30 30–35	20–23 24–28 28–33	140°–150°† 150°–160° 170°–185°
Veal shoulder, leg or loin*	325°	Well Done:	35–45	30–40	170°–180°
Pork loin, rib or shoulder*	325°	Well Done:	35–45	30–40	170°–180°
Ham, precooked	325°	To Warm:	17–20 minutes per pound (any weight)		115°–120°
Poultry			3 to 5 lbs.	Over 5 lbs.	
Chicken or Duck	325°	Well Done:	35–40	30–35	185°–190°
Chicken pieces	350°	Well Done:	35–40		185°–190°
Turkey	325°	Well Done:	10 to 15 lbs. 18–25	Over 15 lbs. 15–20	In thigh: 185°–190°

*For boneless rolled roasts over 6 inches thick, add 5 to 10 minutes per pound to times given above.

†The U. S. Department of Agriculture says “Rare beef is popular, but you should know that cooking it to only 140°F. means some food poisoning organisms may survive.” (Source: *Safe Food Book. Your Kitchen Guide.* USDA Rev. June 1985.)

BROILING



Do not lock the oven door with the latch while broiling. The latch is used for self-cleaning only.

Broiling is cooking food by intense radiant heat from the upper broil element in the oven. Most fish and tender cuts of meat can be broiled. Follow these directions to keep spattering and smoking to a minimum.

Turn the food only once during broiling. Time the foods for the first side according to the Broiling Guide.

Turn the food, then use the times given for the second side as a guide to the preferred doneness.

1. If the meat has fat or gristle around the edge, cut vertical slashes through both about 2 inches apart. If desired, the fat may be trimmed, leaving layer about 1/8 inch thick.
2. Place the meat on the broiler grid in the broiler pan. Always use the grid so the fat drips into the broiler pan; otherwise the juices may become hot enough to catch on fire.
3. Position a shelf on the recommended shelf position as suggested in the Broiling Guide.

4. **Leave the door open to the broil stop position.** The door stays open by itself, yet the proper temperature is maintained in the oven.

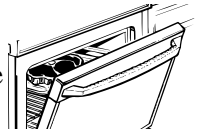

5. Turn the Oven Temperature knob to BROIL. **Make sure you turn the knob all the way to the BROIL position.**
6. Turn the food only once during broiling. Time the foods for the first side according to the Broiling Guide.
7. When broiling is finished, turn the Oven Temperature knob to OFF. Serve the food immediately, and leave the pan outside the oven to cool during the meal for easiest cleaning.

Use of Aluminum Foil

You can use aluminum foil to line your broiler pan and broiler grid. However, you must mold the foil tightly to the grid and cut slits in it just like the grid.

Without the slits, the foil will prevent fat and meat juices from draining to the broiler pan. The juices could become hot enough to catch on fire. If you do not cut the slits, you are frying, not broiling.

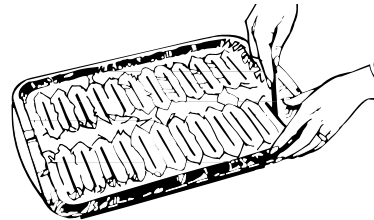

Questions and Answers

Q. When broiling, is it necessary to always use a grid in the pan?

A. Yes. Using the grid suspends the meat over the pan. As the meat cooks, the juices fall into the pan, thus keeping meat drier. Juices are protected by the grid and stay cooler, thus preventing excessive spatter and smoking.

Q. Should I salt the meat before broiling?

A. No. Salt draws out the juices and allows them to evaporate. Always salt after cooking. Turn the meat with tongs; piercing the meat with a fork also allows the juices to escape. When broiling poultry or fish, brush each side often with butter.

Q. Why are my meats not turning out as brown as they should?

A. In some areas, the power (voltage) to the range may be low. In these cases, preheat the broil element for 10 minutes before placing broiler pan with food in oven. Check to see if you are using the recommended shelf position. Broil for the longest period of time indicated in the Broiling Guide. Turn the food only once during broiling.

Q. Do I need to grease my broiler grid to prevent meat from sticking?

A. No. The broiler grid is designed to reflect broiler heat, thus keeping the surface cool enough to prevent the meat from sticking to the surface. However, spraying the broiler grid lightly with a vegetable cooking spray before cooking will make clean-up easier.



BROILING GUIDE

- Always use a broiler pan and grid. They are designed to minimize smoking and spattering by trapping juices in the shielded lower part of the pan.
- **The oven door should be open to the broil stop position.**
- **Make sure you turn the knob all the way to the BROIL position.**
- If desired, marinate meats or chicken before broiling, or brush with barbecue sauce last 5 to 10 minutes only.
- When arranging food on the pan, do not let fatty edges hang over the sides. These could soil the oven bottom.
- Frozen steaks can be broiled by positioning the oven shelf at next lowest shelf position and increasing cooking time given in this guide 1½ times per side.

Food	Quantity and/or Thickness	Shelf Position	First Side Time, Minutes	Second Side Time, Minutes	Comments
Bacon	1/2 lb. (about 8 thin slices)	C	4½	4½	Arrange in single layer.
Ground Beef Well Done	1 lb. (4 patties) 1/2 to 3/4 inch thick	C	10	7	Space evenly. Up to 8 patties take about same time.
Beef Steaks					
Rare	1 inch thick	C	6	5	Steaks less than 1 inch thick cook through before browning. Pan frying is recommended.
Medium	(1 to 1½ lbs.)	C	8	6	
Well Done		C	12	11	
Rare	1½ inch thick	C	10	7-8	Slash fat.
Medium	(2 to 2½ lbs.)	C	15	14-16	
Well Done		C	25	20-25	
Chicken	1 whole (2 to 2½ lbs.), split lengthwise	A	35	10-15	Reduce time about 5 to 10 minutes per side for cut-up chicken. Brush each side with melted butter. Broil skin-side-down first.
Bakery Products					
Bread (Toast) or Toaster Pastries	2 to 4 slices	C or D	1½-2	1/2	Space evenly. Place English muffins cut-side-up and brush with butter, if desired.
English Muffins	1 pkg. (2) 2 (split)	C or D	3-4		
Loaster Tails	2-4 (6 to 8 oz. each)	B	13-16	Do not turn over.	Cut through back of shell. Spread open. Brush with melted butter before broiling and after half of broiling time.
Fish	1-lb. fillets 1/4 to 1/2 inch thick	C	5	5	Handle and turn very carefully. Brush with lemon butter before and during cooking, if desired. Preheat broiler to increase browning.
Ham Slices (precooked)	1 inch thick	B	8	8	Increase time 5 to 10 minutes per side for 1½ inch thick or home cured ham.
Pork Chops Well Done	2 (1/2 inch thick) 2 (1 inch thick), about 1 lb.	C B	10 13	10 13	Slash fat.
Lamb Chops					
Medium	2 (1 inch thick),	C	10	9	Slash fat.
Well Done	about 10 to 12 oz.	C	12	10	
Medium	2 (1½ inch thick),	C	14	12	
Well Done	about 1 lb.	B	17	12-14	
Wieners and similar precooked sausages, bratwurst	1-lb. pkg. (10)	C	6	1-2	If desired, split sausages in half lengthwise; cut into 5- to 6-inch pieces.

OPERATING THE SELF-CLEANING OVEN

Total Cleaning Cycle Time: 4 hours and 20 minutes



Quick Reminder:

1. Latch the door.
2. Turn the Oven Temperature knob to AUTO SELF CLEAN.

Before a Clean Cycle

The range must be completely cool in order to set the self-clean cycle. You may have to allow the oven to cool before you can slide the door latch.

We recommend venting with an open window or using a ventilation fan or hood during the first self-clean cycle.

1. Remove all cookware and any aluminum foil from the oven—they cannot withstand the high cleaning temperatures.

NOTE: The oven shelves may be cleaned in the self-cleaning oven. However, they will darken, lose their luster and become hard to slide.

2. To avoid heavy smoke in the kitchen during self-cleaning, wipe up heavy soil on the oven bottom. (If you use soap, rinse thoroughly before self-cleaning to prevent staining.) The enamel grid and broiler pan may be cleaned in the self-cleaning oven. However, to help prevent heavy smoke caused by self-cleaning the greasy soil in the pan, you must first clean off the excess grease.

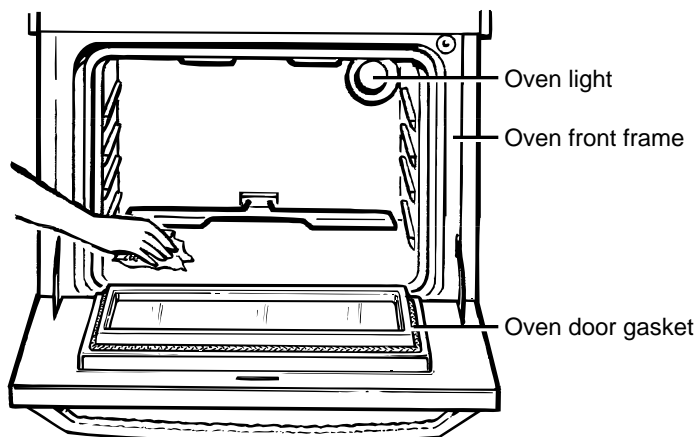

3. Clean spatters or spills on the oven front frame, and the oven door outside the gasket with a dampened cloth. The oven front frame and the oven door outside the gasket do not get cleaned by the self-clean cycle. On these areas use detergent and hot water or a soap-filled steel wool pad. Rinse well with a vinegar and water solution. This will help prevent a brown residue from forming when the oven is heated. Buff these areas with a dry cloth. Do not clean the gasket.

Do not use abrasives or oven cleaners. Clean the top, sides and outside front of the oven door with soap and water.

Make sure the oven light bulb cover is in place.

Do not rub or clean the door gasket—the fiberglass material of the gasket has an extremely low resistance to abrasion. An intact and well-fitting oven door gasket is essential for energy-efficient oven operation and good baking results. If you notice the gasket becoming worn, frayed or damaged in any way or if it has become displaced on the door, you should have it replaced.

4. Close the door and make sure the oven light is off. If the oven light is not turned off, the life of the bulb will be shortened or it may burn out immediately.

Do not use commercial oven cleaners or oven protectors in or near the self-cleaning oven.

A combination of any of these products plus the high clean cycle temperatures may damage the porcelain finish of the oven.

(continued next page)



OPERATING THE SELF-CLEANING OVEN

(continued)

How to Set the Oven for Cleaning

Quick Reminder:

1. Latch the door.
2. Turn the Oven Temperature knob to AUTO SELF CLEAN.

If the oven is too hot and you start to set a clean cycle, you will not be able to slide the latch.

Allow additional time for cooling before you try to set the cycle.

1. Follow directions to prepare the oven for cleaning.
2. Slide the latch handle to the right as far as it will go.

Never force the latch handle. Forcing the handle will damage the door lock mechanism.

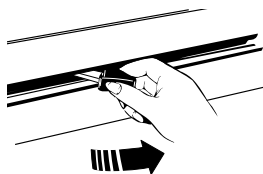

3. Turn the Oven Temperature knob to AUTO SELF CLEAN. The AUTO SELF CLEAN, AUTOMATIC OVEN, OVEN ON and COOK TIME ON/OFF lights will glow.

NOTE: If you turn the Oven Temperature knob before you slide the latch, the LATCH DOOR light will flash. Slide the latch to the right.

Clean cycle time is normally 4 hours and 20 minutes. On all models except JBP65, you can change the clean time to anywhere between 3 hours and 5 hours, and 59 minutes, depending on how dirty your oven is.

You have one minute to change your clean time. Use the HOUR and MIN. pads to change the total clean time.

Both the OVEN ON light and the LATCH DOOR light will flash when the clean time is finished.

After using the clean cycle, the door latch and the Oven Temperature knob must be returned to their original positions before you can use the oven.

When the LATCH DOOR light flashes, slide the latch handle to the left as far as it will go, turn the Oven Temperature knob to OFF and open the door.

Never force the latch handle. Wait until the LATCH DOOR light flashes and the latch slides easily. Forcing the latch handle may damage the door lock.

To Stop A Clean Cycle

1. Turn the Oven Temperature knob to OFF.
2. Wait until the oven has cooled below the locking temperature to unlatch the door. You will not be able to open the door right away unless the oven has cooled below the locking temperature.

After a Clean Cycle

You may notice some white ash in the oven. Just wipe it up with a damp cloth after the oven cools.

If white spots remain, remove them with a soap-filled steel wool pad. Be sure to rinse thoroughly with a vinegar and water mixture. These deposits are usually a salt residue that cannot be removed by the Clean Cycle.

If the oven is not clean after one Clean Cycle, repeat the cycle.

NOTE:

- You cannot set the oven for cooking until the oven is cool enough for the door to be unlatched.
- While the oven is self-cleaning, you can press the CLOCK pad to display the time of day. To return to the clean count down, press the COOK TIME ON/OFF pad.
- If the shelves become hard to slide, wipe the shelf supports with cooking oil.

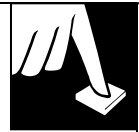

How to Set Delay Start of Cleaning (on some models)

Quick Reminder:

1. Latch the door.
2. Turn the Oven Temperature Control knob to AUTO SELF CLEAN.
3. Press the START TIME ON/OFF pad.
4. Press the HOUR and MIN. pads to set the time of day you want cleaning to start. The Self-Clean Cycle will automatically begin at the time you selected.

Delay Start is setting the oven timer to start the clean cycle automatically at a later time than the present time of day.

For example: Let's say it is 7:00 and you want the oven to begin self-cleaning at 9:00 after you're finished in the kitchen. The oven is just soiled a normal amount so the normal Clean Time of 4 hours and 20 minutes is preferred.

1. Follow steps to prepare the oven for cleaning.

2. Slide the latch handle to the right as far as it will go.

Never force the latch handle. Forcing the handle will damage the door lock mechanism.

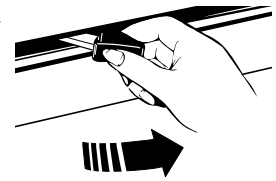

3. Turn the Oven Temperature knob to the AUTO SELF CLEAN position.
4. Press the START TIME ON/OFF pad.
5. Press the HOUR pad until 9:00 appears in the display. The timer is now set to start cleaning in 2 hours, at 9:00.

The Self-Clean Cycle will be set to automatically begin at 9:00 and finish at 1:20.

Both the Oven On light and the Latch Door light will flash when the Clean Time is finished.

6. When the Latch Door light flashes, slide the latch handle to the left as far as it will go, turn the Oven Temperature knob to OFF and open the door.

Never force the latch handle. Wait until the Latch Door light flashes and the latch slides easily. Forcing the latch handle may damage the door lock.

Questions and Answers

Q. Can I use commercial oven cleaners on any part of my self-cleaning oven?

- A. No cleaners or coatings should be used around any part of this oven. If you do use them and do not thoroughly rinse the oven with water, wiping it absolutely clean afterwards, the residue can scar the oven surface and damage metal parts the next time the oven is automatically cleaned.

Q. What should I do if excessive smoking occurs during cleaning?

- A. This is caused by excessive soil. Turn the Oven Temperature knob to OFF. Open the windows to rid room of smoke. Wait until the LATCH DOOR light goes off. Wipe up the excess soil and reset the clean cycle.

Q. Is the "crackling" or "popping" sound I hear during cleaning normal?

- A. Yes. This is the sound of the metal heating and cooling during both the cooking and cleaning functions.

Q. Should there be any odor during the cleaning?

- A. Yes, there will be an odor during the first few cleanings. Failure to wipe out excessive soil might also cause a strong odor when cleaning.

Q. Why do I have ash left in my oven after cleaning?

- A. Some types of soil will leave a deposit which is ash. It can be removed with a damp sponge or cloth.

Q. What causes the hair-like lines on the enameled surface of my oven?

- A. This is a normal condition, resulting from heating and cooling during cleaning. These lines do not affect how your oven performs.

Q. My oven shelves do not slide easily. What is the matter?

- A. The self-clean cycle causes the oven shelves to lose their luster and become hard to slide. To make shelves slide more easily, wipe the shelf supports with cooking oil.

Q. My oven shelves have become gray after the self-clean cycle. Is this normal?

- A. Yes. After the self-clean cycle, the shelves will lose some luster and change to a deep gray color.

Q. Can I cook food on the cooktop while the oven is self-cleaning?

- A. Yes. While the oven is self-cleaning, you can use the cooktop just as you normally do.

Q. The LATCH DOOR light flashes when I set the clean cycle. What's wrong?

- A. The LATCH DOOR light will flash until the latch is moved to the right.



CARE AND CLEANING

Proper care and cleaning are important so your range will give you efficient and satisfactory service. Follow these directions carefully in caring for it to help assure safe and proper maintenance.

BE SURE ELECTRIC POWER IS OFF BEFORE CLEANING ANY PART OF THE RANGE.

▲ If your range is removed for cleaning, servicing or any reason, be sure anti-tip device is re-engaged properly when the range is replaced. Failure to take this precaution could result in tipping of the range and cause injury.

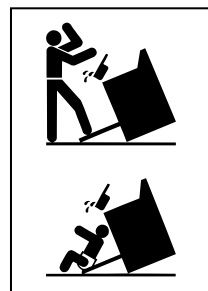

Oven Light Replacement (on some models)

CAUTION: Before replacing your oven light bulb, disconnect the electrical power to the range at the main fuse or circuit breaker panel. Be sure to let the light cover and bulb cool completely.

The oven light bulb is covered with a removable glass cover that is held in place with a bail-shaped wire. Remove the oven door, if desired, to reach cover easily.

To remove:

1. Hold a hand under the cover so it doesn't fall when released. With fingers of the same hand, firmly push back the wire cover holder. Lift off the cover.

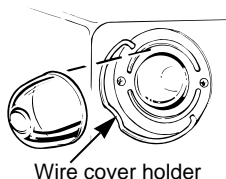

DO NOT REMOVE ANY SCREWS TO REMOVE COVER.

2. Do not touch hot bulb with a wet cloth. Replace bulb with a 40-watt household appliance bulb.

To replace cover:

1. Place it into groove of the light receptacle. Pull wire forward to the center of the cover until it snaps into place. When in place, the wire holds the cover firmly. Be certain the wire is in the depression in the center of the cover.
2. Connect electrical power to the range.

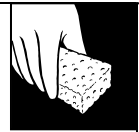

Control Panel and Knobs

Clean up any spills or splatters with a damp cloth. Remove heavier soil with warm, soapy water.

Clean the control panel with mild liquid dish detergent and a soft cloth. Rub the control panel lightly.

CAUTION: Do not use abrasives of any kind on the control panel. The lettering on models with touch pads is sensitive to abrasives and pressure.

The control knobs may be removed for easier cleaning. To remove a knob, pull it straight off the stem. Wash the knobs in soap and water but do not soak.

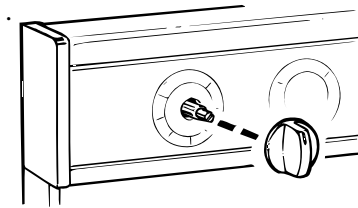

Oven Vent

The oven is vented through an opening at the rear of the cooktop. Never cover the opening with aluminum foil or any other material. This would prevent the oven vent from working properly.

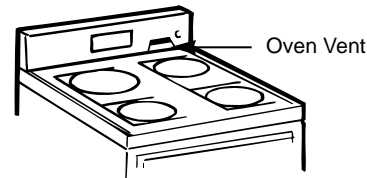

Metal Parts

Do not use steel wool, abrasives, ammonia or commercial oven cleaners. To safely clean surfaces; wash, rinse and then dry with a soft cloth.

Painted Surfaces

Painted surfaces include the sides, the control panel and the drawer or kick panel front. Clean these with soap and water or a vinegar and water solution.

Do not use commercial oven cleaners, cleansing powders, steel wool or harsh abrasives on any painted surface.

Glass Window

To clean the outside glass finish, use a glass cleaner. Rinse and polish with a dry cloth.

(continued next page)



CARE AND CLEANING

(continued)

Lift-Off Oven Door

The oven door is removable, but it is heavy. You may need help removing and replacing the door. Do not lift the door by the handle. This can cause the glass to break or can cause damage to the door.

To remove the door, open it a few inches to the special stop position that will hold the door open. Grasp firmly on each side and lift the door straight up and off the hinges.

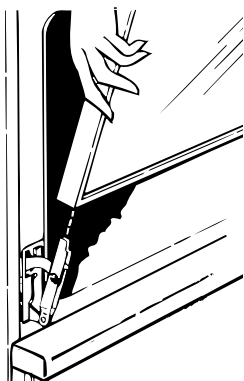

NOTE: Be careful not to place hands between the hinge and the oven door frame as the hinge could snap back and pinch fingers.

To replace the door, make sure the hinges are in the special stop position. Position the slots in the bottom of the door squarely over the hinges. Then lower the door slowly and evenly over both hinges at the same time. If hinges snap back against the oven frame, pull them back out. If the oven door is crooked, push down on the high corner to straighten it.

TO CLEAN THE DOOR:

Inside of the door:

- Because the area inside the gasket is cleaned during the self clean cycle, you do not need to clean this by hand. Any soap left on the liner causes additional stains when the oven is heated.
- The area outside the gasket can be cleaned with a scouring pad.

- Do not rub or clean the door gasket—the fiberglass material of the gasket has an extremely low resistance to abrasion. An intact and well-fitting oven door gasket is essential for energy-efficient oven operation and good baking results. If you notice the gasket becoming worn, frayed or damaged in any way or if it has become displaced on the door, you should have it replaced.

NOTE: The gasket is designed with a gap at the bottom to allow for proper air circulation.

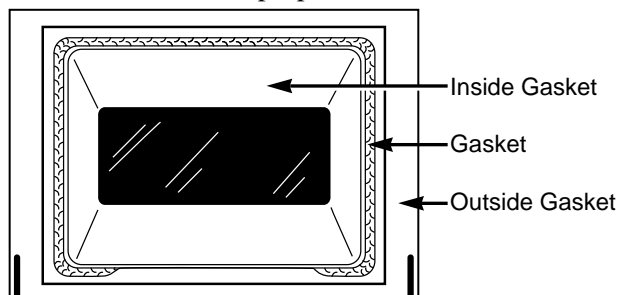

Outside of the door:

- Use soap and water to thoroughly clean the top, sides and front of the oven door. Rinse well. You may also use a glass cleaner to clean the glass on the outside of the door. To avoid water marks on the inside of the door glass, do not let water drip into the vent opening.
- Spillage of marinades, fruit juices, tomato sauces and basting materials containing acids may cause discoloration and should be wiped up immediately. When surface is cool, clean and rinse.
- Do not use oven cleaners, cleansing powders or harsh abrasives on the outside of the door.

Oven Heating Elements

Do not clean the bake element or the broil element. Any soil will burn off when the elements are heated.

The bake element can be lifted gently to clean the oven floor. If spillovers, residue or ash accumulate around the bake element gently wipe around the element with warm water.

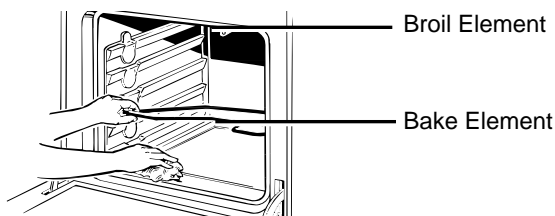

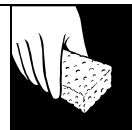

Oven Shelves

Clean the shelves with an abrasive cleanser or steel wool. After cleaning, rinse the shelves with clean water, rinse and dry.

NOTE: The oven shelves may also be cleaned in the self-cleaning oven, however, the shelves will darken in color, lose their luster and become hard to slide if cleaned during the self-cleaning cycle.

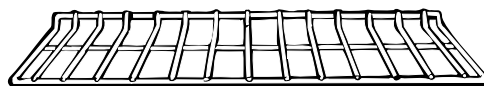

Broiler Pan and Grid

After broiling, remove the broiler pan from the oven. Remove the grid from the pan. Carefully pour out the grease from the pan into a proper container. Wash and rinse the broiler pan and grid in hot water with a soap-filled or plastic scouring pad.

The enamel grid and broiler pan may be cleaned in the self-clean oven. However, to prevent heavy smoke caused by self-cleaning the greasy soil in the pan, you must first clean off the excess grease.

If food has burned on, sprinkle the grid with detergent while hot and cover with wet paper towels or a dishcloth. Soaking the pan will remove burned-on foods.

The broiler pan may be cleaned with a commercial oven cleaner. If the grid is grey enamel, it can also be cleaned with an oven cleaner. If the grid is chrome, do not use an oven cleaner to clean it.

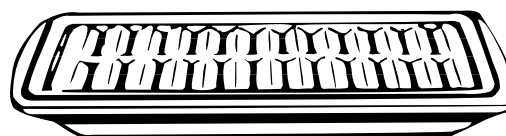

Both the broiler pan and grid can also be cleaned in the dishwasher.

Do not store a soiled broiler pan and grid anywhere in the range.

How to Remove the Storage Drawer or Kick Panel to Clean Under the Range

The area under the range can be reached easily for cleaning by removing the bottom drawer (on some models). To remove, pull the drawer out all the way, tilt up the front and remove it. To replace, insert glides at the back of the drawer beyond the stop on range glides. Lift the drawer if necessary to insert easily. Let the front of the drawer down, then push in to close.

To clean under models with a front kick panel, remove the panel by pulling it straight out at the bottom. To replace the panel, first hook the top tabs on and then the bottom tabs.

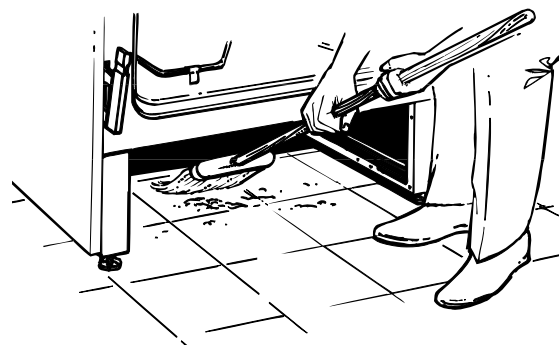



INSTALLATION INSTRUCTIONS

BEFORE YOU BEGIN

Read these instructions completely and carefully.

IMPORTANT: Save these instructions for the local electrical inspector's use.

IMPORTANT: OBSERVE ALL GOVERNING CODES AND ORDINANCES.

NOTE TO INSTALLER: Leave these instructions with the appliance after installation is completed.

NOTE TO CONSUMER: Keep this Use and Care Guide and Installation Instructions for future use.

NOTE: This appliance must be properly grounded.

TOOLS YOU WILL NEED

- Large blade screwdriver
- Channel lock pliers or small ratchet wrench with 3/16-inch socket (for leveling range)
- 1/4-inch hex head nutdriver

ELECTRICAL REQUIREMENTS

CAUTION, FOR PERSONAL SAFETY: DO NOT USE AN EXTENSION CORD WITH THIS APPLIANCE.

REMOVE HOUSE FUSE OR OPEN CIRCUIT BREAKER BEFORE BEGINNING INSTALLATION.

This appliance must be supplied with the proper voltage and frequency, and connected to an individual, properly grounded branch circuit, protected by a circuit breaker or time delay fuse, as noted on the rating plate.

Wiring must conform to National Electric Codes.

If the electric service provided does not meet the above specifications, it is recommended that a licensed electrician install an approved outlet.

Because range terminals are not accessible after range is in position, flexible service conduit or cord must be used.

STEP 1

PREPARE THE OPENING

1½ inch spacing is recommended from the range to adjacent vertical walls above cooktop surface.

Allow 30 inches minimum clearance between surface units and bottom of unprotected wood or metal top cabinet, and 15 inches minimum between countertop and adjacent cabinet bottom.

EXCEPTION: Installation of a listed microwave oven or cooking appliance over the cooktop shall conform to the installation instructions packed with that appliance.

To eliminate the risk of burns or fire by reaching over heated surface units, cabinet storage space above the surface units should be avoided. If cabinet storage is to be provided, the risk can be reduced by installing a range hood that projects horizontally a min. of 5 inches beyond the bottom of the cabinets. Make sure the wall covering, countertops and cabinets around the range can withstand heat generated by the range, oven or cooktop up to 200°F.

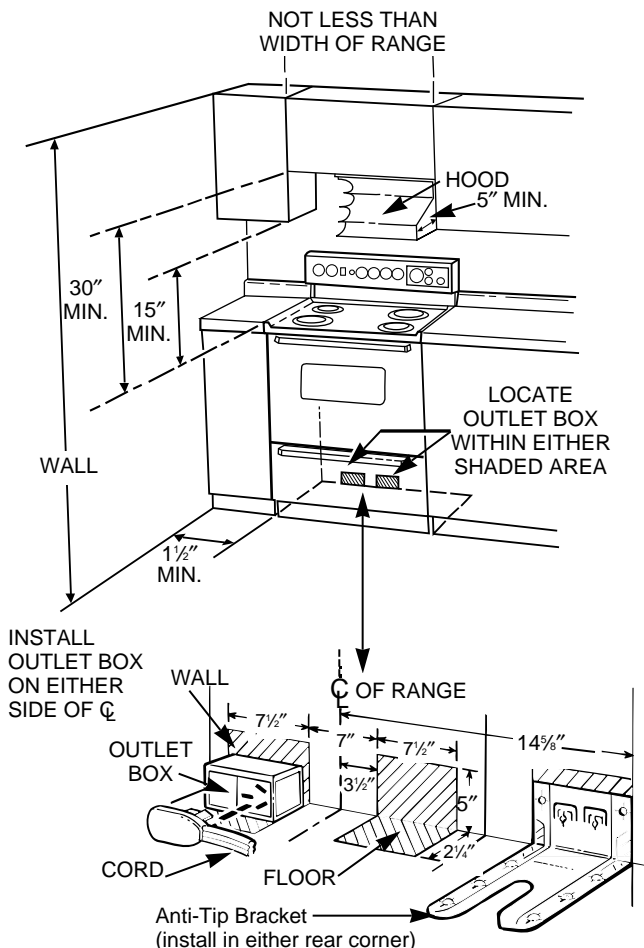

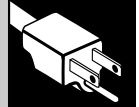

PREPARE THE OPENING (continued)

Flooring Under the Range

Your range, like many other household items, is heavy and can settle into soft floor coverings such as cushioned vinyl or carpeting. When moving the range on this type of flooring, it should be installed on a 1/4 inch thick sheet of plywood (or similar material) as follows:

When the floor covering ends at the front of the range, the area that the range will rest on should be built up with plywood to the same level or higher than the floor covering. This will allow the range to be moved for cleaning or servicing.

STEP 2

PREPARE FOR ELECTRICAL CONNECTION

Effective January 1, 1996 the National Electric Code requires that new construction (not existing) utilize a 4 conductor connection to an electric range. When installing an electric range in new construction follow Steps 3 and 5 for 4 wire connection.

Use only 3-conductor or 4-conductor U.L. listed range cord. These cords may be provided with ring terminals on wire and strain relief device.

A range cord rated at **40 amps** with 125/250 minimum volt range is required. A 50 amp range cord is not recommended but if used, it should be marked for use with nominal 1 3/8" diameter connection openings. Care should be taken to center cable and strain relief within knockout hole to keep the edge from damaging the cable.

NOTE: A 4-conductor cord is to be used when the appliance is installed in a mobile home or when local codes do not permit grounding through the neutral. If conduit is being used, go to Step 6 or 7.

STEP 3

POWER CORD STRAIN RELIEF INSTALLATION

A. Remove the lower rear range wiring cover to expose the connector block and bracket.

B. Remove the knockout ring (1 3/8") located on bracket directly below the connector. To remove the knockout, use a pair of pliers to bend the knockout ring away from the bracket and twist until ring is removed.

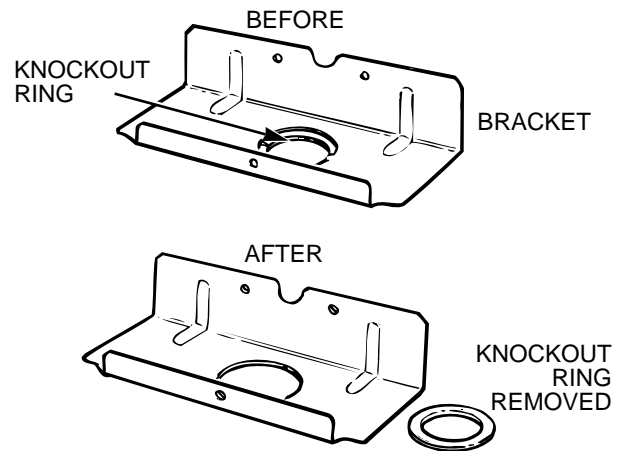

C. Assemble the strain relief in the hole. Insert the power cord through the strain relief and tighten. Allow enough slack to easily attach the cord terminals to the connector block. If tabs are present at the end of the winged strain relief, they can be removed for better fit.

NOTE: Do not install the power cord without a strain relief.

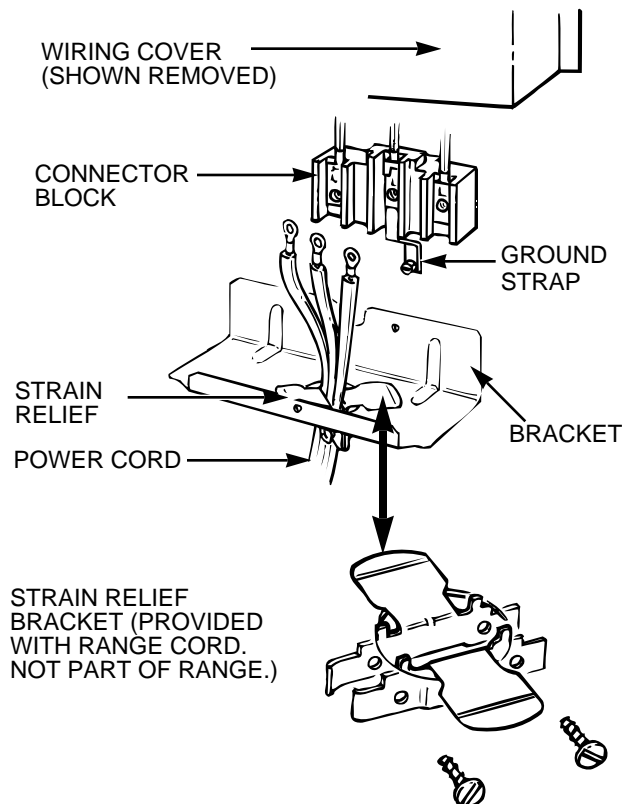

(continued next page)

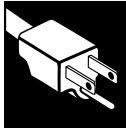

INSTALLATION INSTRUCTIONS

(continued)

STEP 4

3 WIRE POWER CORD INSTALLATION

Remove the 3 wire terminal screws from the connector block. Insert screws through each power cord terminal ring and into the connector block until the screws engage the nuts. Be certain that the center wire is connected to the center screw of the connector block. Tighten screws securely. Do NOT remove ground strap connection.

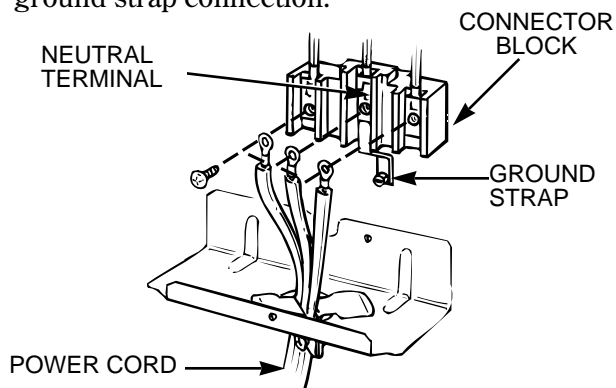

WARNING: THE NEUTRAL OR GROUND WIRE OF THE POWER CORD MUST BE CONNECTED TO THE NEUTRAL TERMINAL LOCATED IN THE CENTER OF THE CONNECTOR BLOCK. THE POWER LEADS MUST BE CONNECTED TO THE OUTSIDE (BRASS COLORED) TERMINALS.

STEP 5

4 WIRE POWER CORD INSTALLATION

A. Remove the 3 screws from the connector block.

B. Remove the grounding screw and strap from the connector block middle location and the screw connection to the frame of the range.

BEFORE

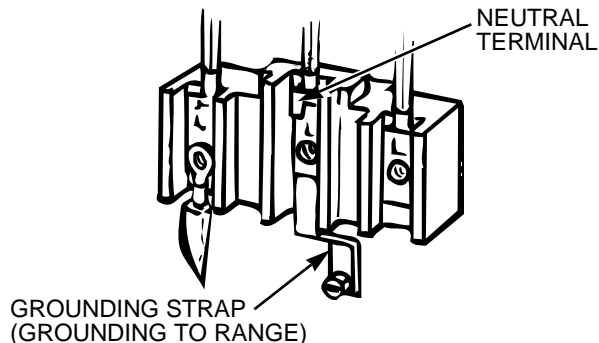

C. Insert screws through each power cord terminal ring and into connector block until screw engages nut. Be certain that the center wire is connected to the center screw of the connector block. Tighten screws securely.

D. Attach ground wire to the frame of the range.

AFTER

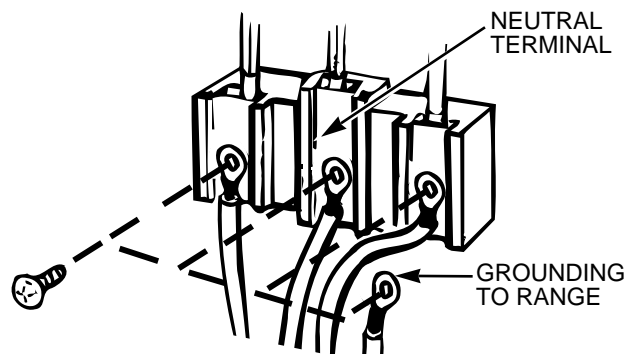

WARNING: THE NEUTRAL WIRE OF SUPPLY CIRCUIT IS CONNECTED TO THE NEUTRAL TERMINAL LOCATED IN THE CENTER OF THE CONNECTOR BLOCK. THE POWER LEADS MUST BE CONNECTED TO THE OUTSIDE (BRASS COLORED) TERMINALS. THE 4TH GROUNDING LEAD MUST BE CONNECTED TO THE FRAME OF THE RANGE WITH THE GROUNDING SCREW.



STEP 6

3 WIRE CONDUIT INSTALLATION

Remove the 3 screws from the connector block. Insert bare wires between the connector block terminals and movable nuts. Tighten screws securely. Do not remove ground strap connection.

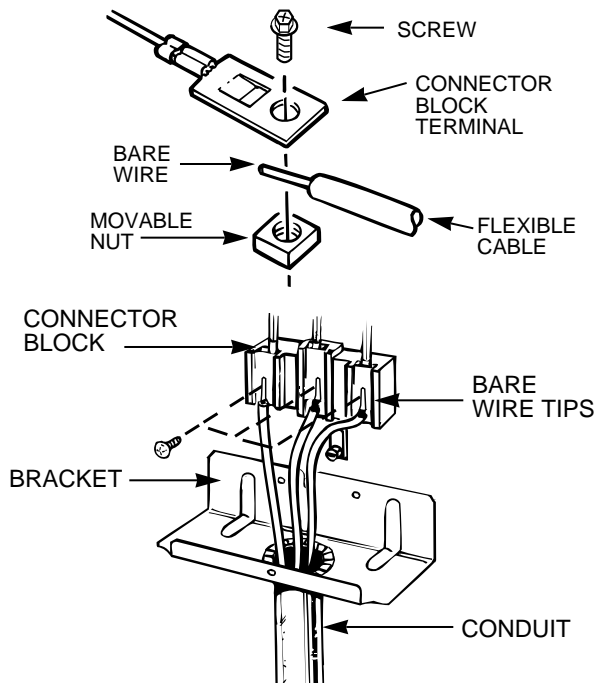

WARNING: CONNECTOR BLOCK IS APPROVED FOR COPPER WIRE CONNECTION ONLY. IF ALUMINUM WIRE IS USED, SEE NOTE BELOW.

NOTE: ALUMINUM WIRING

A. Do not connect Aluminum wire to connector block. Use copper building wire rated for the correct amperage and voltage to make 3 (three) 3 inch copper jumper wires. Connect wire as per Step 6 or 7 depending on number of wires.

B. Splice copper wires to aluminum wiring using special connector terminals designed and UL approved for joining copper to aluminum and follow the connector manufacturers recommended procedure closely.

Wire used, location and enclosure of splices, etc., must conform to good wiring practices and local codes.

STEP 7

4 WIRE CONDUIT INSTALLATION

Remove the 3 screws from the connector block. Remove the grounding strap from the connector block middle location and the screw connecting it to the frame of the range. Insert bare wires between the connector block terminals and movable nuts. Tighten screws securely. Attach ground wire to the frame of the range.

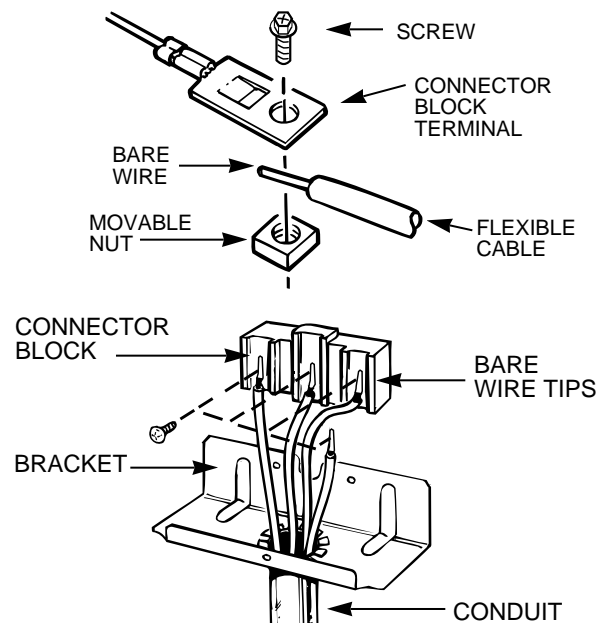

WARNING: CONNECTOR BLOCK IS APPROVED FOR COPPER WIRE CONNECTION ONLY. IF ALUMINUM WIRE IS USED, SEE NOTE BELOW.

NOTE: ALUMINUM WIRING

A. Do not connect Aluminum wire to connector block. Use copper building wire rated for the correct amperage and voltage to make 3 (three) 3 inch copper jumper wires. Connect wire as per Step 6 or 7 depending on number of wires.

B. Splice copper wires to aluminum wiring using special connector terminals designed and UL approved for joining copper to aluminum and follow the connector manufacturers recommended procedure closely.

Wire used, location and enclosure of splices, etc., must conform to good wiring practices and local codes.

(continued next page)

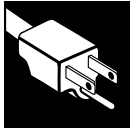

INSTALLATION INSTRUCTIONS

(continued)

STEP 8

ANTI-TIP BRACKET INSTALLATION

AN ANTI-TIP bracket is supplied with instructions for installation in a variety of locations. The instructions include a template, a parts list and a list of tools necessary to complete the installation. Read the IMPORTANT SAFETY INSTRUCTIONS and the instructions that fit your situation before beginning installation.

WARNING

1. Range must be secured by ANTI-TIP bracket supplied.
2. See instructions to install (supplied with bracket).
3. Unless properly installed, range could be tipped by stepping or sitting on door. Injury might result from spilled hot liquids or from range itself.

Typical Installation of Anti-Tip Bracket Attachment to Wall

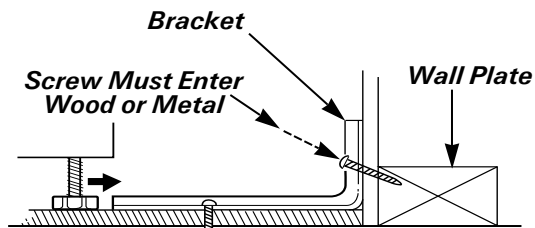

STEP 9

LEVELING THE RANGE

The range must be level. Leveling feet are located at each corner of the base of the range. Remove the storage drawer or kick panel (depending on your model) and using channel locks, rotate the leveling feet in and out as required to level the range. (For instructions on how to remove and replace the storage drawer or the kick panel, see the Cleaning Under the Range section in Care and Cleaning.) On some models, there are plastic covers which may be removed for easy adjustment (just squeeze and pull).

One of the rear leveling feet will engage the ANTI-TIP bracket (allow for some side to side adjustment). Allow a minimum clearance of 1/8-inch between the range and the leveling foot that is to be installed into the ANTI-TIP bracket.

Check the range for proper installation into the ANTI-TIP bracket (after the range has been properly installed) by removing the kick panel or storage drawer and inspecting the rear leveling leg. Make sure it fits securely into the slot.

STEP 10

FINAL CHECK

Be sure all switches are in the OFF position before leaving the range.

QUESTIONS? USE THIS PROBLEM SOLVER



PROBLEM	POSSIBLE CAUSE
SURFACE UNITS WILL NOT MAINTAIN A ROLLING BOIL OR FRYING RATE IS NOT FAST ENOUGH	<ul style="list-style-type: none"> You must use pans which are absolutely flat. If light can be seen between the pan bottom and a straight edge, the elements will not transfer heat properly. Pan bottoms should closely match the diameter of the surface unit selected.
FOODS COOK SLOWLY	<ul style="list-style-type: none"> Improper cookware being used. Pan bottoms should be flat, fairly heavy-weight and the same diameter as the surface unit selected.
SURFACE UNITS DO NOT WORK PROPERLY	<ul style="list-style-type: none"> Difficulty may be in the main distribution panel of your house, caused by a blown oven-circuit fuse, a tripped oven-circuit breaker, the main fuse or the main circuit breaker, depending on the nature of the power supply. If a circuit breaker is involved, reset it. If the control box uses fuses, the oven fuse (a cartridge-type) should be changed, BUT ONLY BY SOMEONE FAMILIAR WITH ELECTRICAL CIRCUITS. If after performing one of these procedures, the fuse blows or circuit breaker trips again, call for service. NOTE: Apartment tenants or condominium owners should ask their building management to perform this check before calling for service. Cooktop surface unit controls are not properly set, or the wrong control knob is set for the surface unit you are using.
TINY SCRATCHES (may appear as cracks) OR ABRASIONS ON RADIANT COOKTOP GLASS SURFACE	<ul style="list-style-type: none"> Incorrect cleaning methods have been used, cookware with rough bottoms has been used, or coarse particles (salt or sand) were between the cookware and the surface of cooktop. Use recommended cleaning procedures, be sure cookware bottoms and cookware are clean before use and use cookware with smooth bottoms. Tiny scratches are not removable but will become less visible in time as a result of cleaning.
METAL MARKINGS (may appear as scratches)	<ul style="list-style-type: none"> Do not slide aluminum cookware across the surface. Use recommended cleaning procedure to remove marks. Incorrect cleaning materials have been used, encrusted boilovers or grease spatters remain on the surface. Use a razor scraper and recommended cleaning procedure.
DARK STREAKS OR SPECKS	<ul style="list-style-type: none"> Use a razor scraper and recommended cleaning procedure.
AREAS OF DISCOLORATION ON COOKTOP	<ul style="list-style-type: none"> Marks from aluminum and copper pans as well as mineral deposits from water or food can be removed with the cleaning cream.
HOT SUGAR MIXTURES/ PLASTIC MELTED TO THE SURFACE	<ul style="list-style-type: none"> See the Glass Cooktop Cleaning section.
FREQUENT CYCLING OFF AND ON OF SURFACE UNITS	<ul style="list-style-type: none"> Incorrect cookware used. Use only flat cookware to minimize cycling.

(continued next page)



PROBLEM SOLVER

(continued)

PROBLEM	POSSIBLE CAUSE
THE DISPLAY GOES BLANK OR INDICATOR LIGHTS COME ON WHEN THE RANGE IS NOT IN USE	<ul style="list-style-type: none">• Disconnect power to the range at the fuse box or circuit breaker for at least 10 seconds. Turn power on and power up your range. If the indicator lights are still on, call for service.
OVEN LIGHT DOES NOT WORK	<ul style="list-style-type: none">• Light bulb is loose or defective. Tighten or replace.• Switch operating oven light is broken. Call for service.
OVEN WILL NOT WORK	<ul style="list-style-type: none">• Plug on range is not completely inserted in the electrical outlet.• The circuit breaker in your house has been tripped, or a fuse has been blown.• Oven controls not properly set.• Door left in locked position after cleaning.
FOOD DOES NOT BROIL PROPERLY	<ul style="list-style-type: none">• The Oven Temperature knob not set at BROIL. Make sure you turn the knob all the way to the BROIL position.• Door not left open to the broil stop position as recommended.• Improper shelf position being used. See the Broiling Guide.• Food is being cooked on hot pan.• Cookware is not suited for broiling.• Aluminum foil used on the broil pan rack has not been fitted properly and slit as recommended.
FOOD DOES NOT ROAST OR BAKE PROPERLY	<ul style="list-style-type: none">• The Oven Temperature knob not set correctly.• Shelf position is incorrect. See the Roasting or Baking sections.• Oven shelf not level.• Incorrect cookware or cookware of improper size is being used.• A foil tent was not used when needed to slow down browning during roasting.• Oven thermostat needs adjustment. See the Adjust the Oven Thermostat—<i>Do It Yourself</i> section.
OVEN TEMPERATURE TOO HOT OR TOO COLD	<ul style="list-style-type: none">• Oven thermostat needs adjustment. See the Adjust the Oven Thermostat—<i>Do It Yourself</i> section.
CLOCK AND TIMER DO NOT WORK	<ul style="list-style-type: none">• Make sure the electrical plug is plugged into a live, properly grounded power outlet.• Check for power outage.• Review the Oven Control, Clock and Timer section of this guide.



PROBLEM	POSSIBLE CAUSE
OVEN WILL NOT SELF-CLEAN	<ul style="list-style-type: none">• Oven temperature is too high to set self-clean operation. Allow the range to cool to room temperature and reset the controls.• Control knob not set to AUTO SELF CLEAN.• Door latch handle not moved all the way to the right.
OVEN DOOR ACCIDENTALLY LOCKED DURING COOKING	<ul style="list-style-type: none">• Turn the Oven Temperature knob to OFF. Allow the oven to cool. Never force the door latch handle.
OVEN DOOR WILL NOT UNLOCK	<ul style="list-style-type: none">• Oven must cool below locking temperature.
OVEN NOT CLEAN AFTER CLEAN CYCLE	<ul style="list-style-type: none">• Oven controls not set properly.• Heavily soiled ovens may need to self-clean again or for a longer period.• Heavy spillovers should be cleaned before starting clean cycle.
LATCH DOOR LIGHT FLASHES	<ul style="list-style-type: none">• The Oven Temperature knob is set at auto self clean before the door latch handle is moved to the right.
OVEN DOOR IS CROOKED	<ul style="list-style-type: none">• Because the oven door is removable, it sometimes gets out of position during installation. To straighten the door, push down on the high corner.

If you need more help...call, toll free:
GE Answer Center®
800.626.2000
consumer information service

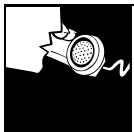

IF YOU NEED SERVICE...

We're proud of our service and want you to be pleased. If for some reason you are not happy with the service you receive, here are three steps to follow for further help.

FIRST, contact the people who serviced your appliance. Explain why you are not pleased. In most cases, this will solve the problem.

NEXT, if you are still not pleased, write all the details—including your phone number—to:

Manager, Consumer Relations GE Appliances
Appliance Park
Louisville, KY 40225

FINALLY, if your problem is still not resolved, write:

Major Appliance Consumer Action Program
20 North Wacker Drive
Chicago, IL 60606

We'll Be There

With the purchase of your new GE appliance, receive the assurance that if you ever need information or assistance from GE, we'll be there. All you have to do is call—toll-free!

GE Answer Center[®] **800.626.2000**

Whatever your question about any GE major appliance, GE Answer Center[®] information service is available to help. Your call—and your question—will be answered promptly and courteously. And you can call any time. GE Answer Center[®] service is open 24 hours a day, 7 days a week.

In-Home Repair Service **800-GE-CARES (800-432-2737)**

A GE consumer service professional will provide expert repair service, scheduled at a time that's convenient for you. Many GE Consumer Service company-operated locations offer you service today or tomorrow, or at your convenience (7:00 a.m. to 7:00 p.m. weekdays, 9:00 a.m. to 2:00 p.m. Saturdays). Our factory-trained technicians know your appliance inside and out—so most repairs can be handled in just one visit.

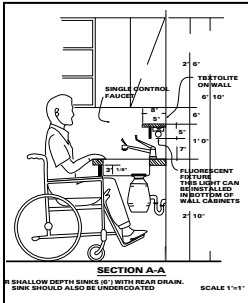

For Customers With Special Needs... **800.626.2000**

Upon request, GE will provide Braille controls for a variety of GE appliances, and a brochure to assist in planning a barrier-free kitchen for persons with limited mobility. To obtain these items, free of charge, call 800.626.2000.

Consumers with impaired hearing or speech who have access to a TDD or a conventional teletypewriter may call 800-TDD-GEAC (800-833-4322) to request information or service.

Service Contracts **800-626-2224**

You can have the secure feeling that GE Consumer Service will still be there after your warranty expires. Purchase a GE contract while your warranty is still in effect and you'll receive a substantial discount. With a multiple-year contract, you're assured of future service at today's prices.

Parts and Accessories **800-626-2002**

Individuals qualified to service their own appliances can have parts or accessories sent directly to their home. The GE parts system provides access to over 47,000 parts...and all GE Genuine Renewal Parts are fully warranted. VISA, MasterCard and Discover cards are accepted.

User maintenance instructions contained in this guide cover procedures intended to be performed by any user. Other servicing generally should be referred to qualified service personnel. Caution must be exercised, since improper servicing may cause unsafe operation.

YOUR GENERAL ELECTRIC RANGE WARRANTY

Staple sales slip or cancelled check here. Proof of original purchase date is needed to obtain service under warranty.

WHAT IS COVERED

FULL ONE-YEAR WARRANTY

For one year from date of original purchase, we will provide, free of charge, parts and service labor in your home to repair or replace **any part of the range** that fails because of a manufacturing defect.

LIMITED ADDITIONAL FOUR-YEAR WARRANTY

(Does not apply to JBP60)

For the second through fifth year from date of original purchase, we will provide, free of charge, a replacement glass cooktop due to:

- Cracking of the glass cooktop due to thermal shock
- Discoloration of the glass cooktop
- Wear off of the pattern on the glass cooktop
- Cracking of the rubber seal between the glass cooktop and the porcelain edge
- Burn out of any of the radiant surface units

For this limited additional four-year warranty, you pay for the service trip to your home and all service labor charges.

This warranty is extended to the original purchaser and any succeeding owner for products purchased for ordinary home use in the 48 mainland states, Hawaii and Washington, D.C. In Alaska the warranty is the same except that it is LIMITED because you must pay to ship the product to the service shop or for the service technician's travel costs to your home.

All warranty service will be provided by our Factory Service Centers or by our authorized Customer Care® servicers during normal working hours.

Should your appliance need service, during warranty period or beyond, call 800-GE-CARES (800-432-2737).

WHAT IS NOT COVERED

- Service trips to your home to teach you how to use the product.

Read your Use and Care material.

If you then have any questions about operating the product, please contact your dealer or our Consumer Affairs office at the address below, or call, toll free:

GE Answer Center®
800.626.2000
consumer information service

- Improper installation.
If you have an installation problem, contact your dealer or installer. You are responsible for providing adequate electrical, gas, exhausting and other connecting facilities as described in the Installation Instructions provided with the product.
- Replacement of house fuses or resetting of circuit breakers.

- Damage to the glass cooktop caused by use of cleaners other than the recommended cleaning cream provided with the product.
- Damage to the glass cooktop caused by hardened spills of sugary materials or melted plastic that are not cleaned according to the directions in the Use and Care Guide.
- Damage to the product due to misuse or abuse.
- Failure of the product if it is used for other than its intended purpose or used commercially.
- Damage to product caused by accident, fire, floods or acts of God.

WARRANTOR IS NOT RESPONSIBLE FOR CONSEQUENTIAL DAMAGES.

Some states do not allow the exclusion or limitation of incidental or consequential damages, so the above limitation or exclusion may not apply to you. This warranty gives you specific legal rights, and you may also have other rights which vary from state to state. To know what your legal rights are in your state, consult your local or state consumer affairs office or your state's Attorney General.

Warrantor: General Electric Company

**If further help is needed concerning this warranty, write:
Manager—Consumer Affairs, GE Appliances, Louisville, KY 40225**

This book is printed on recycled paper.

Part No. 164D2966P234

Pub No. 49-8723

10-95 CG

JBP60 JBP76
JBP65 JBP77
JBP75 JBP78

Printed in Louisville, KY