

DeLonghi

CORDLESS METAL TRADITIONAL KETTLE
BOLLITORE TRADIZIONALE IN METALLO SENZA FILO
BOUILLLOIRE TRADITIONNELLE EN MÉTAL SANS CORDON
CORDLESS WASSERKOCHER AUS EDELSTAHL
SNOERLOZE TRADITIONELE METALEN WATERKOKER
HERVIDOR TRADICIONAL DE METAL SIN FILTRO
FERVEDOR TRADICIONAL EM METAL SEM FIO
ΜΕΤΑΛΛΙΚΟΣ ΒΡΑΣΤΗΡΑΣ / ΚΑΝΑΤΑ ΧΩΡΙΣ ΚΑΛΩΔΙΟ

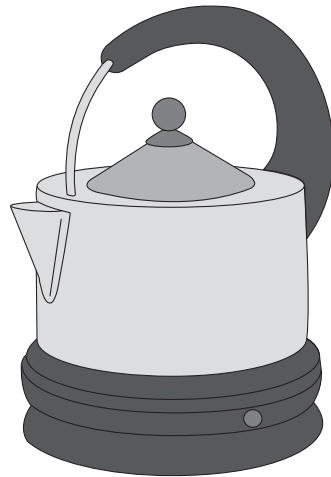

PC
ME 28

Instructions for use
Istruzioni per l'uso
Mode d'emploi
Gebrauchsanweisung
Gebruiksaanwijzing
Instrucciones para el uso
Instruções de uso
ΟΔΗΓΙΕΣ ΧΡΗΣΗΣ

ELECTRICAL REQUIREMENTS (ONLY FOR U.K.)

Before using this appliance ensure that the voltage indicated on the product corresponds with the main voltage in your home, if you are in any doubt about your supply contact your local electricity company.

The flexible mains lead is supplied connected to a B.S. 1363 fused plug having a fuse of 13 amp capacity. Should this plug not fit the socket outlets in your home, it should be cut off and replaced with a suitable plug, following the procedure outlined below.

Note: Such a plug cannot be used for any other appliance and should therefore be properly disposed of, (having removed the fuse) and not left where children might find it and plug it into a supply socket - with the obvious consequent danger.

If the plug is a moulded-on type the fuse cover must be refitted. If the fuse cover is lost, the plug must not be used until a replacement cover is obtained. The colour of the correct replacement fuse cover is that of the coloured insert in the base of the fuse recess or elsewhere on the plug. Always state this colour when ordering a replacement fuse cover.

N.B. We recommend the use of good quality plugs and wall sockets that can be switched off when the machine is not in use.

IMPORTANT: the wires in the mains lead fitted to this appliance are coloured in accordance with the following code:

GREEN AND YELLOW
BLUE
BROWN

EARTH
NEUTRAL
LIVE

As the colours of the wires in the mains lead of this appliance may not correspond with the coloured markings identifying the terminals in your plug, proceed as follows:

The wire which is coloured green and yellow must be connected to the terminal in the plug which is marked with the letter E or by the earth symbol \perp or coloured green or green and yellow.

The wire which is coloured blue must be connected to the terminal which is marked with the letter N or coloured black.

The wire which is coloured brown must be connected to the terminal which is marked with the letter L or coloured red.

When wiring the plug, ensure that all strands of wire are securely retained in each terminal. Do not forget to tighten the mains lead clamp on the plug. If your electricity supply point has only two pin socket outlets, or if you are in doubt, consult a qualified electrician.

Should the mains lead ever require replacement, it is essential that this operation be carried out by a qualified electrician and should only be replaced with a flexible cord of the same size.

Only 13amp replacement fuses which are ASTA approved to B.S. 1362 should be fitted.

This appliance conforms to the Norms EN 55014 regarding the suppression of radio interference.

WARNING - THIS APPLIANCE MUST BE EARTHED

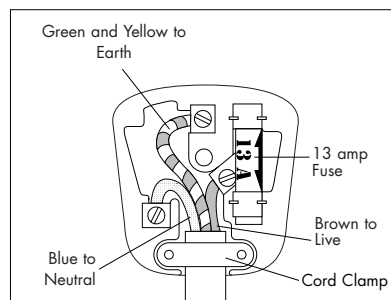

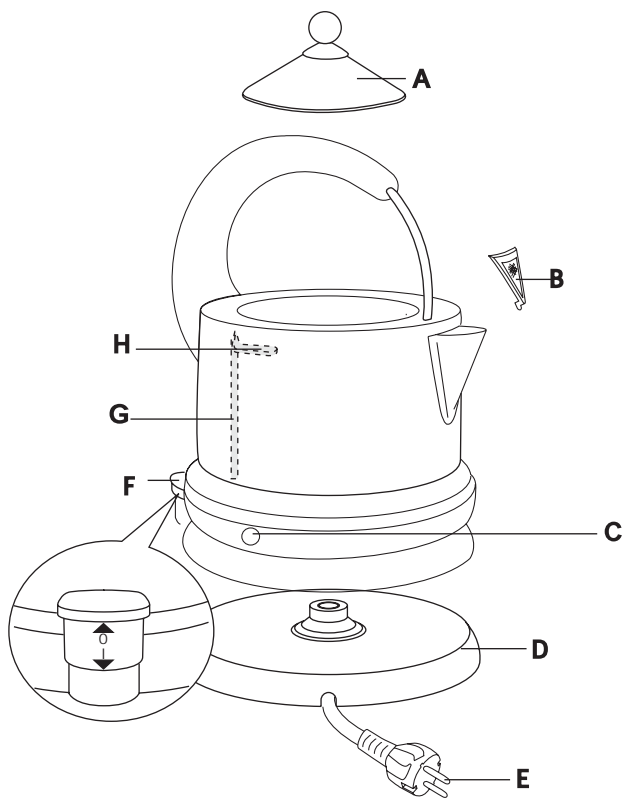

GB

- A LID
- B FILTER
- C PILOT LIGHT
- D 360° BASE WITH CORD ESTORAGE
- E PLUG
- F ON/OFF SWITCH
- G STEAM TUBE
- H MAX LEVEL INDICATOR

I

- A COPERCHIO
- B FILTRO
- C SPIA LUMINOSA
- D BASE A 360° CON AVVOLGICAVO
- E SPINA
- F PULSANTE DI ACCENSIONE ON/OFF
- G TUBICINO A VAPORE
- H INDICATORE DI LIVELLO MAX.

F

- A COUVERCLE
- B FILTRE
- C TÉMOIN LUMINEUX
- D SOCLE À 360° AVEC ENROULEUR DE CORDON
- E FICHE
- F INTERRUPTEUR MARCHÉ/ARRÊT ON/OFF
- G TUBE VAPEUR
- H INDICATEUR NIVEAU MAXIMAL

D

- A DECKEL
- B FILTER
- C KONTROLLEUCHTE
- D 360°-SOCKEL MIT KABELAUFWICKLUNG
- E NETZANSCHLUSS
- F EIN-AUS SCHALTER
- G DAMPFVENTIL
- H WASSERSTANDSANZEIGE MAX

NL

- A DEKSEL
- B FILTER
- C CONTROLLEAMPJE
- D 360°VOET MET SNOEROPBERGING
- E STEKKER
- F ON/OFF-SCHAKELAAR
- G STOOMPIJPJE
- H MAX. NIVEAU AANDUIDING

E

- A TAMPÁ
- B FILTRO
- C LAMPADA AVISADORA
- D BASE A 360° COM ENROLADOR DO CABO
- E FICHA
- F BOTÃO DE ON/OFF
- G TUBO DE VAPOR
- H INDICADOR DE NÍVEL MÁX.

P

- A TAPADERA
- B FILTRO
- C SEÑAL LUMINOSA
- D BASE A 360° CON RECOGECABLE
- E ENCHUFE
- F PULSADOR DE ENCENDIDO ON/OFF
- G TUBO DE VAPOR
- H INDICADOR DE NIVEL MÁX.

GR

- A ΚΑΠΑΚΙ
- B ΦΙΛΤΡΟ
- C ΕΝΔΕΙΚΤΙΚΗ ΛΥΧΝΙΑ
- D ΒΑΣΗ 360° ΜΕ ΧΩΡΟ ΑΠΟΘΗΚΕΥΣΗΣ ΚΑΛΩΔΙΟΥ
- E ΦΙΣ
- F ΔΙΑΚΟΠΤΗΣ ON/OFF
- G ΣΩΛΗΝΑΣ ΑΤΜΟΥ
- H ΕΝΔΕΙΞΗ MAX ΜΕΓΙΣΤΗΣ ΣΤΑΘΜΗΣ

IMPORTANT SAFEGUARDS

Please read these instructions before operating and retain for future reference.

- Ensure that your mains supply voltage is the same as that marked on the underside of your kettle.
- To protect against electrical hazards do not immerse the mains lead, plug power base or kettle in water or any other liquid. Do not use in the bathroom or near any source of water. Do not use outdoors.
- **Do not touch hot surfaces i.e. body or lid. Use handles or knobs.**
- Do not remove the lid while the kettle is boiling.
- Take care when pouring - do not over-tilt the kettle as water may enter into the switch mechanism.
- Water can remain hot for a long time after boiling, and can present a scald hazard. Keep the kettle and the mains lead away from the edge of the work surface and out of the reach of children.
- The appliance is not intended for use by young children or infirm persons without supervision.
- Young children should be supervised to ensure that they do not play with the appliance.
- Do not allow the mains lead to hang over the edge of the table or work surface, or anywhere it may be accidentally caught or tripped over.
- Close supervision is necessary when any appliance is used near children.
- Remove the plug from the mains socket when not in use and before cleaning. Allow the kettle to cool before cleaning.
- Remove the kettle from its power base before filling.
- Never move the kettle whilst it is in use.
- Caution: do not operate on an inclined surface.
- Do not move while switched on.
- Do not use the kettle if you have wet hands.
- Keep the kettle, the power base, and the mains lead away from hotplates, hobs or burners.
- Do not use the kettle for any purpose other than heating water. Do not place any utensils into the kettle. The use of accessory attachments not recommended by the appliance manufacturer may result in fire, electric shock or personal injury.
- Never use the kettle without it's lid.
- Position the kettle properly on the power base before switching on.
- Use the kettle only with the power base supplied (and vice versa).
- Do not operate this kettle if the mains lead or plug is damaged, if the kettle malfunctions, or has been damaged in any manner. It must be returned to a service agent for repair or replacement in order to avoid hazard.
- The power cable must not be replaced by the user, as this requires the use of special tools. If the power cable is damaged, contact an authorized Service Centre.
- If the kettle is overfilled, boiling water may overflow.

Failure to observe these cautions may result in damage to the kettle.

BEFORE USE

- Remove all packaging from the kettle and power base.
- Remove any labels from the outer stainless steel surfaces.
- Remove the filter by pushing as shown in fig. 1 and wash with water (fig. 2). Refer to page 7. "Removing the scale filter"
- Fill the kettle and boil.
- The boiled water should be discarded and the kettle rinsed out with cold water. This procedure should be carried out three times, to remove any manufacturing dust, etc.
- After the kettle has been rinsed out, re-fit the filter (fig. 3).

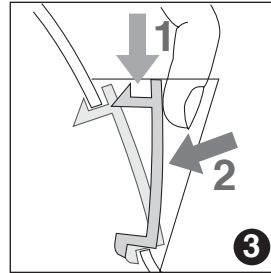
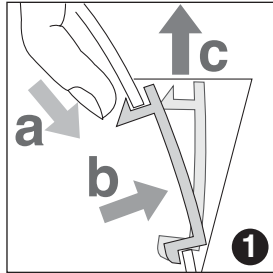

IN USE

Power base with 360° access

With the specially designed power base and central connector, you can now set the kettle on the base at any angle, from any position.

- Release cord from storage base and adjust length by winding around the base to give the correct cord length to reach the plug socket to be used (fig. 4).
- Do not leave loose cord hanging over the edge of work surfaces.

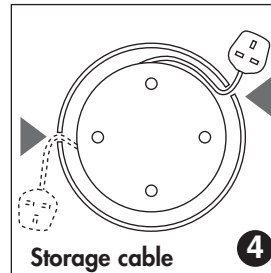

Filling

- Remove the kettle from the base unit before filling.
- Open lid and fill kettle to desired level.
Do not fill with less than 0,25 litre of water to prevent the kettle running dry while operating; misuse of this kind will shorten the life of the element.
Do not fill with more than 1,7 litres of water (up to the MAX indication located inside the kettle) (fig. 5). **If the kettle is overfilled, there is a risk that boiling water may be ejected causing burns.**

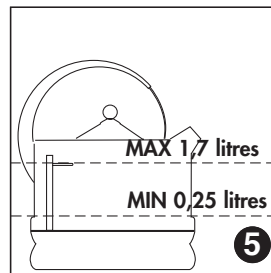

Switching on

- Plug the power base into the mains socket.
- Place kettle on power base.
- Press the ON/OFF switch down (fig. 6) to switch the kettle on.
- The pilot lights will switch on.
- The kettle will automatically switch off once the water is boiled (the ON/OFF switch will click upwards and the lights will go out).
- To turn the kettle off before the water boils, you may move the ON/OFF switch up to the OFF position, or simply lift the kettle from its base - it will switch off and the switch will return to the OFF position automatically.

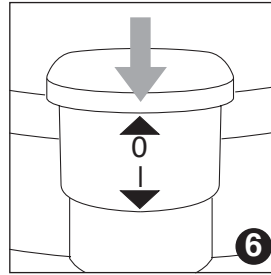

Pouring

- Remove the kettle from the power base and carefully pour out the water. Do not tilt kettle suddenly or pour out at too sharp an angle.
- When you lift the kettle from the base, you may see moisture on the top surface of the base. This is condensation from the steam that causes the kettle to turn off automatically after boiling. Steam is allowed to escape via vents in the underside of the kettle. **Condensation on the base is perfectly normal, and should not be a cause for alarm.**

SAFETY DEVICES

1) Automatic ON/OFF switch

Your kettle is fitted with an ON/OFF switch which automatically switches off once the water has boiled. If the kettle has just boiled, wait a minute or so before re-boiling the kettle. **Do not attempt to hold the ON/OFF switch in the ON position or adjust the switch mechanism.**

2) Safety cut-out

If the kettle is switched ON with too little or no water, it is protected against damage by a safety cut-out which will switch off the power.

If this cut-out operates, disconnect the kettle from the mains supply and **leave to cool down** before refilling with cold water (otherwise the element could be damaged).

3) If kettle is lifted from base while operating (ON), it will automatically switch off.

CARE AND MAINTENANCE

Cleaning the kettle

- Allow the kettle to cool down fully and disconnect the appliance from the mains before cleaning.
- Do not immerse the kettle or base in water.
- Use a soft dampened cloth to wipe the outside of the kettle and dry with a soft, dry cloth.
- DO NOT use metal polish or harsh scouring agents.
- Ensure that all connectors and sockets are kept dry.

Scale

Scale is mainly calcium carbonate (chalk), a harmless, naturally occurring mineral found in most water supplies. "Hard" water contains more of this mineral than "soft" water.

When the water is heated, the minerals in the water solidify, making the water appear cloudy. These minerals form a thin film on the walls, element and on the surface of the water. The water may look like it has white coloured pieces of plastic floating on the surface.

On traditional kettle elements, scale forms a hard white "crust" which adversely affects performance and reduces the life of the element.

As soon as you notice a film forming on the water, or, when cleaning the filter, if you notice a film on the walls or the element, simply rinse the kettle and wipe it out.

Scale filter

Your kettle is fitted with a scale filter to prevent loose particles of scale being poured into your beverage. This filter is both removable and washable.

The frequency with which you will need to clean any scale deposits from your filter will depend on the hardness of water in your area and how often you use the kettle.

You should remove and clean the water filter when you notice any deposits being left on the filter or if the pouring efficiency is impaired.

Removing the scale filter

- Allow the kettle to cool down fully.
- Disconnect the appliance from the mains electrical supply.
- Make sure that your hands are clean and free from soap, cream or anything which might taint the water.
- Empty the kettle and remove the filter by pushing as shown in fig. 1.
- Rinse under a tap whilst brushing with a soft brush (fig. 2).
- Replace the filter (fig. 3).

To clean the scale filter

It is vital to clean and descale regularly in order to maintain good working order

- Use a proprietary descaling product e.g. citric acid crystals.
We recommend using citric acid crystals as follows:
- Pour into kettle about 50 gr. or 2 oz. of citric acid crystal and then fill with water up to the max level indicated and then boil. Allow the contents to cool, and then rinse thoroughly.
- Do not use a more concentrated solution. If the filter requires descaling, remove the filter and place into the citric acid solution.
- Ensure that the electrical connections are completely dry before using the kettle.
- Citric acid crystals are available from most pharmacies.