

L53H4/US (VCC-6594) GB 2001, 11, 9

## INSTRUCTION MANUAL

### COLOR CCD CAMERA

**SANYO**  

---

**VCC-6594**

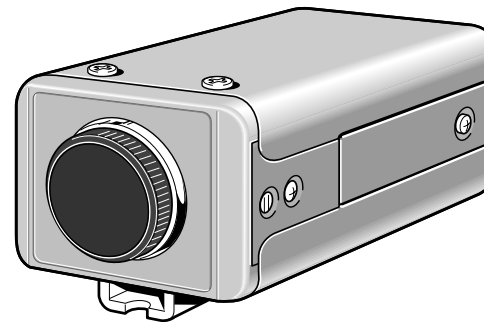

#### **About this manual**

Before installing and using the camera, please read this manual carefully. Be sure to keep it handy for later reference.

L53H4/US (VCC-6594) GB 2001, 11, 9

**SANYO INDUSTRIAL VIDEO  
COLOR VIDEO CAMERA LIMITED WARRANTY**

**OBLIGATIONS**

In order to obtain warranty service, the product must be delivered to and picked up from an Authorized Sanyo Service Center at the user's expense, unless specifically stated otherwise in this warranty. The names and addresses of Authorized Sanyo Service Centers may be obtained by calling the toll-free number listed below.

For product operation, authorized service center referral, service assistance or problem resolution, call

**CUSTOMER INFORMATION 1-800-421-5013**  
**Weekdays 8:30 AM – 5:00 PM Pacific Time**

For accessories and/or parts, call

**PARTS ORDER INFORMATION 1-800-726-9662**  
**Weekdays 8:30 AM – 5:00 PM Pacific Time**

THIS WARRANTY IS VALID ONLY ON SANYO PRODUCTS PURCHASED OR RENTED IN THE UNITED STATES OF AMERICA, EXCLUDING ALL U.S. TERRITORIES AND PROTECTORATES. THIS WARRANTY APPLIES ONLY TO THE ORIGINAL RETAIL PURCHASER OR END-USER. THE ORIGINAL DATED BILL OF SALE, SALES SLIP OR RENTAL AGREEMENT MUST BE SUBMITTED TO THE AUTHORIZED SANYO SERVICE CENTER AT THE TIME WARRANTY SERVICE IS REQUESTED.

Subject to the OBLIGATIONS above and EXCLUSIONS below, SANYO Fisher Company warrants this SANYO product against defects in materials and workmanship for the periods specified below. SFC will repair or replace (at its option) the product and any of its parts which fail to conform to this warranty. The warranty period commences on the date the product was first purchased or rented at retail.

LABOR	PARTS	IMAGE DEVICE
3 YEARS	3 YEARS	3 YEARS

**EXCLUSIONS**

This warranty does not cover (A) the adjustment of customer-operated controls as explained in the appropriate model's instruction manual, or (B) the repair of any product whose serial number has been altered, defaced or removed.

This warranty shall not apply to the cabinet or cosmetic parts, batteries or routine maintenance.

This warranty does not apply to uncrating, setup, installation, removal of the product for repair or reinstallation of the product after repair.

This warranty does not apply to repairs or replacements necessitated by any cause beyond the control of SFC including, but not limited to, any malfunction, defect or failure caused by or resulting from unauthorized service or parts, improper maintenance, operation contrary to furnished instructions, shipping or transit accidents, modification or repair by the user, abuse, misuse, neglect, accident, incorrect power line voltage, fire, flood or other Acts of God, or normal wear and tear.

The foregoing is in lieu of all other expressed warranties and SFC does not assume or authorize any party to assume for it any other obligation or liability.

SFC DISCLAIMS ALL OTHER WARRANTIES EXPRESS OR IMPLIED, WITH REGARD TO THIS PRODUCT (INCLUDING THE WARRANTIES OF MERCHANTABILITY AND FITNESS). IN NO EVENT SHALL SFC BE LIABLE FOR ANY SPECIAL, INCIDENTAL OR CONSEQUENTIAL DAMAGES ARISING FROM THE OWNERSHIP OR USE OF THIS PRODUCT OR FOR ANY DELAY IN THE PERFORMANCE OF ITS OBLIGATIONS UNDER THIS WARRANTY DUE TO CAUSES BEYOND ITS CONTROL. SFC'S LIABILITY FOR ANY AND ALL LOSSES AND DAMAGES RESULTING FROM ANY CAUSE WHATSOEVER, ARISING OUT OF OR IN CONNECTION WITH THE SALE, USE OR OWNERSHIP OF THIS PRODUCT INCLUDING WARRANTOR'S NEGLIGENCE, ALLEGED DAMAGED OR DEFECTIVE GOODS, WHETHER SUCH DEFECTS ARE DISCOVERABLE OR LATENT, SHALL IN NO EVENT EXCEED THE PURCHASE PRICE OF THE PRODUCT.

**ATTENTION**

For your protection in the event of theft or loss of this product, please fill in the information below for you own personal records.

**Model No.** \_\_\_\_\_ **Serial No.** \_\_\_\_\_  
(Located on back or bottom side of unit.)

**Date of Purchase** \_\_\_\_\_ **Purchase Price** \_\_\_\_\_

**Where Purchased** \_\_\_\_\_



L53H4/US (VCC-6594) GB 2001, 11, 9



1AC6P1P2413--  
L53H4/US(1101KPS-CZ)



**SANYO**

21605 Plummer Street,  
Chatsworth, California 91311  
Printed in Japan

Depending on the conditions of use, installation and environment, please be sure to make the appropriate settings and adjustments. If you need help with installation and/or settings, please consult your dealer.

## CONTENTS

<b>INFORMATION TO USER</b> .....	<b>2</b>
<b>PRECAUTIONS</b> .....	<b>3</b>
<b>PARTS NAMES</b> .....	<b>4</b>
<b>CONCERNING AUTO-IRIS LENSES</b> .....	<b>7</b>
<b>MOUNTING THE LENS</b> .....	<b>8</b>
<b>CONNECTIONS</b> .....	<b>10</b>
<b>SETTINGS</b> .....	<b>11</b>
<b>TROUBLESHOOTING</b> .....	<b>16</b>
<b>SPECIFICATIONS</b> .....	<b>17</b>

## ACCESSORIES

① Lens iris plug (4-pin).....	1 pc.
-------------------------------	-------

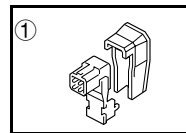

## FEATURES

- Built-in interline transfer method 1/3" CCD, approx. 410,000 picture elements
- Equipped with a DSP (Digital Signal Processor) function
- Horizontal resolution, more than 520 TV lines
- High sensitivity, minimum required illumination is 0.3 lux (F1.2, AGC HI position)
- Two types of backlight compensation functions (multi-spot photometry and center focus photometry)
- Low smear, anti-blooming, low lag, no burning and no geometric distortion using the CCD solid state image device.
- 100% solid state components giving excellent immunity to shock and vibration
- Not subject to interference from magnetic or electrostatic fields
- Power supply: 24 V AC operation

## INFORMATION TO USER

### *Safety Guard*



**THIS SYMBOL INDICATES THAT THERE ARE IMPORTANT OPERATING AND MAINTENANCE INSTRUCTIONS IN THE LITERATURE ACCOMPANYING THIS UNIT.**

**WARNING:**

**TO PREVENT THE RISK OF FIRE OR ELECTRIC SHOCK , DO NOT EXPOSE THIS APPLIANCE TO RAIN OR MOISTURE.**

**For the customers in Canada**

This Class B digital apparatus complies with Canadian ICES-003.

**Pour la clientèle canadienne**

Cet appareil numérique de la Classe B est conforme à la norme NMB-003 du Canada.

This installation should be made by a qualified service person and should conform to all local codes.

This equipment has been tested and found to comply with the limits for a Class B digital device, pursuant to Part 15 of the FCC Rules.

These limits are designed to provide reasonable protection against harmful interference in a residential installation. This equipment generates, uses, and can radiate radio frequency energy and, if not installed and used in accordance with the instructions, may cause harmful interference to radio communications.

However, there is no guarantee that interference will not occur in a particular installation. If this equipment does cause harmful interference to radio or television reception, which can be determined by turning the equipment off and on, the user is encouraged to try to correct the interference by one or more of the following measures:

- Reorient or relocate the receiving antenna.
- Increase the separation between the equipment and receiver.
- Connect the equipment into an outlet on a circuit different from that to which the receiver is connected.
- Consult the dealer or an experienced radio/TV technician for help.

This device complies with Part 15 of the FCC Rules. Operation is subject to the following two conditions: (1) This device may not cause harmful interference, and (2) this device must accept any interference received, including interference that may cause undesired operation.

Changes or modifications not expressly approved by **Sanyo** may void the user's authority to operate this camera.

## PRECAUTIONS

---

### ■ In case of problem

Do not use the camera if smoke or a strange odour comes from the unit, or if it seems not to function correctly. Disconnect the power cord immediately, and consult your dealer (or a Sanyo Authorized Service Centre).

### ■ Do not open or modify

Do not open the cabinet, as it may be dangerous and cause damage to the unit. For internal settings and repairs, consult your dealer (or a Sanyo Authorized Service Centre).

### ■ Do not put objects inside the unit

Make sure that no metal objects or flammable substance get inside the camera. If used with a foreign object inside, it could cause a fire, short-circuits or damages.

If water or a liquid gets inside the camera, disconnect the power cord immediately, and consult your dealer (or a Sanyo Authorized Service Centre). Be careful to protect the camera from rain, sea water, etc.

### ■ Be careful when handling the unit

To prevent damages, do not drop the camera or subject it to strong shock or vibration.

### ■ Install away from electric or magnetic fields

If installed close to a TV, radio transmitter, magnet, electric motor, transformer, audio speakers the magnetic field they generate will distort the image.

### ■ Protect from humidity and dust

To prevent damages to the camera, do not install it where there is greasy smoke or steam, where the dampness may get too high, or where there is a lot of dust.

### ■ Protect from high temperatures

Do not install close to stoves, or other heat generating devices, such as spotlights, etc., or where it could be subject to direct sunlight, as that could cause deformation, discoloration or other damages.

Be careful when installing close to the ceiling, in a kitchen or boiler room, as the temperature may raise to high levels.

Install where the temperature range will stay between  $-10^{\circ}\text{C}$  and  $50^{\circ}\text{C}$ .

(no condensation)

### ■ Cleaning

- Dirt can be removed from the cabinet by wiping it with a soft cloth. To remove stains, wipe with a soft cloth moistened with a soft detergent solution and wrung dry, then wipe dry with dry soft cloth.
- Do not use benzine, thinner or other chemical product on the cabinet, as that may cause deformation and paint peeling. Before using a chemical cloth, make sure to read all accompanying instructions. Make sure that no plastic or rubber material comes in contact with the cabinet for a long period of time, as that may cause damage or paint peeling.

## PARTS NAMES

---

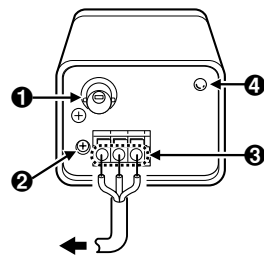

**❶ Video output connector (VIDEO OUT: BNC type)**

Connect this connector to a device such as a VCR or monitor with a **VIDEO IN** connector.

**❷ Line phase adjustment volume (LINE PHASE)**

When using two cameras or more, the image on the monitor may roll vertically when switching sources. This rolling can be minimized by turning this volume.

**❸ Power input terminal**

24 V AC input terminal (AC 24 V, GND)

**❹ Power indicator (POWER)**

Comes on when the power to the camera is on.

## PARTS NAMES

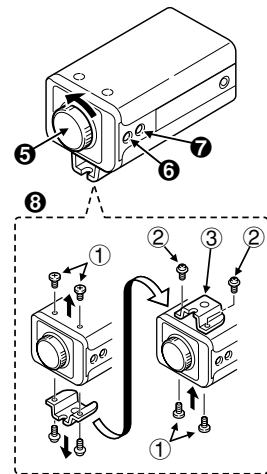

- ① Shorter screws: M3 x 4
- ② Longer screws: M3 x 6
- ③ Camera mounting screw hole: 1/4"-20 UNC

### ⑤ Lens mount cap

The cap is installed to protect the lens mount section.  
Remove the lens mount cap before installing a lens (sold separately).

### ⑥ Flange-back adjustment screw (FLANGE BACK ADJ.)

### ⑦ Flange-back lock screw (FLANGE BACK LOCK)

### ⑧ Camera installation bracket

The bracket can be fixed at the top or bottom of the camera. When fixing the bracket, be sure to use the longer screws and install the shorter screws on the opposite side to seal the openings.

### CAUTION:

When installing the camera support, select a location that can support the total weight of the camera and accessories.



## PARTS NAMES

---

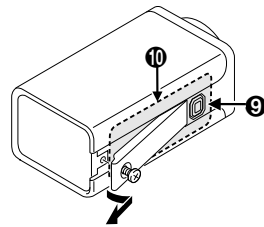

### 9 Lens iris output connector (LENS)

This 4-pin connector is used to send the DC control signal and power supply to an auto-iris type lens.

### 10 Camera setup section (under the cover)

These settings are for when using a 1/3 inch CS mount **DC** (without **EE** internal amplifier) type lens. However, if due to installation conditions or environment the settings may need to be modified for best results (see "**SETTINGS**"). To access the controls, remove the cover fixing screw, then remove the cover.

**NOTE:** When using a 1/2 or 2/3 inch C mount **VIDEO** (with **EE** internal amplifier) auto-iris type lens, set the **A.I. LENS** switch to the **VIDEO** position.

## CONCERNING AUTO-IRIS LENSES

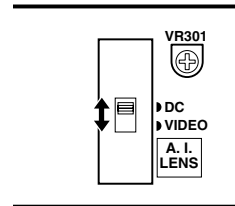

### ■ DC type auto-iris lens

A lens without amplifier circuit that operates only on a DC power source. In general, this type of lens is referred to as DC type coil lens or DC type non-amplifier lens.

(Set the **A.I. LENS** switch to the **DC** position.)

### ■ VIDEO type auto-iris lens

A lens with amplifier circuit that operates on video signal and DC power source. In general, this type of lens is referred to as EE amplifier type lens.

ALC and LEVEL volume level controls are available on the lens for iris adjustments.

(Set the **A.I. LENS** switch to the **VIDEO** position.)

### ■ Compatible auto-iris lenses

1/3 inch Sanyo DC type lens	VIDEO type lens
VCL-CS8LY: Standard angle, f= 8 mm	Standard angle, f= 9 mm
VCL-CS4LY: Wide angle, f= 4 mm	Telephoto angle, f= 12 mm
VCL-CS2LY: Ultra-wide angle, f= 2.8 mm	Greater telephoto angle, f= 16 mm

### ■ If using a VIDEO type auto-iris lens

- Set the **ALC** and **LEVEL** controls on the lens to adjust the iris. Normally the **ALC** volume should be turned all the way to **Av** (Average).
- Depending on the type of lens used, the lens may not perform properly. In such a case, adjust the **LEVEL** volume on the lens casing to correct.

## MOUNTING THE LENS

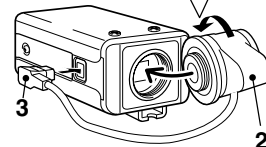
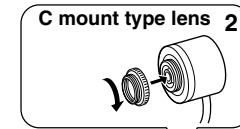
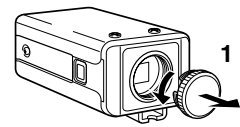

CS mount type lens

Please use a DC type auto-iris lens (sold separately).

### Check the lens mount

Do not use a lens if the length "L" is more than 5 mm. That may damage the camera and prevent proper installation.

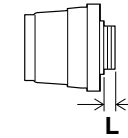

1 Remove the lens mount cap from the camera.

2 Install the auto-iris lens.

### CS mount type lens

Carefully align the lens mount with the camera opening, then turn the lens slowly to install it.

### C mount type lens

To allow for flange-back adjustment, install the C-mount adaptor (option) on the lens mount, then carefully align the lens mount with the camera opening and turn the lens slowly to install it.

3 Connect the lens plug to the lens iris output connector (LENS) on the side of the camera.

When using lenses from other makers, the plug shape may not correspond to the terminal on the camera. In such a case, remove the original plug and using a soldering iron, connect the supplied lens iris plug according to the diagram. (Refer to page 9.)

## MOUNTING THE LENS

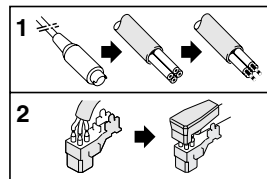

### ■ Rewiring the lens cable in the lens iris plug

#### 1 Prepare the lens cable.

Cut the cable at the plug, then remove approx. 8 mm of the cable sheath and strip about 2 mm from each wire.

#### 2 Install the lens iris plug.

Solder the cable to the pins following the correct pin layout (refer to the table and illustrations), then close the plug cover.

#### Pin layout

	DC type lenses	VIDEO type lenses
①	Brake coil (-)	+12 V DC (50 mA max.)
②	Brake coil (+)	Not used
③	Drive coil (+)	Video output (1.0 Vp-p, high impedance)
④	Drive coil (-)	Ground (for video signal and DC power)

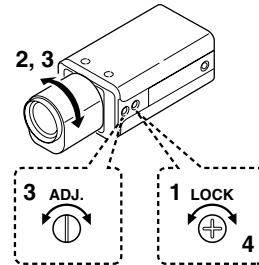
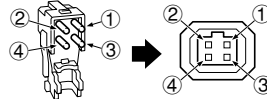

### ■ Flange-back adjustment

If the pick-up surface is not correctly positioned with relation to the lens focal point, the picture will be out of focus (in particular when using auto-iris power zoom lenses, sold separately). If that is the case, adjust the flange-back position as described below.

- 1 Using a + screwdriver, loosen the **FLANGE BACK LOCK** screw (M2+).
- 2 Set the zoom lens to the maximum telephoto position, set the focus using the focus ring on the lens.
- 3 Set the zoom lens to the maximum wide angle position, set the focus using the **FLANGE BACK ADJ.** screw.
- 4 Repeat steps 2 and 3, until the image stays in focus when changing from a telephoto shot to a wide angle shot. When the setting is complete, tighten the **FLANGE BACK LOCK** screw.

## CONNECTIONS

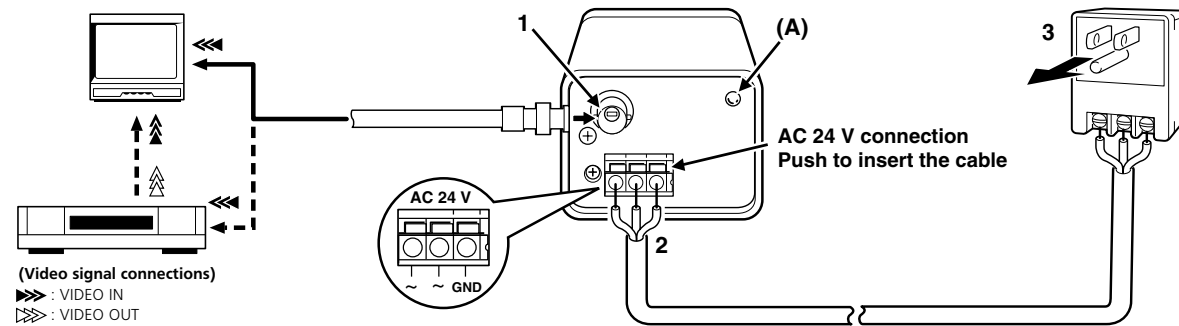

### Basic connection for monitoring or recording

The peripheral devices (VCR, monitor, lens, etc.), AC adaptor and cables are sold separately.

- 1 Make the video signal connection between the camera and the monitor or time lapse VCR.**
- 2 Use a commercially available 24 V AC adaptor.**  
Connect an AC 24 V power source to the **AC 24 V** input terminal on the back of the camera.
- 3 Insert the plug of this power cord into a wall outlet.**  
The **POWER** indicator (**A**) will light. Adjust the picture on the monitor using the Brightness and Contrast controls etc.

### Coaxial cable type and maximum length

- Cable type RG-59U (3C-2V), 250 m maximum.
- Cable type RG-6U (5C-2V), 500 m maximum.
- Cable type RG-11U (7C-2V), 600 m maximum.

### CAUTION:

- The RG-59U type cable should not be run through electrical conduits or through the air.
- Using CCTV/Video-grade coaxial cable.

## SETTINGS

The illustration shows the factory default settings for the switches in the camera setup section.

The camera settings are described on the assumption that a DC type auto iris lens is being used. If you are using a VIDEO type auto iris lens, be sure to read the Note which is given.

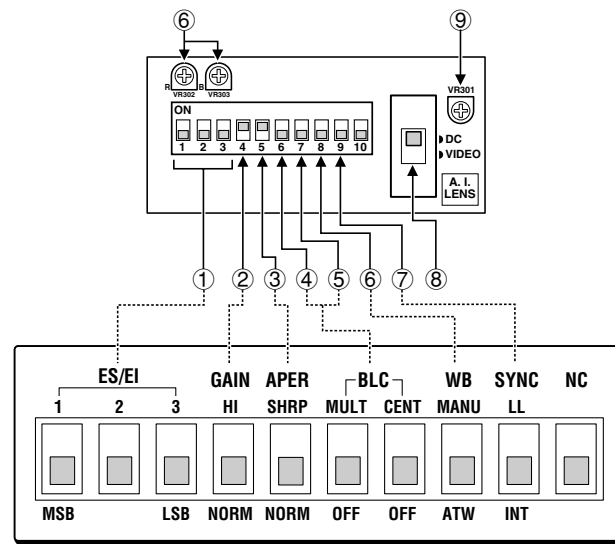

\* The sticker on the inside of cover.

## SETTINGS

### ■ Electronic shutter settings and electronic iris settings

When all of these switches are down, electronic shutter (1/60 sec or auto iris setting) is enabled. The electronic shutter can be set to one of 7 speeds as shown in **Table A**.

Furthermore, when all switches are up, electronic iris setting is enabled.

#### Notes on the electronic shutter:

- Using the high speed electronic shutter indoors with low lighting, will give darker pictures. In such a case, add some lights to make sure the lighting is sufficient. If the lighting is very bright, pay attention to the light angle in order to avoid or minimize the smear phenomenon effect.
- Use a manual or fixed iris lens and set the lens aperture to the shortest F stop. Set the switch (1 – 3) to the up position.
- The electronic iris is suitable for normal indoor use. When the switch (1 – 3) is set to the up position, do not use an auto-iris lens.
- If used under fluorescent light, the image may flicker. In such a case, change to incandescent lighting or set the switch (1 – 3) to the down position and use an auto-iris lens.
- If conditions are outside the electronic iris operation range or more than the maximum illumination, it will cause saturation of the CCD. In that case, use a manual iris lens.

Table A (switch 1 ~ 3)

①	②	③	④	⑤	⑥	⑦	⑧
1/60(AI)	1/100	1/500	1/1000	1/2000	1/4000	1/10000	EI

(Unit: sec.)

### ■ Automatic Gain Control (AGC) setting

The automatic gain control can be turned **HI** or **NORM** using the AGC switch 4 in the camera setup section.

**HI:** Auto gain control function on (+6 dB)

**NORM:** Auto gain control (normal gain)



**Note:** In the AGC switch position **HI**, noise may be noticed in dark places of dimly lit objects. In the AGC switch position **NORM**, the noise will be reduced, but the sensitivity will also be reduced to half in this case.

### ■ Aperture

This switch **5 (APER)** is normally set to the down (**NORM**) position. If you would like to emphasize the contours of the object, set the switch **5 (APER)** to the up (**SHRP**) position.



## SETTINGS

### ■ Backlight compensation setting

This camera has two different backlight compensation functions: Normally backlight compensation switch **6 (MULT)** and **7 (CENT)** are set to the down (**OFF**) position. Change the backlight compensation switch settings depending on the conditions.

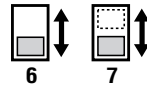

- **MULT mode:** Use this position when applying backlight compensation to the whole of the screen.
- **CENT mode:** Use this position when applying backlight compensation to only the central portion of the screen.

#### Note:

- If switches **6** and **7** are set to the up (**ON**) position at the same time, the **MULT** setting will have priority.
- When **MULT** mode is set, scenes with no backlighting may appear extremely dark and the object may appear over-exposed. If this happens, set to **CENT** mode.

#### (MULT mode: 64 sections)

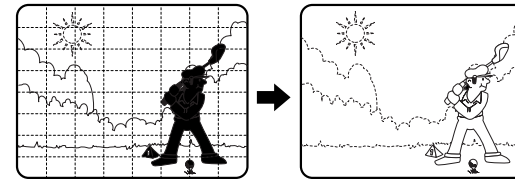

#### (CENT mode)

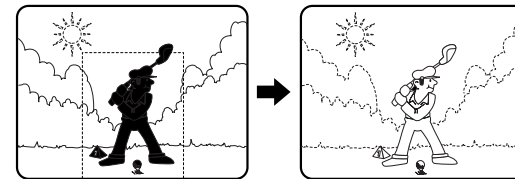

#### If using a VIDEO type auto-iris lens

- The **ALC** volume on the lens should be turned all the way to **Av** (Average).
- If the backlight compensation function does not compensate properly for the conditions, set using the **LEVEL** volume on the lens.



## SETTINGS

### ■ White balance adjustment

Normally the switch **8 (WB)** is set to the down (**ATW**: auto white balance) position and the white balance is adjusted automatically. If a manual white balance adjustment is necessary, follow the steps below. Set the switch **8 (WB)** to the up (**M**: manual) position, then adjust the colour.

- Turn **RED** (VR302) to set the red ratio and/or **BLUE** (VR303) to set the blue ratio.



### ■ Lens iris adjustment

If using a DC type auto-iris lens, you will need to set the **LEVEL** (VR301) volume when shooting in the conditions described below.



**L (counterclockwise):** To decrease the contrast

**H (clockwise):** To increase the contrast

- If shooting simultaneously in a dark room and through a bright window.
- If the subject background is extremely bright or dark.
- If the brightness of the picture on the monitor is not correct.

## SETTINGS

### ■ Line phase adjustment

When using a camera switcher to connect 2 cameras or more to one monitor, there may be a vertical roll of the images when switched. In such a case, set as described below.

- 1 Set the switch **9 (SYNC)** to the up (**LL**) position.
- 2 Switch the display on the monitor from camera 1 to camera 2.  
Adjust the **LINE PHASE** volume on camera 2 until the vertical roll of the image stops.  
If more than two cameras are used, please repeat this procedure for all the cameras.

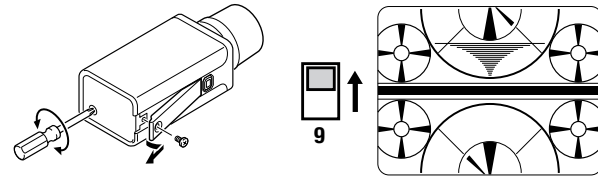

#### CAUTION:

If the vertical roll cannot be corrected by setting the **LINE PHASE** volume on camera 2, try setting the **LINE PHASE** volume on camera 1. If it still cannot be corrected, please check that the polarity of the power cords of all connected devices is correct.

## TROUBLESHOOTING

---

Before taking the camera for repairs, please check below to make sure that the camera is used correctly. If it still does not perform correctly, please consult your dealer or a Sanyo Authorized Service Centre.

### ■ No picture on the monitor screen

- Is the power turned on to all connected devices? Is the voltage correct?
- Are all the signal connecting cables correctly connected?
- Is the lighting sufficient?
- Has the lens cap been removed?
- Is the lens type (**DC** or **VIDEO**) correctly selected?  
Depending on the type of lens, the **A. I. LENS** switch must be set accordingly.
- Is the iris control correctly set?

### ■ The picture is not clear

- Is the monitor correctly adjusted?
- Is the flange-back position correctly set?
- Is the lens focus correctly adjusted?
- Are the lens surfaces clean?

If there is dust or finger prints on the lens, the image quality will deteriorate. To clean the lens use a soft cloth or a commercially available lens cleaning set.

### SERVICE

This camera is a precision instruments and if treated with care, will provide years of satisfactory performance. However, in the event of a problem, the owner is advised not to attempt to make repairs or open the cabinet. Servicing should always be referred to your dealer or Sanyo Authorized Service Centre.

## SPECIFICATIONS

### ■ Camera:

<b>Scanning system</b>	: NTSC standard TV system (525 TV lines, 30 frames/sec.)
<b>Interlace</b>	: PLL 2:1 interlace
<b>Image device</b>	: 1/3 inch solid state image device CCD
<b>Picture elements</b>	: 811 (H) x 508 (V)
<b>Effective picture elements</b>	: 768 (H) x 494 (V)
<b>Synchronizing system</b>	: Internal sync, Line lock manually switchable
<b>Resolution</b>	: 520 TV lines horizontally, 350 TV lines vertically
<b>Video output level</b>	: 1.0 Vp-p/75 ohms, composite
<b>Video S/N ratio</b>	: More than 48 dB
<b>Minimum required illumination (incandescent lighting)</b>	: Approx. 0.3 lux with a F 1.2 lens (AGC, HI) Approx. 0.6 lux with a F 1.2 lens (AGC, NORM)
<b>Backlight compensation</b>	: Manual MULT/CENT/OFF switching (Active when using an auto-iris lens)
<b>Iris function</b>	: AI/EI selectable by switches (Electronic shutter)
<b>Electronic iris range</b>	: 0.6 lux to 50,000 lux (F 1.2 lens)
<b>Electronic shutter</b>	: 7 speeds, selectable by switches: (1/60, 1/100, 1/500, 1/1000, 1/2000, 1/4000, 1/10000 sec.)
<b>Flange-back</b>	: 12.5 mm ± 0.5 mm
<b>White balance</b>	: ATW/Manual switching
<b>Lens mount</b>	: CS mount
<b>AGC</b>	: HI/NORM
<b>Environmental conditions</b>	: Temperature: -10 °C ~ +50 °C Humidity: less than 90% (no condensation)

<b>Power supply</b>	: 24 V AC, 60 Hz
<b>Power consumption</b>	: Approx. 2.8 W (with auto iris lens) Approx. 2.1 W (without auto iris lens)
<b>Weight</b>	: Approx. 310 g (without lens)

### ■ Dimensions

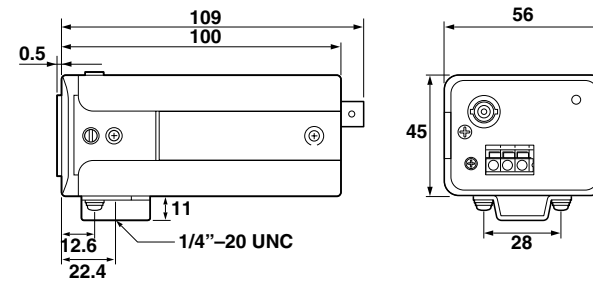

Features and specifications are subject to change without prior notice or obligations.